

This drawing is confidential and must not be reproduced or used without the consent of EXM

Ce dessin est confidentiel et ne doit pas être reproduit ou utilisé sans le consentement de EXM

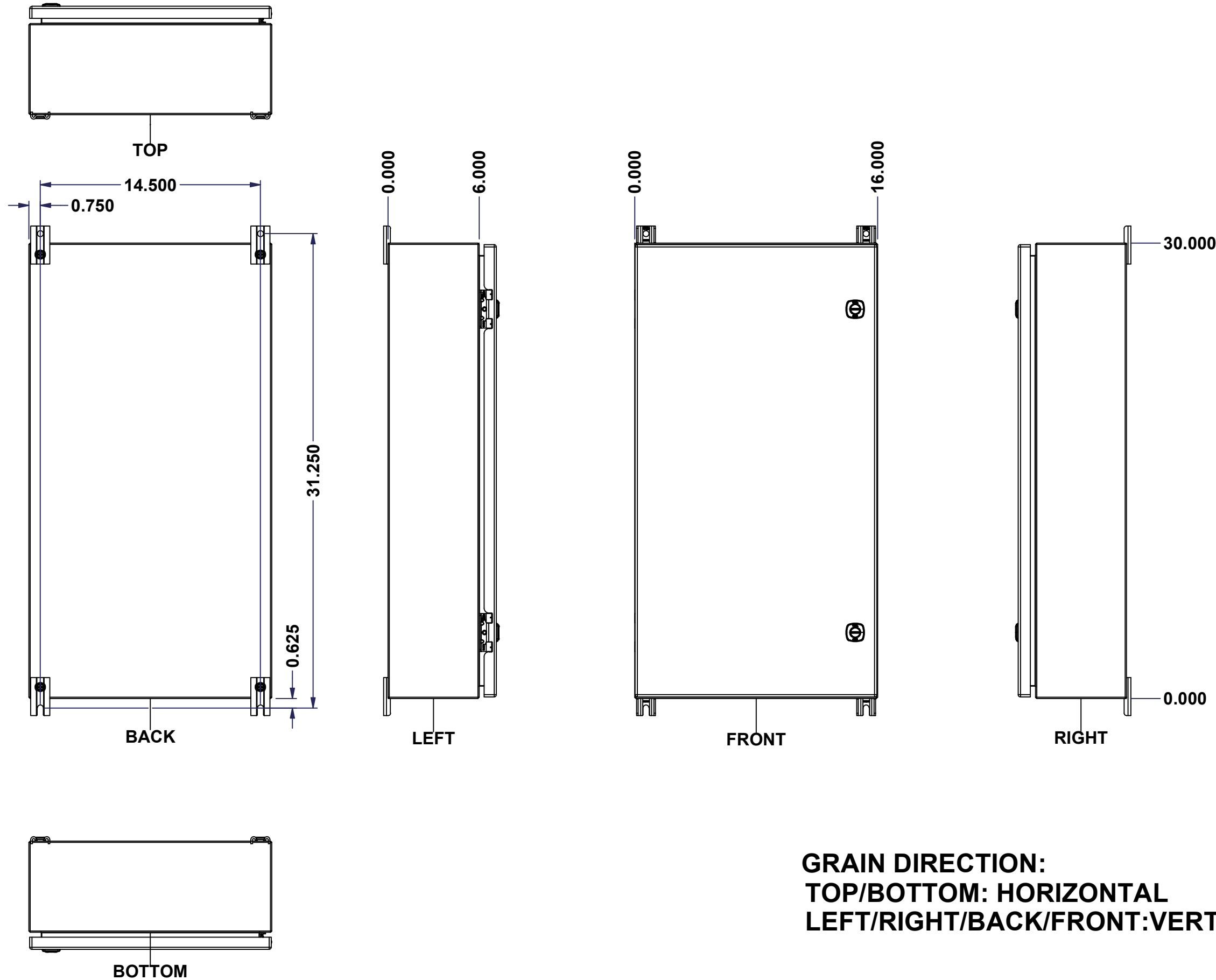

No.	Revisions	Date	By/Par

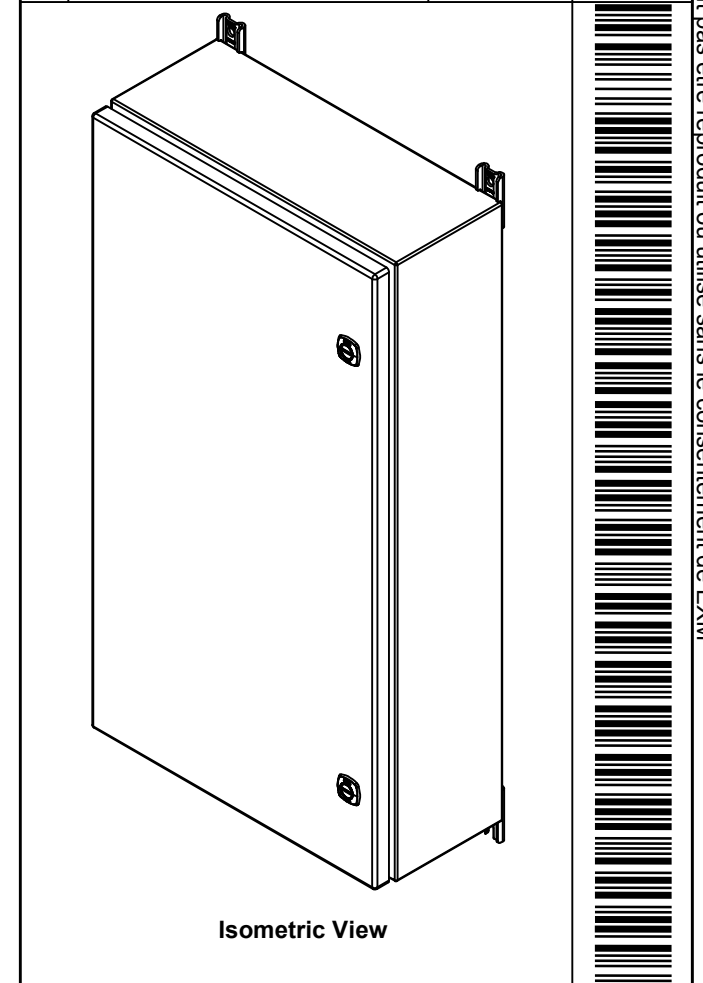

**GRAIN DIRECTION:
TOP/BOTTOM: HORIZONTAL
LEFT/RIGHT/BACK/Front: VERTICAL**

Tél: (450) 979-4373 Fax: (450) 979-4626 www.exmweb.com		Flatness Aplatissement Max 3.0mm Projection
Customer Client	Date	
Drawn By Dessiné Par	BoxCad: BoxCad	Date 30-May-23
Material Matière	16 Ga Stainless Steel 316 (1.4mm)	
Color Couleur	Unpainted	Finish Fini Brushed
Description	Detail Rev.	
5412ESS 30" x 16" x 6" Assembly		
Part Number Numéro Pièce	Rev. 0	1 16

SEE BILL OF MATERIAL ON LAST PAGE **5412ESS3016066THNOIP**

This drawing is confidential and must not be reproduced or used without the consent of EXM

Ce dessin est confidentiel et ne doit pas être reproduit ou utilisé sans le consentement de EXM

NOTE	
ITEM	DESCRIPTION
1	NEMA 4X Enclosure
2	C/W Standard ground studs on box and cover
3	C/W Standard door stiffener
4	W/O Inner panel
5	C/W Standard inner panel mounting studs
6	C/W 885 ESMF4_OPEN Sold separately (Installed)
7	C/W 885 ESMF4_CLOSE Sold separately (Installed)
8	C/W R5 Insulation (Installed by EXM)

No.	Revisions	Date	By/Par

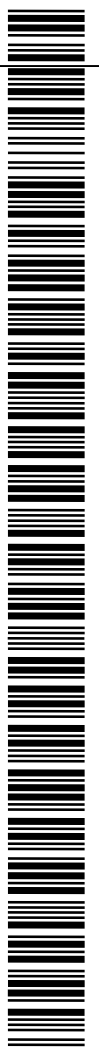
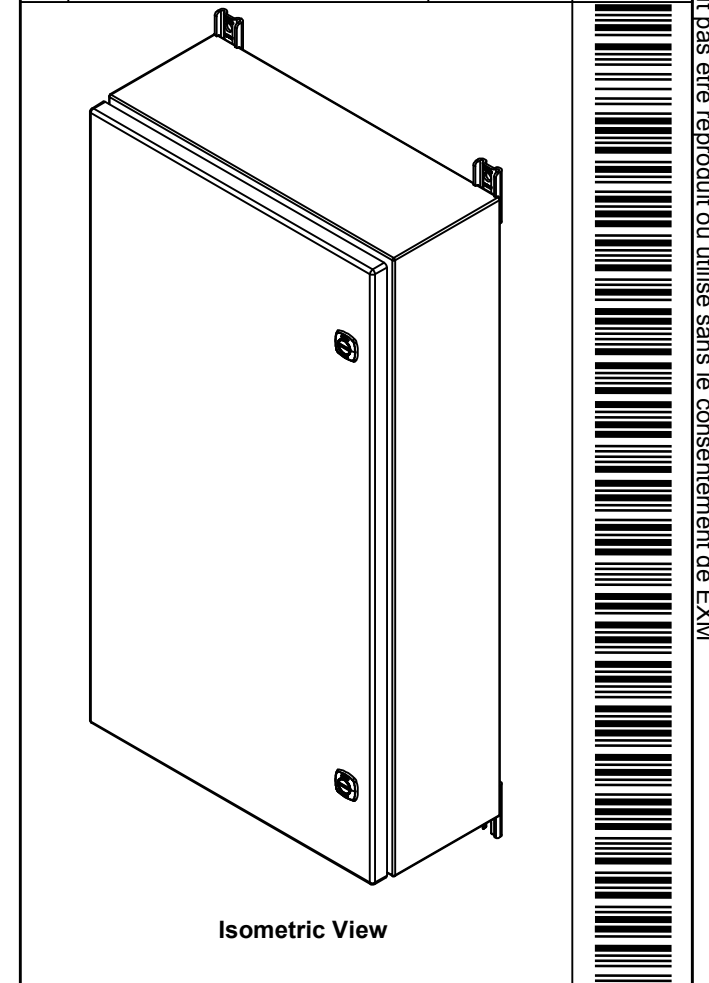

 Tél: (450) 979-4373
 Fax: (450) 979-4626
www.exmweb.com

Flatness / Aplatissement: Max 3.0mm
 Projection: 

Customer Client	Date
Drawn By / Dessiné Par: BoxCad: BoxCad	Date: 30-May-23

Material / Matière: 16 Ga Stainless Steel 316 (1.4mm)

Color / Couleur: Unpainted Finish / Fini: Brushed

Description: 5412ESS 30" x 16" x 6" Assembly Detail Rev.

Part Number / Numéro Pièce: **5412ESS3016066THNOIP** Rev. **0** 2/16

Qty	Part Number	Rev	Description
4	STK-Q-00600	2	M12 to M8 Adaptor
1	STK-K-01800	5	5412 ES Accessory Kit
1	5412ESS3016066THNOIP C	0	5412ESS 30" x 16" Cover
1	5412ESS3016066THNOIP B	0	5412ESS 30" x 16" x 6" Body
2	STK-Q-04051-08	1	M6 x 8mm Stainless Steel Hexagon Socket Head Machine Screw with Nyseal
Parts List			

PACKING		
ITEM	QTY	DESCRIPTION
Cardboard sleeve	2	Top and Bottom
Cardboard strip	2	Between back of enclosure and inner panel
Plastic bag	1	To protect cover surface and inside gasket
Plastic strap - Black	2	To Squeeze the 2 cardboard sleeve together
Packaging label	1	White label with product number

This drawing is confidential and must not be reproduced or used without the consent of EXM

Ce dessin est confidentiel et ne doit pas être reproduit ou utilisé sans le consentement de EXM

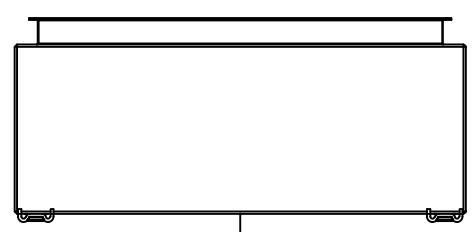

TOP

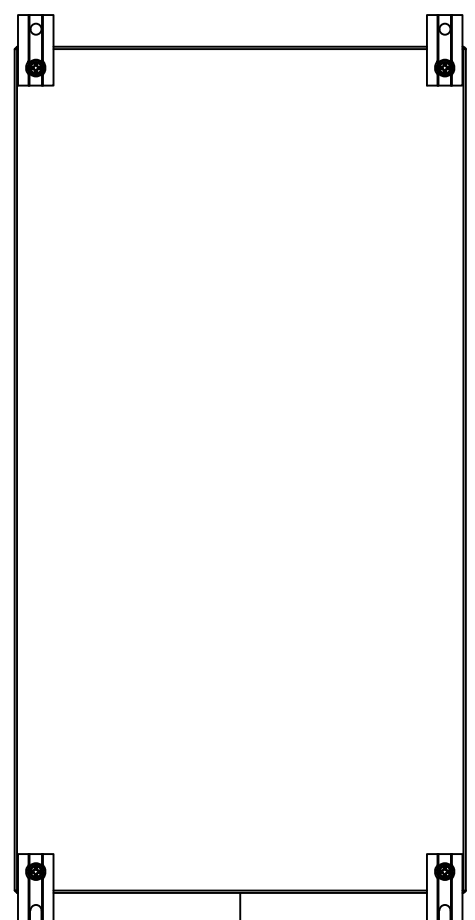

BACK

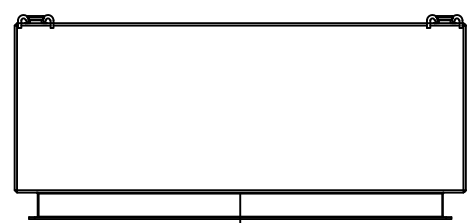

BOTTOM

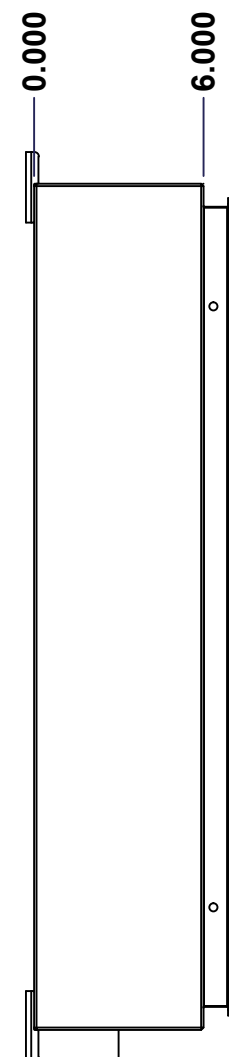

LEFT

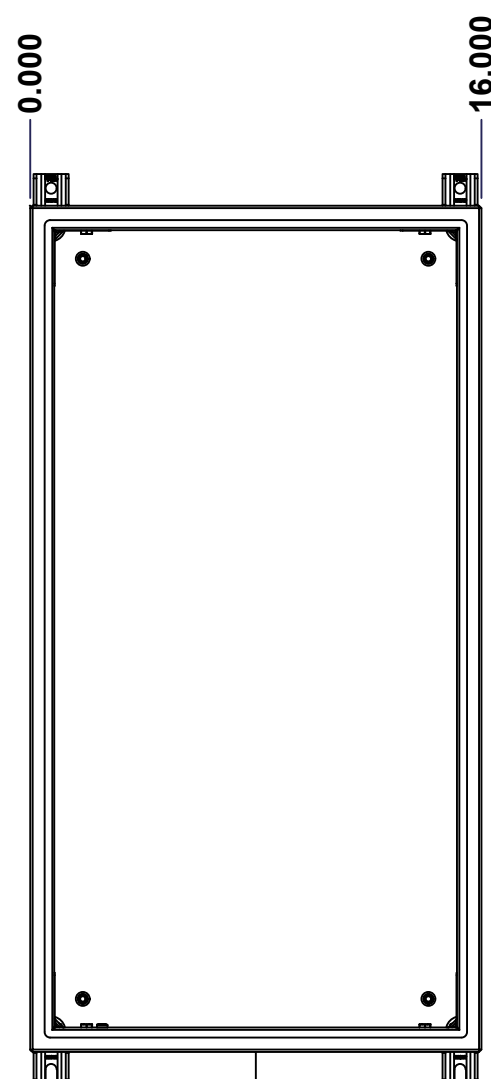

FRONT

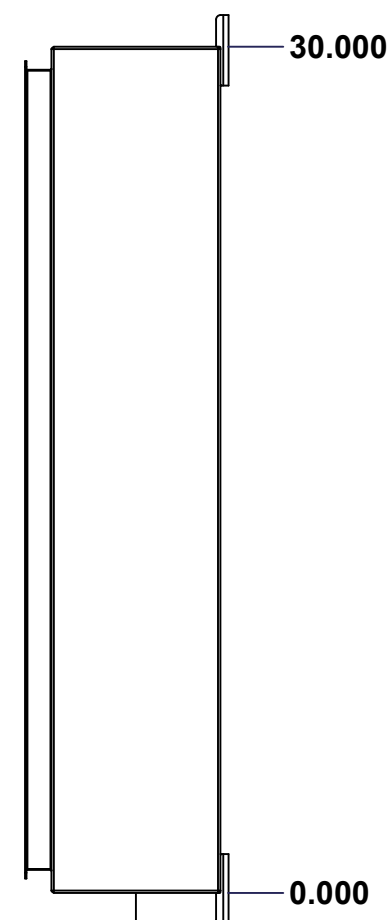

RIGHT

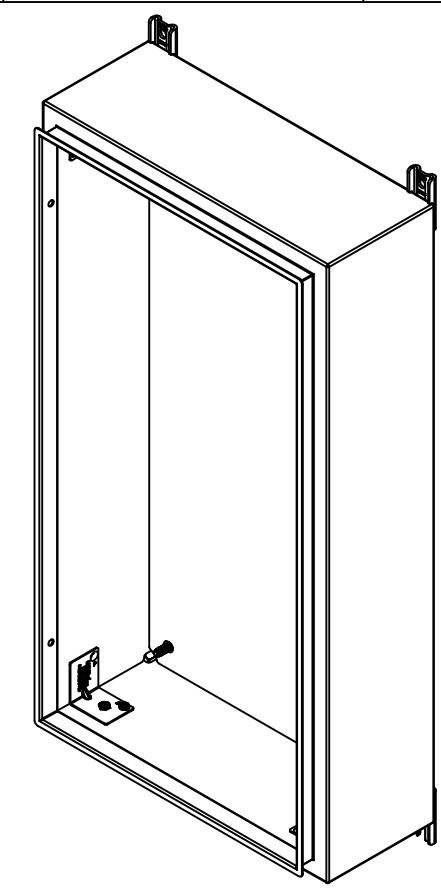

Isometric View

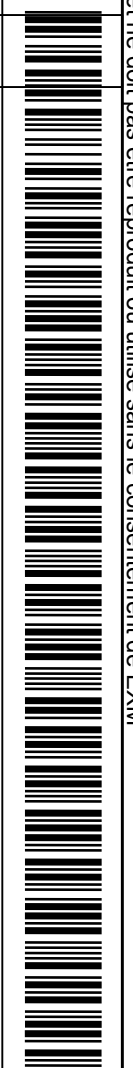

No.	Revisions	Date	By/Par

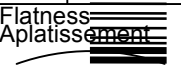
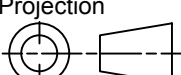
 Tél: (450) 979-4373 Fax: (450) 979-4626 www.exmweb.com		Flatness Aplatissement  Max 3.0mm Projection 
Customer Client	Date	
Drawn By Dessiné Par	BoxCad: BoxCad	Date 30-May-23
Material Matière	16 Ga Stainless Steel 316 (1.4mm)	
Color Couleur	Unpainted	Finish Fini Brushed
Description	Detail Rev.	
5412ESS 30" x 16" x 6" Body		
Part Number Numéro Pièce	Rev.	3
SEE BILL OF MATERIAL ON LAST PAGE 5412ESS3016066THNOIPB	0	16

SEE BILL OF MATERIAL ON LAST PAGE 5412ESS3016066THNOIPB

This drawing is confidential and must not be reproduced or used without the consent of EXM

Ce dessin est confidentiel et ne doit pas être reproduit ou utilisé sans le consentement de EXM

STANDARD FEATURES ARE NOT LISTED IN THIS HOLE TABLE			
HOLE TABLE - TOP VIEW (CUSTOM FEATURE ONLY)			
CUT-OUT	XDIM	YDIM	DESCRIPTION
1	2.000	4.500	INSUL. STUD M6 x 18mm (Inside)
2	14.000	4.500	INSUL. STUD M6 x 18mm (Inside)

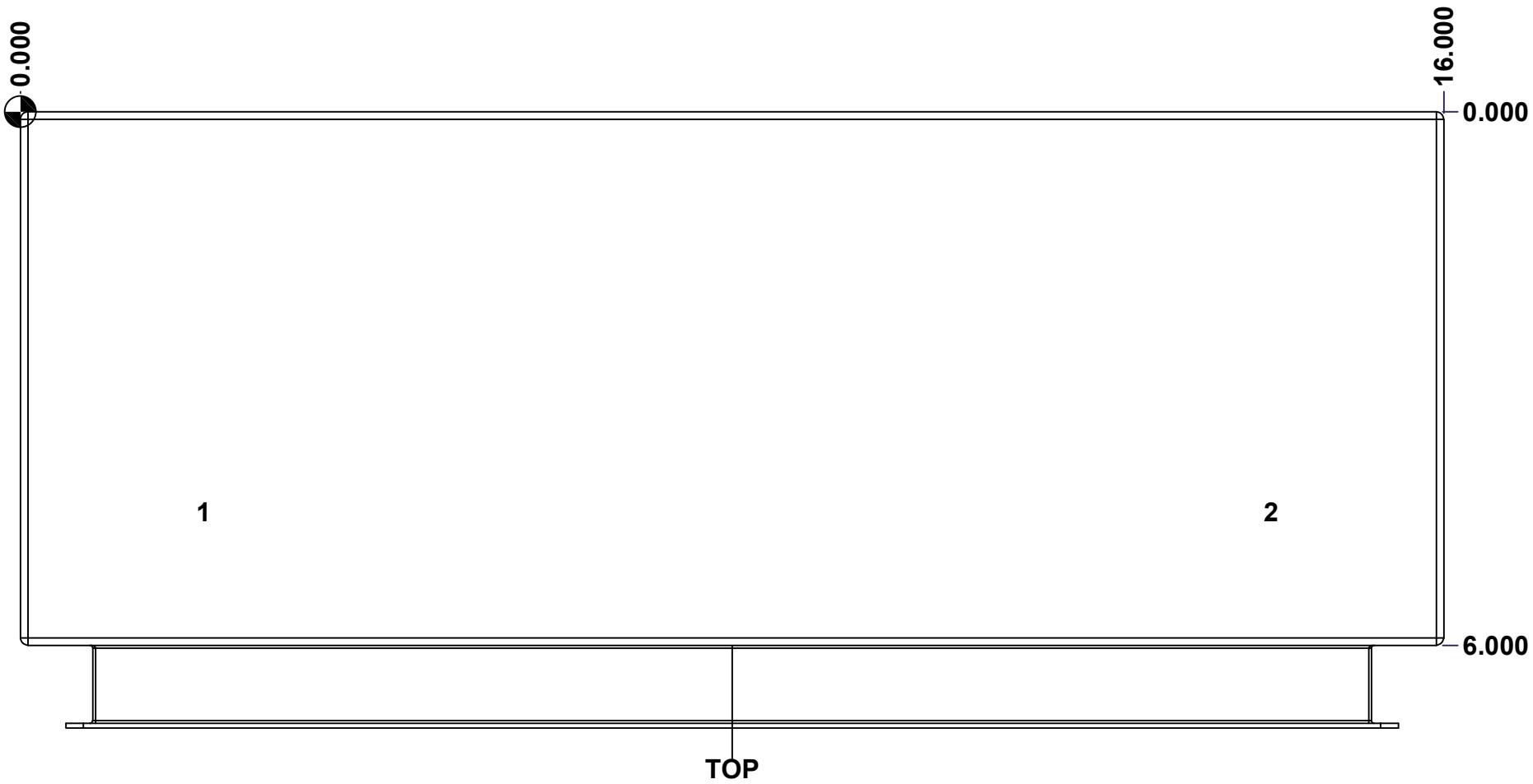

	Description	Status
	5412ESS 30" x 16" x 6" Body	(NULL)
	Part Number	Rev.
	5412ESS3016066THNOIPB	4
		16

This drawing is confidential and must not be reproduced or used without the consent of EXM

Ce dessin est confidentiel et ne doit pas être reproduit ou utilisé sans le consentement de EXM

STANDARD FEATURES ARE NOT LISTED IN THIS HOLE TABLE			
HOLE TABLE - BOTTOM VIEW (CUSTOM FEATURE ONLY)			
CUT-OUT	XDIM	YDIM	DESCRIPTION
1	2.000	4.500	INSUL. STUD M6 x 18mm (Inside)
2	14.000	4.500	INSUL. STUD M6 x 18mm (Inside)

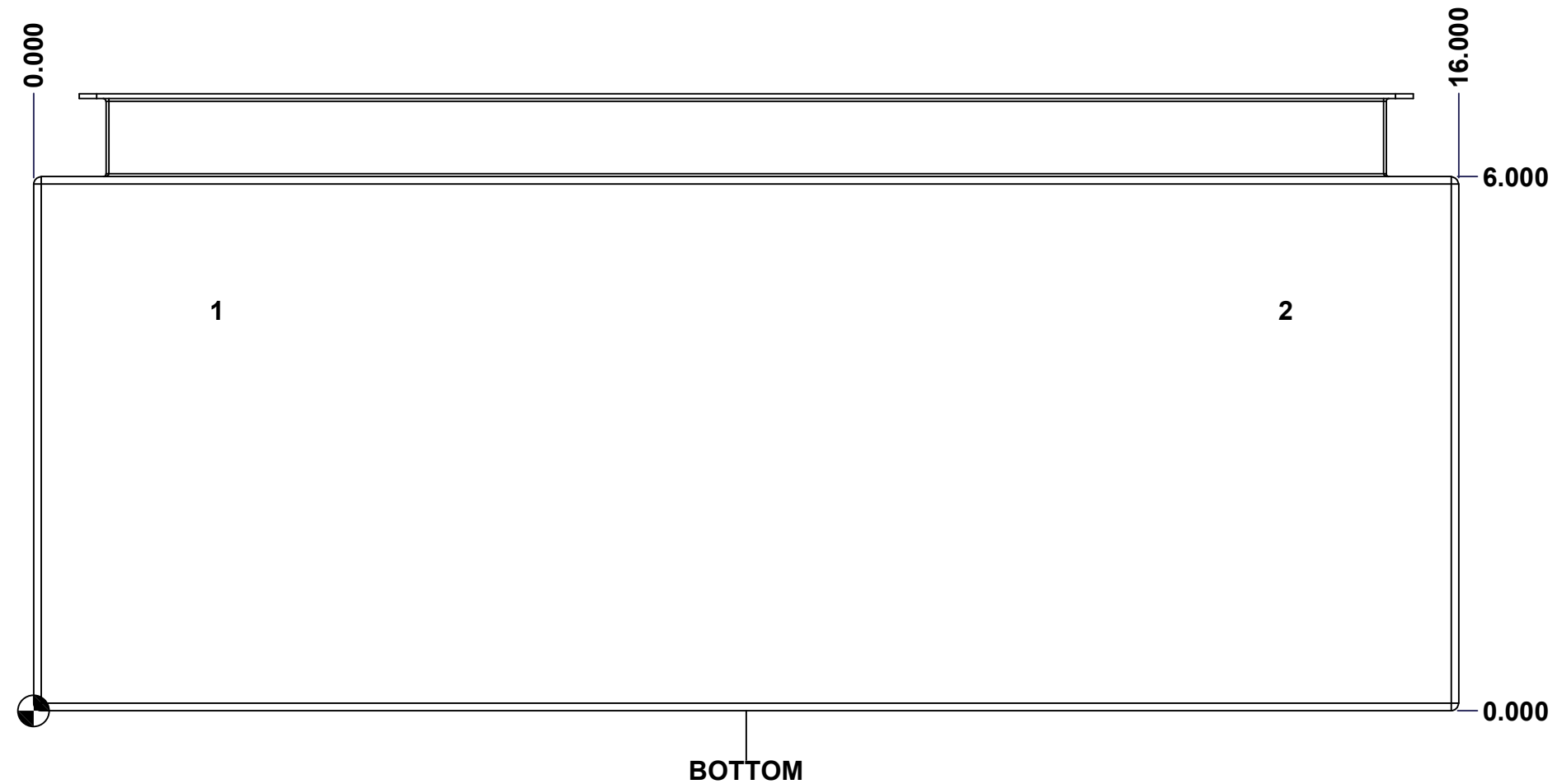

	Description	Status
	5412ESS 30" x 16" x 6" Body	(NULL)
	Part Number Numéro Pièce	Rev.
	5412ESS3016066THNOIPB	0
		5
		16

This drawing is confidential and must not be reproduced or used without the consent of EXM

Ce dessin est confidentiel et ne doit pas être reproduit ou utilisé sans le consentement de EXM

STANDARD FEATURES ARE NOT LISTED IN THIS HOLE TABLE

HOLE TABLE - BACK VIEW (CUSTOM FEATURE ONLY)

CUT-OUT	XDIM	YDIM	DESCRIPTION
1	1.875	1.875	IP STUD M8 x 35mm (Inside)
2	1.875	28.125	IP STUD M8 x 35mm (Inside)
3	14.125	28.125	IP STUD M8 x 35mm (Inside)
4	14.125	1.875	IP STUD M8 x 35mm (Inside)

5	15.250	0.000	FOOT 885 ESMF4_OPEN
6	0.750	0.000	FOOT 885 ESMF4_OPEN
7	15.250	30.000	FOOT 885 ESMF4_CLOSE
8	0.750	30.000	FOOT 885 ESMF4_CLOSE

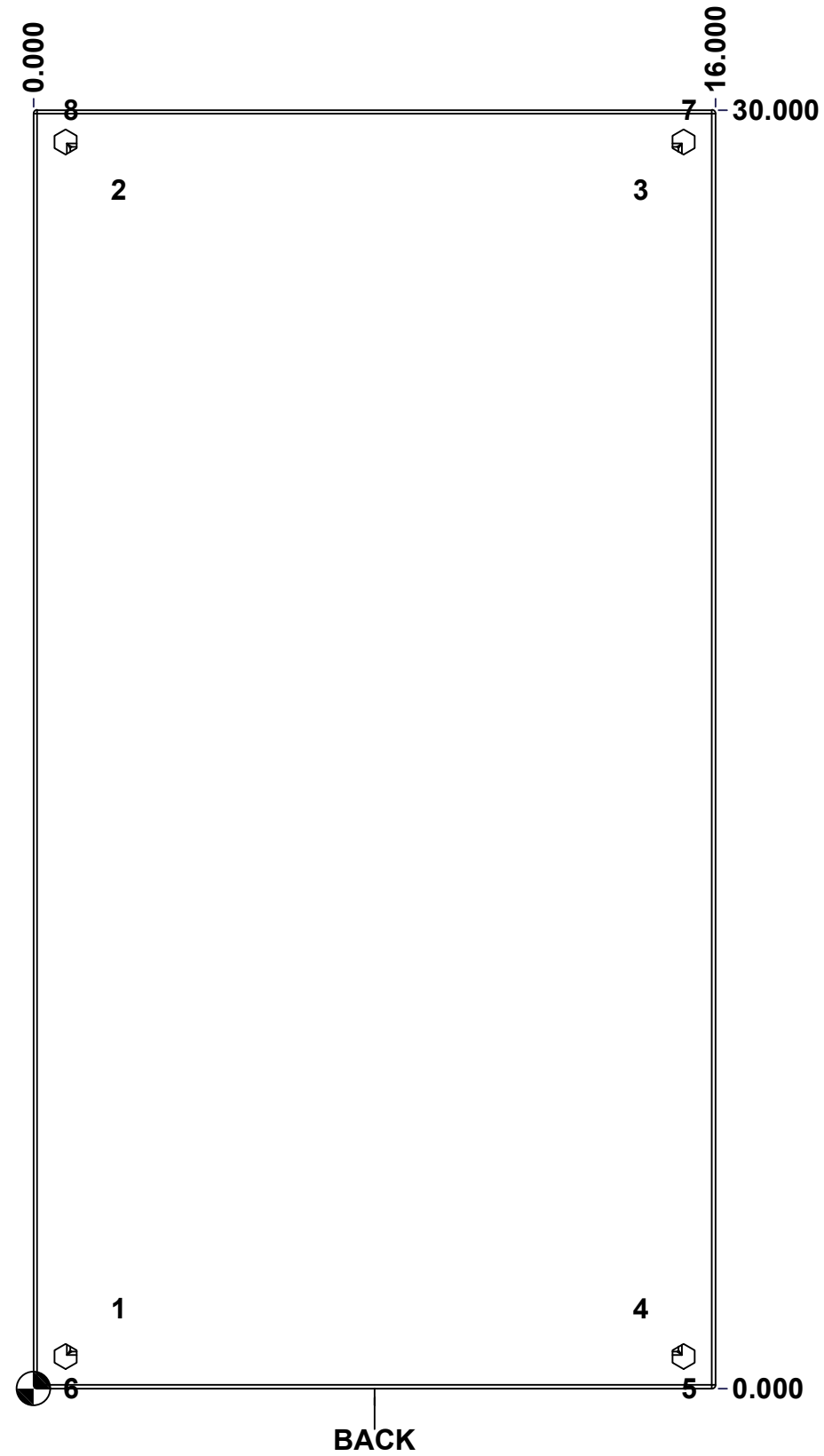

	Description	Status
	5412ESS 30" x 16" x 6" Body	(NULL)
	Part Number Numéro Pièce	Rev.
	5412ESS3016066THNOIPB	0 / 6
		16

This drawing is confidential and must not be reproduced or used without the consent of EXM

Ce dessin est confidentiel et ne doit pas être reproduit ou utilisé sans le consentement de EXM

No.	Revisions	Date	By/Par

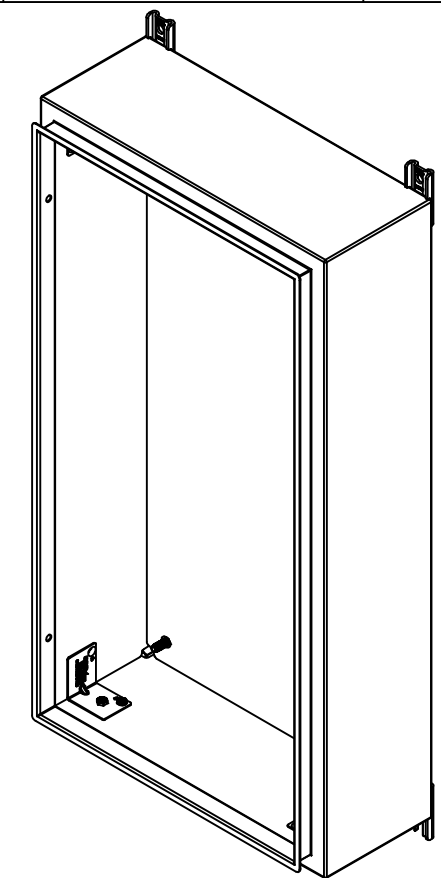

Isometric View



2	885ESMF4-FEET	0	885 ESMF4 Stainless Steel Mounting Foot
4	RIVET_NUT_SS_M10_FH_CE	0	Stainless Steel Rivet Nut M10 (Low Profile Close End)
4	STK-Q-06670	2	M10 x 16mm Stainless Steel Machine Screw
2	885ESMF4-FEET-A	0	885 ESMF4 Stainless Steel Mounting Foot (Opened Slot)
1	STK-K-70554	3	5412 ESTH Accessory Kit
1	5412ESS3016066THNOIP I-RS	0	5412ESS 30" x 16" Right Insulation
1	5412ESS3016066THNOIP I-LS	0	5412ESS 30" x 16" Left Insulation
1	5412ESS3016066THNOIP I-BT	0	5412ESS 30" x 16" Top and Bottom Insulation
1	5412ESS3016066THNOIP I-TP	0	5412ESS 30" x 16" Top and Bottom Insulation
1	5412ESS3016066THNOIP I-B	0	5412ESS 30" x 16" Back Insulation
4	STK-Q-16070	1	Stud M6 x 18mm Stainless steel
4	STK-Q-16020	1	Stud M8 x 35mm Stainless Steel
1	5412ESS3016066THNOIP B-P	0	5412ESS 30" x 16" x 6" Body Part

Qty	Part Number	Rev	Description
Parts List			



Tél: (450) 979-4373
Fax: (450) 979-4626
www.exmweb.com

Flatness
Aplatissement
Max 3.0mm

Projection

Customer Client	Date
Drawn By / Dessiné Par: BoxCad: BoxCad	Date: 30-May-23
Material / Matière: 16 Ga Stainless Steel 316 (1.4mm)	
Color / Couleur: Unpainted	Finish / Fini: Brushed
Description: 5412ESS 30" x 16" x 6" Body	
Part Number / Numéro Pièce: 5412ESS3016066THNOIPB	Rev. 0

This drawing is confidential and must not be reproduced or used without the consent of EXM

Ce dessin est confidentiel et ne doit pas être reproduit ou utilisé sans le consentement de EXM

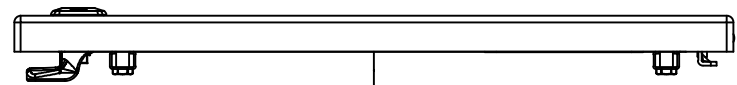

TOP

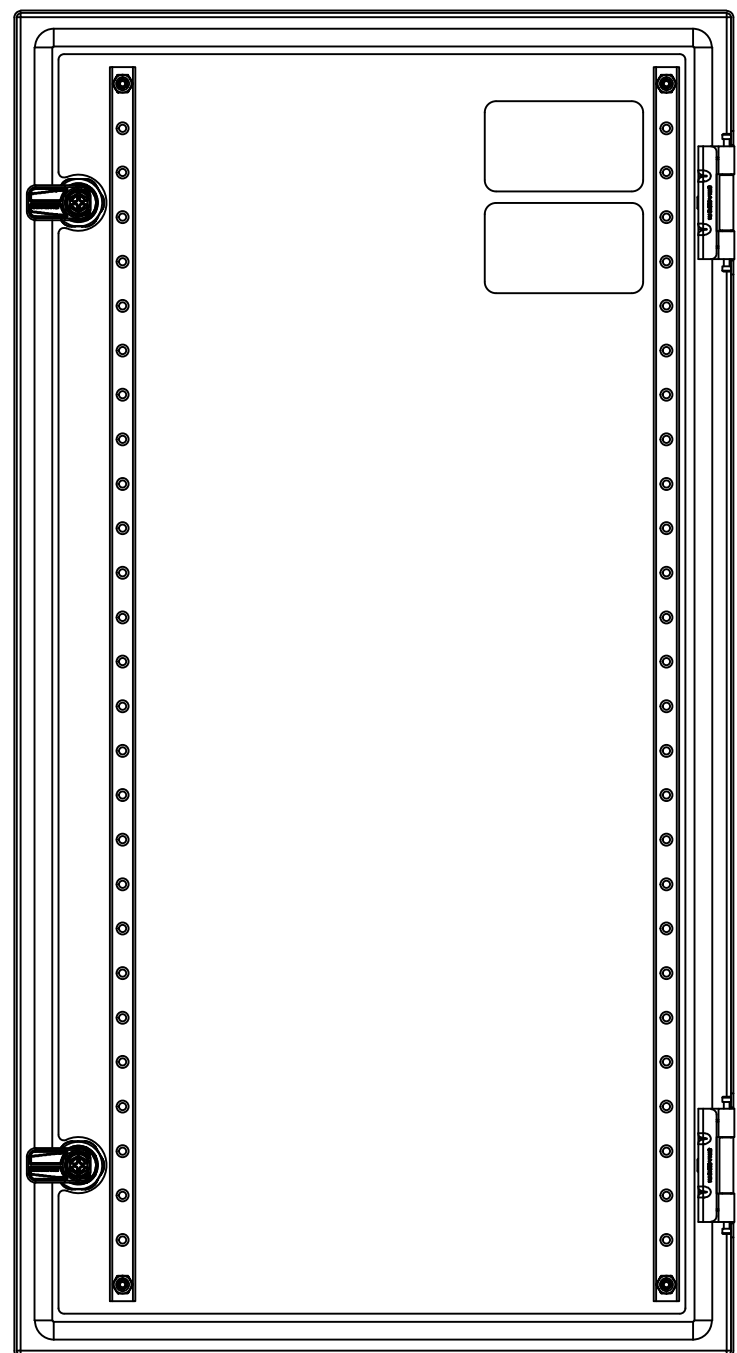

BACK

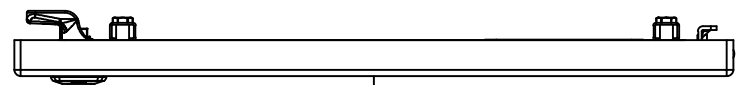

BOTTOM

0.000
0.800

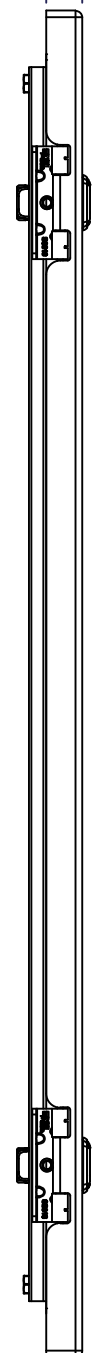

LEFT

0.000

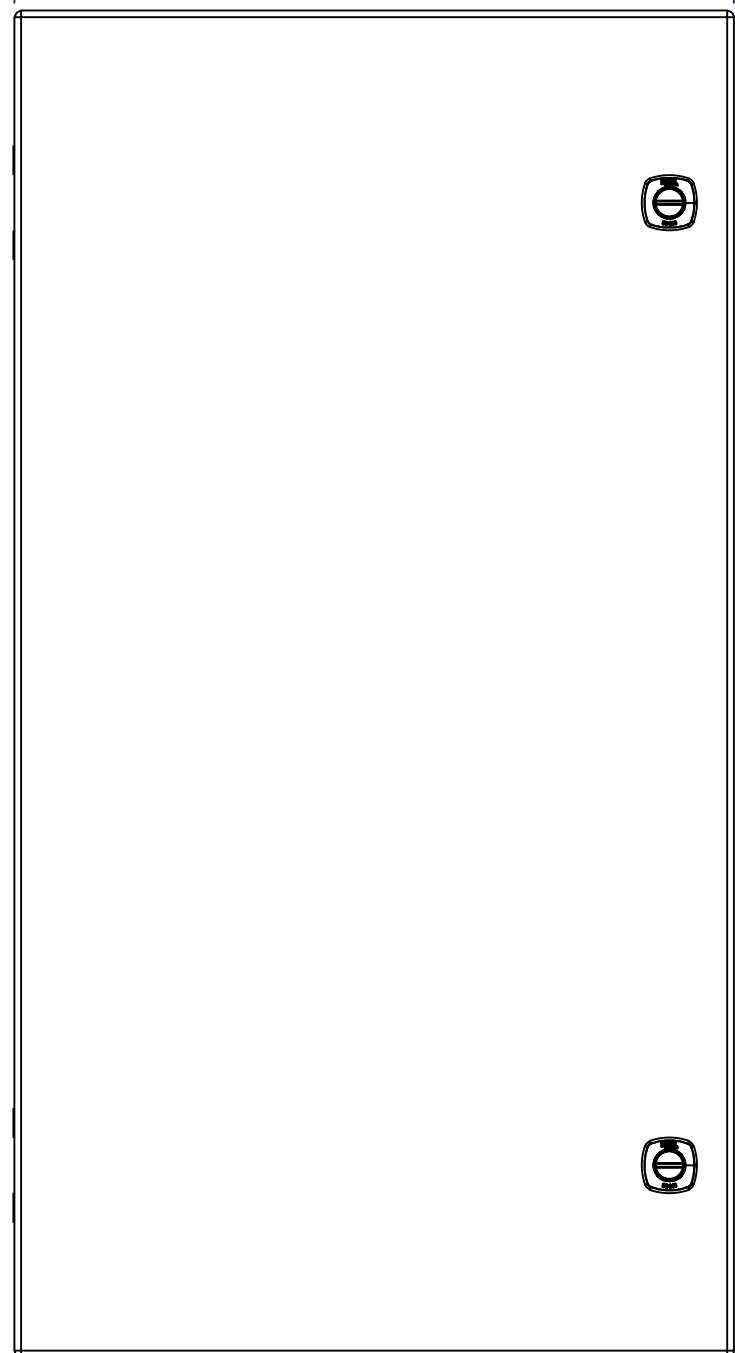

FRONT

15.918

29.803

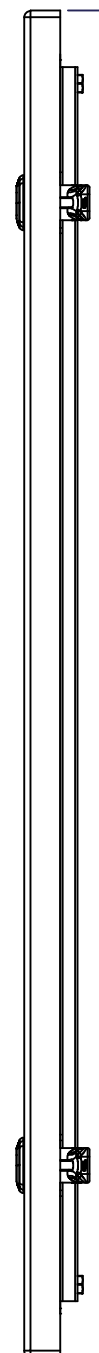

RIGHT

0.000

No.	Revisions	Date	By/Par

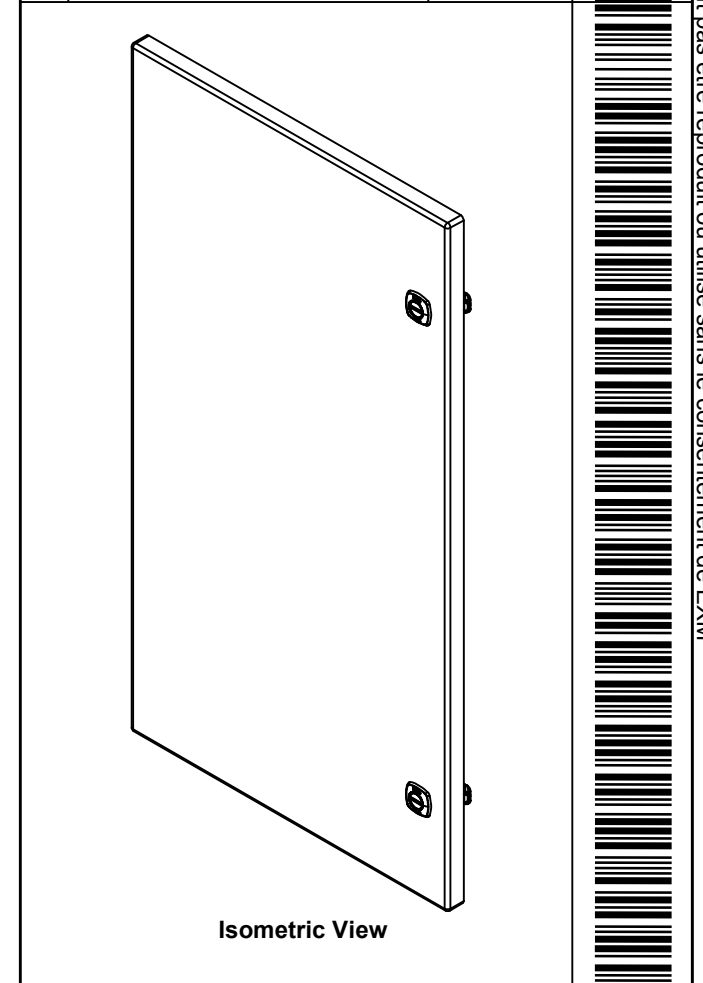

Isometric View



Tél: (450) 979-4373
Fax: (450) 979-4626
www.exmweb.com

Flatness
Aplatissement
Max 3.0mm
Projection

Customer Client	Date
Drawn By Dessiné Par BoxCad: BoxCad	Date 30-May-23
Material Matière 16 Ga Stainless Steel 316 (1.4mm)	
Color Couleur Unpainted	Finish Fini Brushed
Description 5412ESS 30" x 16" Cover	Detail Rev.
Part Number Numéro Pièce	Rev. 8
SEE BILL OF MATERIAL ON LAST PAGE 5412ESS3016066THNOIPC	
	0

This drawing is confidential and must not be reproduced or used without the consent of EXM

Ce dessin est confidentiel et ne doit pas être reproduit ou utilisé sans le consentement de EXM

STANDARD FEATURES ARE NOT LISTED IN THIS HOLE TABLE			
HOLE TABLE - FRONT VIEW (CUSTOM FEATURE ONLY)			
CUT-OUT	XDIM	YDIM	DESCRIPTION
1	1.486	1.614	STUD M6 x 18mm (Inside)
2	1.486	28.189	STUD M6 x 18mm (Inside)
3	13.517	28.189	STUD M6 x 18mm (Inside)
4	13.517	1.614	STUD M6 x 18mm (Inside)

5	14.494	25.553	880 SCQ4-SLSS6
6	14.494	4.250	880 SCQ4-SLSS6

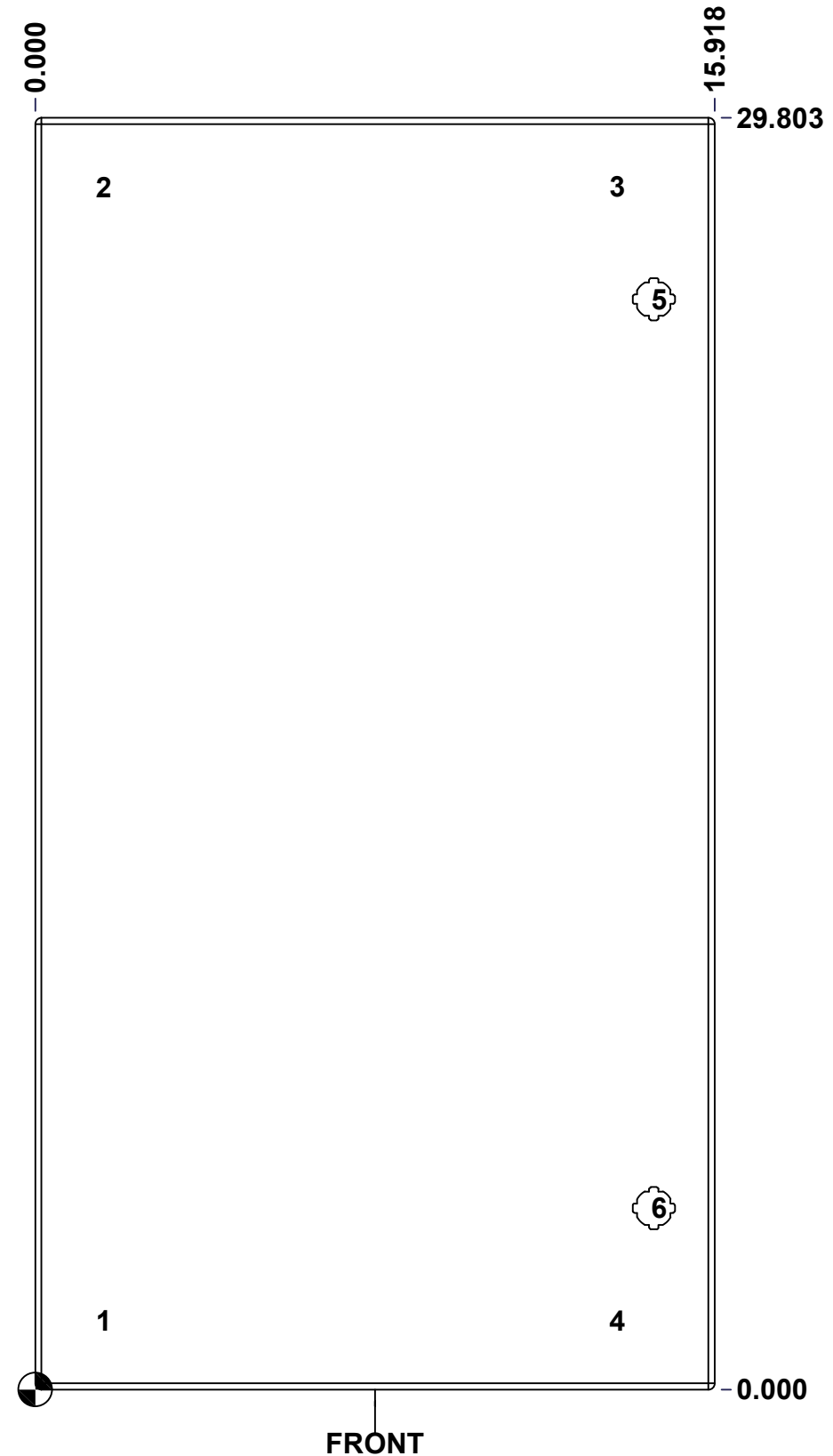

FRONT

	Description	Status
	5412ESS 30" x 16" Cover	(NULL)
	Part Number Numéro Pièce	Rev.
	5412ESS3016066THNOIPC	0
		9
		16

This drawing is confidential and must not be reproduced or used without the consent of EXM

Ce dessin est confidentiel et ne doit pas être reproduit ou utilisé sans le consentement de EXM

No.	Revisions	Date	By/Par

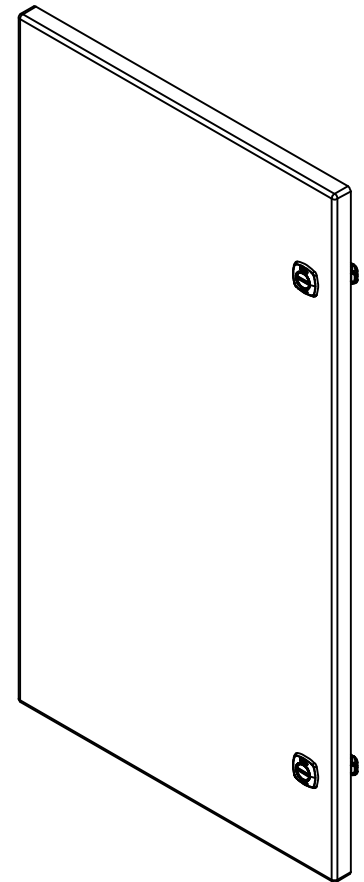

Isometric View

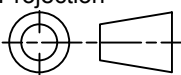

QTY	Part Number	Rev	Description
2	STK-S-00100	0	3.5" x 2" Silver Milar Flexcon Sticker
4	STK-Q-07250	2	M6 x 16mm Collar Nut
2	STK-Q-46020-30	5	5412 ES Vertical Door Stiffener 30"
1	5412ESS3016066THNOIP I-C	0	5412ESS 30" x 16" Cover Insulation
4	STK-Q-16070	1	Stud M6 x 18mm Stainless steel
1	5412ESS3016066THNOIP G	0	5412ESS 30" x 16" Cover Gasket Part
1	5412ESS3016066THNOIP C-P	0	5412ESS 30" x 16" Cover Part
2	880 SCQ4-SLSS6	7	5412 ESS 1/4 Turn Lock
2	STK-A-33016	0	5412 ESS Bended Hinge (Body Part)
Parts List			

 Tél: (450) 979-4373 Fax: (450) 979-4626 www.exmweb.com		Flatness Aplatissement Max 3.0mm Projection 
Customer Client	Date	
Drawn By Dessiné Par	BoxCad: BoxCad	Date 30-May-23
Material Matière	16 Ga Stainless Steel 316 (1.4mm)	
Color Couleur	Unpainted	Finish Fini Brushed
Description		Detail Rev.
5412ESS 30" x 16" Cover		
Part Number Numéro Pièce	Rev.	10
5412ESS3016066THNOIPC	0	16

This drawing is confidential and must not be reproduced or used without the consent of EXM

Ce dessin est confidentiel et ne doit pas être reproduit ou utilisé sans le consentement de EXM

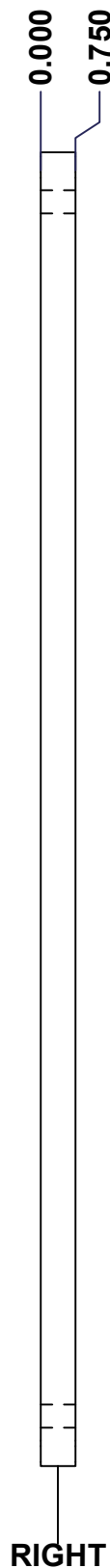
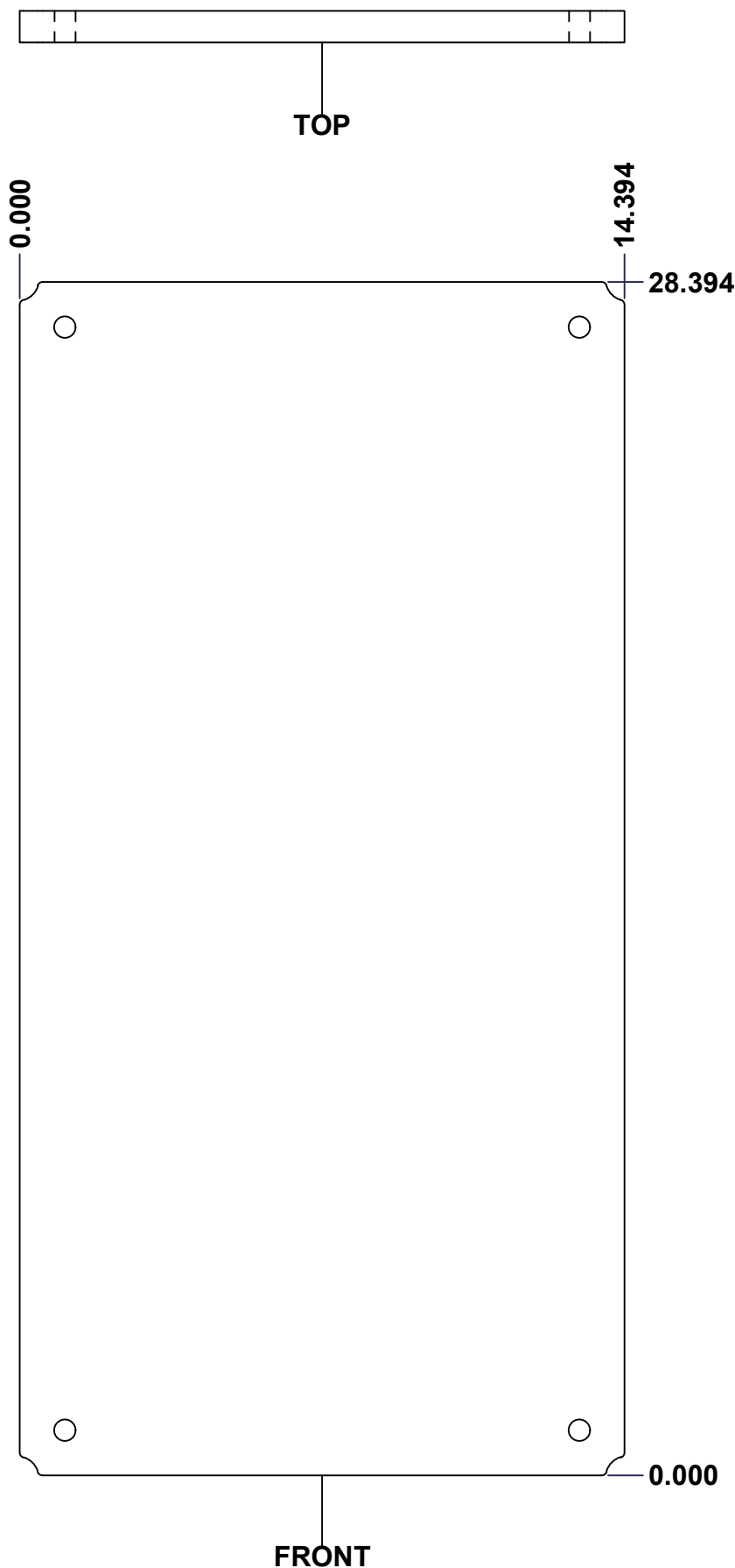

No.	Revisions	Date	By/Par

Isometric View

<p>Tél: (450) 979-4373 Fax: (450) 979-4626 www.exmweb.com</p>		Flatness Aplatissement
		Max 3.0mm
Projection		
Customer Client	Date	
Drawn By Dessiné Par	BoxCad: Patrick Deschenes	Date 23-Jan-07
Material Matière Polyisocyanurate		
Color Couleur	Aluminum	Finish Fini N/A
Description		Detail Rev.
5412ESS 30" x 16" Back Insulation		
Part Number Numéro Pièce	Rev.	11
SEE BILL OF MATERIAL ON LAST PAGE 5412ESS3016066THNOIP-B		0

This drawing is confidential and must not be reproduced or used without the consent of EXM

Ce dessin est confidentiel et ne doit pas être reproduit ou utilisé sans le consentement de EXM

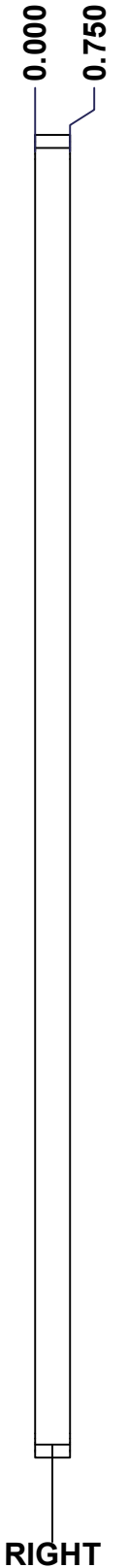

No.	Revisions	Date	By/Par

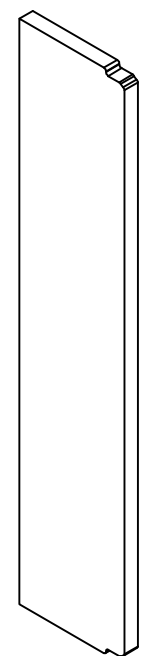

Isometric View

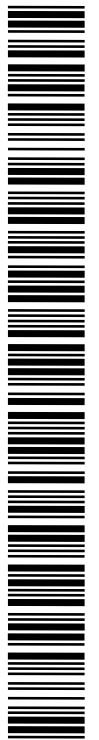

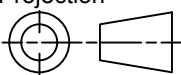
 Tél: (450) 979-4373 Fax: (450) 979-4626 www.exmweb.com		Flatness Aplatissement Max 3.0mm Projection 	
Customer Client		Date	
Drawn By Dessiné Par BoxCad: Patrick Deschenes		Date 23-Jan-07	
Material Matière Polyisocyanurate			
Color Couleur Aluminum		Finish Fini N/A	
Description 5412ESS 30" x 16" Left Insulation			Detail Rev.
Part Number Numéro Pièce 5412ESS3016066THNOIPI-LS		Rev.	12
SEE BILL OF MATERIAL ON LAST PAGE		0	16

This drawing is confidential and must not be reproduced or used without the consent of EXM

Ce dessin est confidentiel et ne doit pas être reproduit ou utilisé sans le consentement de EXM

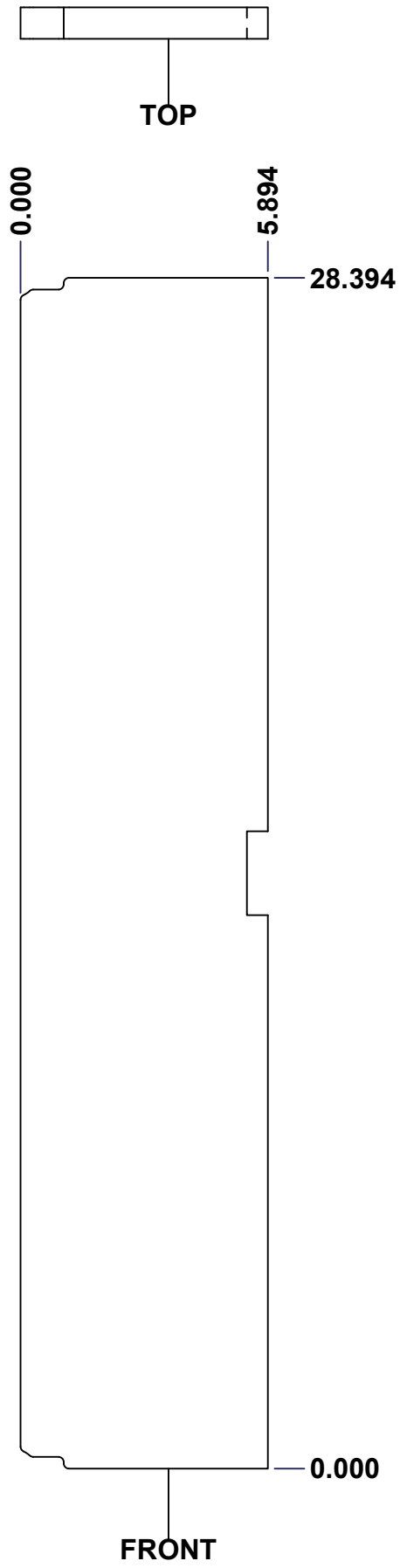

No.	Revisions	Date	By/Par

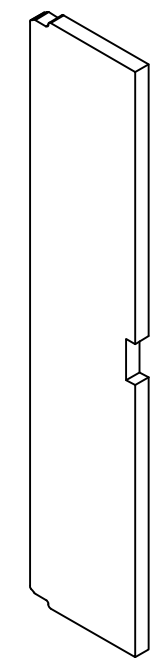

Isometric View

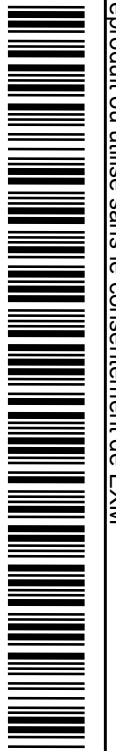

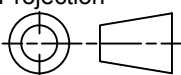
 Tél: (450) 979-4373 Fax: (450) 979-4626 www.exmweb.com		Flatness Aplatissement Max 3.0mm
Projection 		Date 23-Jan-07
Customer Client	Date	
Drawn By Dessiné Par	BoxCad: Patrick Deschenes	Date 23-Jan-07
Material Matière	Polyisocyanurate	
Color Couleur	Aluminum	Finish Fini N/A
Description	Detail Rev.	
5412ESS 30" x 16" Right Insulation		
Part Number Numéro Pièce	Rev.	13
5412ESS3016066THNOIPI-RS	0	16

SEE BILL OF MATERIAL ON LAST PAGE

This drawing is confidential and must not be reproduced or used without the consent of EXM

Ce dessin est confidentiel et ne doit pas être reproduit ou utilisé sans le consentement de EXM



TOP

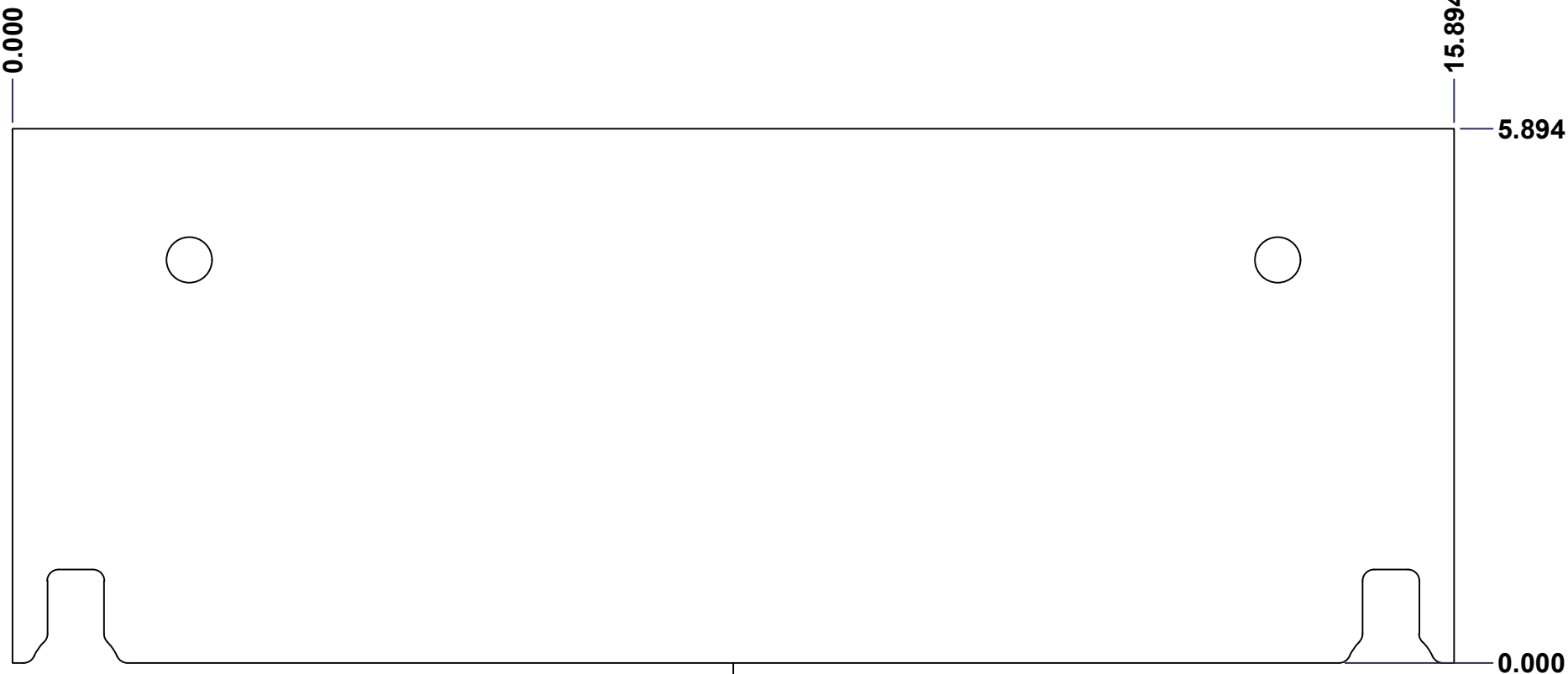

FRONT

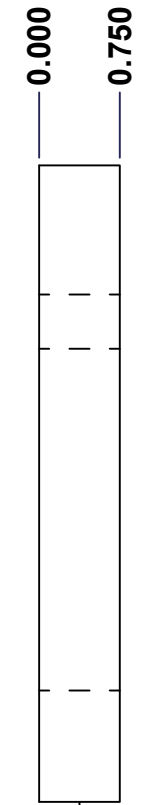

RIGHT

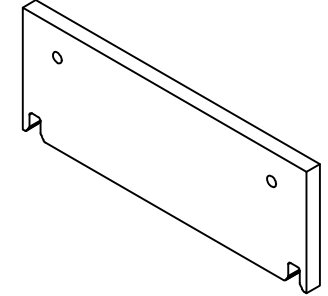

Isometric View

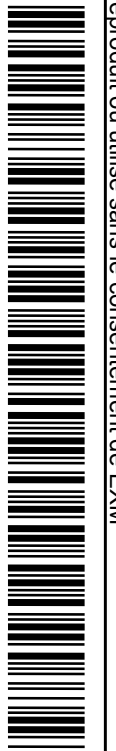

Tél: (450) 979-4373
 Fax: (450) 979-4626
www.exmweb.com

Flatness
 Aplatissement
 Max 3.0mm
 Projection

Customer Client	Date
Drawn By Dessiné Par BoxCad: Patrick Deschenes	Date 23-Jan-07
Material Matière Polyisocyanurate	
Color Couleur Aluminum	Finish Fini N/A
Description 5412ESS 30" x 16" Top and Bottom Insulation	Detail Rev.
Part Number Numéro Pièce	Rev. 14

SEE BILL OF MATERIAL ON LAST PAGE 5412ESS3016066THNOIPI-TP 0

This drawing is confidential and must not be reproduced or used without the consent of EXM

Ce dessin est confidentiel et ne doit pas être reproduit ou utilisé sans le consentement de EXM



TOP

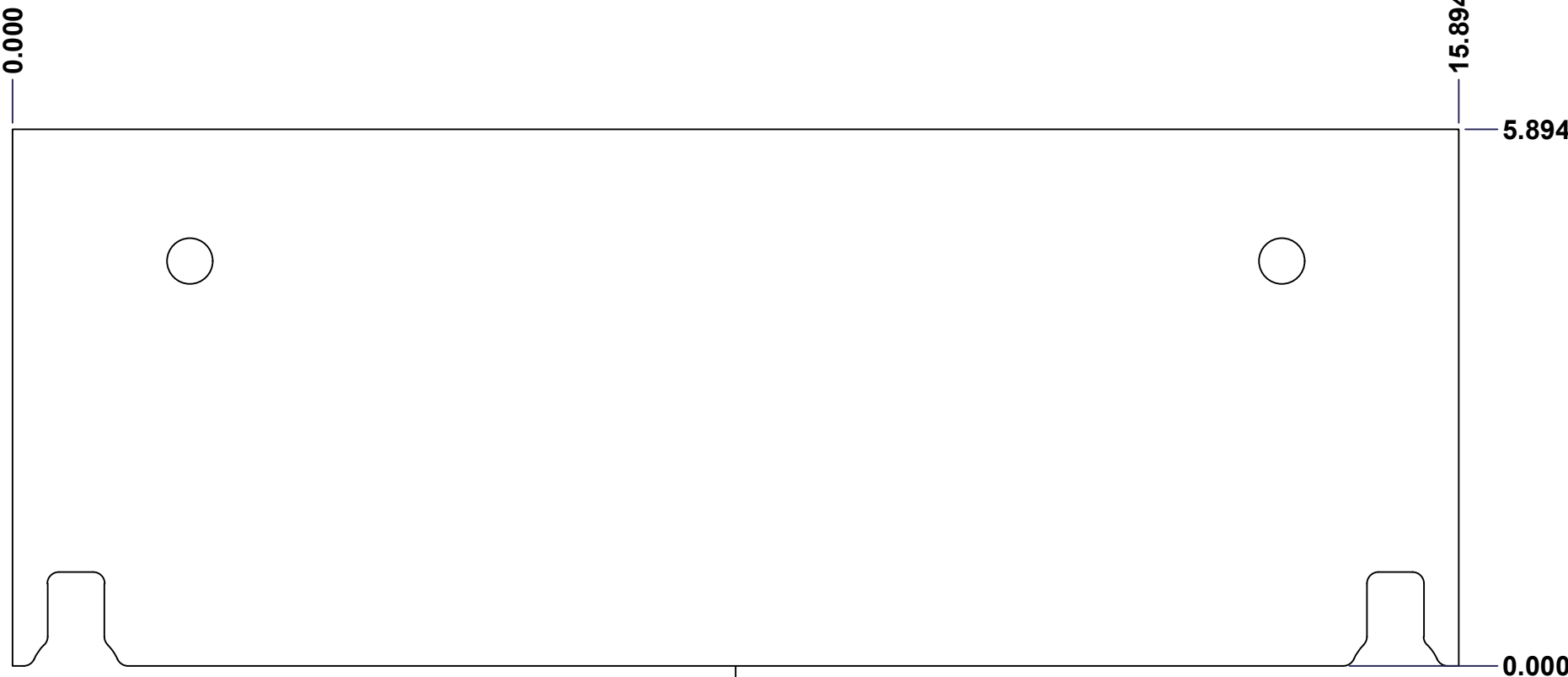

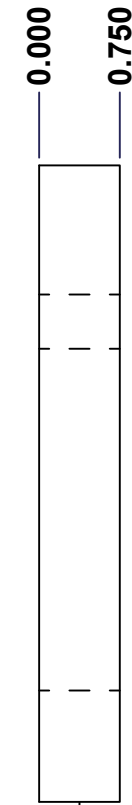

FRONT

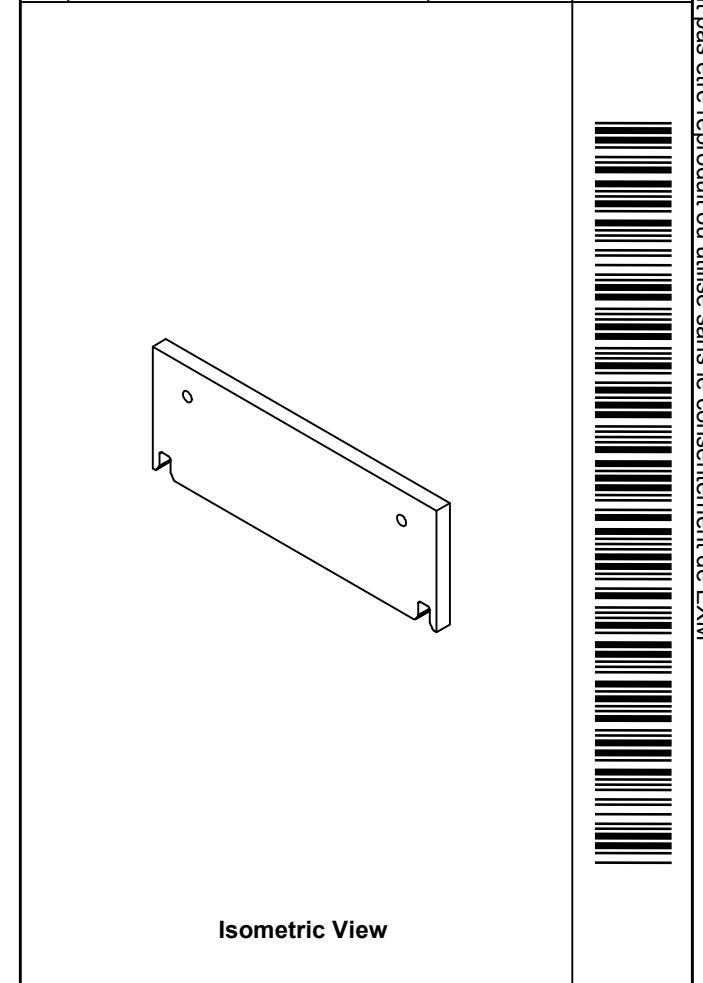

RIGHT

No.	Revisions	Date	By/Par



 Tél: (450) 979-4373 Fax: (450) 979-4626 www.exmweb.com		Flatness Aplatissement
		Max 3.0mm
Customer Client		Date
Drawn By / Dessiné Par: BoxCad: Patrick Deschenes		Date: 23-Jan-07
Material / Matière: Polyisocyanurate		
Color / Couleur: Aluminum	Finish / Fini: N/A	
Description: 5412ESS 30" x 16" Top and Bottom Insulation		Detail Rev.
Part Number / Numéro Pièce: 5412ESS3016066THNOIPI-BT		Rev. 15

SEE BILL OF MATERIAL ON LAST PAGE 5412ESS3016066THNOIPI-BT 0 16

This drawing is confidential and must not be reproduced or used without the consent of EXM

Ce dessin est confidentiel et ne doit pas être reproduit ou utilisé sans le consentement de EXM

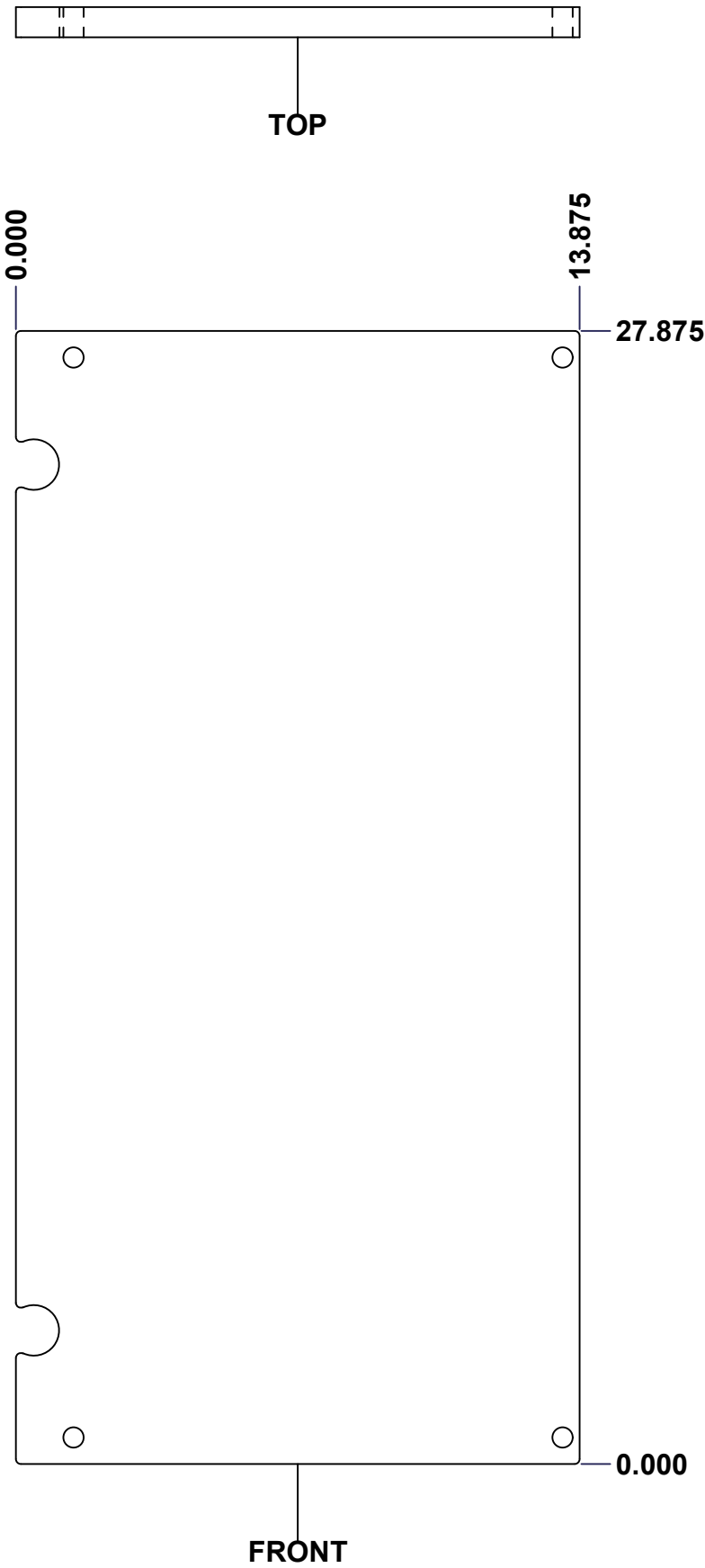

No.	Revisions	Date	By/Par

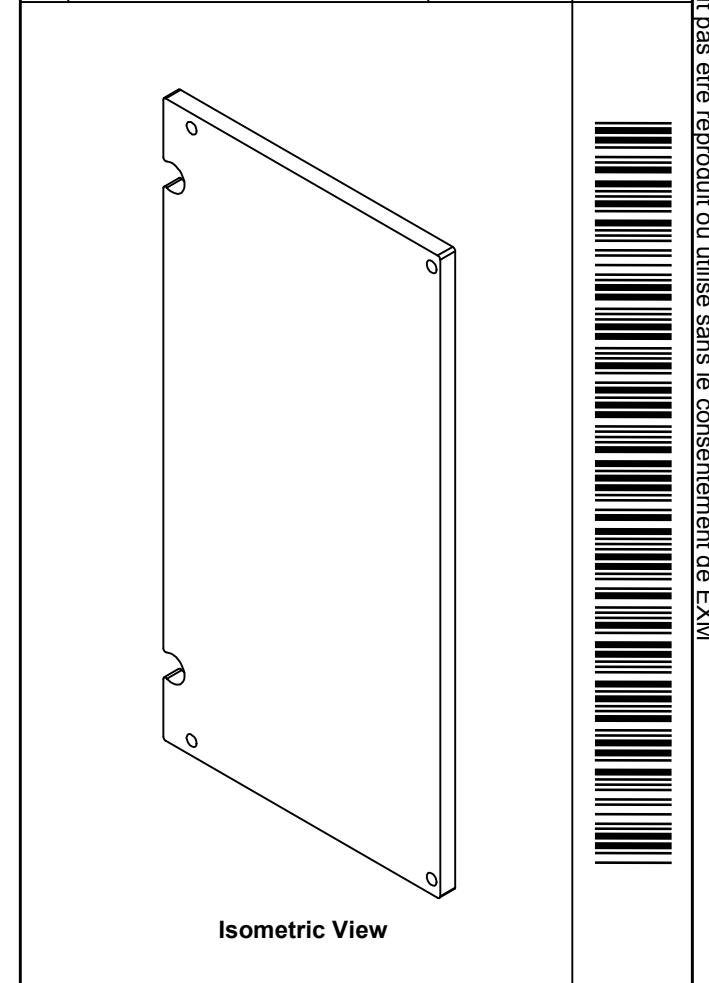

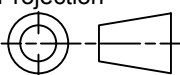
 Tél: (450) 979-4373 Fax: (450) 979-4626 www.exmweb.com		Flatness Aplatissement Max 3.0mm Projection 
Customer Client	Date	
Drawn By Dessiné Par	BoxCad: Patrick Deschenes	Date 23-Jan-07
Material Matière	Polyisocyanurate	
Color Couleur	Aluminum	Finish Fini N/A
Description	Detail Rev.	
5412ESS 30" x 16" Cover Insulation		
Part Number Numéro Pièce	Rev. 0	16

SEE BILL OF MATERIAL ON LAST PAGE 5412ESS3016066THNOIP-C 0 16