

This drawing is confidential and must not be reproduced or used without the consent of EXM

Ce dessin est confidentiel et ne doit pas être reproduit ou utilisé sans le consentement de EXM

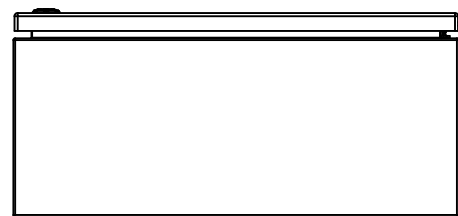

TOP

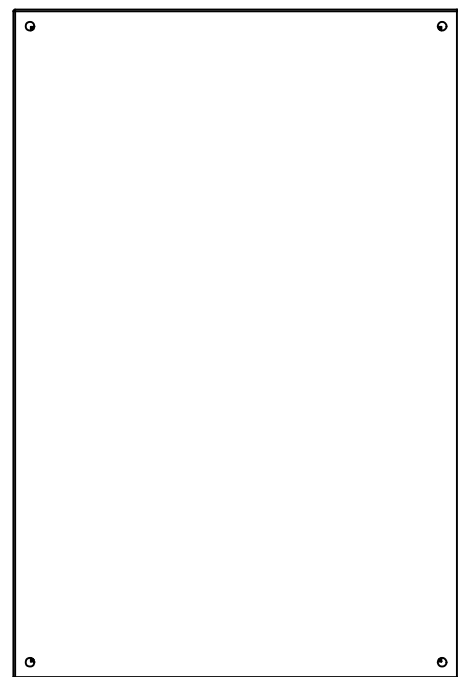

BACK

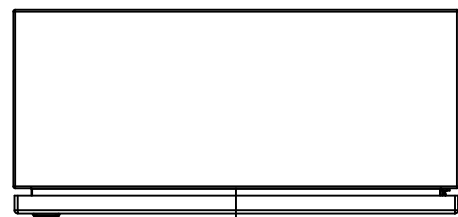

BOTTOM

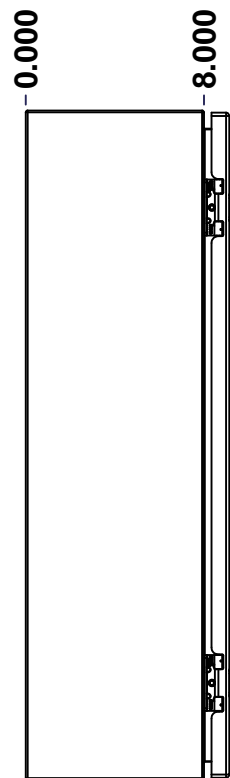

LEFT

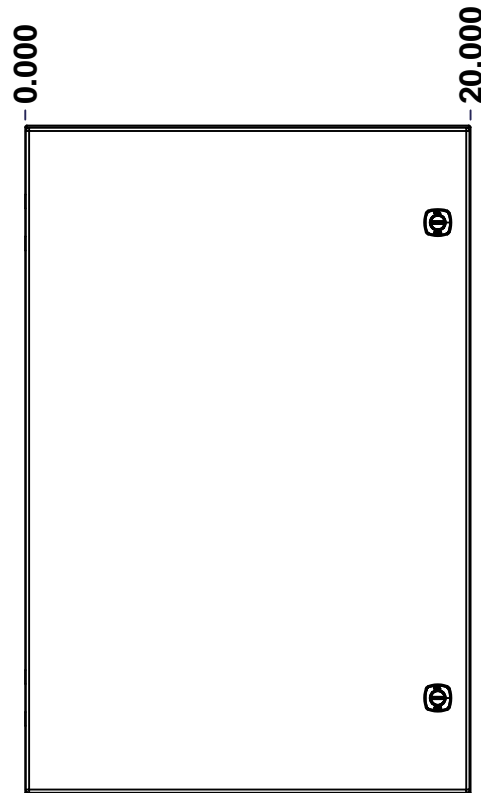

FRONT

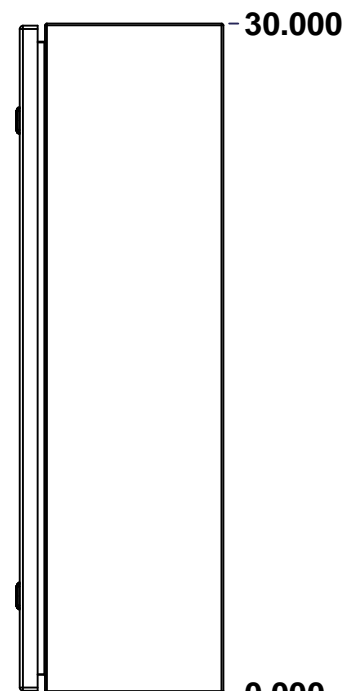

RIGHT

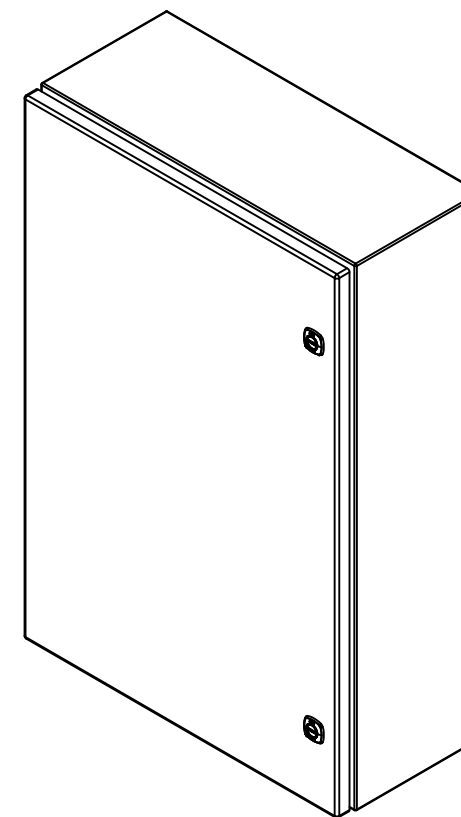

Isometric View



Tél: (450) 979-4373  
 Fax: (450) 979-4626  
[www.exmweb.com](http://www.exmweb.com)

Flatness  
Aplatissement

Max 3.0mm

Projection

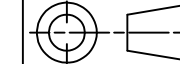

Customer Client	Date
Drawn By / Dessiné Par: BoxCad: BoxCad	Date: 06-May-22

Material / Matière: 16 Ga Stainless Steel 316 (1.4mm)

Color / Couleur: Unpainted	Finish / Fini: Brushed
----------------------------	------------------------

Description: 5412ESS 30" x 20" x 8" Assembly	Detail Rev.
--	-------------

Part Number / Numéro Pièce: 5412ESS3020086NOIP	Rev. 1	2
	0	

**GRAIN DIRECTION:  
 TOP/BOTTOM: HORIZONTAL  
 LEFT/RIGHT/BACK/FRONT: VERTICAL**

SEE BILL OF MATERIAL ON LAST PAGE

This drawing is confidential and must not be reproduced or used without the consent of EXM

Ce dessin est confidentiel et ne doit pas être reproduit ou utilisé sans le consentement de EXM

NOTE	
ITEM	DESCRIPTION
1	NEMA 4X Enclosure
2	C/W Standard ground studs on box and cover
3	C/W Standard door stiffener
4	W/O Inner panel
5	C/W Standard inner panel mounting studs

No.	Revisions	Date	By/Par

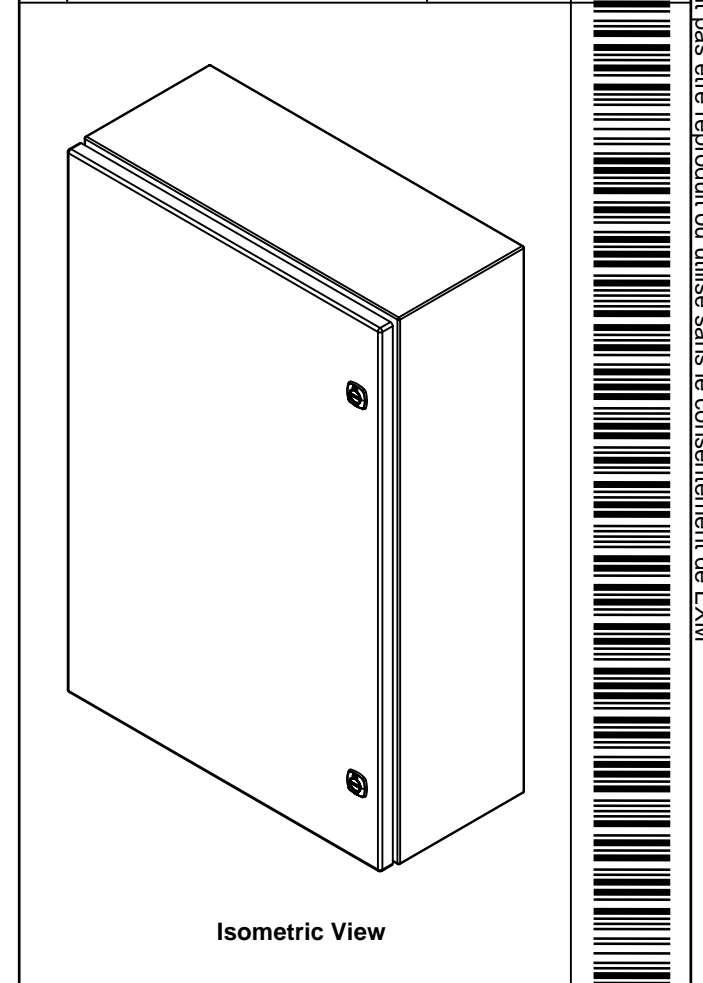

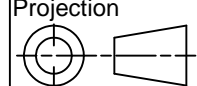
 Tél: (450) 979-4373 Fax: (450) 979-4626 <a href="http://www.exmweb.com">www.exmweb.com</a>		Flatness Aplatissement Max 3.0mm Projection 
Customer Client	Date	
Drawn By Dessiné Par	BoxCad: BoxCad	Date 06-May-22
Material Matière	16 Ga Stainless Steel 316 (1.4mm)	
Color Couleur	Unpainted	Finish Fini Brushed
Description		Detail Rev.
5412ESS 30" x 20" x 8" Assembly		
Part Number Numéro Pièce	5412ESS3020086NOIP	Rev. 0

PACKING		
ITEM	QTY	DESCRIPTION
Cardboard sleeve	2	Top and Bottom
Cardboard strip	2	Between back of enclosure and inner panel
Plastic bag	1	To protect cover surface and inside gasket
Plastic strap - Black	2	To Squeeze the 2 cardboard sleeve together
Packaging label	1	White label with product number

1	880 PP	6	Self Adhesive Print Pocket
1	STK-K-01800	5	5412 ES Accessory Kit
1	5412ESS3020086NOIPC	0	5412ESS 30" x 20" Cover
1	5412ESS3020086NOIPB	0	5412ESS 30" x 20" x 8" Body
2	STK-Q-04051-07	8	M6 x 7mm Stainless Steel Hexagon Socket Head Machine Screw with Nyseal
Qty	Part Number	Rev	Description
Parts List			

This drawing is confidential and must not be reproduced or used without the consent of EXM

Ce dessin est confidentiel et ne doit pas être reproduit ou utilisé sans le consentement de EXM

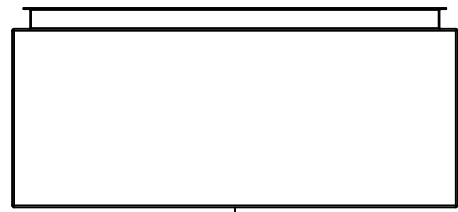

TOP

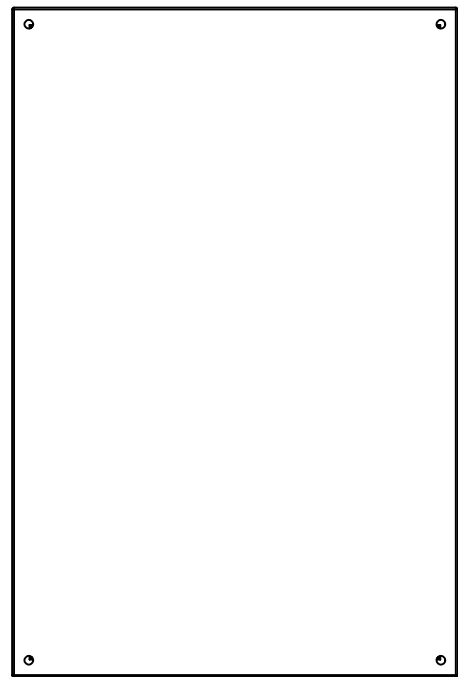

BACK

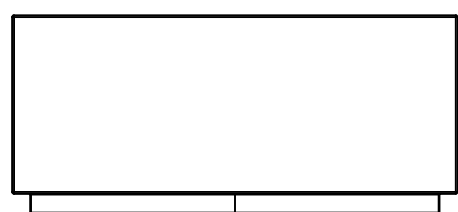

BOTTOM

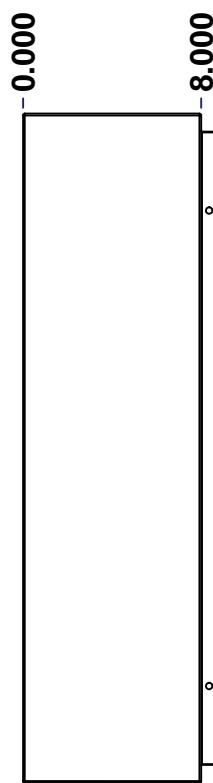

LEFT

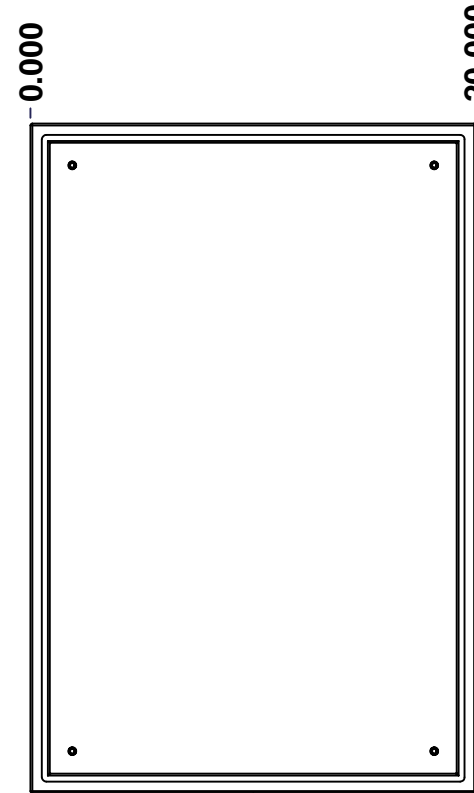

FRONT

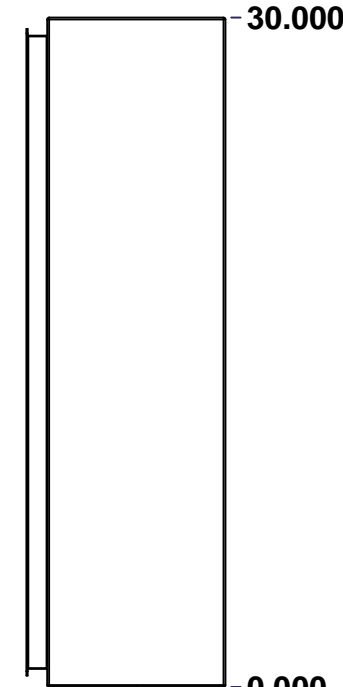

RIGHT

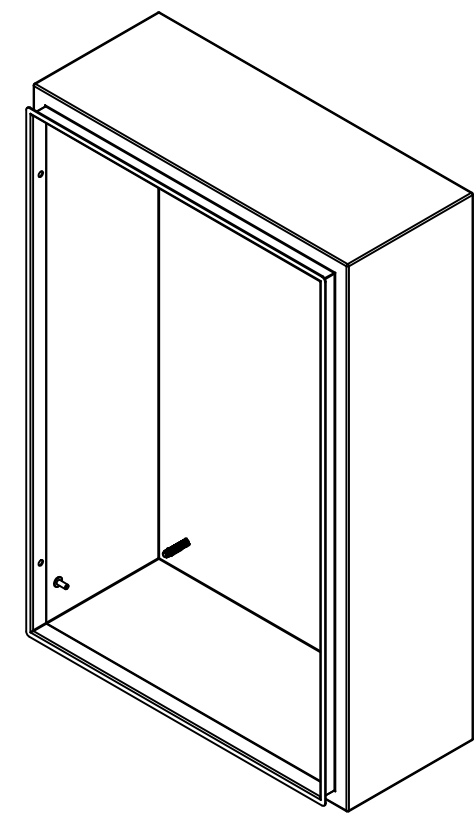

Isometric View

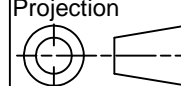

No.	Revisions	Date	By/Par

 Tél: (450) 979-4373 Fax: (450) 979-4626 <a href="http://www.exmweb.com">www.exmweb.com</a>		Flatness Aplatissement Max 3.0mm Projection 
Customer Client	Date	
Drawn By Dessiné Par	BoxCad: BoxCad	Date 06-May-22
Material Matière	16 Ga Stainless Steel 316 (1.4mm)	
Color Couleur	Unpainted	Finish Fini Brushed
Description	Detail Rev.	
5412ESS 30" x 20" x 8" Body		
Part Number Numéro Pièce	Rev.	1 7
5412ESS3020086NOIPB	0	

SEE BILL OF MATERIAL ON LAST PAGE

This drawing is confidential and must not be reproduced or used without the consent of EXM

Ce dessin est confidentiel et ne doit pas être reproduit ou utilisé sans le consentement de EXM

**STANDARD FEATURES ARE NOT LISTED IN THIS HOLE TABLE**

**HOLE TABLE - LEFT VIEW (CUSTOM FEATURE ONLY)**

CUT-OUT	XDIM	YDIM	DESCRIPTION
1	6.500	2.000	GND STUD M6 x 16mm (Inside)

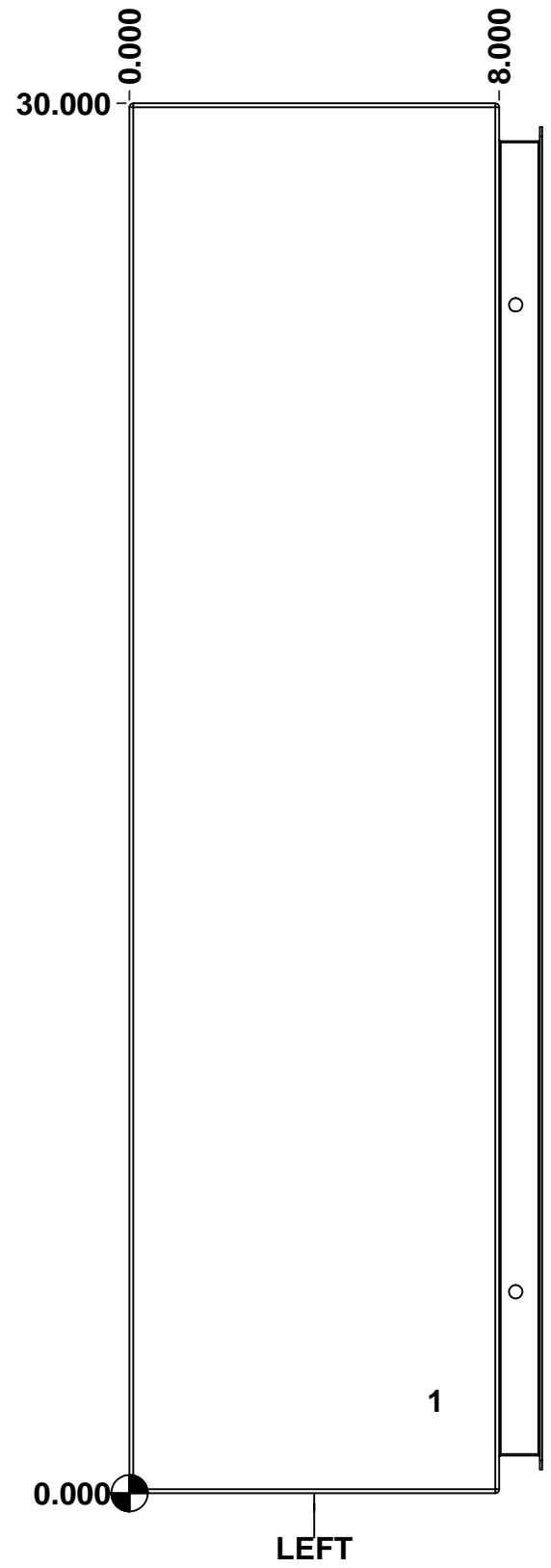

	Description	Status	
	5412ESS 30" x 20" x 8" Body		
	Part Number Numéro Pièce	Rev.	
	<b>5412ESS3020086NOIPB</b>	<b>0</b>	5 / 7

This drawing is confidential and must not be reproduced or used without the consent of EXM

Ce dessin est confidentiel et ne doit pas être reproduit ou utilisé sans le consentement de EXM

**STANDARD FEATURES ARE NOT LISTED IN THIS HOLE TABLE**

**HOLE TABLE - BACK VIEW (CUSTOM FEATURE ONLY)**

CUT-OUT	XDIM	YDIM	DESCRIPTION
1	1.875	1.875	IP STUD M8 x 35mm (Inside)
2	1.875	28.125	IP STUD M8 x 35mm (Inside)
3	18.125	28.125	IP STUD M8 x 35mm (Inside)
4	18.125	1.875	IP STUD M8 x 35mm (Inside)
-----			
5	19.250	0.750	RND Ø0.390
6	19.250	29.250	RND Ø0.390
7	0.750	29.250	RND Ø0.390
8	0.750	0.750	RND Ø0.390

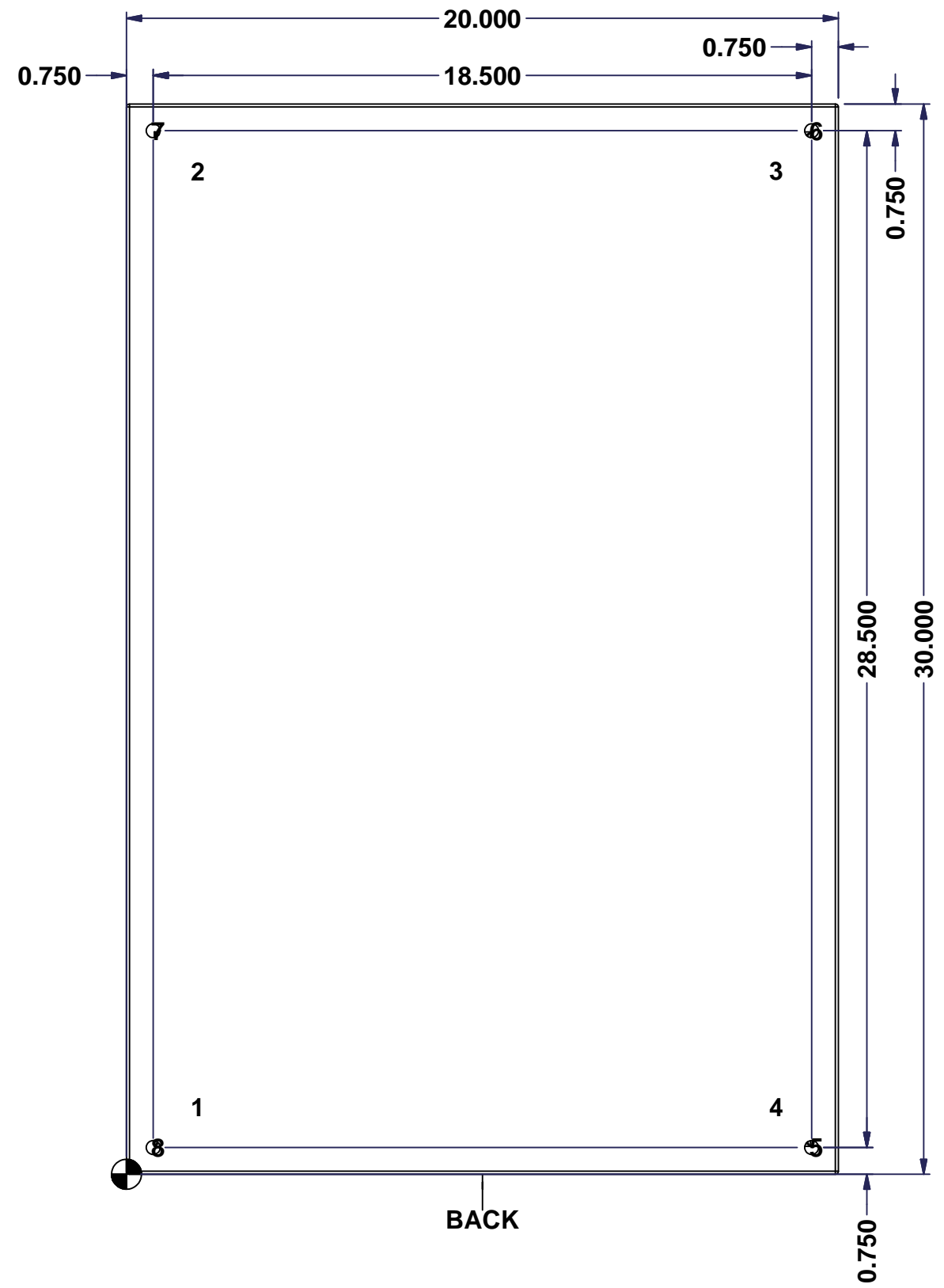

BACK

	Description	Status
	5412ESS 30" x 20" x 8" Body	
	Part Number Numéro Pièce	Rev.
	<b>5412ESS3020086NOIPB</b>	<b>0</b>
		6 / 7

This drawing is confidential and must not be reproduced or used without the consent of EXM

Ce dessin est confidentiel et ne doit pas être reproduit ou utilisé sans le consentement de EXM

No.	Revisions	Date	By/Par

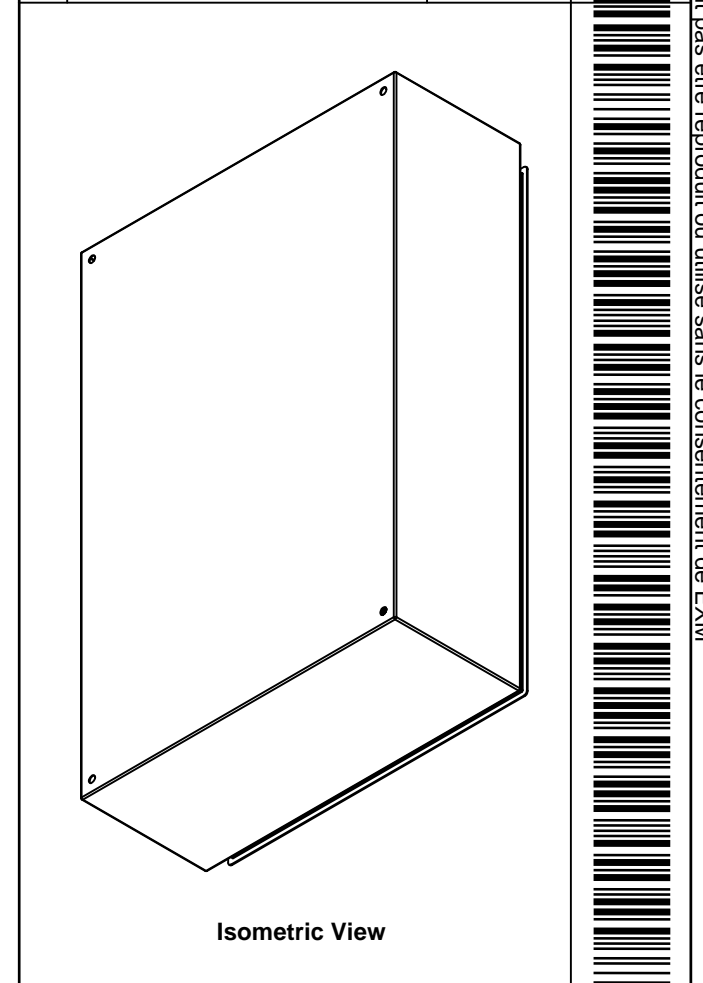

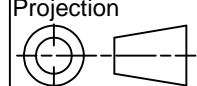
 Tél: (450) 979-4373 Fax: (450) 979-4626 <a href="http://www.exmweb.com">www.exmweb.com</a>		Flatness Aplatissement Max 3.0mm Projection 
Customer Client	Date	
Drawn By Dessiné Par	BoxCad: BoxCad	Date 06-May-22
Material Matière	16 Ga Stainless Steel 316 (1.4mm)	
Color Couleur	Unpainted	Finish Fini Brushed
Description		Detail Rev.
5412ESS 30" x 20" x 8" Body		
Part Number Numéro Pièce	Rev.	7
<b>5412ESS3020086NOIPB</b>	<b>0</b>	7

Qty	Part Number	Rev	Description
1	STK-Q-16085	0	Ground Stud M6 x 16mm Stainless Steel
4	STK-Q-16020	1	Stud M8 x 35mm Stainless Steel
1	5412ESS3020086NOIPB-P	0	5412ESS 30" x 20" x 8" Body Part
Parts List			

This drawing is confidential and must not be reproduced or used without the consent of EXM

Ce dessin est confidentiel et ne doit pas être reproduit ou utilisé sans le consentement de EXM

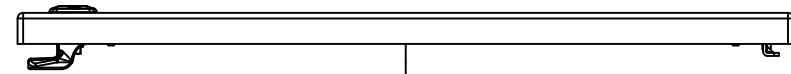

TOP

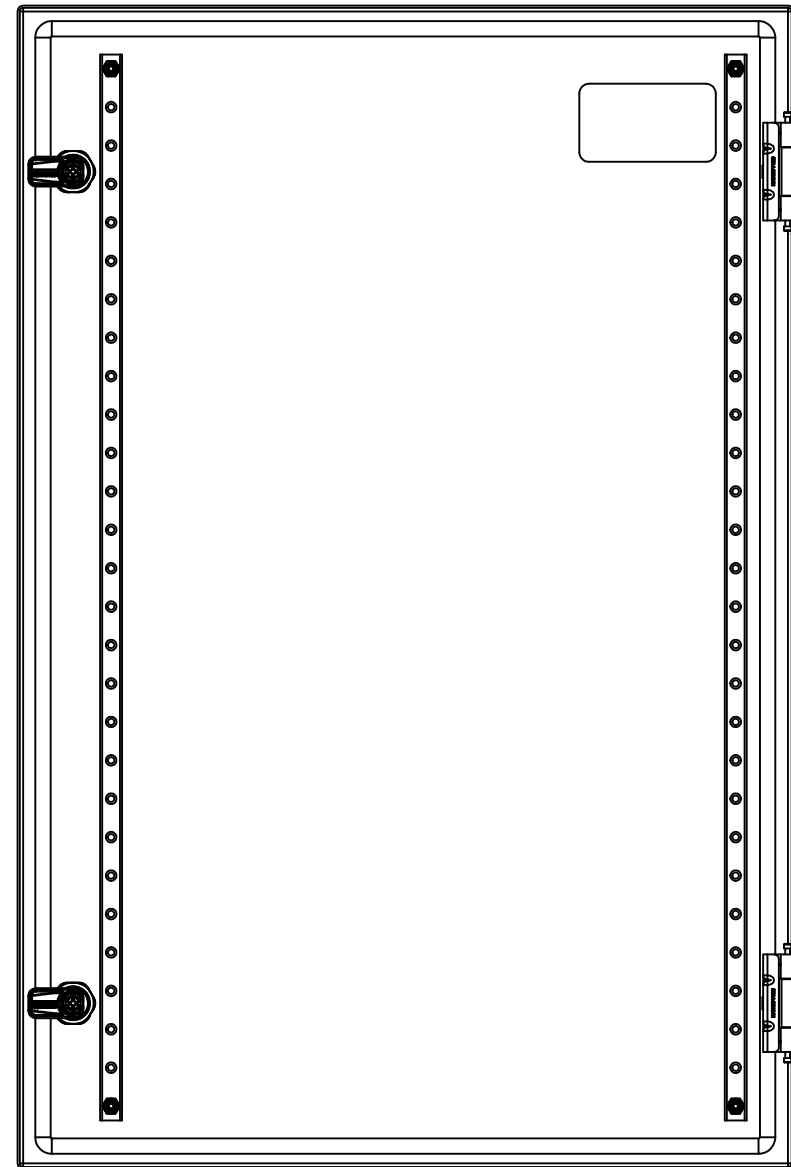

BACK

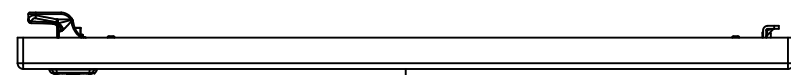

BOTTOM

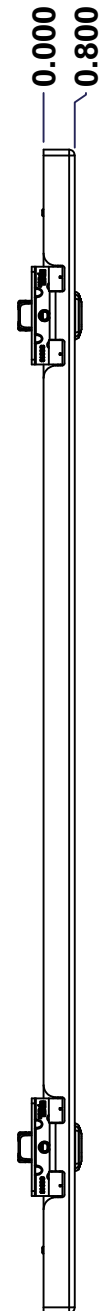

LEFT

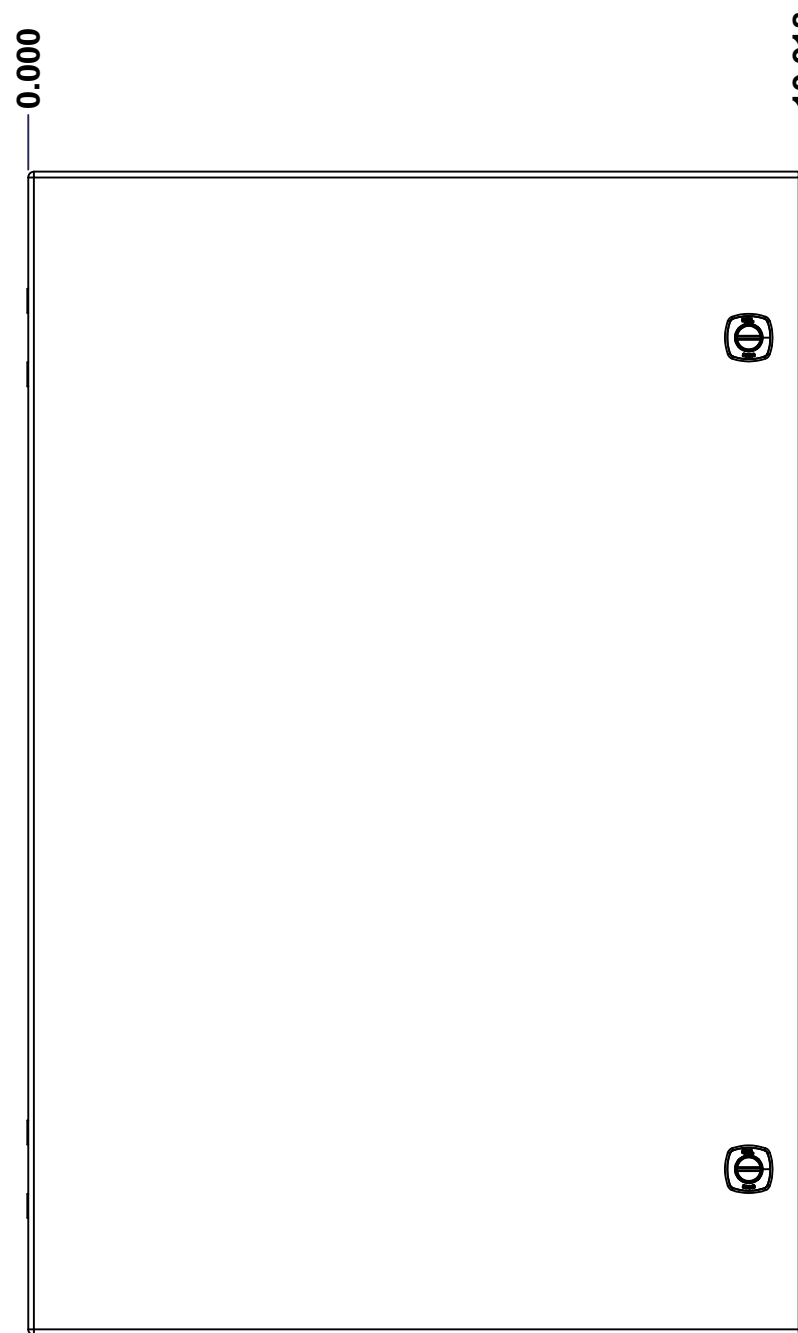

FRONT

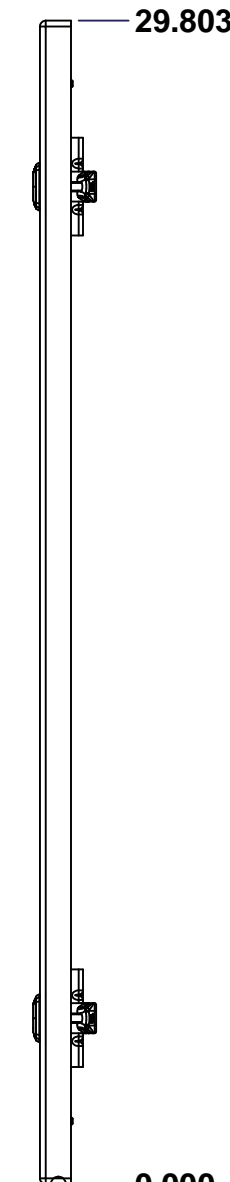

RIGHT

No.	Revisions	Date	By/Par

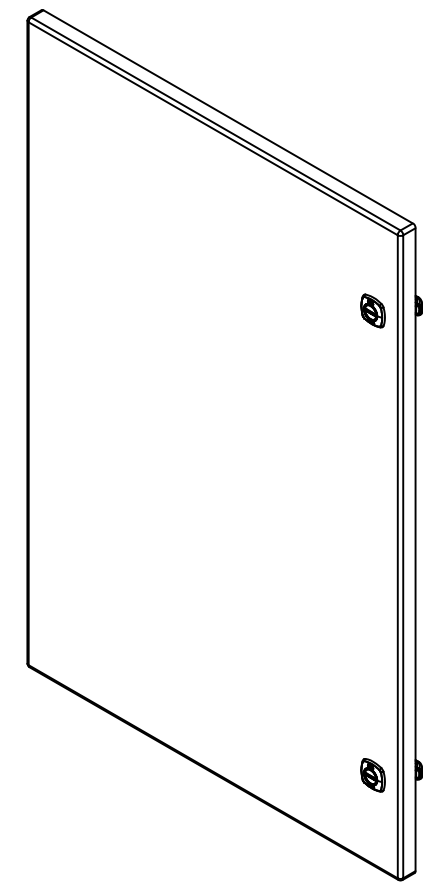

Isometric View

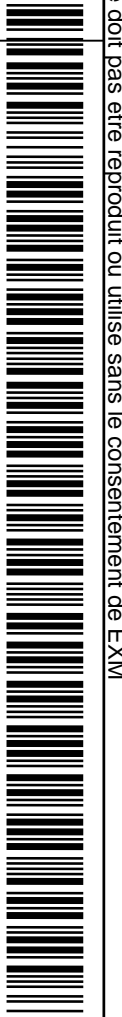

Tél: (450) 979-4373  
 Fax: (450) 979-4626  
[www.exmweb.com](http://www.exmweb.com)

Flatness Aplatissement	Max 3.0mm
Projection	

Customer Client	Date
Drawn By Dessiné Par BoxCad: BoxCad	Date 06-May-22
Material Matière 16 Ga Stainless Steel 316 (1.4mm)	
Color Couleur Unpainted	Finish Fini Brushed
Description 5412ESS 30" x 20" Cover	Detail Rev.
Part Number Numéro Pièce <b>5412ESS3020086NOIPC</b>	Rev. <b>0</b>

SEE BILL OF MATERIAL ON LAST PAGE

1	3
0	

This drawing is confidential and must not be reproduced or used without the consent of EXM

Ce dessin est confidentiel et ne doit pas être reproduit ou utilisé sans le consentement de EXM

**STANDARD FEATURES ARE NOT LISTED IN THIS HOLE TABLE**

**HOLE TABLE - FRONT VIEW (CUSTOM FEATURE ONLY)**

CUT-OUT	XDIM	YDIM	DESCRIPTION
1	1.486	1.614	STUD M6 x 18mm (Inside)
2	1.486	28.189	STUD M6 x 18mm (Inside)
3	17.517	28.189	STUD M6 x 18mm (Inside)
4	17.517	1.614	STUD M6 x 18mm (Inside)
-----			
5	3.750	26.803	LABEL_EXM (Inside)
6	18.494	25.553	LOCK 880 SCQ4-SLSS6 @ 0.0°
7	18.494	4.250	LOCK 880 SCQ4-SLSS6 @ 0.0°

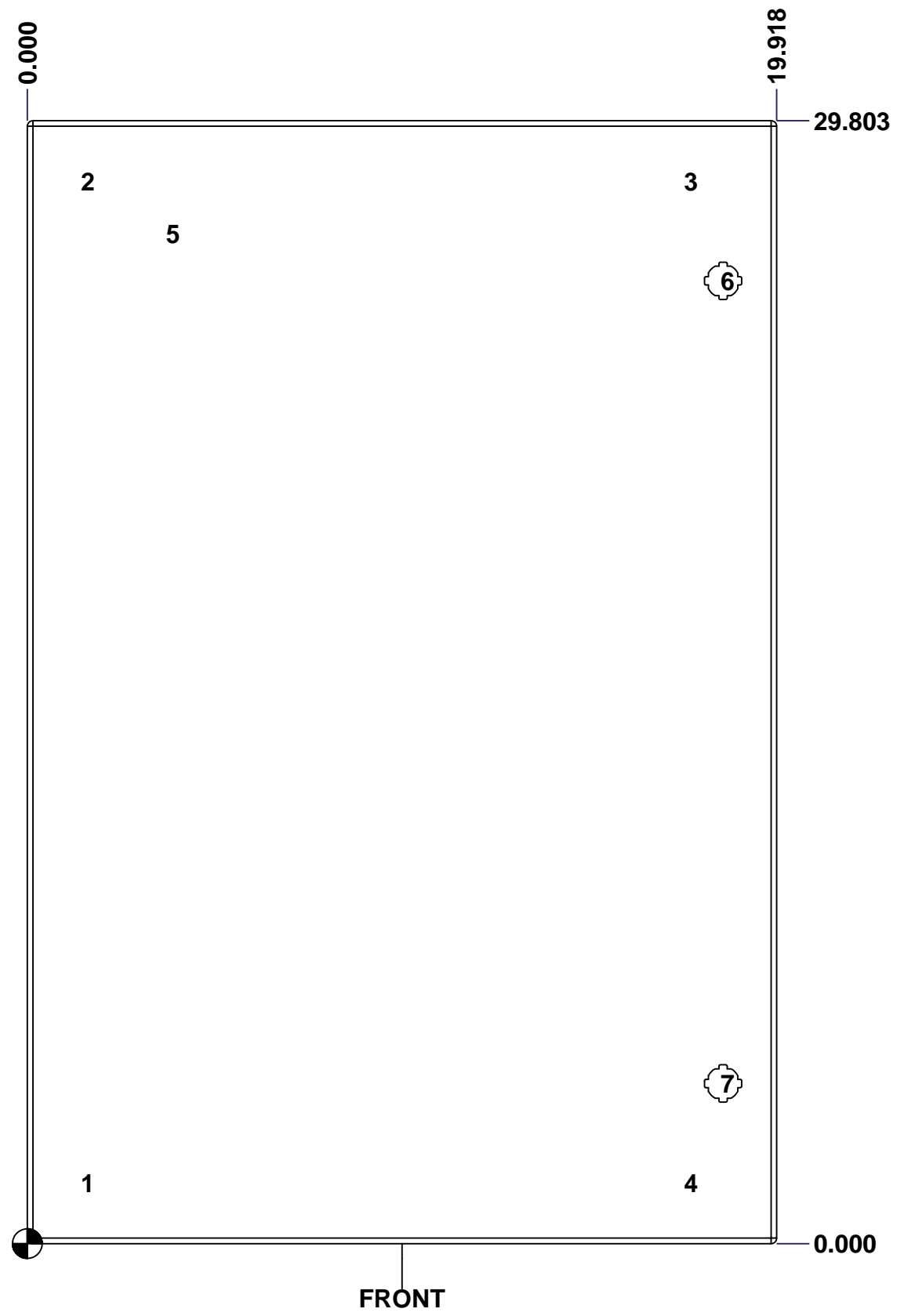

	Description	Status
	5412ESS 30" x 20" Cover	(NULL)
	Part Number Numéro Pièce	Rev.
	<b>5412ESS3020086NOIPC</b>	<b>0</b>
		2
		3



This drawing is confidential and must not be reproduced or used without the consent of EXM

Ce dessin est confidentiel et ne doit pas être reproduit ou utilisé sans le consentement de EXM

No.	Revisions	Date	By/Par

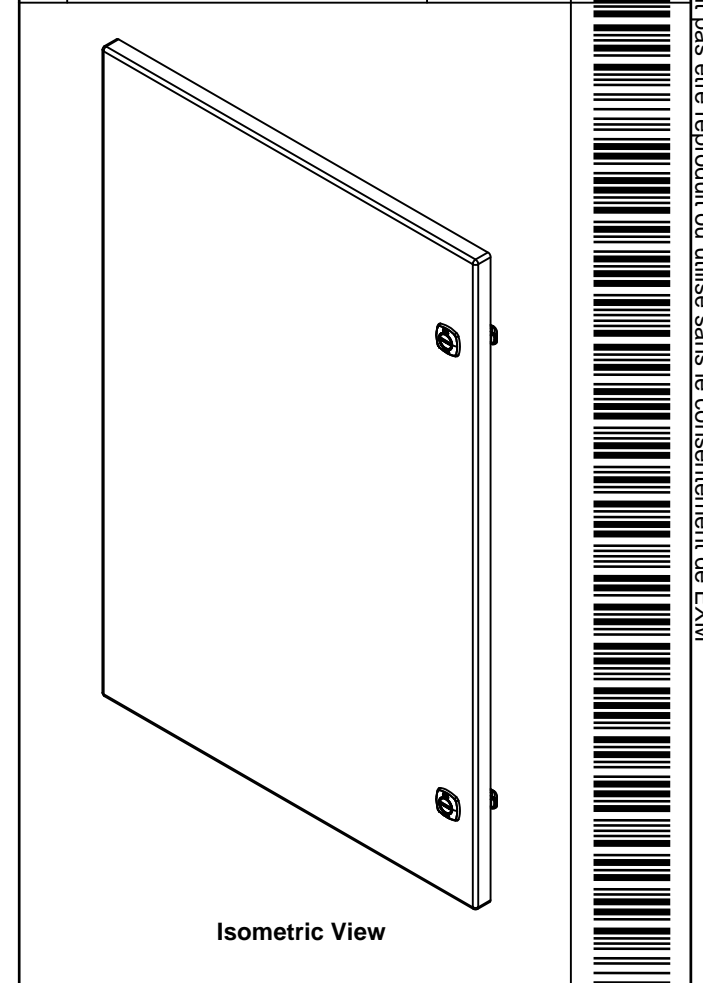

 Tél: (450) 979-4373  
 Fax: (450) 979-4626  
[www.exmweb.com](http://www.exmweb.com)

Flatness / Aplatissement: Max 3.0mm  
 Projection: 

Customer / Client:   
 Date: 06-May-22

Drawn By / Dessiné Par: BoxCad: BoxCad

Material / Matière: 16 Ga Stainless Steel 316 (1.4mm)

Color / Couleur: Unpainted      Finish / Fini: Brushed

Description: 5412ESS 30" x 20" Cover      Detail Rev.:

Qty	Part Name	Rev	Description
1	STK-S-00100	0	3.5" x 2" Silver Milar Flexcon Sticker
2	STK-Q-46020-30	5	5412 ES Vertical Door Stiffener 30"
4	STK-Q-16070	1	Stud M6 x 18mm Stainless steel
1	5412ESS3020086NOIPG	0	5412ESS 30" x 20" Cover Gasket Part
1	5412ESS3020086NOIPC-P	0	5412ESS 30" x 20" Cover Part
2	STK-A-33016	0	5412 ESS Bended Hinge (Body Part)
2	880 SCQ4-SLSS6	7	5412 ESS 1/4 Turn Lock
4	STK-Q-07220	1	M6 Nylon Insert Lock Nut
Parts List			

Part Number / Numéro Pièce: **5412ESS3020086NOIPC**      Rev. **0**      3