

This drawing is confidential and must not be reproduced or used without the consent of EXM

Ce dessin est confidentiel et ne doit pas être reproduit ou utilisé sans le consentement de EXM

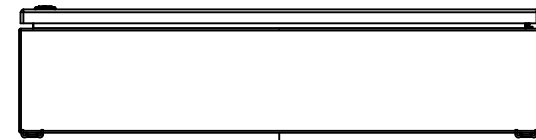

TOP

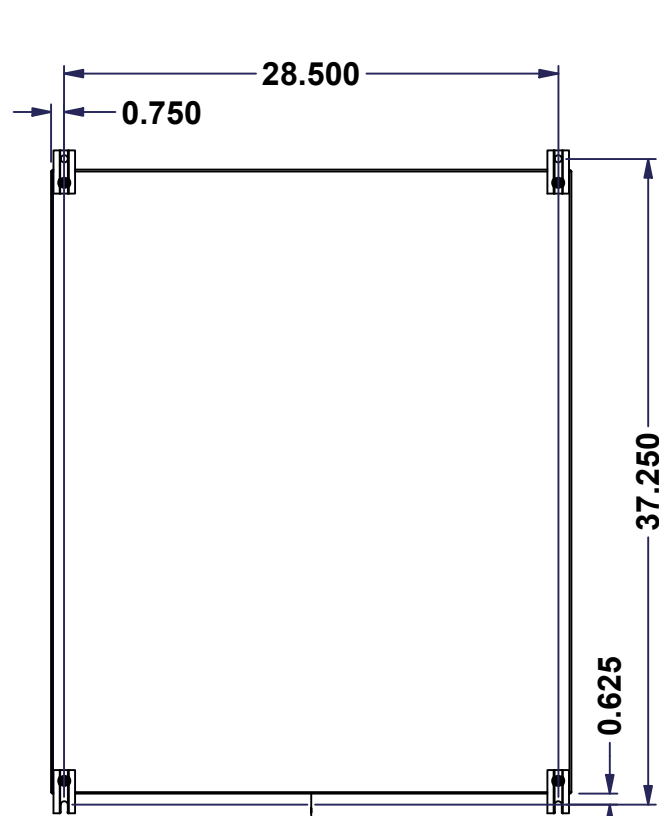

BACK

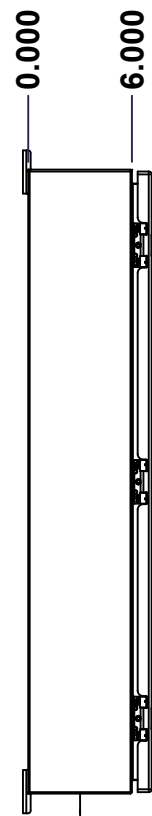

LEFT

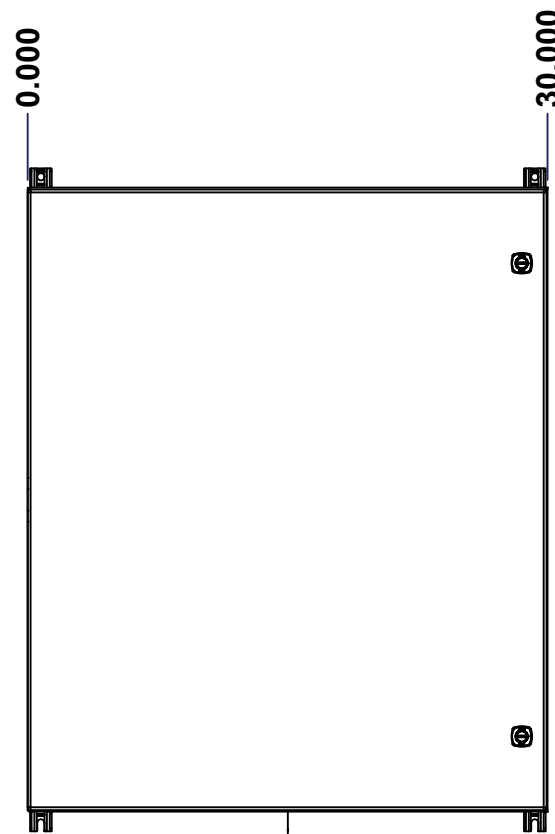

FRONT

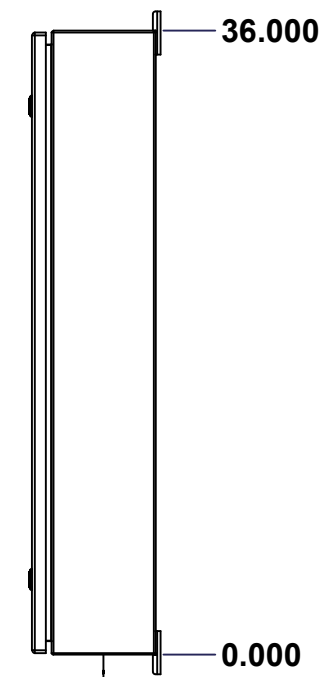

RIGHT

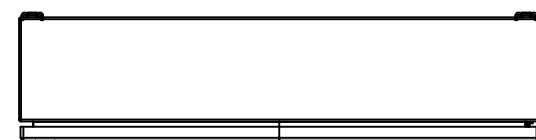

BOTTOM

No.	Revisions	Date	By/Par

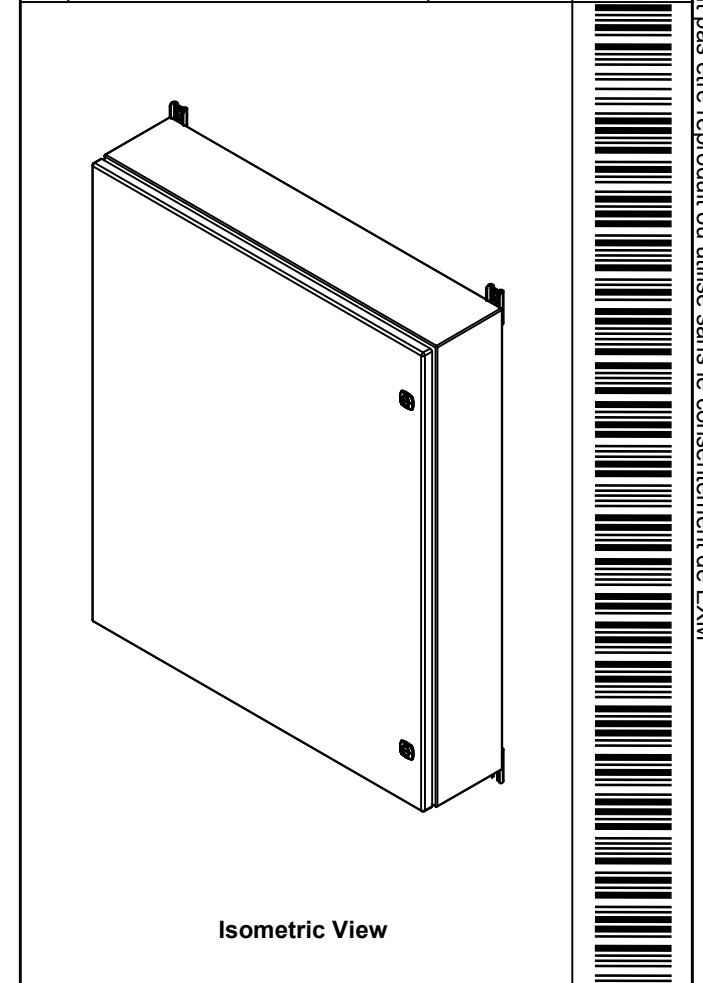

Isometric View

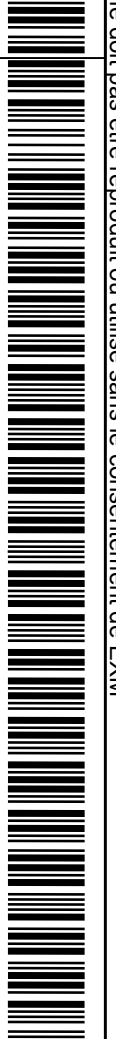

**GRAIN DIRECTION:
TOP/BOTTOM: HORIZONTAL
LEFT/RIGHT/BACK/FRONT: VERTICAL**

	Flatness Aplatissement Max 3.0mm
	Projection
Customer Client	Date
Drawn By Dessiné Par: BoxCad: BoxCad	Date: 26-May-23
Material Matière: 14 Ga Stainless Steel 316 (1.7mm)	
Color Couleur: Unpainted	Finish Fini: Brushed
Description 5412ESS 36" x 30" x 6" Assembly	
Part Number Numéro Pièce: 5412ESS3630066THNOIP	Detail Rev. Rev. 1 0

SEE BILL OF MATERIAL ON LAST PAGE

5412ESS3630066THNOIP

This drawing is confidential and must not be reproduced or used without the consent of EXM

Ce dessin est confidentiel et ne doit pas être reproduit ou utilisé sans le consentement de EXM

NOTE	
ITEM	DESCRIPTION
1	NEMA 4X Enclosure
2	C/W Standard ground studs on box and cover
3	C/W Standard door stiffener
4	W/O Inner panel
5	C/W Standard inner panel mounting studs
6	C/W 885 ESMF4_OPEN Sold separately (Installed)
7	C/W 885 ESMF4_CLOSE Sold separately (Installed)
8	C/W R5 Insulation (Installed by EXM)

No.	Revisions	Date	By/Par

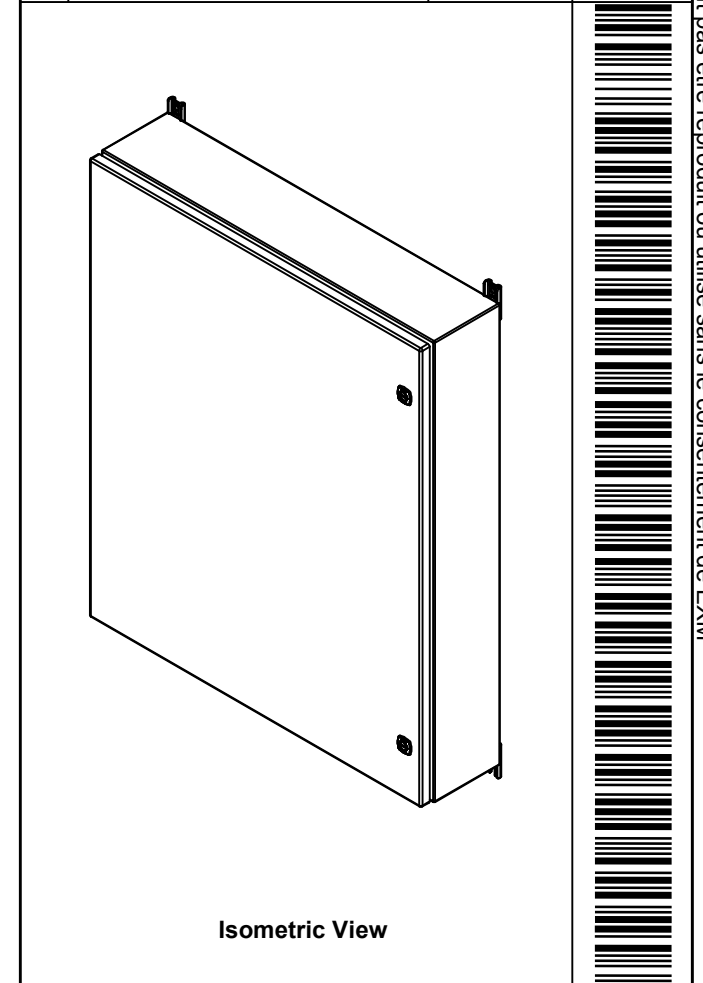



Tél: (450) 979-4373
Fax: (450) 979-4626
www.exmweb.com

Flatness
Aplatissement
Max 3.0mm

Projection



Customer Client	Date
Drawn By Dessiné Par BoxCad: BoxCad	Date 26-May-23

Material Matière 14 Ga Stainless Steel 316 (1.7mm)

Color Couleur Unpainted	Finish Fini Brushed
-------------------------	---------------------

Description 5412ESS 36" x 30" x 6" Assembly

Detail Rev.

Part Number Numéro Pièce	Rev.	2
5412ESS3630066THNOIP	0	16

Qty	Part Number	Rev	Description
6	STK-Q-00600	2	M12 to M8 Adaptor
1	STK-K-01800	5	5412 ES Accessory Kit
1	5412ESS3630066THNOIP C	0	5412ESS 36" x 30" Cover
1	5412ESS3630066THNOIP B	0	5412ESS 36" x 30" x 6" Body
3	STK-Q-04051-08	1	M6 x 8mm Stainless Steel Hexagon Socket Head Machine Screw with Nyseal
Parts List			

PACKING		
ITEM	QTY	DESCRIPTION
Cardboard sleeve	2	Top and Bottom
Cardboard strip	2	Between back of enclosure and inner panel
Plastic bag	1	To protect cover surface and inside gasket
Plastic strap - Black	2	To Squeeze the 2 cardboard sleeve together
Packaging label	1	White label with product number

This drawing is confidential and must not be reproduced or used without the consent of EXM

Ce dessin est confidentiel et ne doit pas être reproduit ou utilisé sans le consentement de EXM

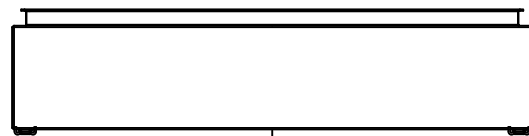

TOP

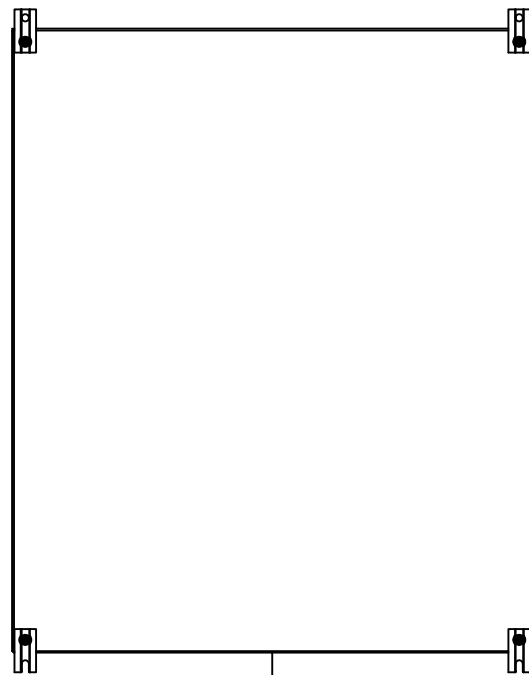

BACK

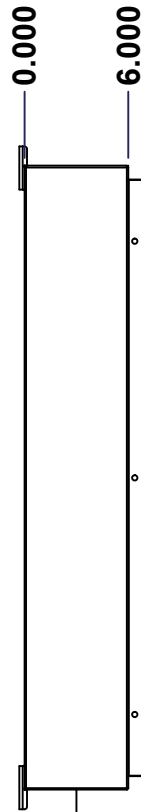

LEFT

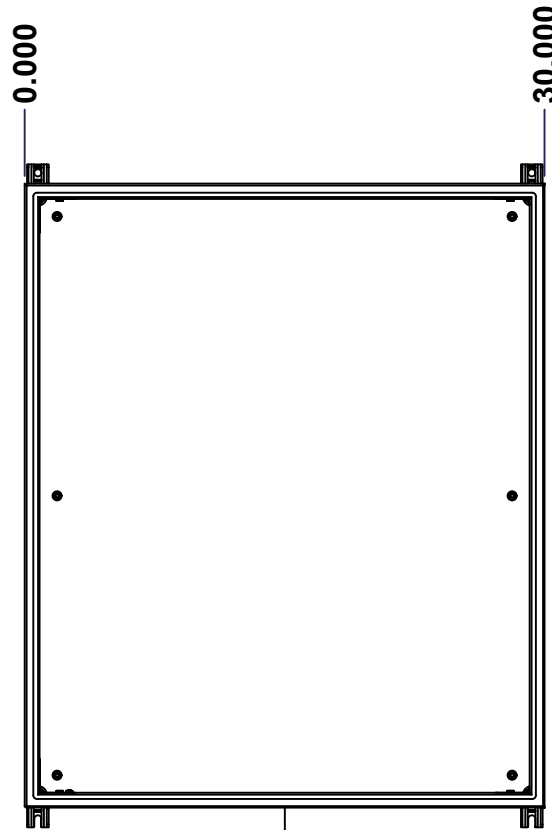

FRONT



RIGHT

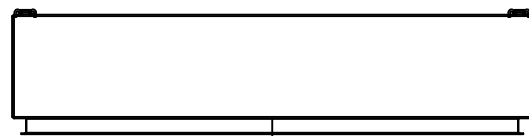

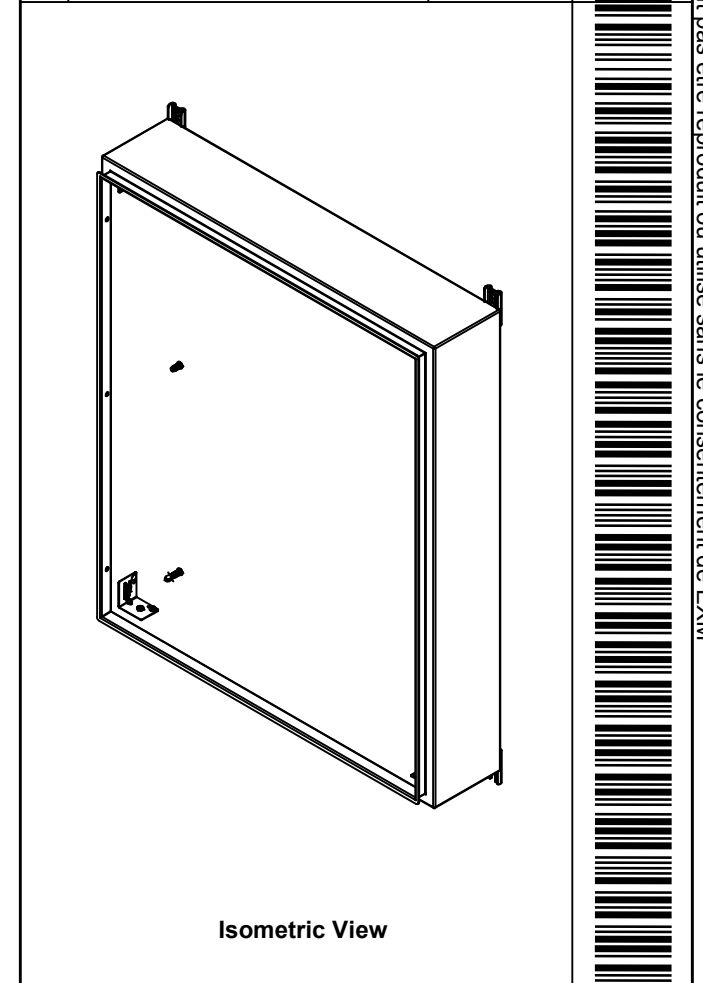

BOTTOM

No.	Revisions	Date	By/Par



Isometric View

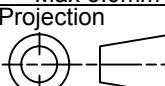

 Tél: (450) 979-4373 Fax: (450) 979-4626 www.exmweb.com		Flatness Aplatissement  Max 3.0mm
Customer Client	Date	Projection 
Drawn By Dessiné Par	BoxCad: BoxCad	Date 26-May-23
Material Matière	14 Ga Stainless Steel 316 (1.7mm)	
Color Couleur	Unpainted	Finish Fini Brushed
Description	Detail Rev.	
5412ESS 36" x 30" x 6" Body		
Part Number Numéro Pièce	Rev.	3
SEE BILL OF MATERIAL ON LAST PAGE 5412ESS3630066THNOIPB	0	16

This drawing is confidential and must not be reproduced or used without the consent of EXM

Ce dessin est confidentiel et ne doit pas être reproduit ou utilisé sans le consentement de EXM

STANDARD FEATURES ARE NOT LISTED IN THIS HOLE TABLE			
HOLE TABLE - TOP VIEW (CUSTOM FEATURE ONLY)			
CUT-OUT	XDIM	YDIM	DESCRIPTION
1	2.000	4.500	INSUL. STUD M6 x 18mm (Inside)
2	28.000	4.500	INSUL. STUD M6 x 18mm (Inside)

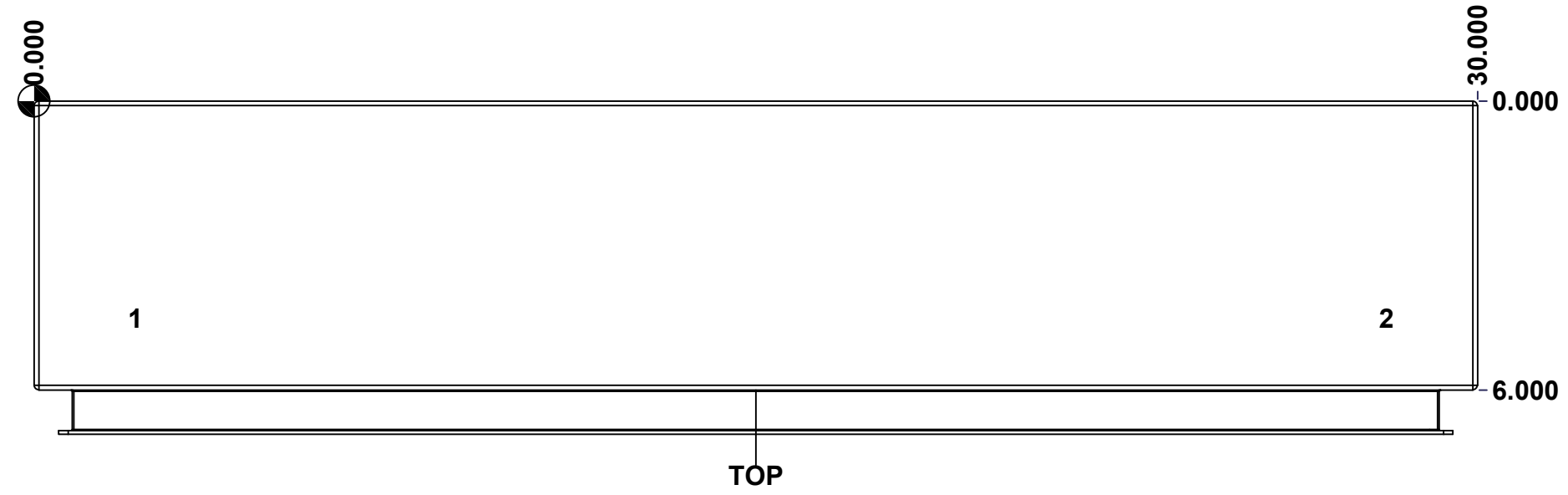

	Description	Status
	5412ESS 36" x 30" x 6" Body	(NULL)
	Part Number Numéro Pièce	Rev.
	5412ESS3630066THNOIPB	0
		4
		16

This drawing is confidential and must not be reproduced or used without the consent of EXM

Ce dessin est confidentiel et ne doit pas être reproduit ou utilisé sans le consentement de EXM

STANDARD FEATURES ARE NOT LISTED IN THIS HOLE TABLE			
HOLE TABLE - BOTTOM VIEW (CUSTOM FEATURE ONLY)			
CUT-OUT	XDIM	YDIM	DESCRIPTION
1	2.000	4.500	INSUL. STUD M6 x 18mm (Inside)
2	28.000	4.500	INSUL. STUD M6 x 18mm (Inside)

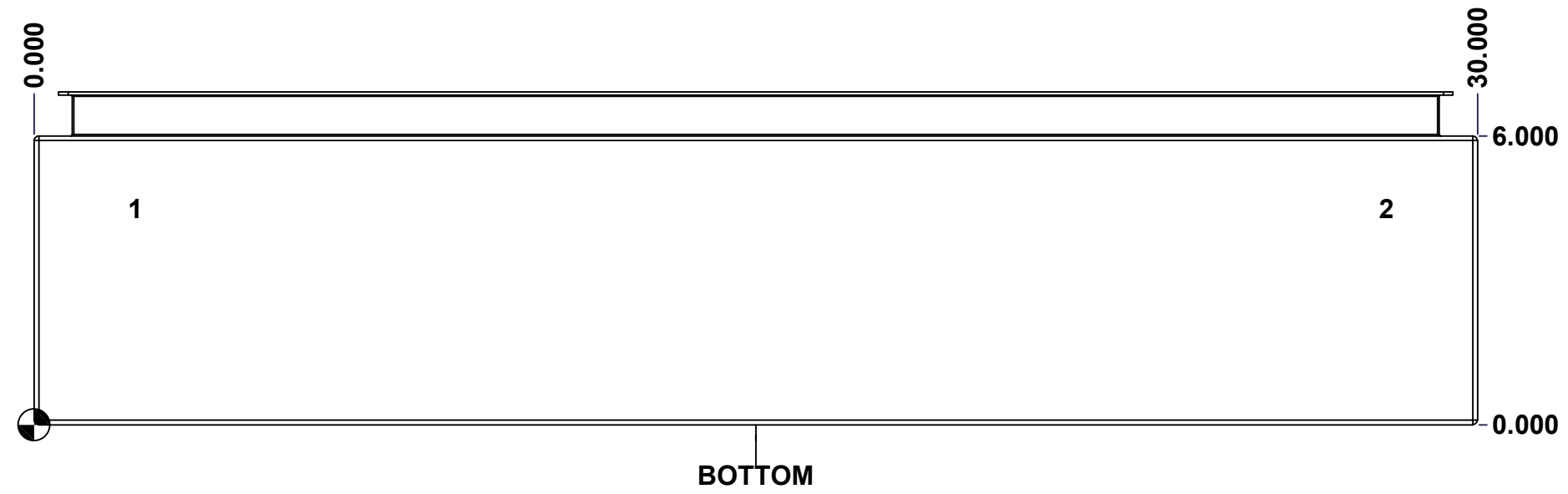

	Description	Status
	5412ESS 36" x 30" x 6" Body	(NULL)
	Part Number Numéro Pièce	Rev.
	5412ESS3630066THNOIPB	0
		5
		16

This drawing is confidential and must not be reproduced or used without the consent of EXM

Ce dessin est confidentiel et ne doit pas être reproduit ou utilisé sans le consentement de EXM

STANDARD FEATURES ARE NOT LISTED IN THIS HOLE TABLE

HOLE TABLE - BACK VIEW (CUSTOM FEATURE ONLY)

CUT-OUT	XDIM	YDIM	DESCRIPTION
1	1.875	1.875	IP STUD M8 x 35mm (Inside)
2	1.875	34.125	IP STUD M8 x 35mm (Inside)
3	28.125	34.125	IP STUD M8 x 35mm (Inside)
4	28.125	1.875	IP STUD M8 x 35mm (Inside)
5	1.875	18.000	IP STUD M8 x 35mm (Inside)
6	28.125	18.000	IP STUD M8 x 35mm (Inside)

7	29.250	0.000	FOOT 885 ESMF4_OPEN
8	0.750	0.000	FOOT 885 ESMF4_OPEN
9	29.250	36.000	FOOT 885 ESMF4_CLOSE
10	0.750	36.000	FOOT 885 ESMF4_CLOSE

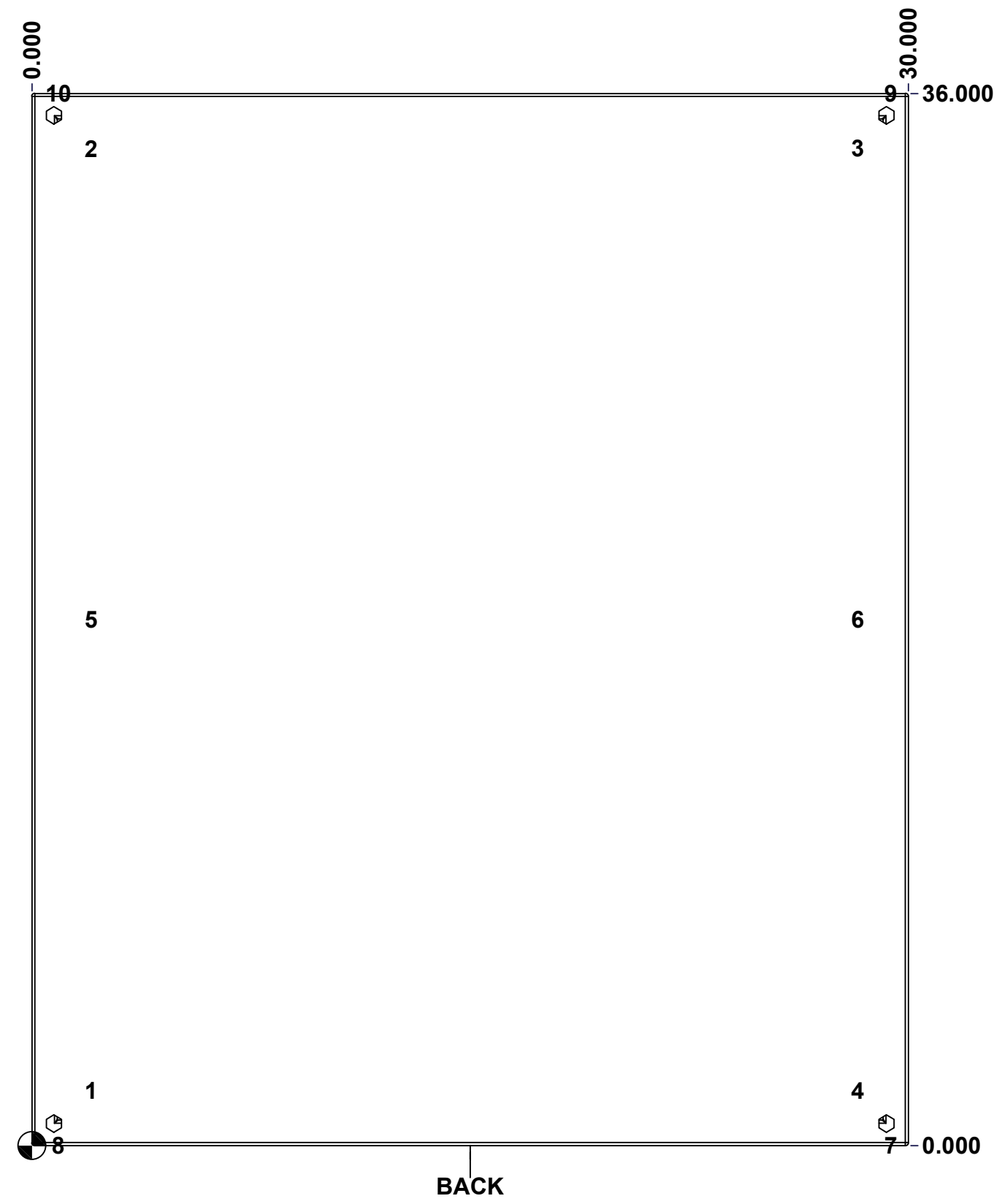

	Description	Status
	5412ESS 36" x 30" x 6" Body	(NULL)
	Part Number Numéro Pièce	Rev.
	5412ESS3630066THNOIPB	0 / 6
		16

This drawing is confidential and must not be reproduced or used without the consent of EXM

Ce dessin est confidentiel et ne doit pas être reproduit ou utilisé sans le consentement de EXM

No.	Revisions	Date	By/Par

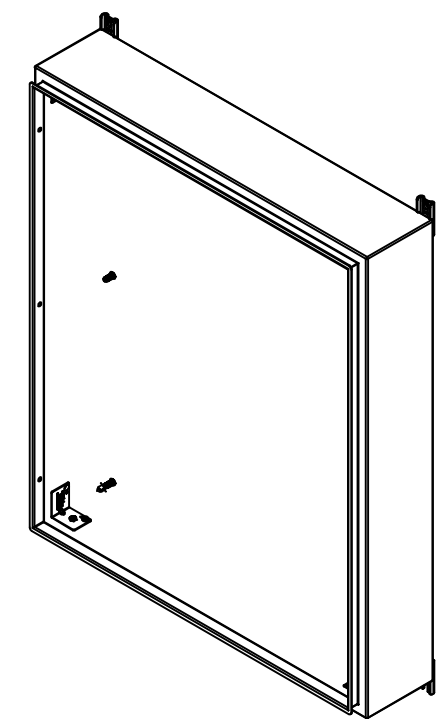

Isometric View



2	885ESMF4-FEET	0	885 ESMF4 Stainless Steel Mounting Foot
4	RIVET_NUT_SS_M10_FH _CE	0	Stainless Steel Rivet Nut M10 (Low Profile Close End)
4	STK-Q-06670	2	M10 x 16mm Stainless Steel Machine Screw
2	885ESMF4-FEET-A	0	885 ESMF4 Stainless Steel Mounting Foot (Opened Slot)
1	STK-K-70554	3	5412 ESTH Accessory Kit
1	5412ESS3630066THNOIP I-RS	0	5412ESS 36" x 30" Right Insulation
1	5412ESS3630066THNOIP I-LS	0	5412ESS 36" x 30" Left Insulation
1	5412ESS3630066THNOIP I-BT	0	5412ESS 36" x 30" Top and Bottom Insulation
1	5412ESS3630066THNOIP I-TP	0	5412ESS 36" x 30" Top and Bottom Insulation
1	5412ESS3630066THNOIP I-B	0	5412ESS 36" x 30" Back Insulation
4	STK-Q-16070	1	Stud M6 x 18mm Stainless steel
6	STK-Q-16020	1	Stud M8 x 35mm Stainless Steel
1	5412ESS3630066THNOIP B-P	0	5412ESS 36" x 30" x 6" Body Part
Qty	Part Number	Rev	Description

Parts List

	Tél: (450) 979-4373 Fax: (450) 979-4626 www.exmweb.com	Flatness Aplatissement Max 3.0mm
	Projection	
Customer Client	Date	
Drawn By Dessiné Par: BoxCad: BoxCad	Date	26-May-23
Material Matière	14 Ga Stainless Steel 316 (1.7mm)	
Color Couleur: Unpainted	Finish Fini: Brushed	
Description	5412ESS 36" x 30" x 6" Body	
Part Number Numéro Pièce: 5412ESS3630066THNOIPB	Rev. 0	7 / 16

This drawing is confidential and must not be reproduced or used without the consent of EXM

Ce dessin est confidentiel et ne doit pas être reproduit ou utilisé sans le consentement de EXM

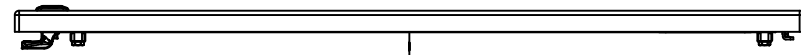

TOP

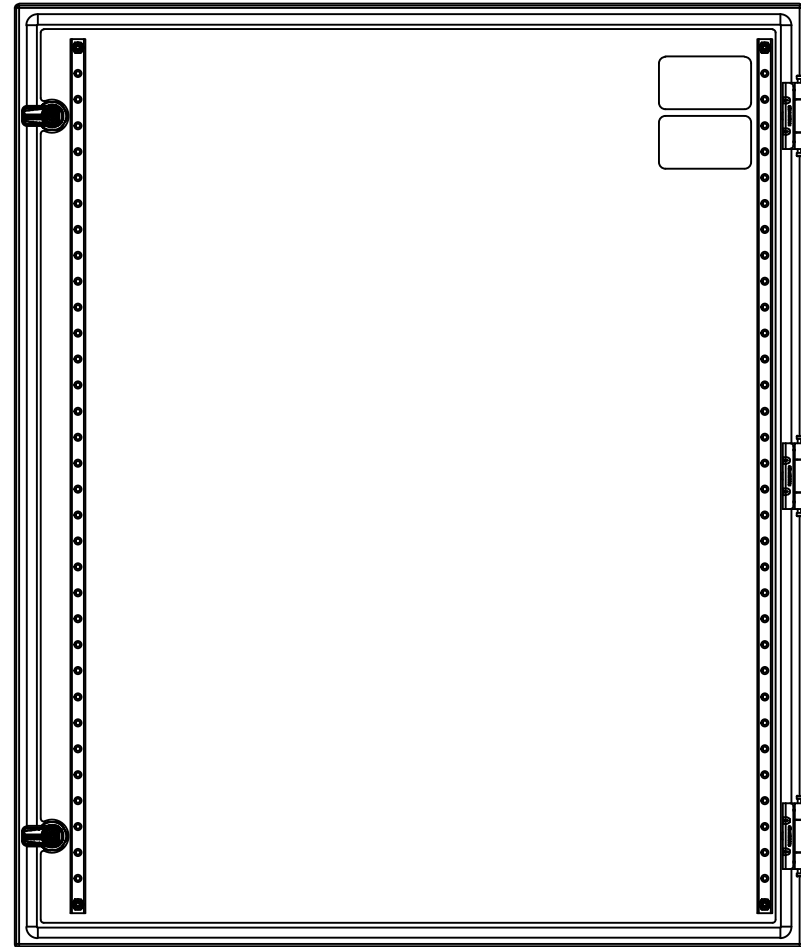

BACK

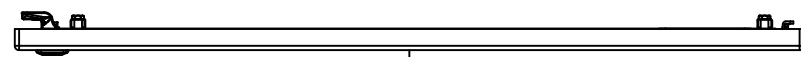

BOTTOM

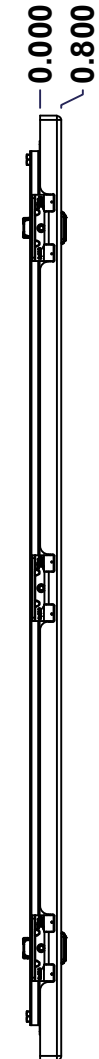

LEFT

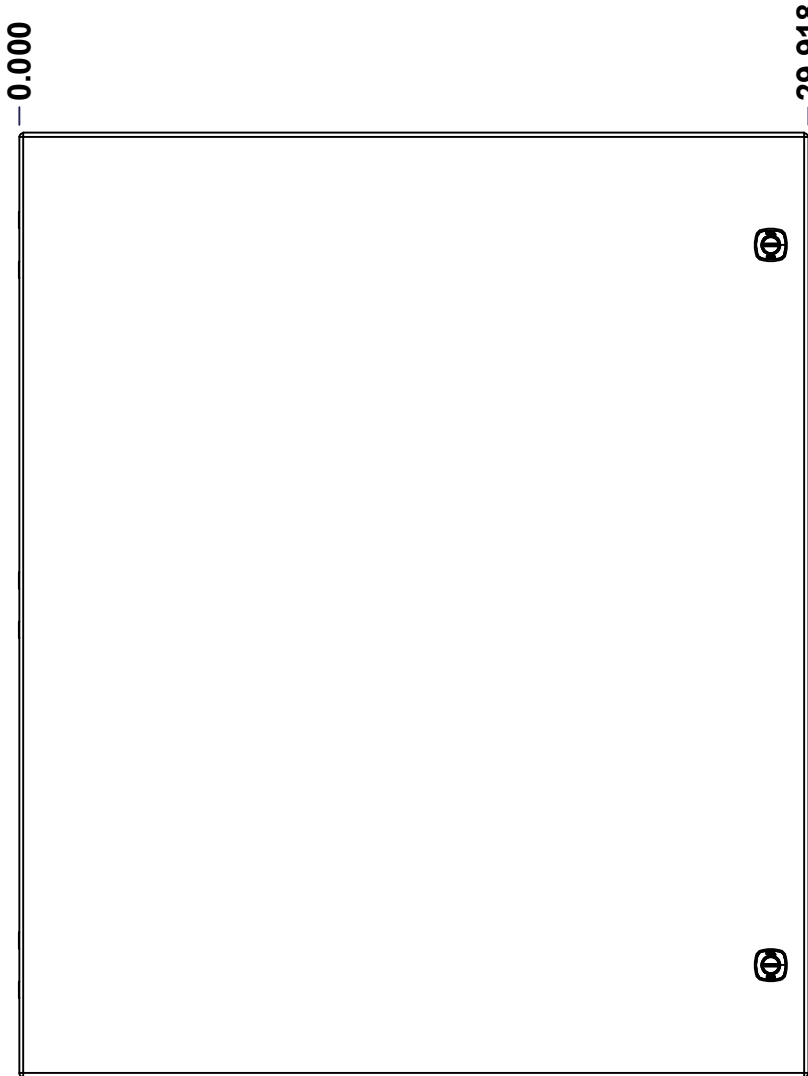

FRONT

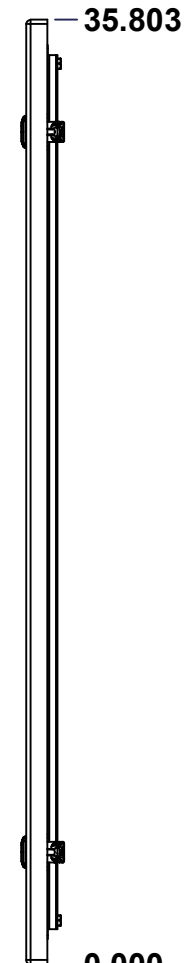

RIGHT

No.	Revisions	Date	By/Par

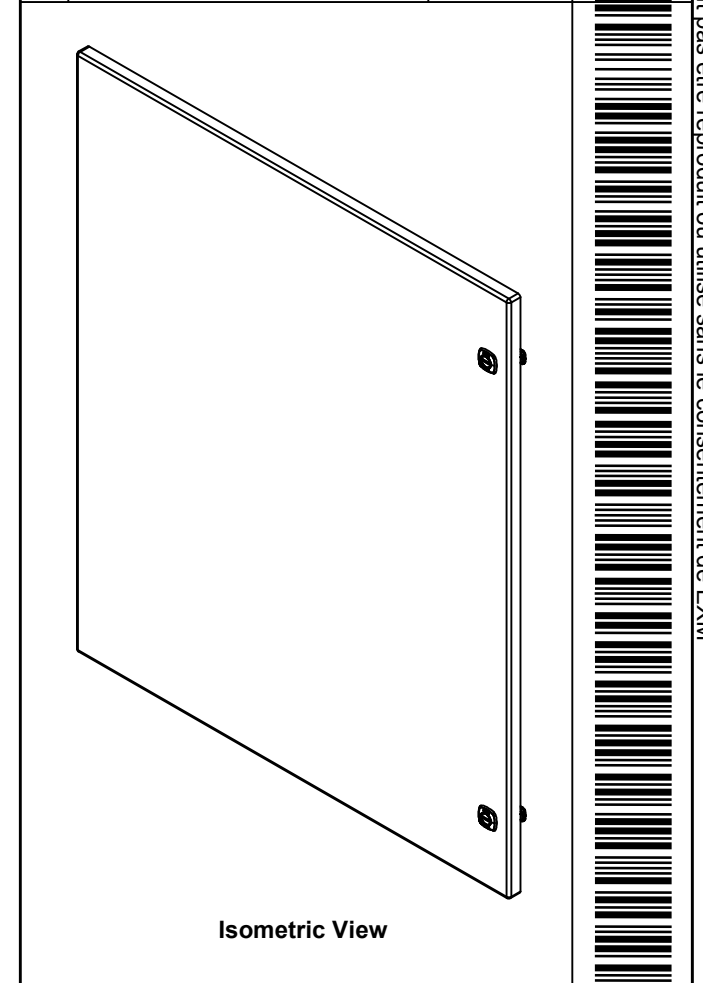

Isometric View



Tél: (450) 979-4373 Fax: (450) 979-4626 www.exmweb.com		Flatness Aplatissement Max 3.0mm Projection
Customer Client	Date	
Drawn By Dessiné Par	BoxCad: BoxCad	Date 26-May-23
Material Matière	14 Ga Stainless Steel 316 (1.7mm)	
Color Couleur	Unpainted	Finish Fini Brushed
Description	Detail Rev.	
5412ESS 36" x 30" Cover		
Part Number Numéro Pièce	Rev.	8
SEE BILL OF MATERIAL ON LAST PAGE 5412ESS3630066THNOIPC	0	16

SEE BILL OF MATERIAL ON LAST PAGE 5412ESS3630066THNOIPC

This drawing is confidential and must not be reproduced or used without the consent of EXM

Ce dessin est confidentiel et ne doit pas être reproduit ou utilisé sans le consentement de EXM

STANDARD FEATURES ARE NOT LISTED IN THIS HOLE TABLE			
HOLE TABLE - FRONT VIEW (CUSTOM FEATURE ONLY)			
CUT-OUT	XDIM	YDIM	DESCRIPTION
1	1.486	1.661	STUD M6 x 18mm (Inside)
2	1.486	34.142	STUD M6 x 18mm (Inside)
3	27.517	34.142	STUD M6 x 18mm (Inside)
4	27.517	1.661	STUD M6 x 18mm (Inside)

5	28.494	31.553	880 SCQ4-SLSS6
6	28.494	4.250	880 SCQ4-SLSS6

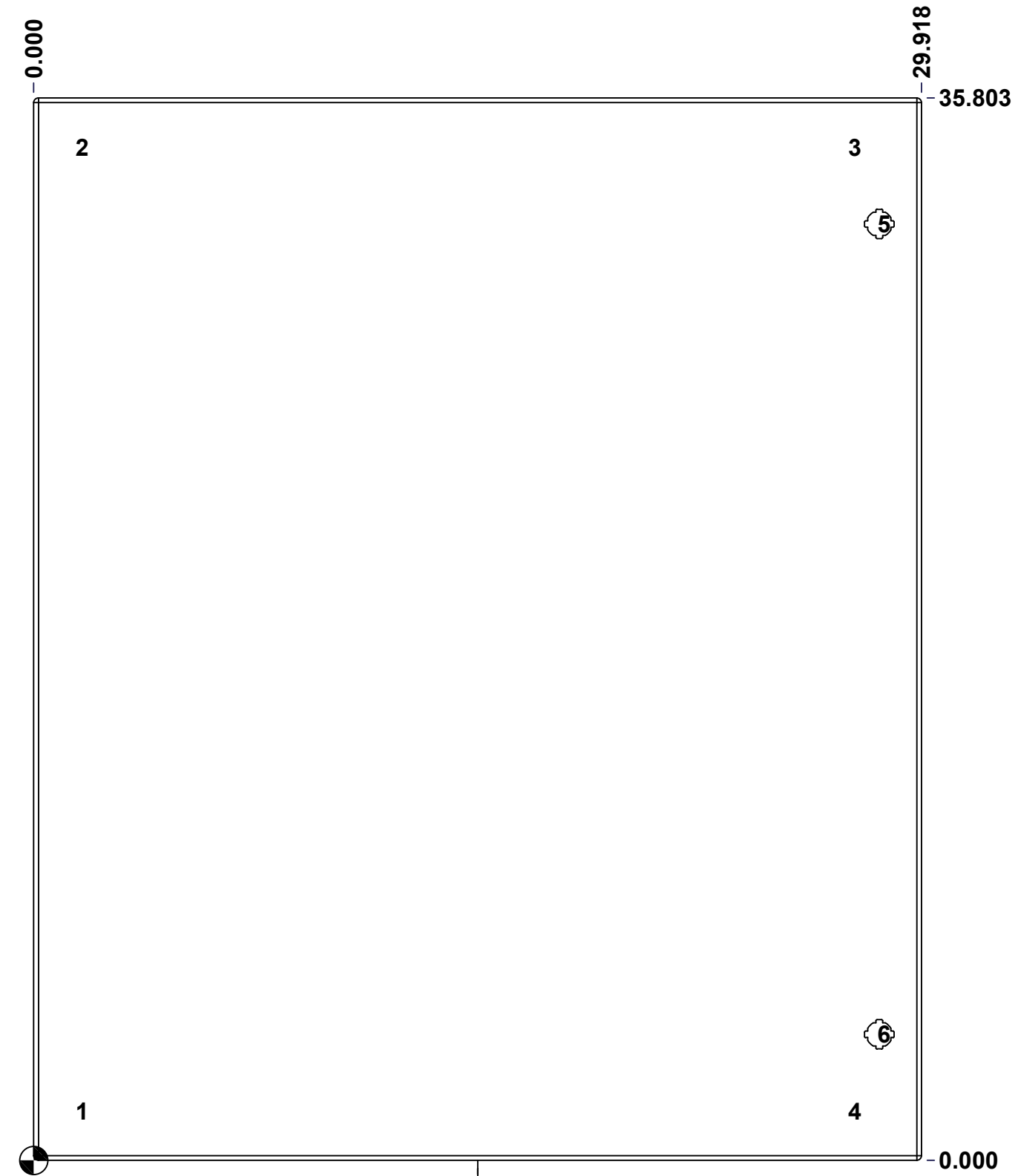

FRONT

	Description	Status
	5412ESS 36" x 30" Cover	(NULL)
	Part Number Numéro Pièce	Rev.
	5412ESS3630066THNOIPC	0
		9
		16

This drawing is confidential and must not be reproduced or used without the consent of EXM

Ce dessin est confidentiel et ne doit pas être reproduit ou utilisé sans le consentement de EXM

No.	Revisions	Date	By/Par

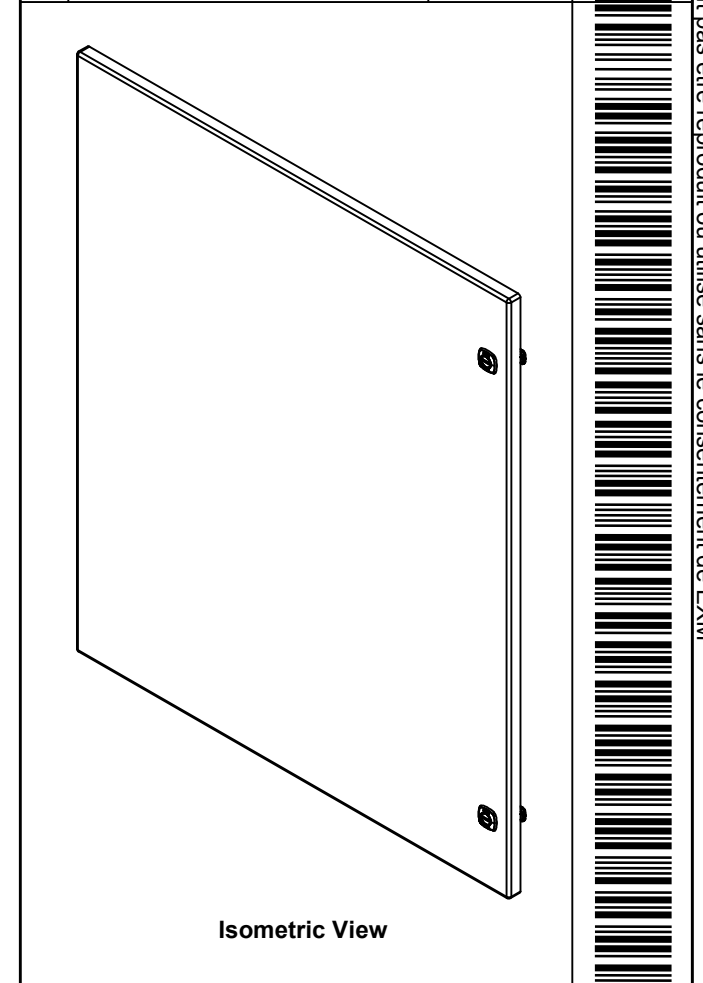

QTY	Part Number	Rev	Description
2	STK-S-00100	0	3.5" x 2" Silver Milar Flexcon Sticker
4	STK-Q-07250	2	M6 x 16mm Collar Nut
2	STK-Q-46020-36	5	5412 ES Vertical Door Stiffener 36"
1	5412ESS3630066THNOIP I-C	0	5412ESS 36" x 30" Cover Insulation
4	STK-Q-16070	1	Stud M6 x 18mm Stainless steel
1	5412ESS3630066THNOIP G	0	5412ESS 36" x 30" Cover Gasket Part
1	5412ESS3630066THNOIP C-P	0	5412ESS 36" x 30" Cover Part
2	880 SCQ4-SLSS6	7	5412 ESS 1/4 Turn Lock
3	STK-A-33016	0	5412 ESS Bended Hinge (Body Part)
Parts List			

Tél: (450) 979-4373
Fax: (450) 979-4626
www.exmweb.com

Flatness
Aplatissement
Max 3.0mm

Projection

Customer Client		Date
Drawn By Dessiné Par	BoxCad: BoxCad	Date 26-May-23
Material Matière 14 Ga Stainless Steel 316 (1.7mm)		
Color Couleur	Unpainted	Finish Fini Brushed
Description 5412ESS 36" x 30" Cover		Detail Rev.
Part Number Numéro Pièce 5412ESS3630066THNOIPC		Rev. 10 0 16

This drawing is confidential and must not be reproduced or used without the consent of EXM

Ce dessin est confidentiel et ne doit pas être reproduit ou utilisé sans le consentement de EXM

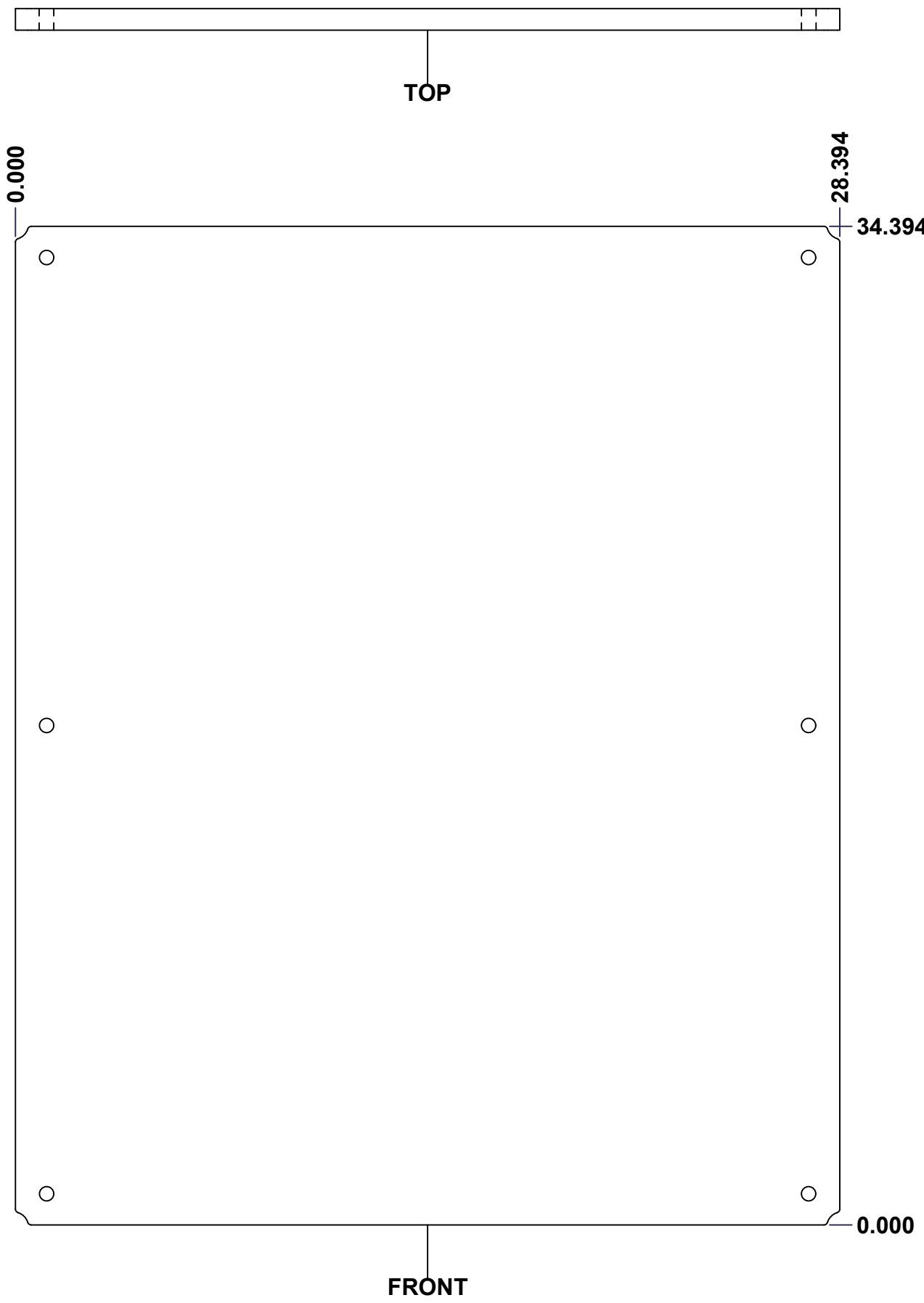

No.	Revisions	Date	By/Par

Isometric View

<p>Tél: (450) 979-4373 Fax: (450) 979-4626 www.exmweb.com</p>		Flatness Aplatissement
		Max 3.0mm
Projection		
Customer Client	Date	
Drawn By Dessiné Par	BoxCad: Patrick Deschenes	Date 23-Jan-07
Material Matière	Polyisocyanurate	
Color Couleur	Aluminum	Finish Fini N/A
Description	Detail Rev.	
5412ESS 36" x 30" Back Insulation		
Part Number Numéro Pièce	Rev.	11
SEE BILL OF MATERIAL ON LAST PAGE 5412ESS3630066THNOIP-B		0

This drawing is confidential and must not be reproduced or used without the consent of EXM

Ce dessin est confidentiel et ne doit pas être reproduit ou utilisé sans le consentement de EXM

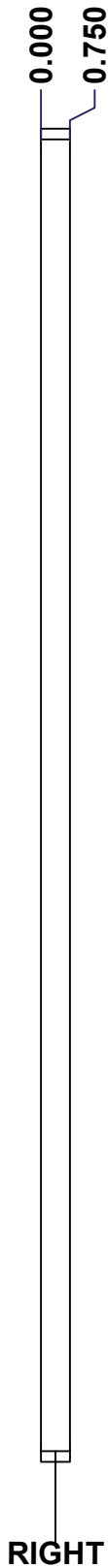
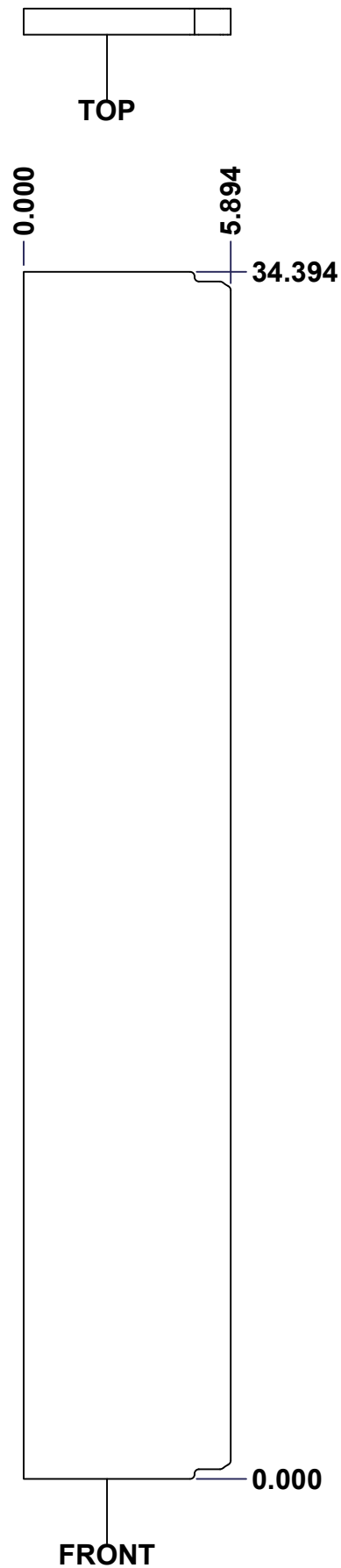

No.	Revisions	Date	By/Par



Isometric View

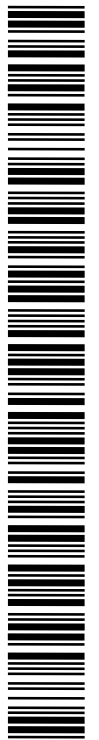

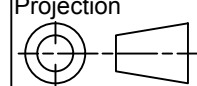
 Tél: (450) 979-4373 Fax: (450) 979-4626 www.exmweb.com		Flatness Aplatissement Max 3.0mm
Projection		
Customer Client	Date	
Drawn By Dessiné Par	BoxCad: Patrick Deschenes	Date 23-Jan-07
Material Matière	Polyisocyanurate	
Color Couleur	Aluminum	Finish Fini N/A
Description		Detail Rev.
5412ESS 36" x 30" Left Insulation		
Part Number Numéro Pièce	Rev.	12
SEE BILL OF MATERIAL ON LAST PAGE 5412ESS3630066THNOIPI-LS 0		16

This drawing is confidential and must not be reproduced or used without the consent of EXM

Ce dessin est confidentiel et ne doit pas être reproduit ou utilisé sans le consentement de EXM

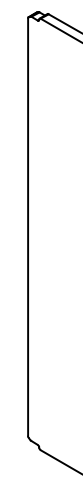
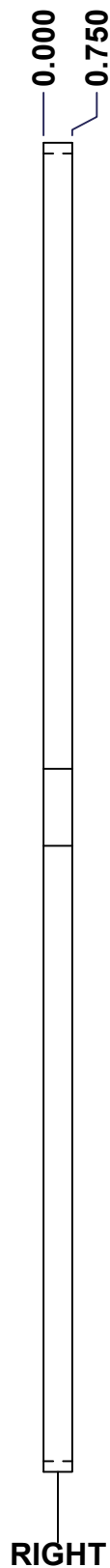
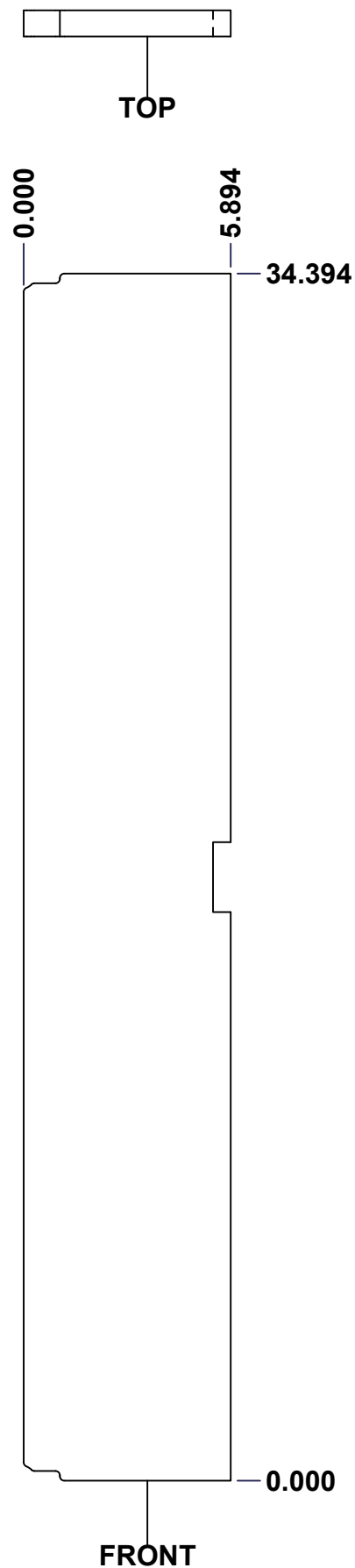

Isometric View



Tél: (450) 979-4373
 Fax: (450) 979-4626
www.exmweb.com

Flatness
Aplatissement

Max 3.0mm

Projection



Customer Client	Date
Drawn By Dessiné Par BoxCad: Patrick Deschenes	Date 23-Jan-07
Material Matière Polyisocyanurate	
Color Couleur Aluminum	Finish Fini N/A

Description 5412ESS 36" x 30" Right Insulation	Detail Rev.
---	-------------

Part Number Numéro Pièce	Rev. 13
-----------------------------	---------

SEE BILL OF MATERIAL ON LAST PAGE 5412ESS3630066THNOIPI-RS 0

This drawing is confidential and must not be reproduced or used without the consent of EXM

Ce dessin est confidentiel et ne doit pas être reproduit ou utilisé sans le consentement de EXM

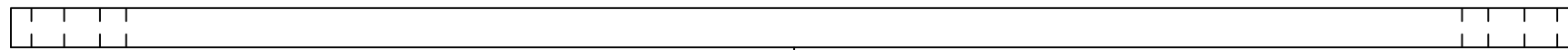

TOP

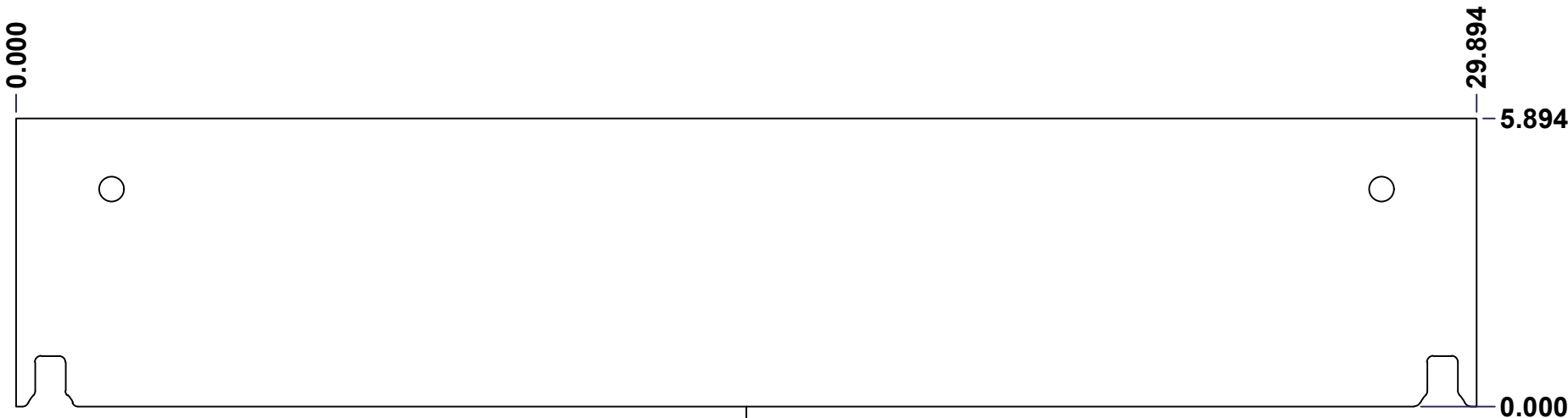

FRONT

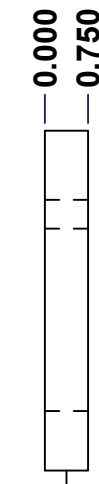

RIGHT

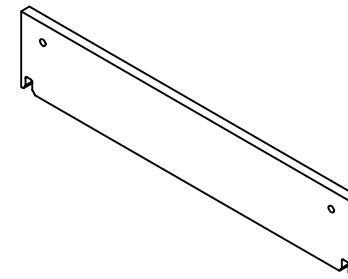

Isometric View



Tél: (450) 979-4373
Fax: (450) 979-4626
www.exmweb.com

Flatness
Aplatissement

Max 3.0mm

Projection

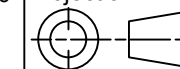

Customer Client	Date
Drawn By / Dessiné Par: BoxCad: Patrick Deschenes	Date: 23-Jan-07
Material / Matière: Polyisocyanurate	
Color / Couleur: Aluminum	Finish / Fini: N/A
Description: 5412ESS 36" x 30" Top and Bottom Insulation	Detail Rev.
Part Number / Numéro Pièce: 5412ESS3630066THNOIPI-TP 0	Rev. 14

SEE BILL OF MATERIAL ON LAST PAGE 5412ESS3630066THNOIPI-TP 0

This drawing is confidential and must not be reproduced or used without the consent of EXM

Ce dessin est confidentiel et ne doit pas être reproduit ou utilisé sans le consentement de EXM

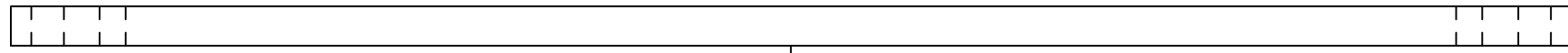

TOP

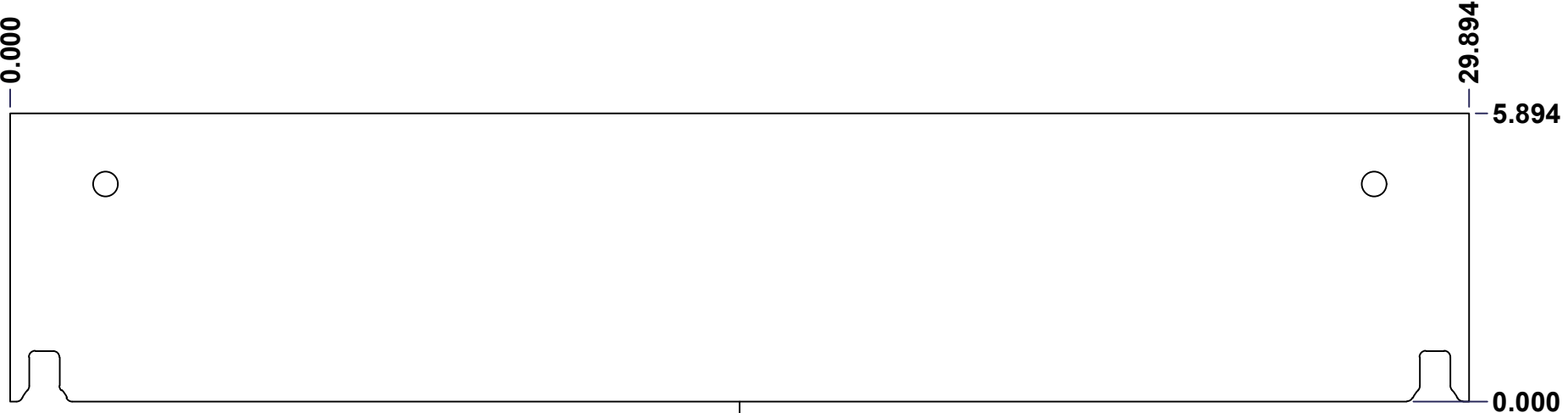

FRONT

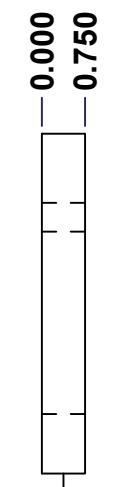

RIGHT

No.	Revisions	Date	By/Par

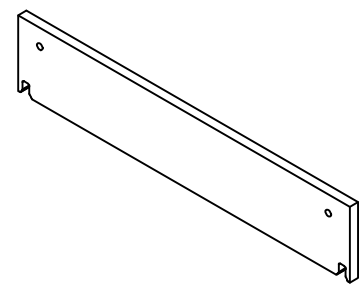

Isometric View

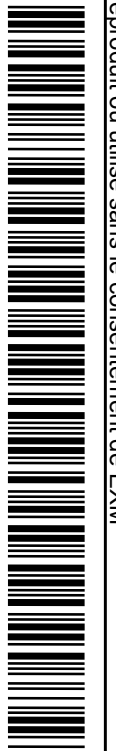

Tél: (450) 979-4373
 Fax: (450) 979-4626
www.exmweb.com

Flatness
Aplatissement
Max 3.0mm
Projection

Customer Client	Date
Drawn By / Dessiné Par: BoxCad: Patrick Deschenes	Date: 23-Jan-07
Material / Matière: Polyisocyanurate	
Color / Couleur: Aluminum	Finish / Fini: N/A
Description: 5412ESS 36" x 30" Top and Bottom Insulation	Detail Rev.

Part Number / Numéro Pièce	Rev.	15
----------------------------	------	----

SEE BILL OF MATERIAL ON LAST PAGE 5412ESS3630066THNOIPI-BT 0

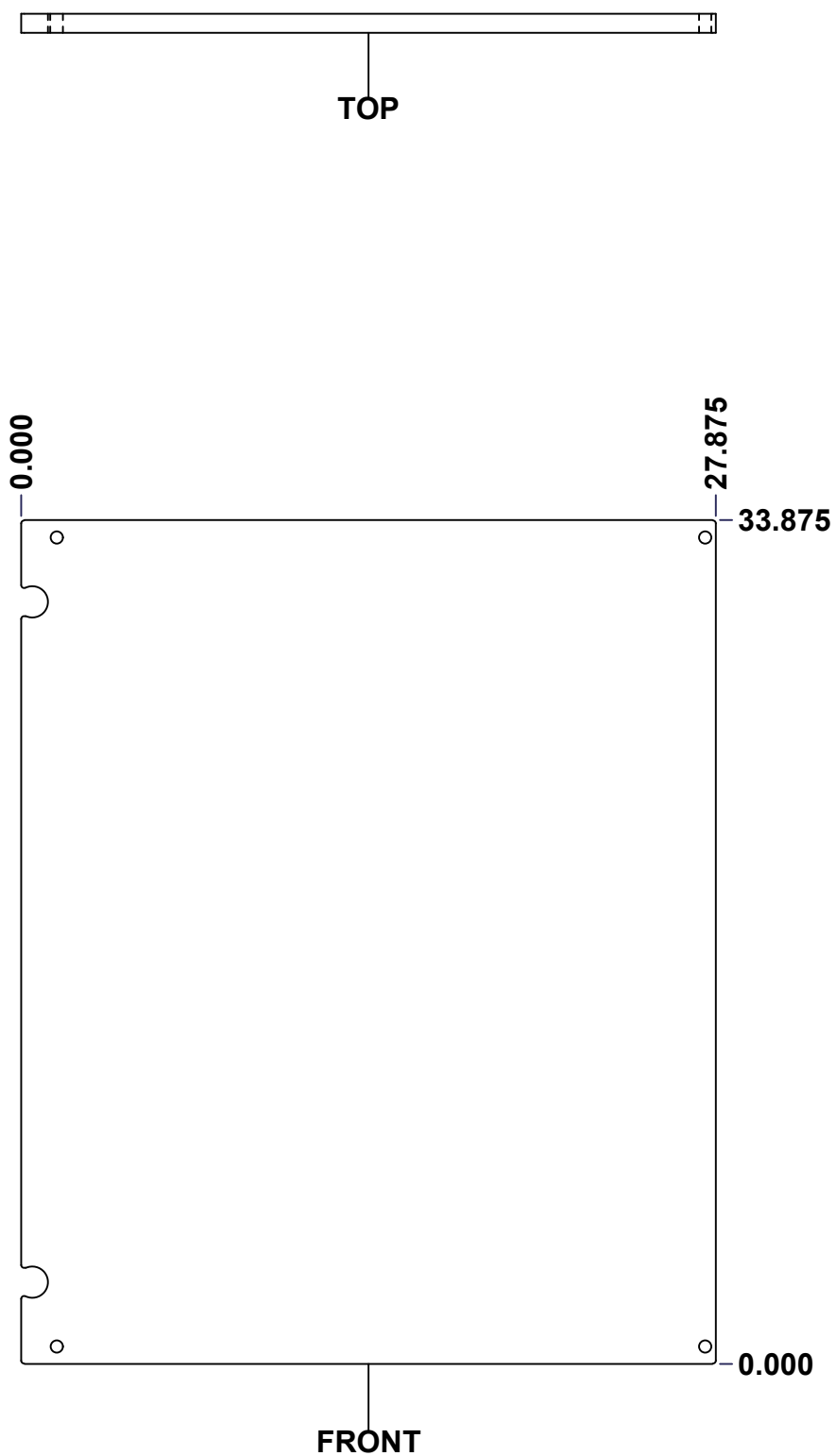

This drawing is confidential and must not be reproduced or used without the consent of EXM

Ce dessin est confidentiel et ne doit pas être reproduit ou utilisé sans le consentement de EXM

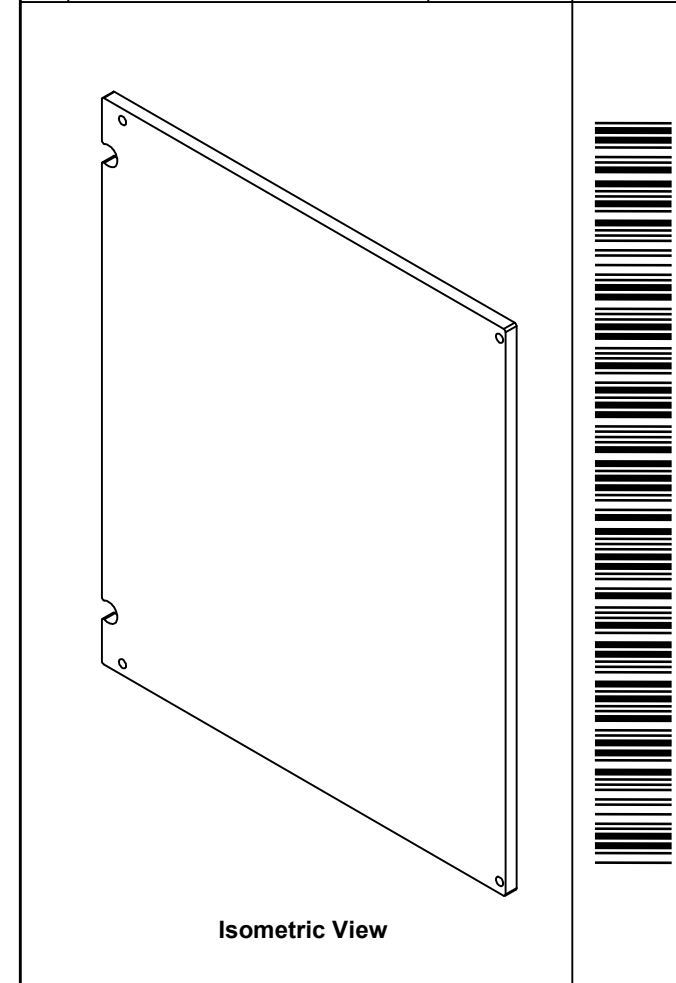

No.	Revisions	Date	By/Par



 Tél: (450) 979-4373 Fax: (450) 979-4626 www.exmweb.com		Flatness Aplatissement Max 3.0mm Projection 
Customer Client	Date	
Drawn By Dessiné Par	BoxCad: Patrick Deschenes	Date 23-Jan-07
Material Matière	Polyisocyanurate	
Color Couleur	Aluminum	Finish Fini N/A
Description	Detail Rev.	
5412ESS 36" x 30" Cover Insulation		
Part Number Numéro Pièce	Rev. 0	16

SEE BILL OF MATERIAL ON LAST PAGE 5412ESS3630066THNOIP-C 0 16