

This drawing is confidential and must not be reproduced or used without the consent of EXM

Ce dessin est confidentiel et ne doit pas être reproduit ou utilisé sans le consentement de EXM

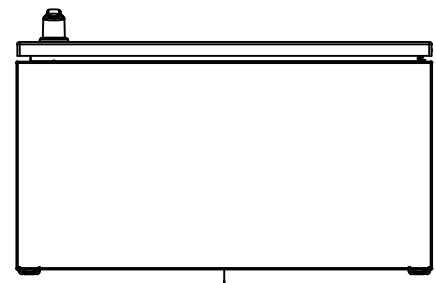

TOP

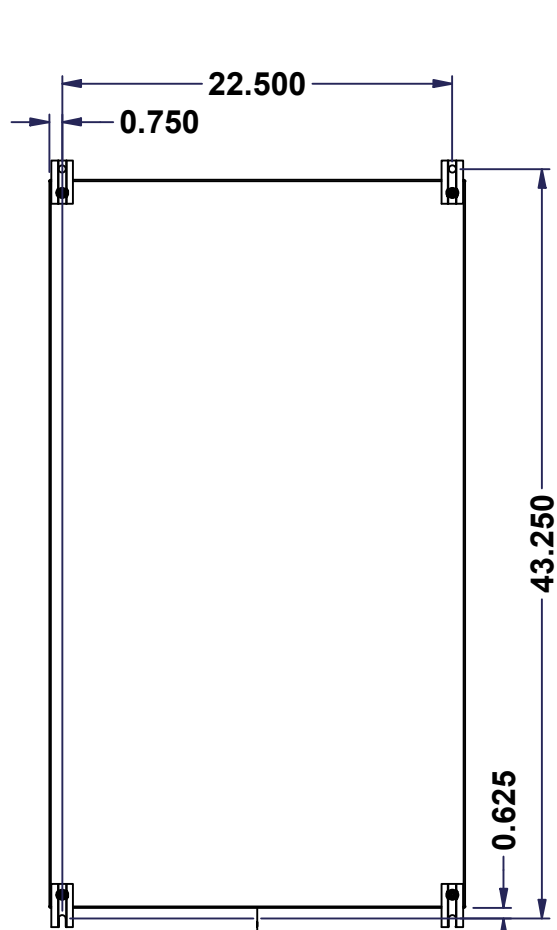

BACK

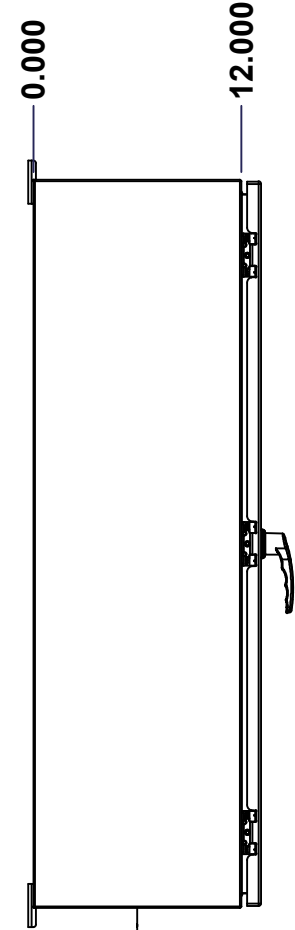

LEFT

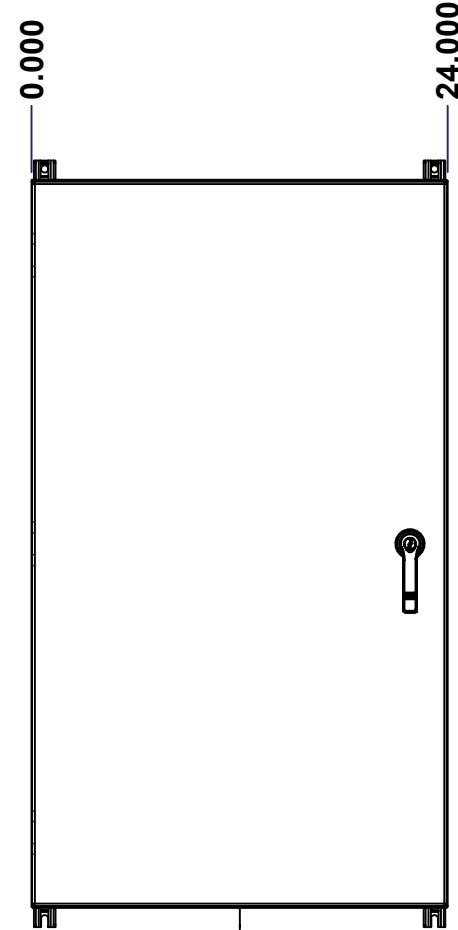

FRONT

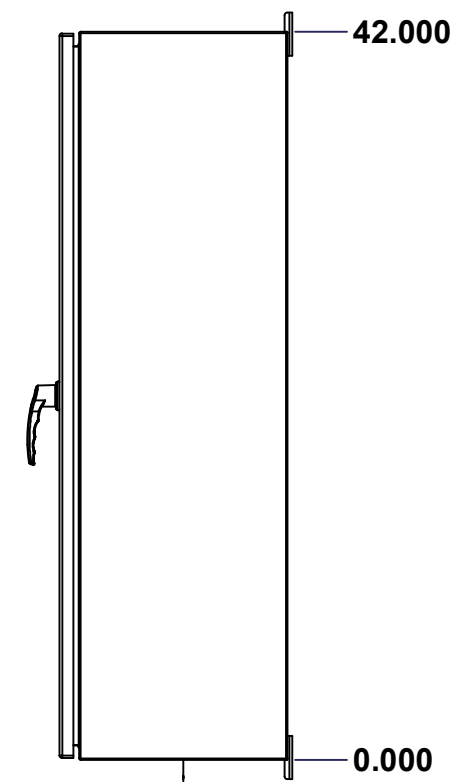

RIGHT

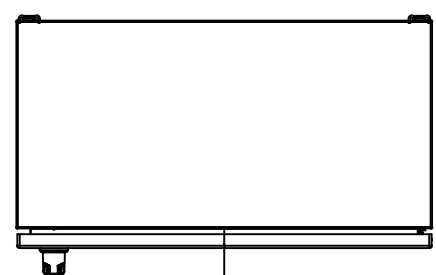

BOTTOM

No.	Revisions	Date	By/Par

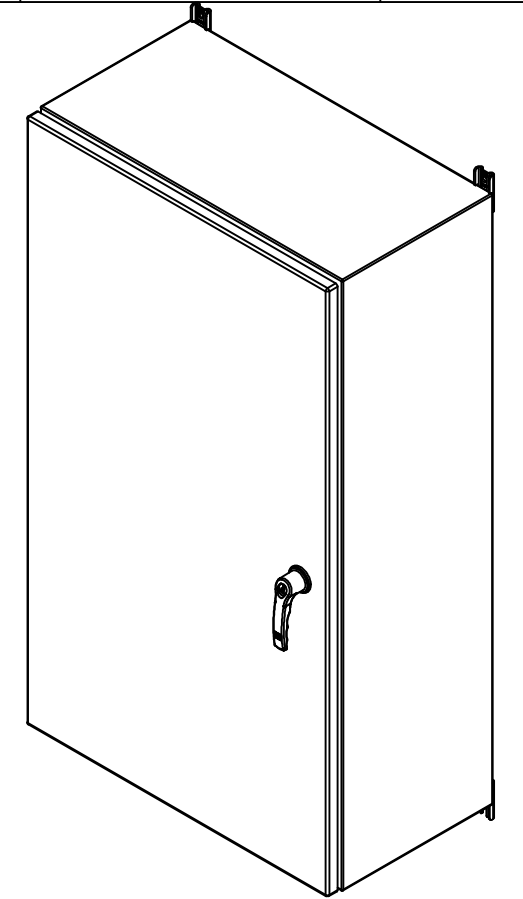

Isometric View



**GRAIN DIRECTION:
TOP/BOTTOM: HORIZONTAL
LEFT/RIGHT/BACK/FRONT: VERTICAL**

SEE BILL OF MATERIAL ON LAST PAGE

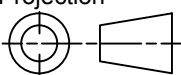
 Tél: (450) 979-4373 Fax: (450) 979-4626 www.exmweb.com		Flatness Aplatissement Max 3.0mm Projection 
Customer Client	Date	
Drawn By Dessiné Par	BoxCad: BoxCad	Date 24-May-23
Material Matière	16 Ga Stainless Steel 304 (1.4mm)	
Color Couleur	Unpainted	Finish Fini Brushed
Description	Detail Rev.	
5412ESS 42" x 24" x 12" Assembly		
Part Number Numéro Pièce	Rev.	1
5412ESS422412TH	0	16

This drawing is confidential and must not be reproduced or used without the consent of EXM

Ce dessin est confidentiel et ne doit pas être reproduit ou utilisé sans le consentement de EXM

NOTE	
ITEM	DESCRIPTION
1	NEMA 4X Enclosure
2	C/W Standard ground studs on box and cover
3	C/W Standard door stiffener
4	C/W Standard inner panel (Included)
5	C/W Standard inner panel mounting studs
6	C/W 885 ESMF4_OPEN Sold separately (Installed)
7	C/W 885 ESMF4_CLOSE Sold separately (Installed)
8	C/W R5 Insulation (Installed by EXM)

No.	Revisions	Date	By/Par

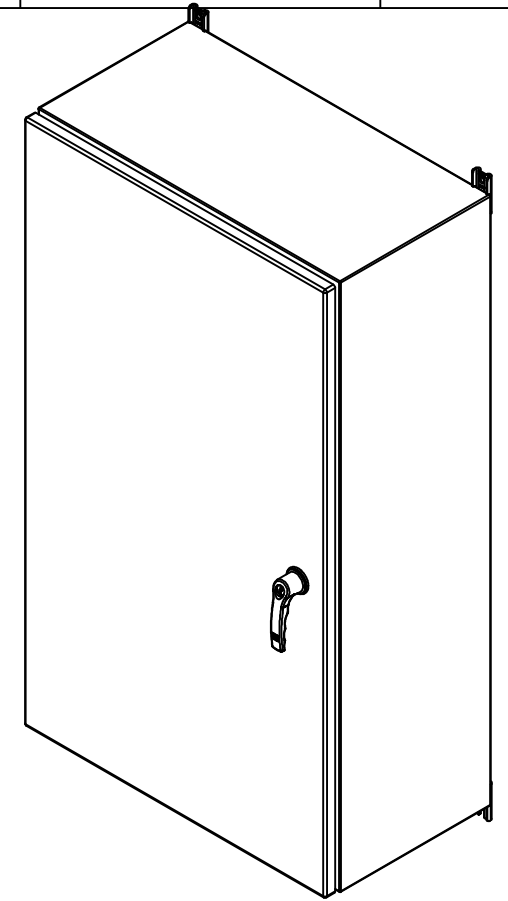

Isometric View



PACKING		
ITEM	QTY	DESCRIPTION
Cardboard sleeve	2	Top and Bottom
Cardboard strip	2	Between back of enclosure and inner panel
Plastic bag	1	To protect cover surface and inside gasket
Cardboard corner	4	To reinforced for the plastic strap tightening
Plastic strap - Black	2	To Squeeze the 2 cardboard sleeve together
Packaging label	3	White label with PN
Plastic strap- Green	2	To secure the enclosure to the wood pallet
Wood Pallet	1	2" deeper and 3" larger than enclosure size

6	STK-Q-00600	2	M12 to M8 Adaptor
1	881 SP4224G	0	881 SP - Inner Panel
1	STK-K-01800	5	5412 ES Accessory Kit
1	5412ESS422412THC	0	5412ESS 42" x 24" Cover
1	5412ESS422412THB	0	5412ESS 42" x 24" x 12" Body
3	STK-Q-04051-08	1	M6 x 8mm Stainless Steel Hexagon Socket Head Machine Screw with Nyseal
Qty	Part Number	Rev	Description
Parts List			

	Tél: (450) 979-4373 Fax: (450) 979-4626 www.exmweb.com	Flatness Aplatissement Max 3.0mm
	Projection 	Customer Client Date
Drawn By Dessiné Par	BoxCad: BoxCad	Date 24-May-23
Material Matière	16 Ga Stainless Steel 304 (1.4mm)	
Color Couleur	Unpainted	Finish Fini Brushed
Description 5412ESS 42" x 24" x 12" Assembly	Detail Rev.	
Part Number Numéro Pièce 5412ESS422412TH	Rev. 0	2 16

This drawing is confidential and must not be reproduced or used without the consent of EXM

Ce dessin est confidentiel et ne doit pas être reproduit ou utilisé sans le consentement de EXM

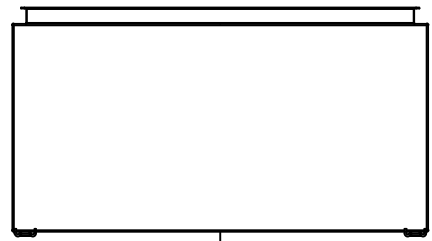

TOP

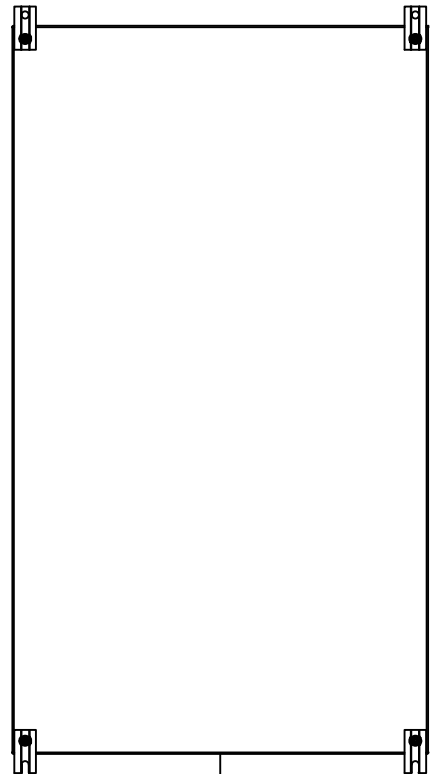

BACK

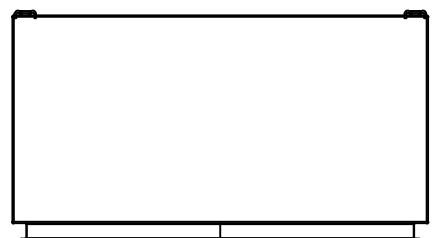

BOTTOM

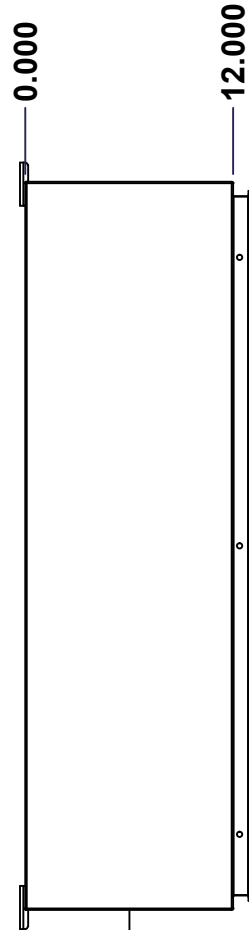

LEFT

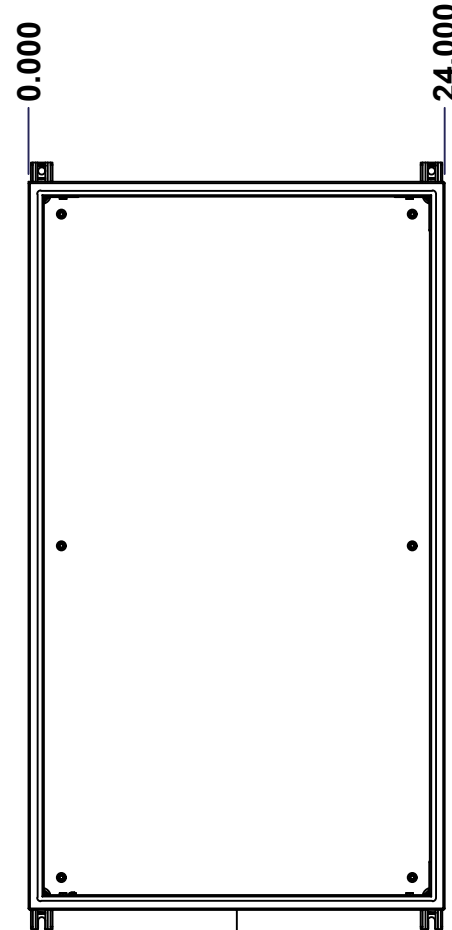

FRONT

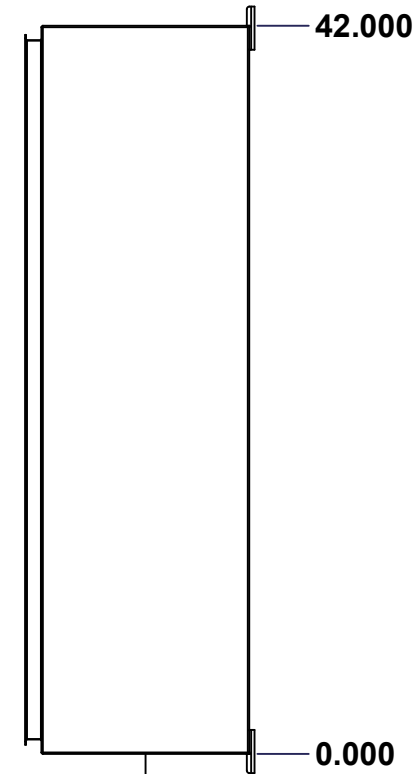

RIGHT

No.	Revisions	Date	By/Par

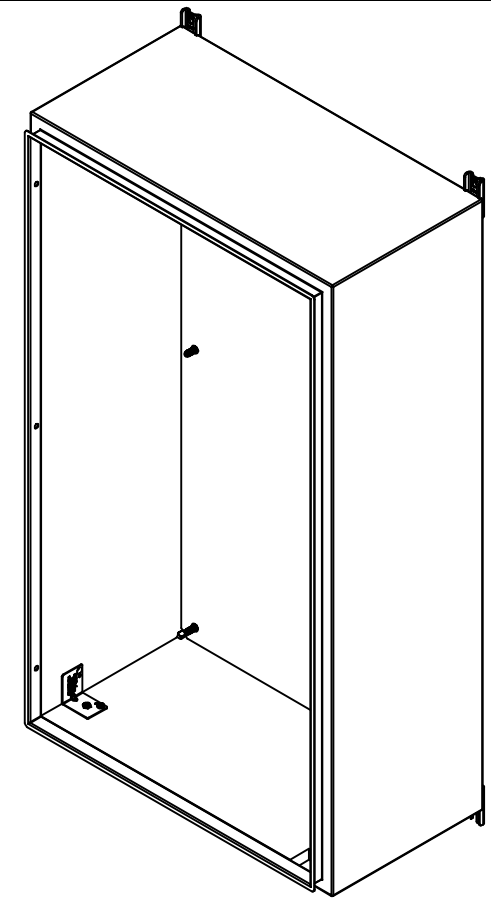

Isometric View



Tél: (450) 979-4373
 Fax: (450) 979-4626
www.exmweb.com

Flatness
Aplatissement

Max 3.0mm

Projection

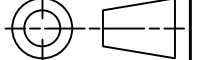

Customer Client	Date
Drawn By Dessiné Par BoxCad: BoxCad	Date 24-May-23
Material Matière 16 Ga Stainless Steel 304 (1.4mm)	
Color Couleur Unpainted	Finish Fini Brushed
Description 5412ESS 42" x 24" x 12" Body	Detail Rev.
Part Number Numéro Pièce 5412ESS422412THB	Rev. 3 0

SEE BILL OF MATERIAL ON LAST PAGE

This drawing is confidential and must not be reproduced or used without the consent of EXM

Ce dessin est confidentiel et ne doit pas être reproduit ou utilisé sans le consentement de EXM

STANDARD FEATURES ARE NOT LISTED IN THIS HOLE TABLE			
HOLE TABLE - TOP VIEW (CUSTOM FEATURE ONLY)			
CUT-OUT	XDIM	YDIM	DESCRIPTION
1	2.000	9.500	INSUL. STUD M6 x 18mm (Inside)
2	22.000	9.500	INSUL. STUD M6 x 18mm (Inside)

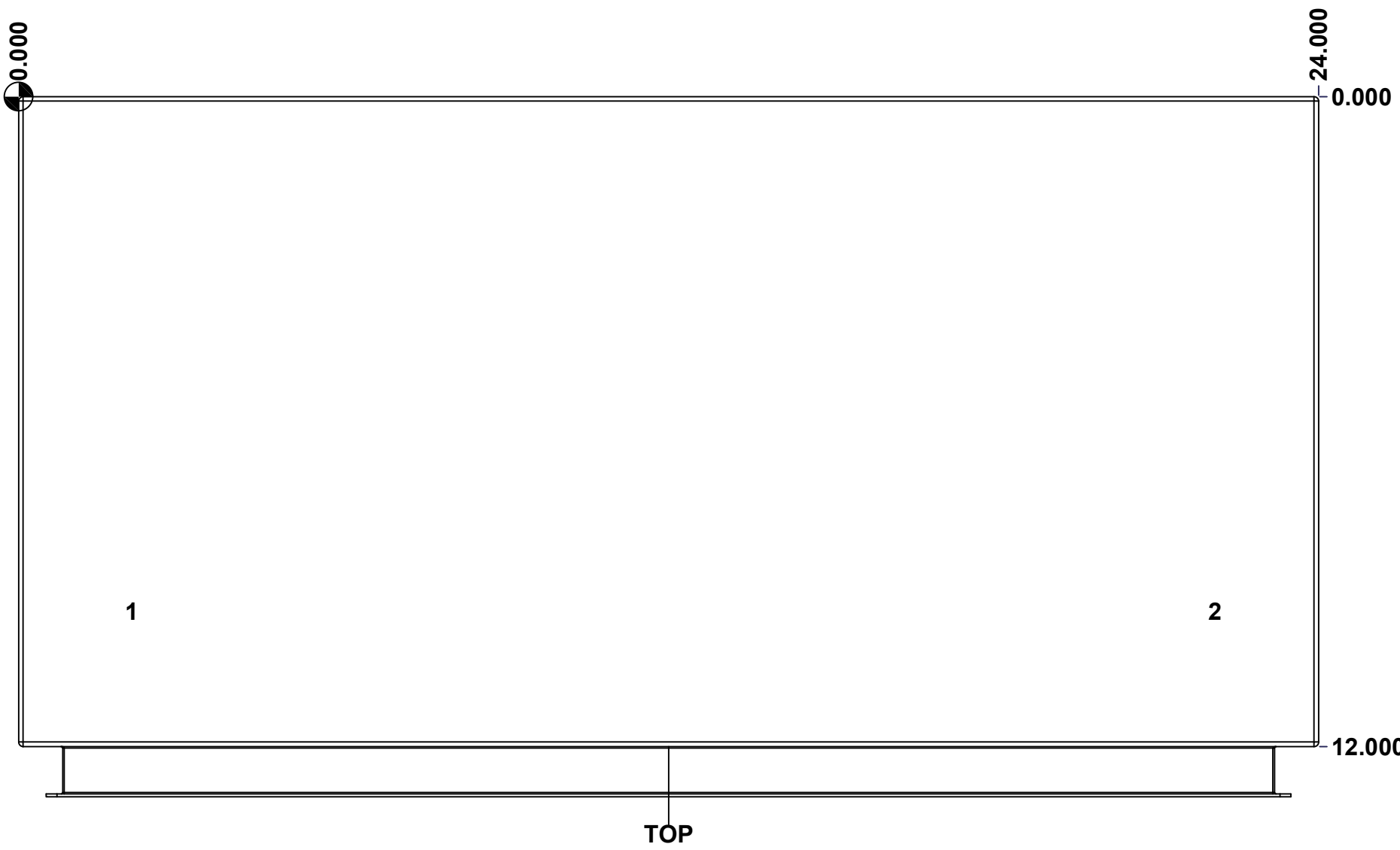

	Description	Status
	5412ESS 42" x 24" x 12" Body	(NULL)
	Part Number Numéro Pièce	Rev.
	5412ESS422412THB	0
		4
		16

This drawing is confidential and must not be reproduced or used without the consent of EXM

Ce dessin est confidentiel et ne doit pas être reproduit ou utilisé sans le consentement de EXM

STANDARD FEATURES ARE NOT LISTED IN THIS HOLE TABLE			
HOLE TABLE - BOTTOM VIEW (CUSTOM FEATURE ONLY)			
CUT-OUT	XDIM	YDIM	DESCRIPTION
1	2.000	9.500	INSUL. STUD M6 x 18mm (Inside)
2	22.000	9.500	INSUL. STUD M6 x 18mm (Inside)



	Description	Status
	5412ESS 42" x 24" x 12" Body	(NULL)
	Part Number Numéro Pièce	Rev.
	5412ESS422412THB	0 / 5
		16

This drawing is confidential and must not be reproduced or used without the consent of EXM

Ce dessin est confidentiel et ne doit pas être reproduit ou utilisé sans le consentement de EXM

STANDARD FEATURES ARE NOT LISTED IN THIS HOLE TABLE

HOLE TABLE - BACK VIEW (CUSTOM FEATURE ONLY)

CUT-OUT	XDIM	YDIM	DESCRIPTION
1	1.875	1.875	IP STUD M8 x 35mm (Inside)
2	1.875	40.125	IP STUD M8 x 35mm (Inside)
3	22.125	40.125	IP STUD M8 x 35mm (Inside)
4	22.125	1.875	IP STUD M8 x 35mm (Inside)
5	1.875	21.000	IP STUD M8 x 35mm (Inside)
6	22.125	21.000	IP STUD M8 x 35mm (Inside)

7	23.250	0.000	FOOT 885 ESMF4_OPEN
8	0.750	0.000	FOOT 885 ESMF4_OPEN
9	23.250	42.000	FOOT 885 ESMF4_CLOSE
10	0.750	42.000	FOOT 885 ESMF4_CLOSE

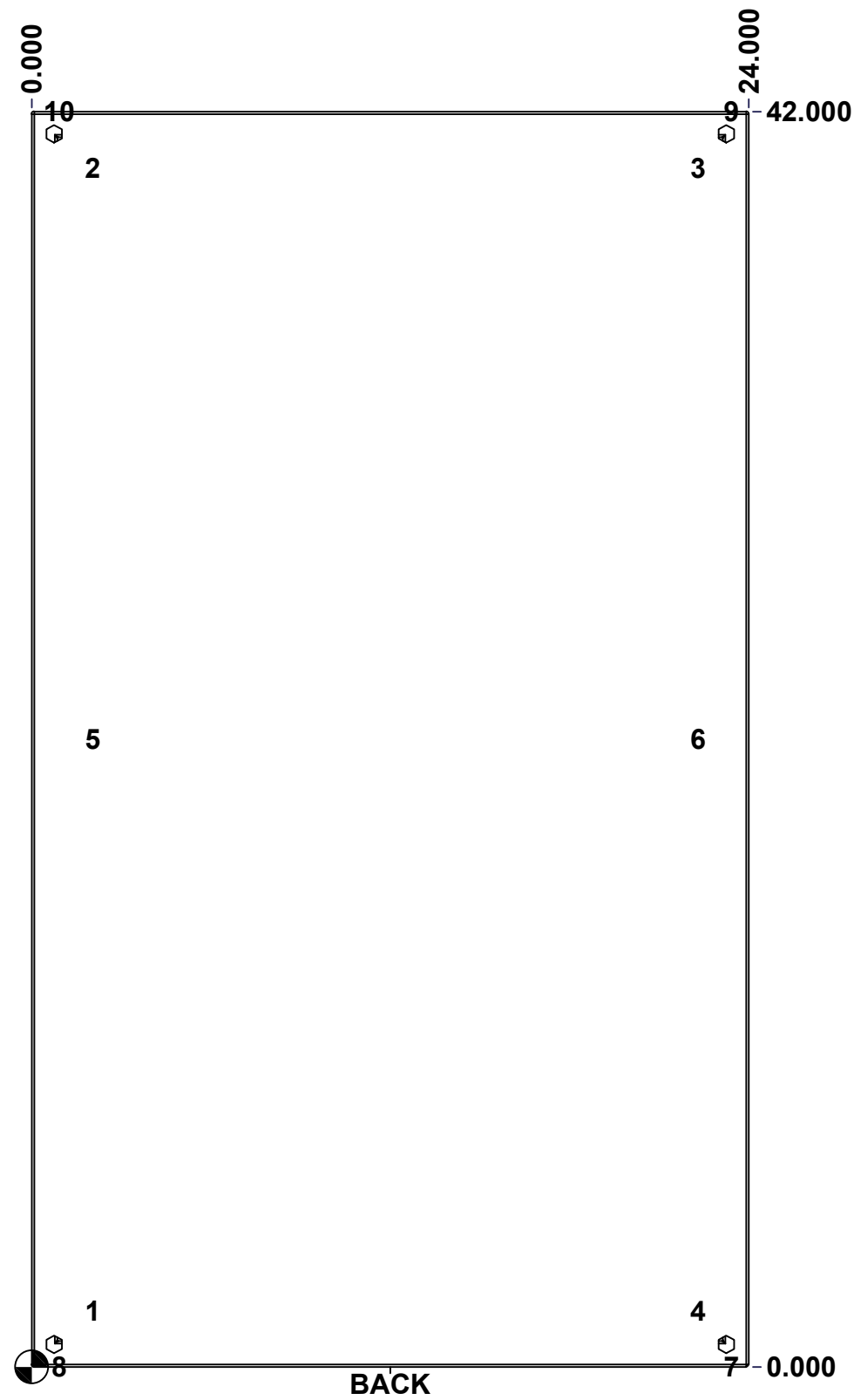

	Description	Status
	5412ESS 42" x 24" x 12" Body	(NULL)
	Part Number Numéro Pièce	Rev.
	5412ESS422412THB	0 / 6
		16

This drawing is confidential and must not be reproduced or used without the consent of EXM

Ce dessin est confidentiel et ne doit pas être reproduit ou utilisé sans le consentement de EXM

No.	Revisions	Date	By/Par

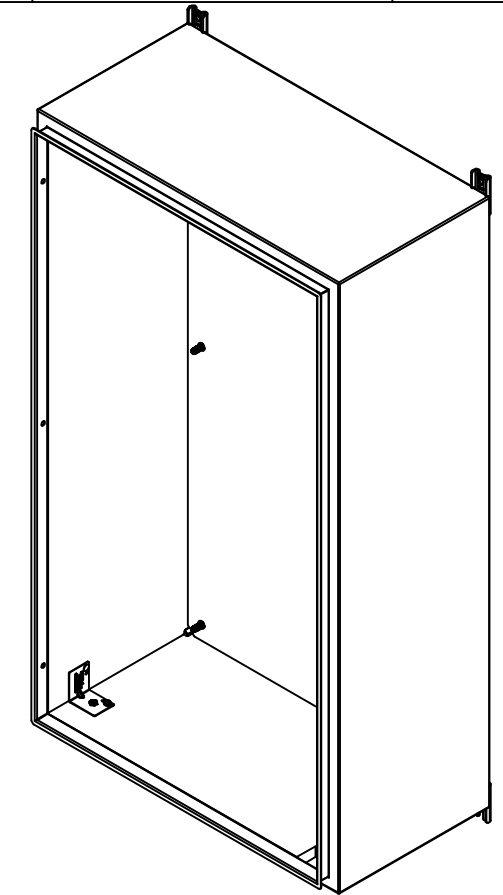

Isometric View



2	885ESMF4-FEET	0	885 ESMF4 Stainless Steel Mounting Foot
4	RIVET_NUT_SS_M10_FH_CE	0	Stainless Steel Rivet Nut M10 (Low Profile Close End)
4	STK-Q-06670	2	M10 x 16mm Stainless Steel Machine Screw
2	885ESMF4-FEET-A	0	885 ESMF4 Stainless Steel Mounting Foot (Opened Slot)
1	STK-K-70554	3	5412 ESTH Accessory Kit
1	5412ESS422412THI-RS	0	5412ESS 42" x 24" Right Insulation
1	5412ESS422412THI-LS	0	5412ESS 42" x 24" Left Insulation
1	5412ESS422412THI-BT	0	5412ESS 42" x 24" Top and Bottom Insulation
1	5412ESS422412THI-TP	0	5412ESS 42" x 24" Top and Bottom Insulation
1	5412ESS422412THI-B	0	5412ESS 42" x 24" Back Insulation
4	STK-Q-16070	1	Stud M6 x 18mm Stainless steel
6	STK-Q-16020	1	Stud M8 x 35mm Stainless Steel
1	5412ESS422412THB-P	0	5412ESS 42" x 24" x 12" Body Part

Qty	Part Number	Rev	Description
Parts List			

<p>Tél: (450) 979-4373 Fax: (450) 979-4626 www.exmweb.com</p>	Flatness Aplatissement	Max 3.0mm
	Projection	
Customer Client	Date	
Drawn By Dessiné Par	BoxCad: BoxCad	Date 24-May-23
Material Matière	16 Ga Stainless Steel 304 (1.4mm)	
Color Couleur	Unpainted	Finish Fini Brushed
Description	Detail Rev.	
5412ESS 42" x 24" x 12" Body		
Part Number Numéro Pièce	Rev.	7
5412ESS422412THB	0	16

This drawing is confidential and must not be reproduced or used without the consent of EXM

Ce dessin est confidentiel et ne doit pas être reproduit ou utilisé sans le consentement de EXM

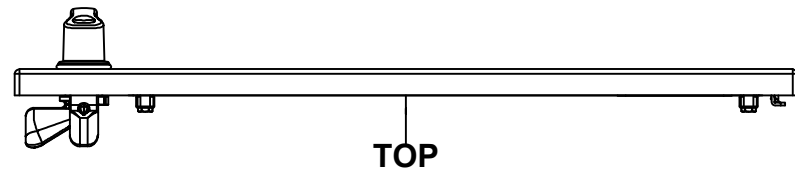

TOP

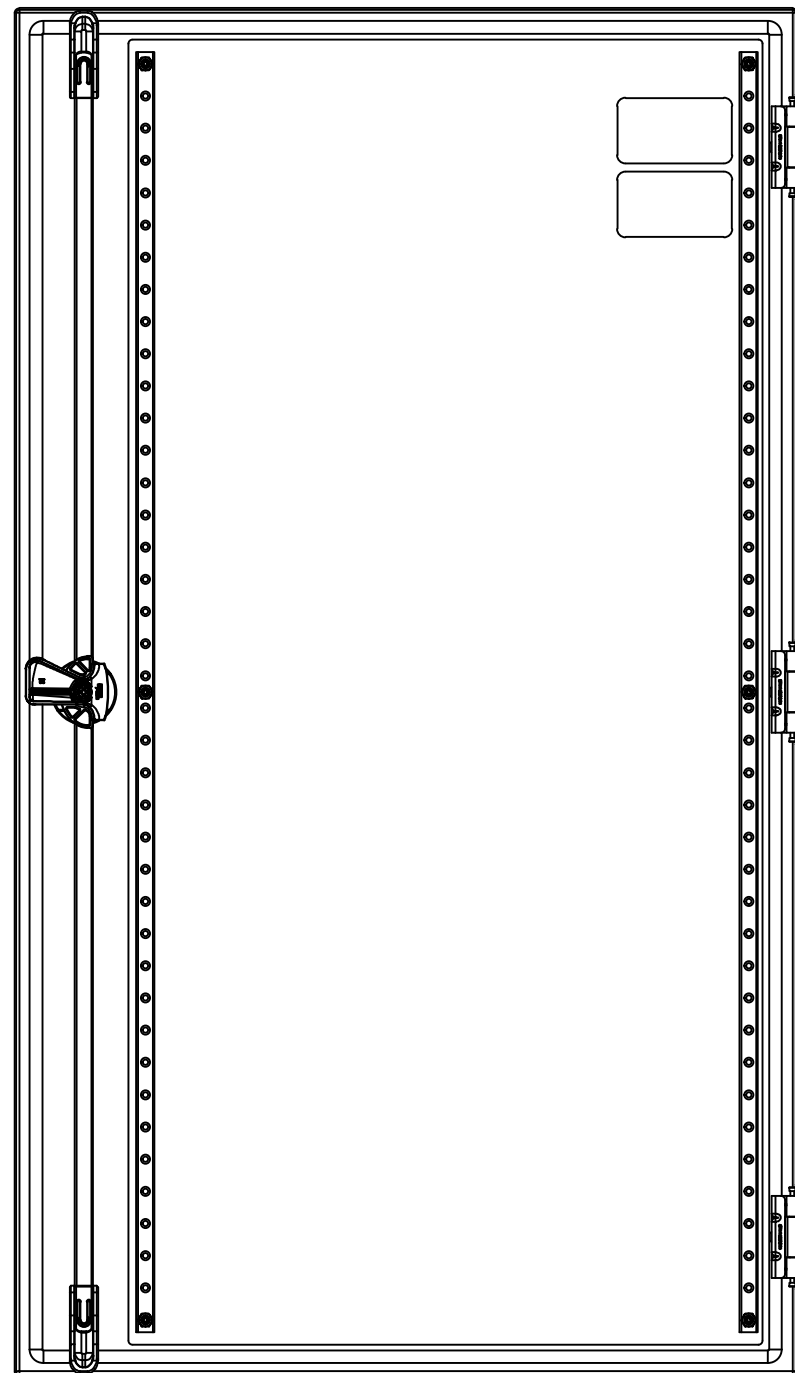

BACK

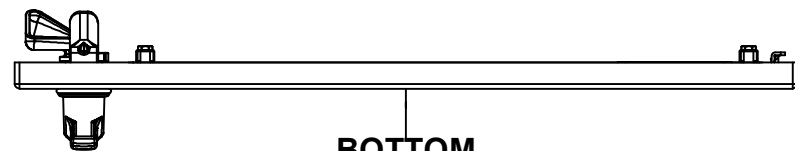

BOTTOM

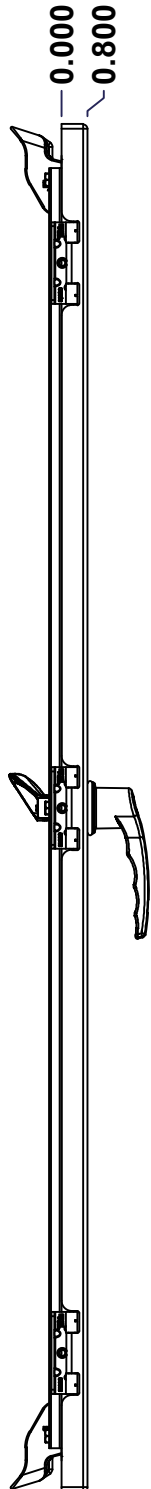

LEFT

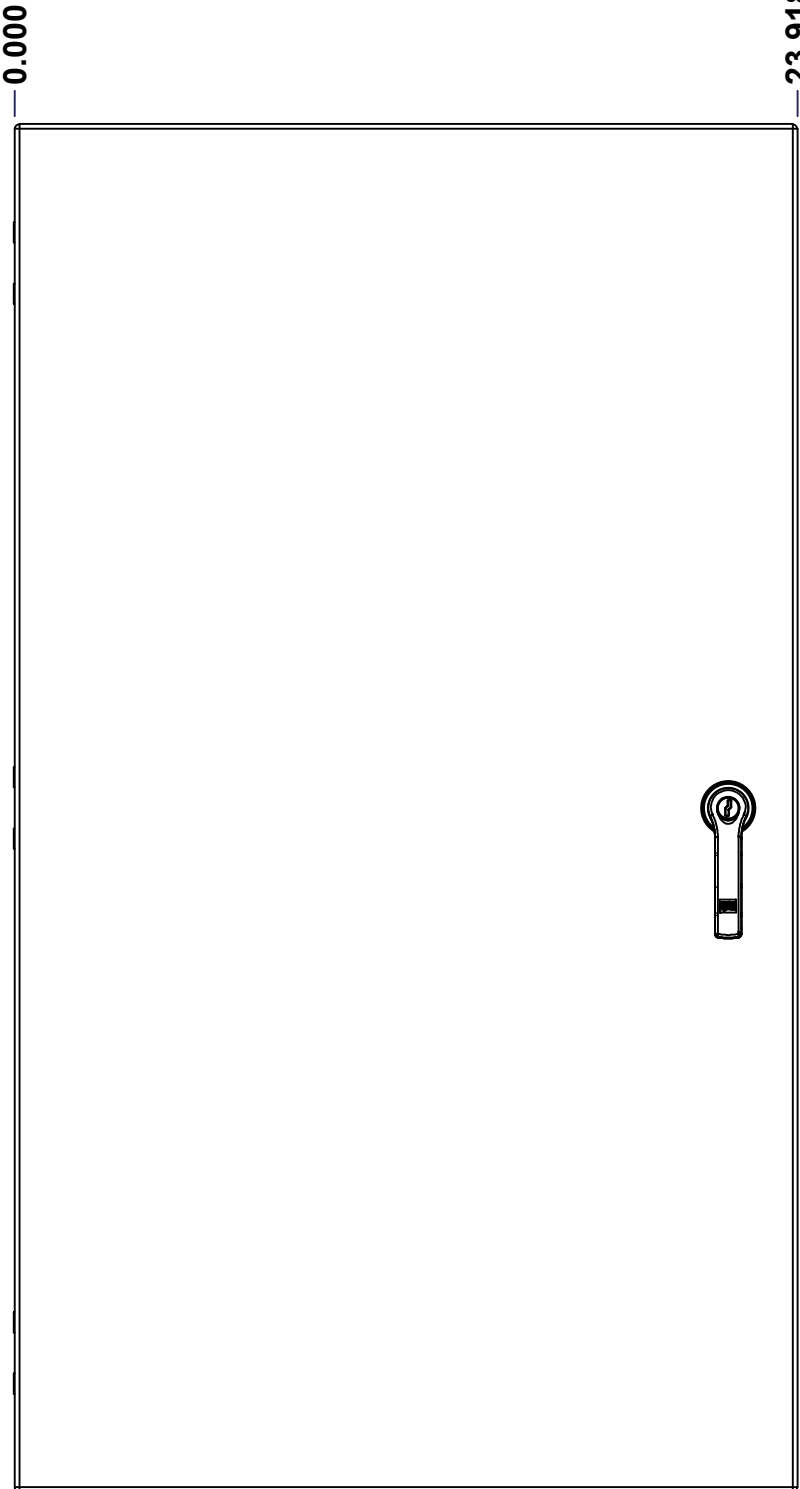

FRONT

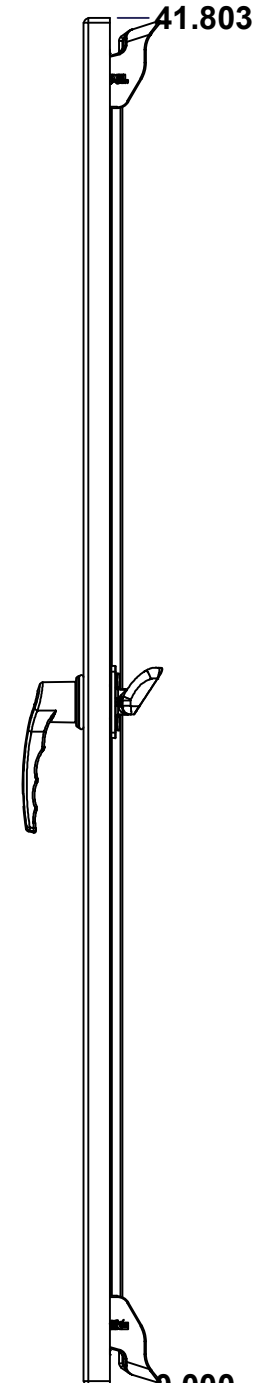

RIGHT

No.	Revisions	Date	By/Par

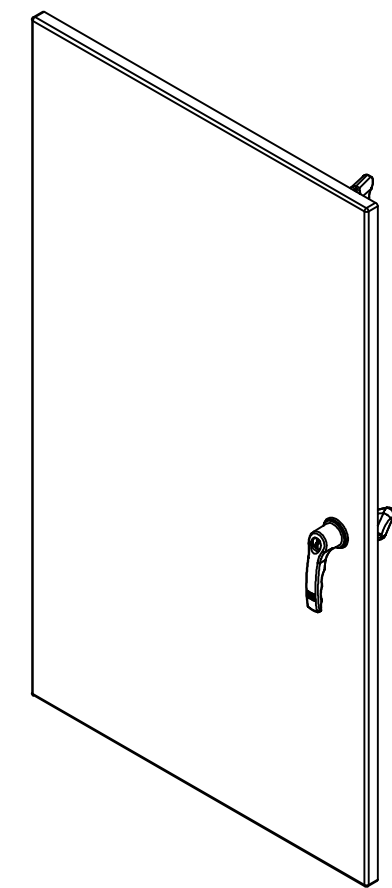

Isometric View

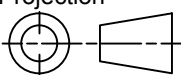

 Tél: (450) 979-4373 Fax: (450) 979-4626 www.exmweb.com		Flatness Aplatissement Max 3.0mm Projection 
Customer Client	Date	
Drawn By Dessiné Par	BoxCad: BoxCad	Date 24-May-23
Material Matière	16 Ga Stainless Steel 304 (1.4mm)	
Color Couleur	Unpainted	Finish Fini Brushed
Description	Detail Rev.	
5412ESS 42" x 24" Cover		
Part Number Numéro Pièce	Rev.	8
5412ESS422412THC	0	16

SEE BILL OF MATERIAL ON LAST PAGE

This drawing is confidential and must not be reproduced or used without the consent of EXM

Ce dessin est confidentiel et ne doit pas être reproduit ou utilisé sans le consentement de EXM

STANDARD FEATURES ARE NOT LISTED IN THIS HOLE TABLE			
HOLE TABLE - FRONT VIEW (CUSTOM FEATURE ONLY)			
CUT-OUT	XDIM	YDIM	DESCRIPTION
1	1.486	1.709	STUD M6 x 18mm (Inside)
2	1.486	40.094	STUD M6 x 18mm (Inside)
3	19.923	40.094	STUD M6 x 18mm (Inside)
4	19.923	1.709	STUD M6 x 18mm (Inside)
5	1.486	20.902	STUD M6 x 18mm (Inside)
6	19.923	20.902	STUD M6 x 18mm (Inside)
7	21.803	36.896	CLOSING BAR STUD (Inside)
8	21.803	4.907	CLOSING BAR STUD (Inside)
-----	-----	-----	-----
9	21.803	20.902	885 ESL2A-LSS

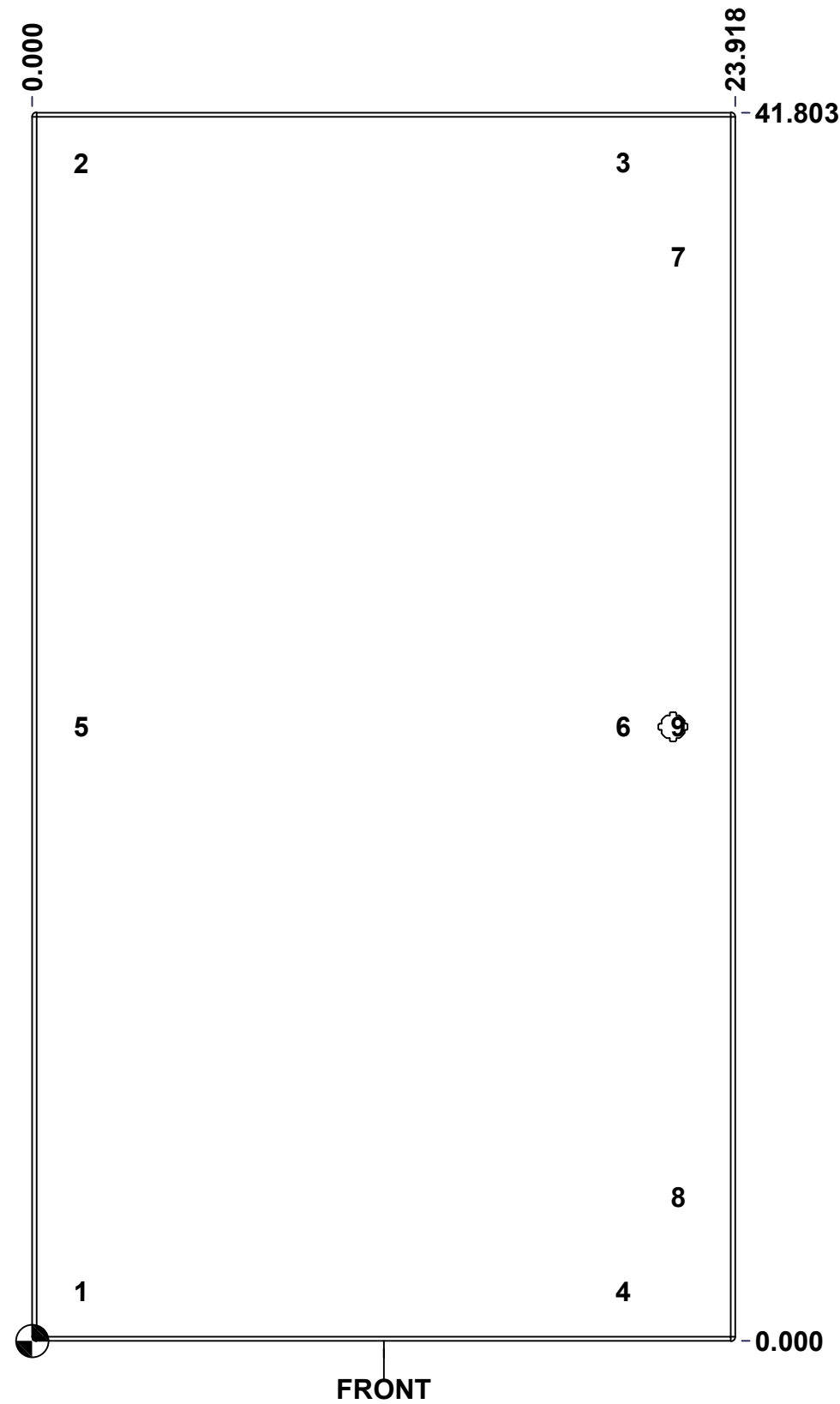

	Description	Status
	5412ESS 42" x 24" Cover	(NULL)
	Part Number Numéro Pièce	Rev.
	5412ESS422412THC	0
		9
		16

This drawing is confidential and must not be reproduced or used without the consent of EXM

Ce dessin est confidentiel et ne doit pas être reproduit ou utilisé sans le consentement de EXM

No.	Revisions	Date	By/Par

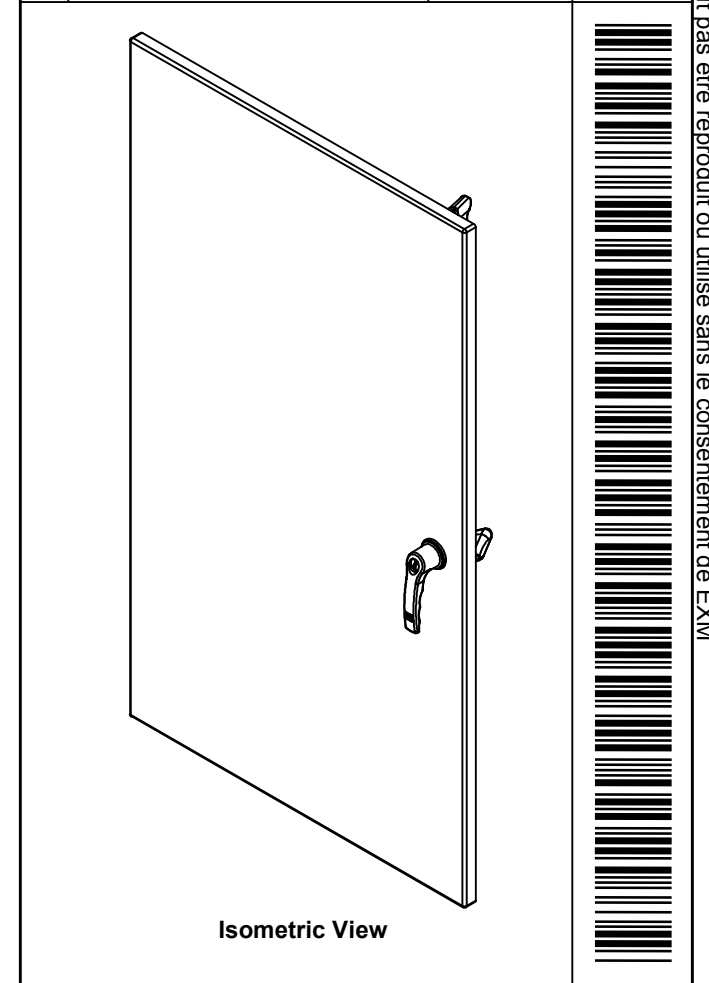

2	STK-Q-90042	4	5412 ES - Cabinet Closing Bar End (Small)
2	STK-Q-45655-42	0	5412 ES - Closing Bar
1	STK-Q-50536	13	5412 ES - Handle Cam Clockwise (Grip 32mm)
1	STK-Q-90051	3	5412 ES - Handle Cam Spacer
1	885 ESL2A-LSS	3	5412 ESS Key Lock L-Handle (3 Pts)
2	STK-S-00100	0	3.5" x 2" Silver Milar Flexcon Sticker
6	STK-Q-07250	2	M6 x 16mm Collar Nut
2	STK-Q-46020-42	5	5412 ES Vertical Door Stiffener 42"
1	5412ESS422412THI-C	0	5412ESS 42" x 24" Cover Insulation
2	STK-Q-16407	2	Guide Stud - Small (No Paint Cap Required)
6	STK-Q-16070	1	Stud M6 x 18mm Stainless steel
1	5412ESS422412THG	0	5412ESS 42" x 24" Cover Gasket Part
1	5412ESS422412THC-P	0	5412ESS 42" x 24" Cover Part
3	STK-A-33016	0	5412 ESS Bended Hinge (Body Part)
QTY	Part Number	Rev	Description
Parts List			

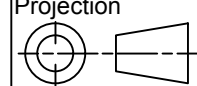
 Tél: (450) 979-4373 Fax: (450) 979-4626 www.exmweb.com	Flatness Aplatissement	Max 3.0mm
	Projection	
Customer Client	Date	
Drawn By Dessiné Par	BoxCad: BoxCad	Date 24-May-23
Material Matière	16 Ga Stainless Steel 304 (1.4mm)	
Color Couleur	Unpainted	Finish Fini Brushed
Description	Detail Rev.	
5412ESS 42" x 24" Cover		
Part Number Numéro Pièce	Rev.	10
5412ESS422412THC	0	16

This drawing is confidential and must not be reproduced or used without the consent of EXM

Ce dessin est confidentiel et ne doit pas être reproduit ou utilisé sans le consentement de EXM

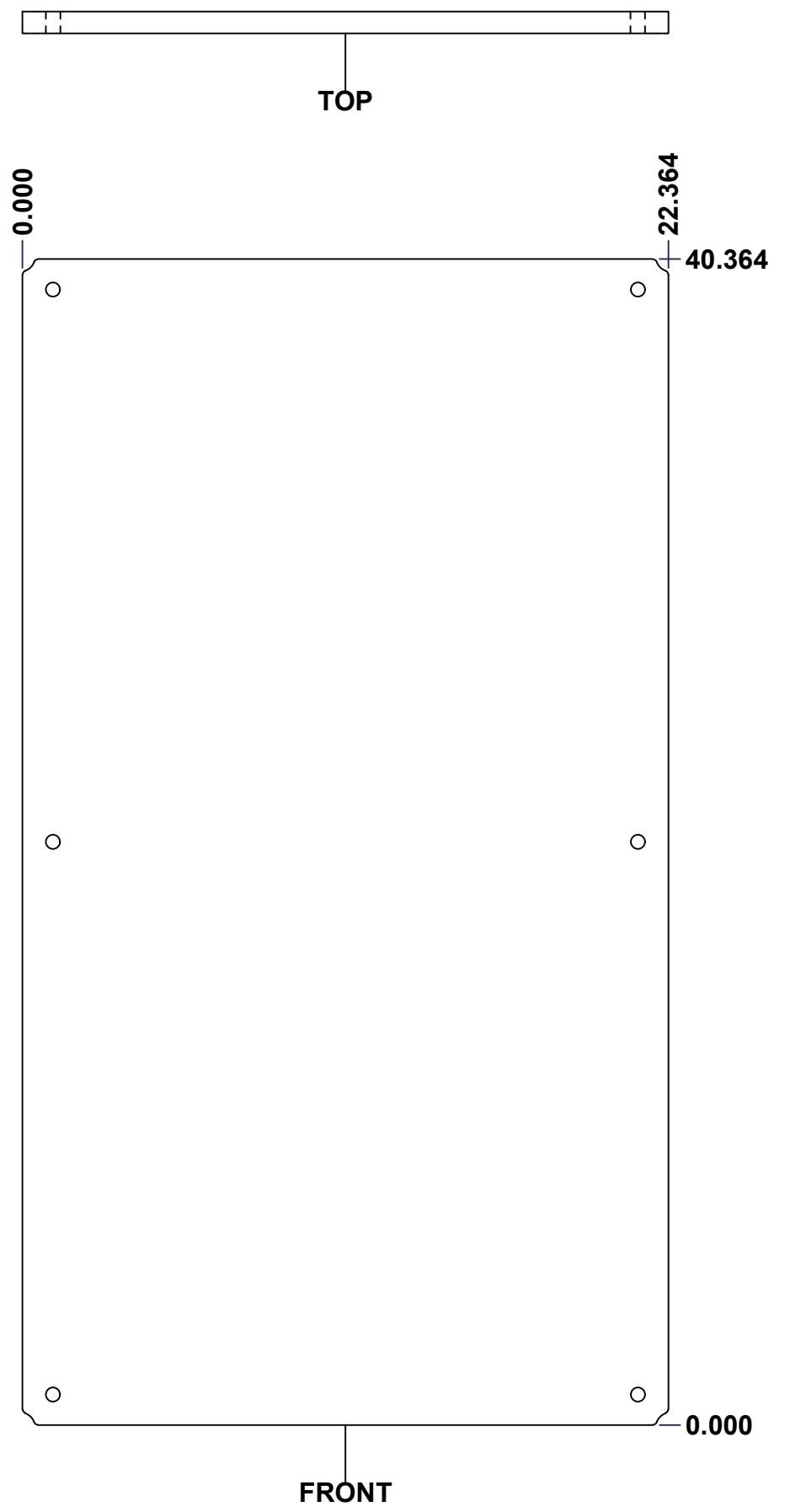

No.	Revisions	Date	By/Par

Isometric View

Tél: (450) 979-4373 Fax: (450) 979-4626 www.exmweb.com		Flatness Aplatissement	
		Max 3.0mm	
Customer Client		Date	
Drawn By Dessiné Par		BoxCad: Patrick Deschenes	Date 23-Jan-07
Material Matière: Polyisocyanurate			
Color Couleur: Aluminum		Finish Fini: N/A	
Description 5412ESS 42" x 24" Back Insulation			Detail Rev.
Part Number Numéro Pièce: 5412ESS422412THI-B		Rev. 0	11 / 16

SEE BILL OF MATERIAL ON LAST PAGE

This drawing is confidential and must not be reproduced or used without the consent of EXM

Ce dessin est confidentiel et ne doit pas être reproduit ou utilisé sans le consentement de EXM

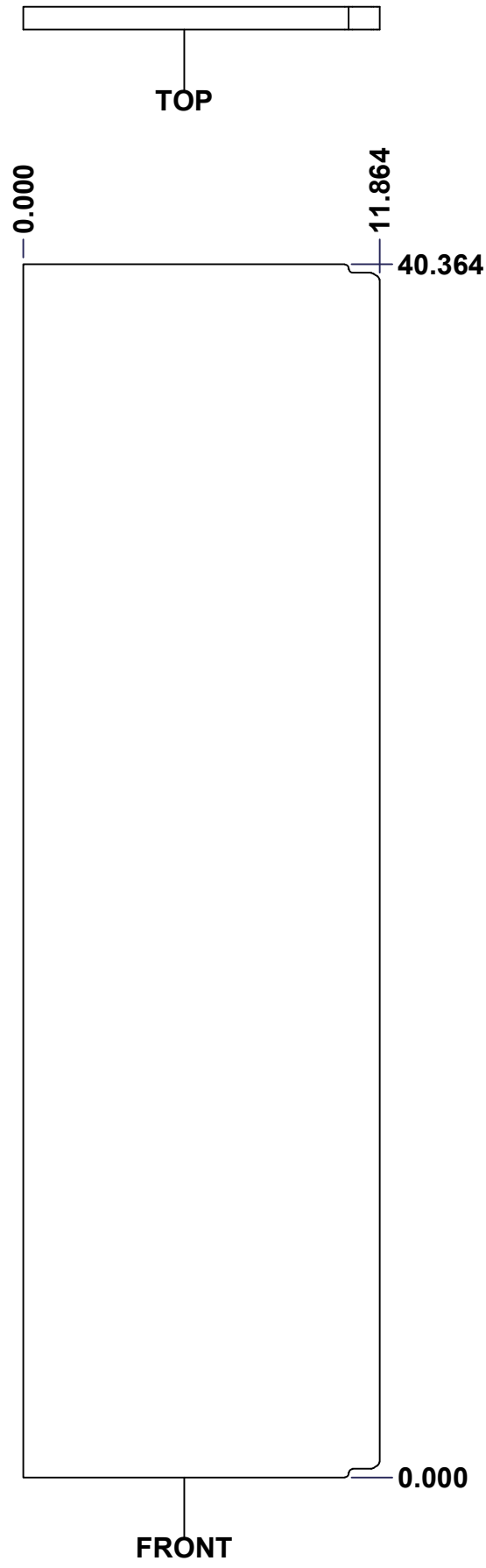

No.	Revisions	Date	By/Par

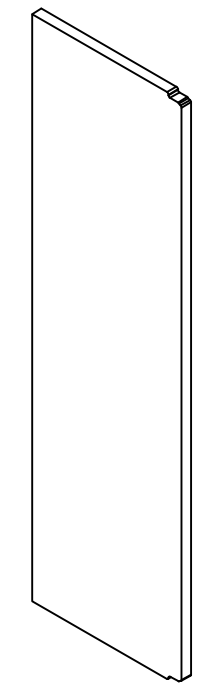

Isometric View

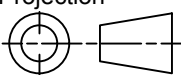

 Tél: (450) 979-4373 Fax: (450) 979-4626 www.exmweb.com	Flatness Aplatissement Max 3.0mm
	Projection 
Customer Client	Date
Drawn By Dessiné Par BoxCad: Patrick Deschenes	Date 23-Jan-07
Material Matière Polyisocyanurate	
Color Couleur Aluminum	Finish Fini N/A
Description 5412ESS 42" x 24" Left Insulation	
Detail Rev.	
Part Number Numéro Pièce 5412ESS422412THI-LS	Rev. 12 0 16

SEE BILL OF MATERIAL ON LAST PAGE

This drawing is confidential and must not be reproduced or used without the consent of EXM

Ce dessin est confidentiel et ne doit pas être reproduit ou utilisé sans le consentement de EXM

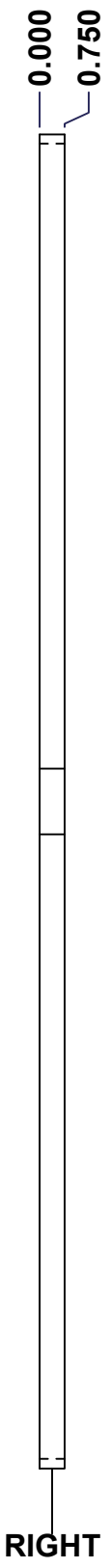
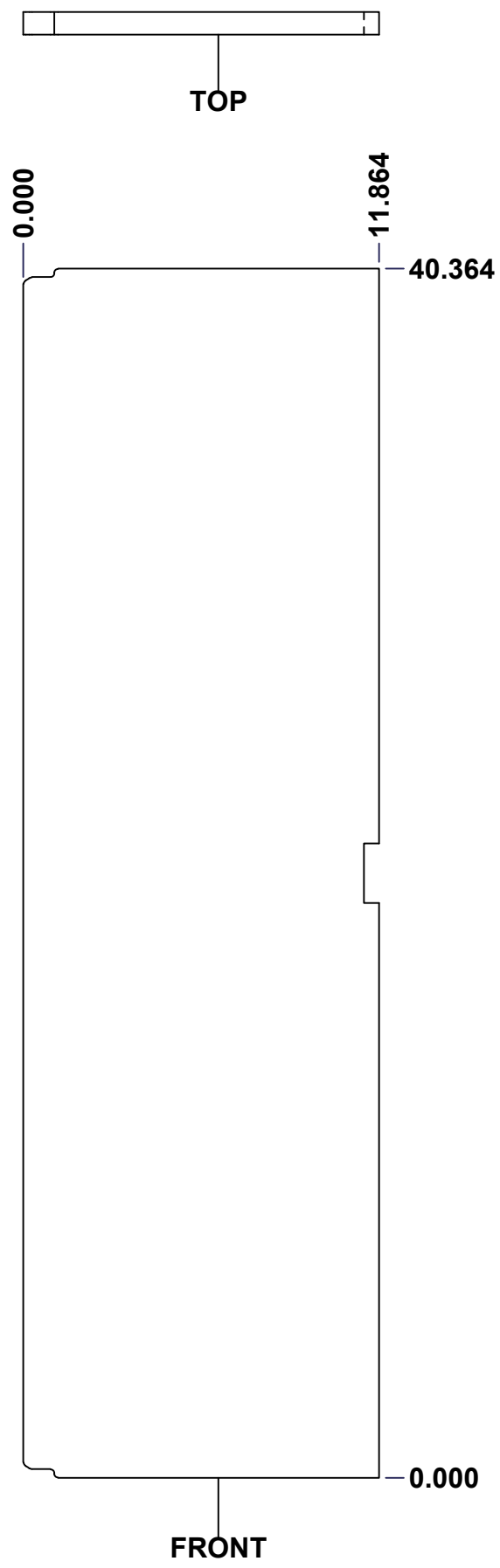

No.	Revisions	Date	By/Par

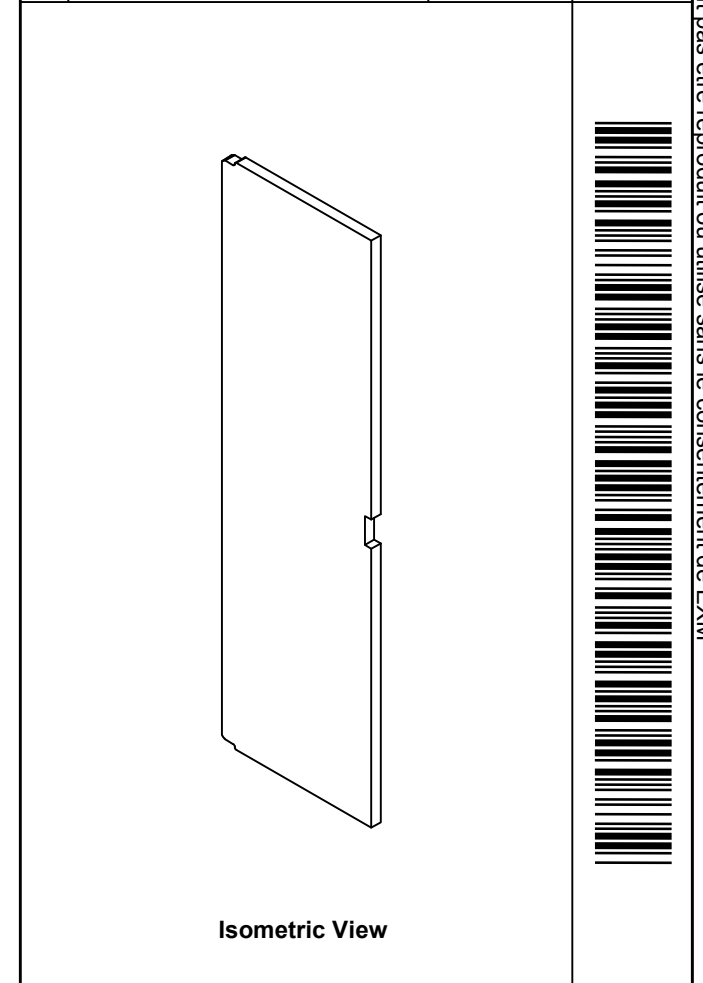

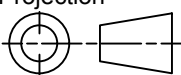
 Tél: (450) 979-4373 Fax: (450) 979-4626 www.exmweb.com		Flatness Aplatissement Max 3.0mm
Customer Client		Projection 
Drawn By / Dessiné Par: BoxCad: Patrick Deschenes		Date: 23-Jan-07
Material / Matière: Polyisocyanurate		
Color / Couleur: Aluminum	Finish / Fini: N/A	
Description: 5412ESS 42" x 24" Right Insulation		Detail Rev.
Part Number / Numéro Pièce: 5412ESS422412THI-RS		Rev. 13 / 16

SEE BILL OF MATERIAL ON LAST PAGE

This drawing is confidential and must not be reproduced or used without the consent of EXM

Ce dessin est confidentiel et ne doit pas être reproduit ou utilisé sans le consentement de EXM

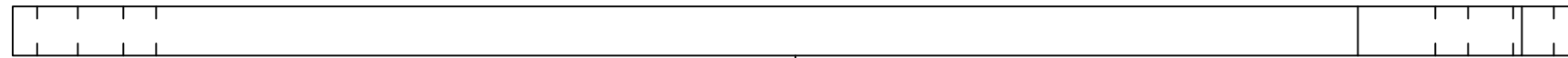

TOP



FRONT

0.000
0.750



RIGHT

No.	Revisions	Date	By/Par

Isometric View

<p>Tél: (450) 979-4373 Fax: (450) 979-4626 www.exmweb.com</p>		Flatness Aplatissement
		Max 3.0mm
		Projection
Customer Client	Date	Date
Drawn By Dessiné Par	BoxCad: Patrick Deschenes	Date 23-Jan-07
Material Matière Polyisocyanurate		
Color Couleur Aluminum	Finish Fini N/A	
Description 5412ESS 42" x 24" Top and Bottom Insulation		Detail Rev.
Part Number Numéro Pièce	Rev. 0	14 16

SEE BILL OF MATERIAL ON LAST PAGE

5412ESS422412THI-TP

This drawing is confidential and must not be reproduced or used without the consent of EXM

Ce dessin est confidentiel et ne doit pas être reproduit ou utilisé sans le consentement de EXM

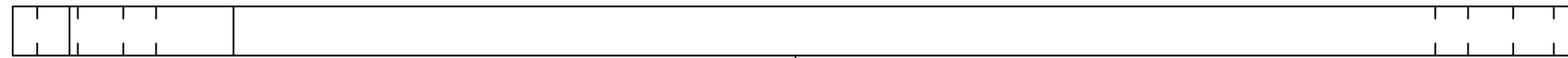

TOP

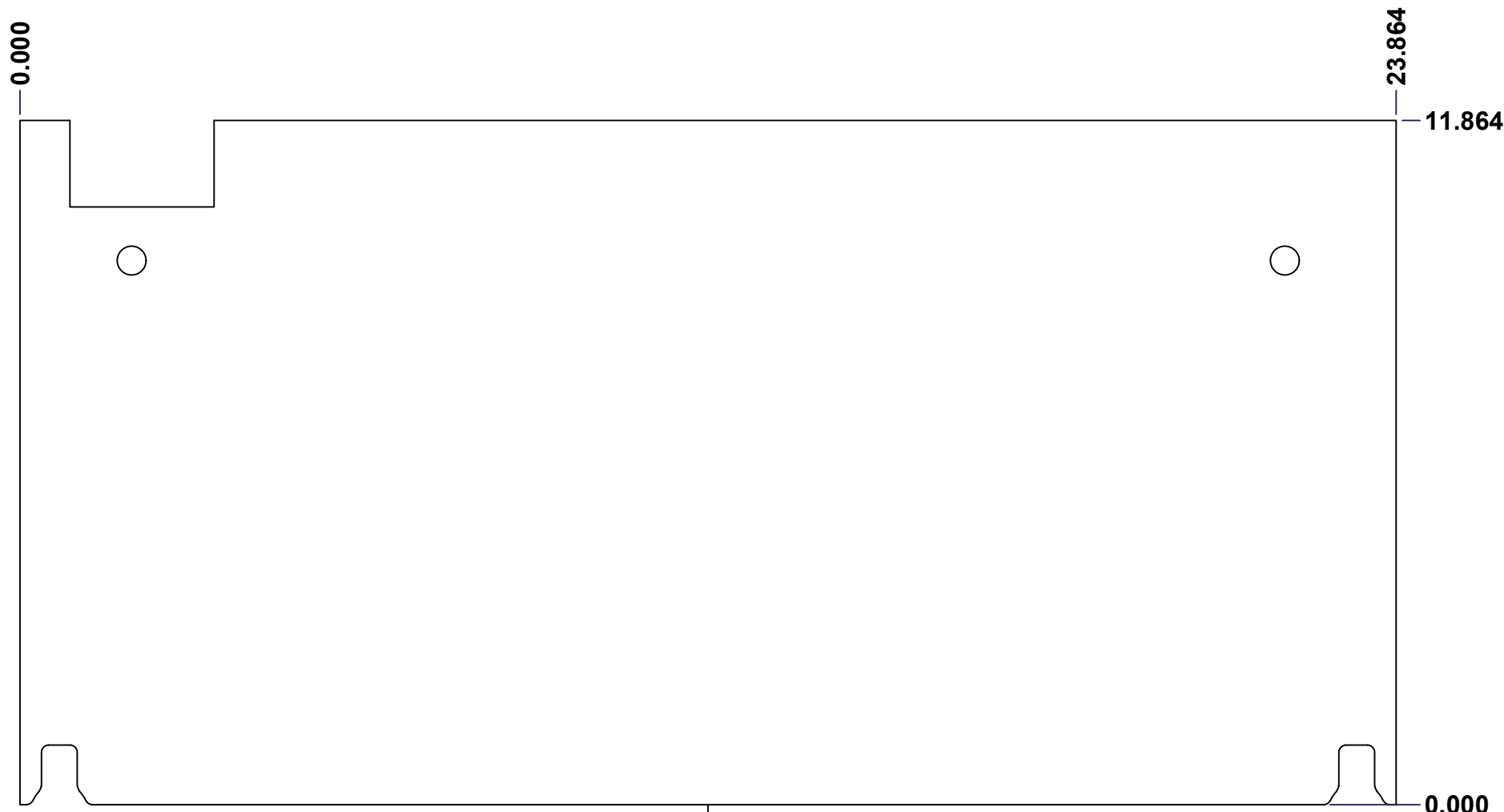

FRONT

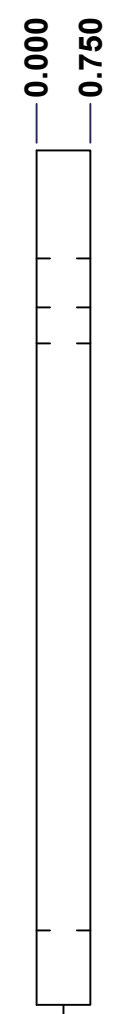

RIGHT

No.	Revisions	Date	By/Par

Isometric View

<p>Tél: (450) 979-4373 Fax: (450) 979-4626 www.exmweb.com</p>		Flatness Aplatissement	
		Max 3.0mm	
Customer Client		Date	
Drawn By Dessiné Par		Date	
Material Matière		Polyisocyanurate	
Color Couleur	Aluminum	Finish Fini	N/A
Description		Detail Rev.	
5412ESS 42" x 24" Top and Bottom Insulation			
Part Number Numéro Pièce		Rev.	15
5412ESS422412THI-BT		0	16

SEE BILL OF MATERIAL ON LAST PAGE

This drawing is confidential and must not be reproduced or used without the consent of EXM

Ce dessin est confidentiel et ne doit pas être reproduit ou utilisé sans le consentement de EXM

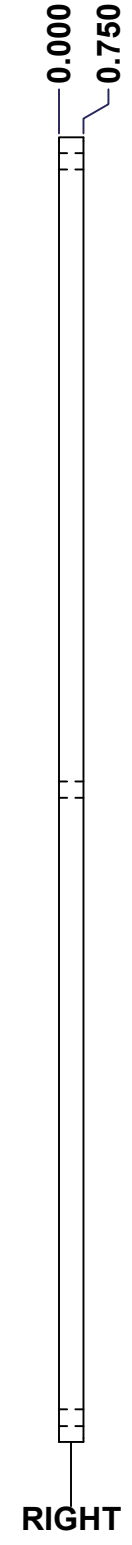
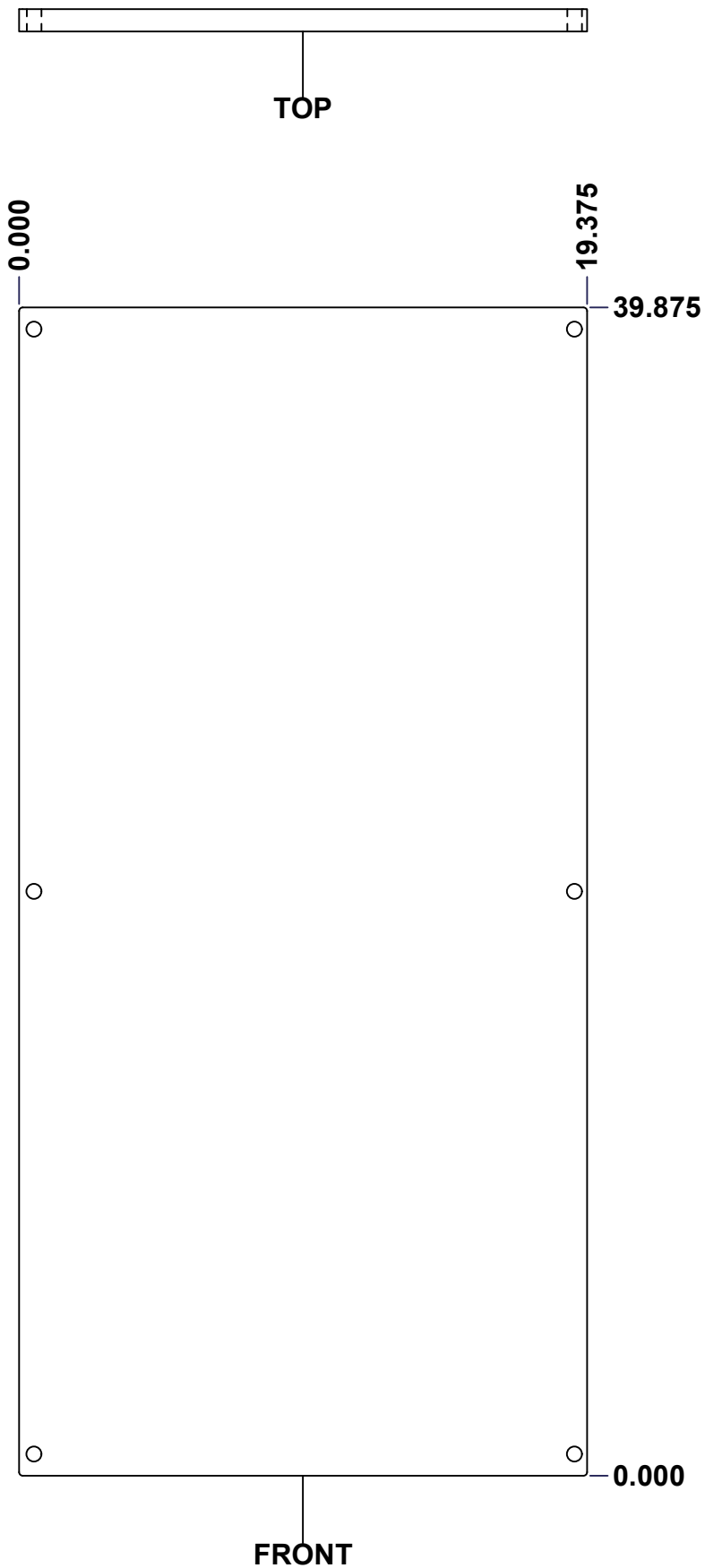

No.	Revisions	Date	By/Par

Isometric View

<p>Tél: (450) 979-4373 Fax: (450) 979-4626 www.exmweb.com</p>		Flatness Aplatissement
		Max 3.0mm
Projection		
Customer Client	Date	
Drawn By Dessiné Par	BoxCad: Patrick Deschenes	Date 23-Jan-07
Material Matière Polyisocyanurate		
Color Couleur	Aluminum	Finish Fini N/A
Description		Detail Rev.
5412ESS 42" x 24" Cover Insulation		
Part Number Numéro Pièce	Rev.	16
5412ESS422412THI-C	0	16

SEE BILL OF MATERIAL ON LAST PAGE

This drawing is confidential and must not be reproduced or used without the consent of EXM

Ce dessin est confidentiel et ne doit pas être reproduit ou utilisé sans le consentement de EXM

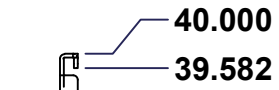
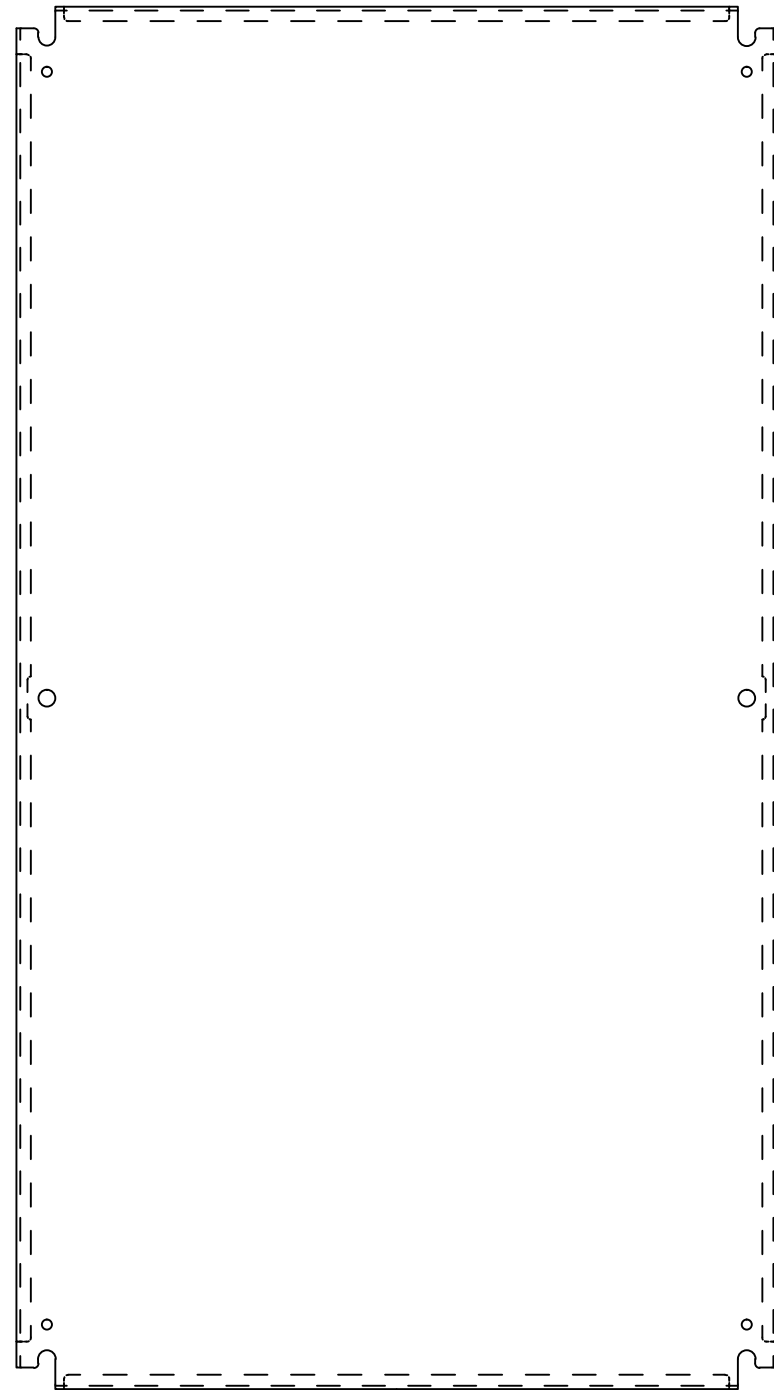
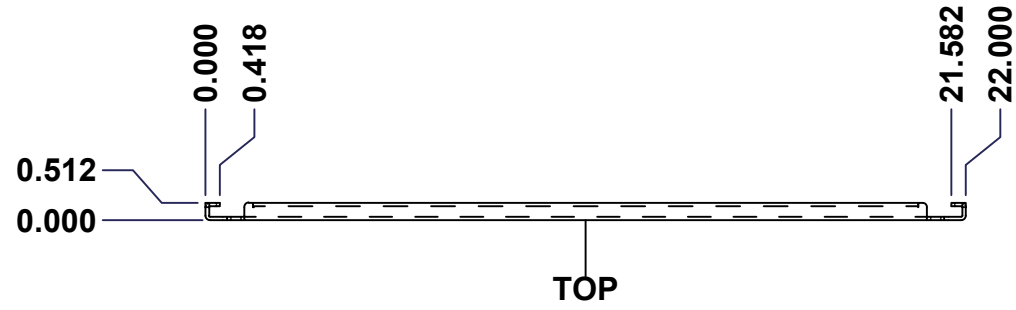

No.	Revisions	Date	By/Par

Isometric View

Tél: (450) 979-4373 Fax: (450) 979-4626 www.exmweb.com		Flatness Aplatissement Max 3.0mm Projection
Customer Client	Date	
Drawn By / Dessiné Par: BoxCad	Date: 23-Jan-07	
Material / Matière	See Part List	
Color / Couleur	See Part List	Finish / Fini: See Part List
Description: 881 SP - Inner Panel		Detail Rev.
Part Number / Numéro Pièce: 881 SP4224G	Rev.:	1 / 2

Qty	Part Number	Rev	Description	Material	Color	Finish
1	881 SP4224G-P	0	881 SP - Inner Panel Part	12 Ga Galvanized	Unpainted	Galvanized

Parts List

This drawing is confidential and must not be reproduced or used without the consent of EXM

Ce dessin est confidentiel et ne doit pas être reproduit ou utilisé sans le consentement de EXM

Table 1			FRONT VIEW
CUT-OUT	XDIM	YDIM	DESCRIPTION
1	0.875	1.875	GROUND HOLE (RND Ø0.290)
2	21.125	1.875	GROUND HOLE (RND Ø0.290)
3	0.875	38.125	GROUND HOLE (RND Ø0.290)
4	21.125	38.125	GROUND HOLE (RND Ø0.290)
5	0.875	20.000	MTG STUD HOLE (RND Ø0.500)
6	21.125	20.000	MTG STUD HOLE (RND Ø0.500)

All knockouts are actual size / Les disques défonçables sont grandeur réel

No.	Revisions	Date	By/Par

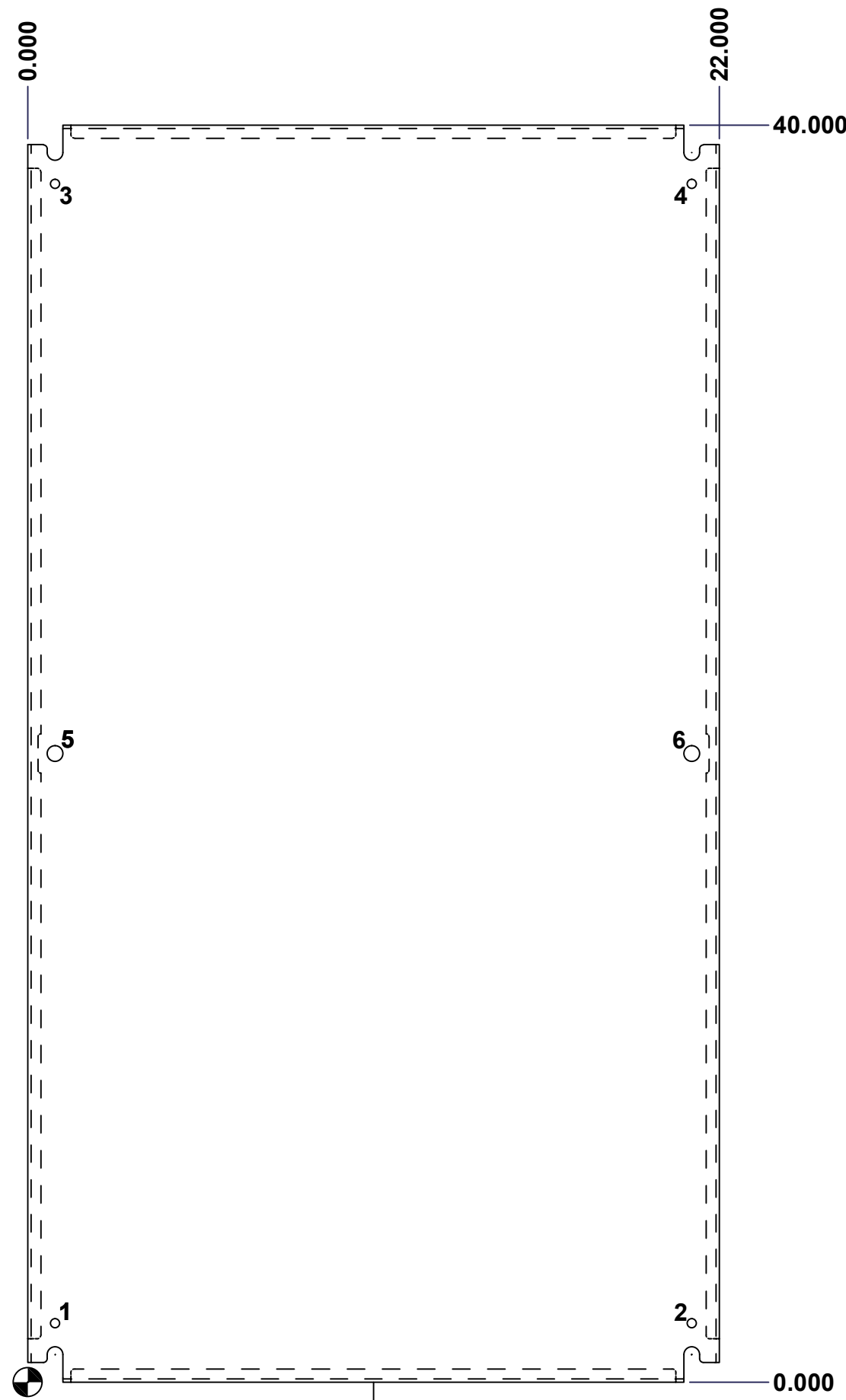

FRONT

Isometric View

		Tél: (450) 979-4373 Fax: (450) 979-4626 www.exmweb.com		Flatness Aplatissement Max 3.0mm	
Customer Client		Date		Projection 	
Drawn By Dessiné Par BoxCad		Date 23-Jan-07		Material Matière See Part List	
Color Couleur See Part List		Finish Fini See Part List		Description 881 SP - Inner Panel	
Part Number Numéro Pièce 881 SP4224G		Rev. 0		Detail Rev. 2	