

This drawing is confidential and must not be reproduced or used without the consent of EXM

Ce dessin est confidentiel et ne doit pas être reproduit ou utilisé sans le consentement de EXM

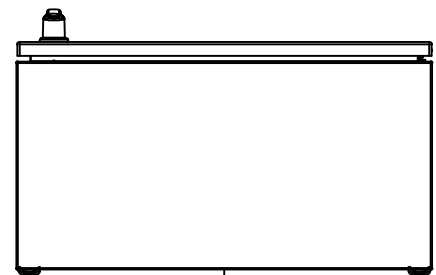

TOP

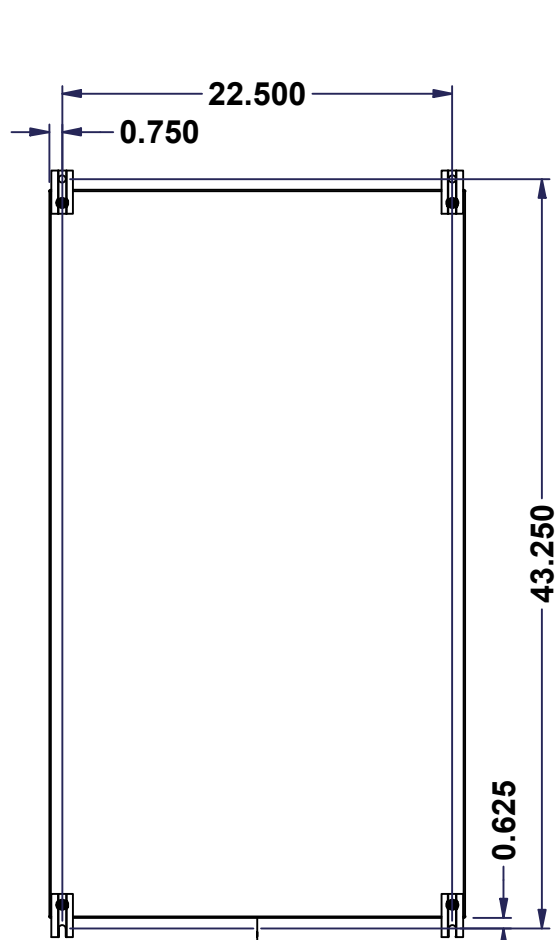

BACK

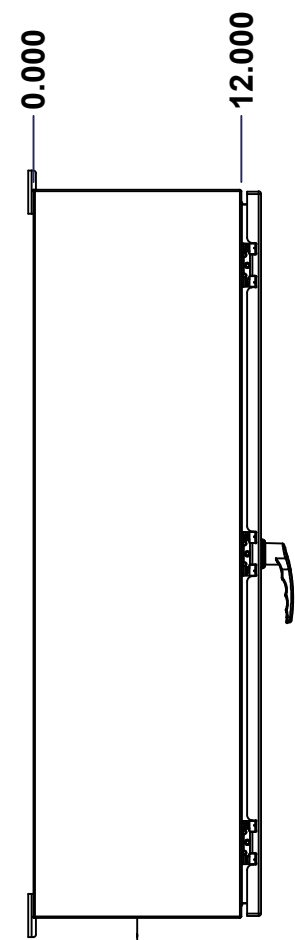

LEFT

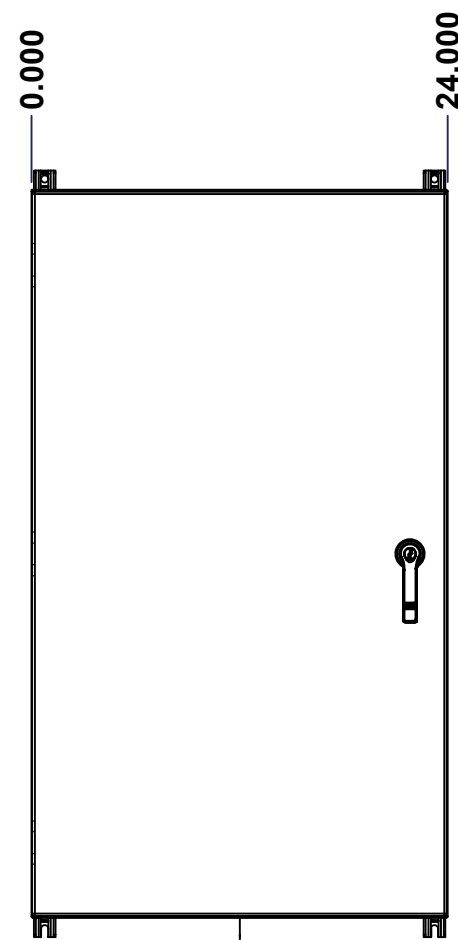

FRONT

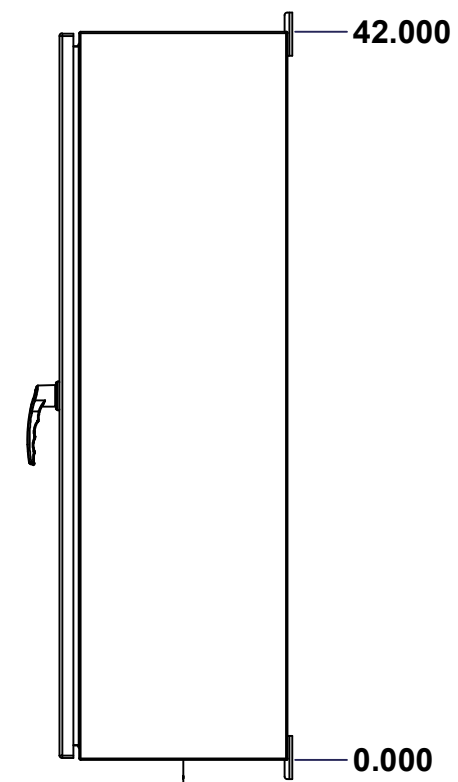

RIGHT

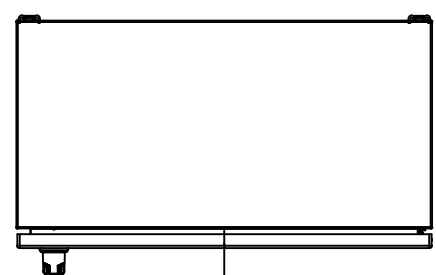

BOTTOM

No.	Revisions	Date	By/Par

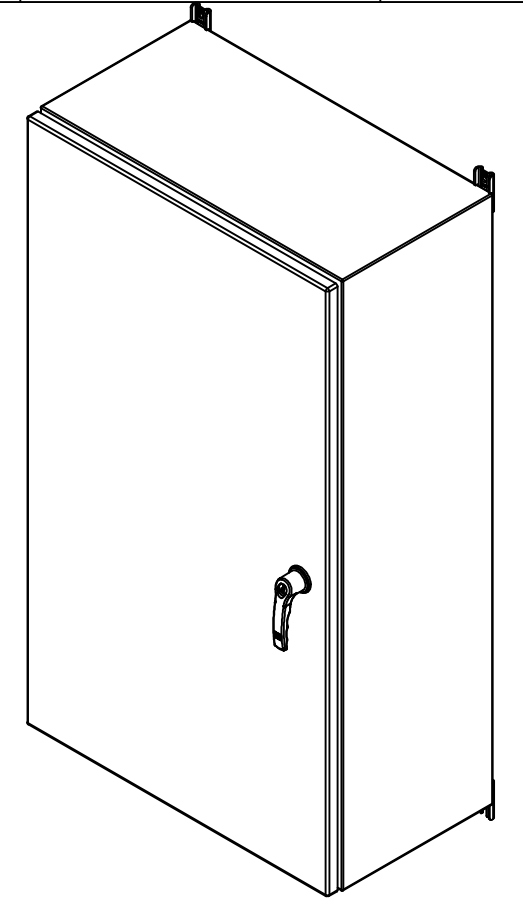

Isometric View

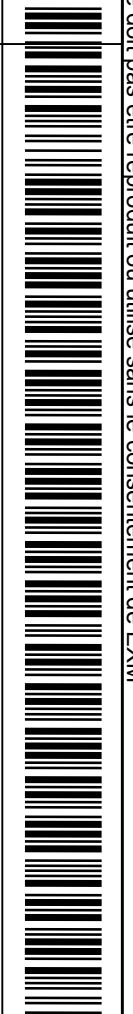

**GRAIN DIRECTION:
TOP/BOTTOM: HORIZONTAL
LEFT/RIGHT/BACK/FRONT: VERTICAL**

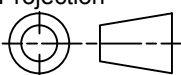
 Tél: (450) 979-4373 Fax: (450) 979-4626 www.exmweb.com		Flatness Aplatissement Max 3.0mm Projection 
Customer Client	Date	
Drawn By Dessiné Par	BoxCad: BoxCad	Date 24-May-23
Material Matière	16 Ga Stainless Steel 304 (1.4mm)	
Color Couleur	Unpainted	Finish Fini Brushed
Description	Detail Rev.	
5412ESS 42" x 24" x 12" Assembly		
Part Number Numéro Pièce	Rev. 0	1 / 16

SEE BILL OF MATERIAL ON LAST PAGE

5412ESS422412THNOIP

This drawing is confidential and must not be reproduced or used without the consent of EXM

Ce dessin est confidentiel et ne doit pas être reproduit ou utilisé sans le consentement de EXM

NOTE	
ITEM	DESCRIPTION
1	NEMA 4X Enclosure
2	C/W Standard ground studs on box and cover
3	C/W Standard door stiffener
4	W/O Inner panel
5	C/W Standard inner panel mounting studs
6	C/W 885 ESMF4_OPEN Sold separately (Installed)
7	C/W 885 ESMF4_CLOSE Sold separately (Installed)
8	C/W R5 Insulation (Installed by EXM)

No.	Revisions	Date	By/Par

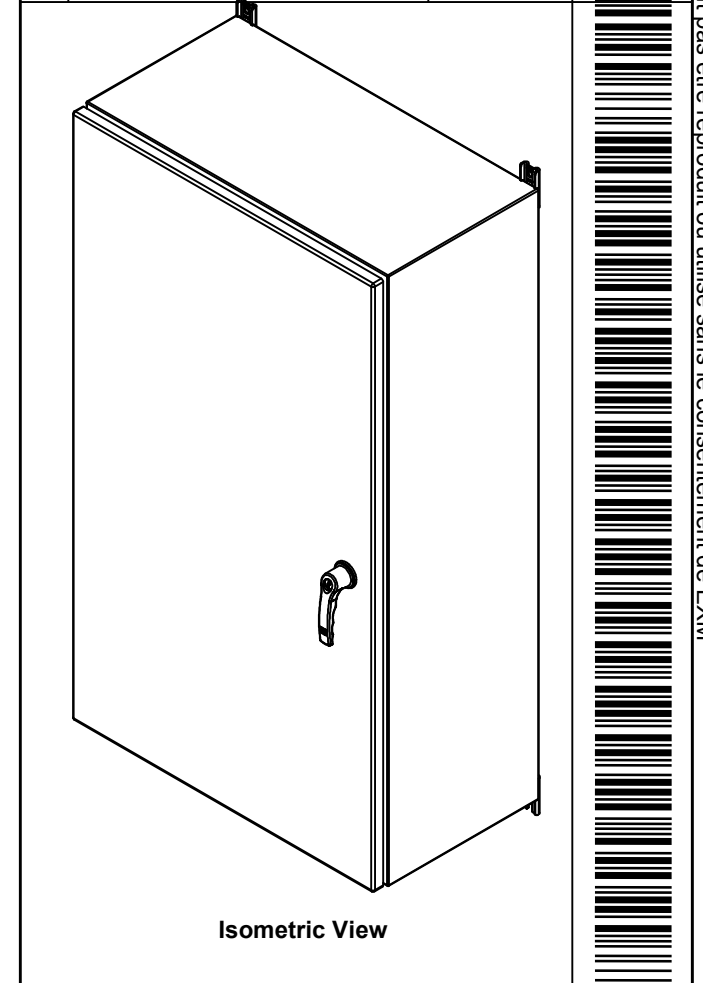

PACKING		
ITEM	QTY	DESCRIPTION
Cardboard sleeve	2	Top and Bottom
Cardboard strip	2	Between back of enclosure and inner panel
Plastic bag	1	To protect cover surface and inside gasket
Cardboard corner	4	To reinforced for the plastic strap tightening
Plastic strap - Black	2	To Squeeze the 2 cardboard sleeve together
Packaging label	3	White label with PN
Plastic strap- Green	2	To secure the enclosure to the wood pallet
Wood Pallet	1	2" deeper and 3" larger than enclosure size

6	STK-Q-00600	2	M12 to M8 Adaptor
1	STK-K-01800	5	5412 ES Accessory Kit
1	5412ESS422412THNOIP C	0	5412ESS 42" x 24" Cover
1	5412ESS422412THNOIPB	0	5412ESS 42" x 24" x 12" Body
3	STK-Q-04051-08	1	M6 x 8mm Stainless Steel Hexagon Socket Head Machine Screw with Nyseal
Qty	Part Number	Rev	Description
Parts List			

		Flatness Aplatissement Max 3.0mm Projection 	
Tél: (450) 979-4373 Fax: (450) 979-4626 www.exmweb.com		Customer Client Date	
Drawn By Dessiné Par BoxCad: BoxCad		Date 24-May-23	
Material Matière 16 Ga Stainless Steel 304 (1.4mm)		Color Couleur Unpainted	
Description 5412ESS 42" x 24" x 12" Assembly		Finish Fini Brushed	
Part Number Numéro Pièce 5412ESS422412THNOIP		Detail Rev. Rev. 2 0	

This drawing is confidential and must not be reproduced or used without the consent of EXM

Ce dessin est confidentiel et ne doit pas être reproduit ou utilisé sans le consentement de EXM

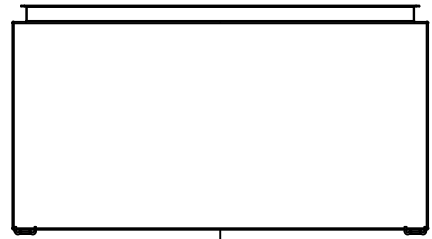

TOP

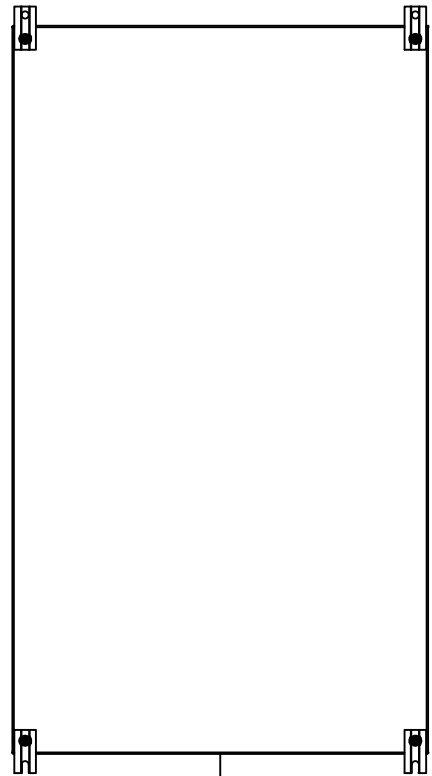

BACK

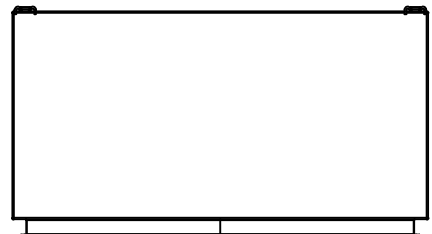

BOTTOM

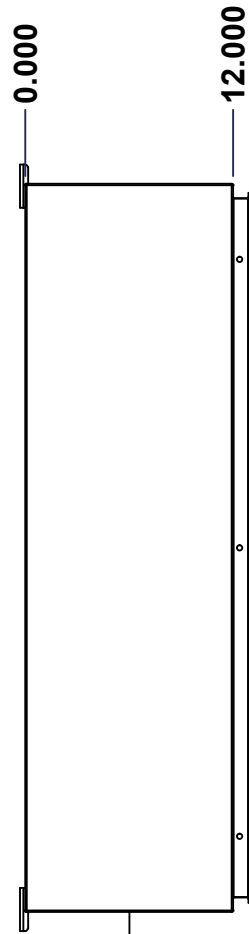

LEFT

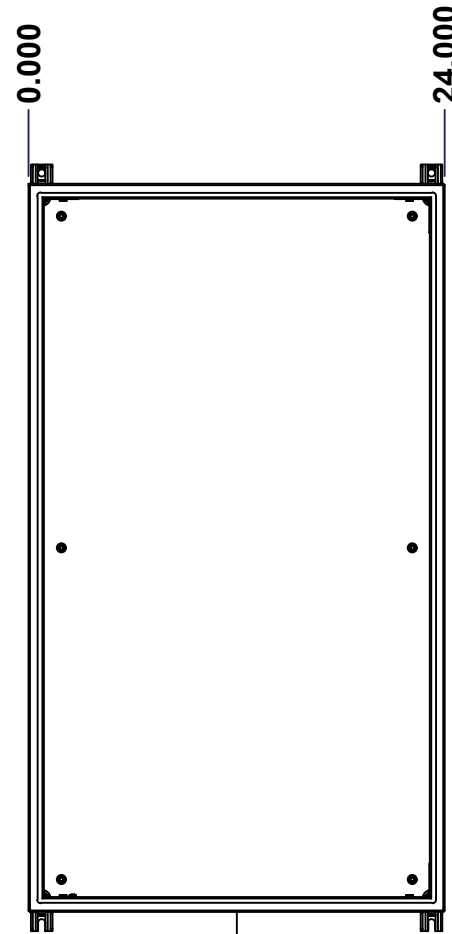

FRONT

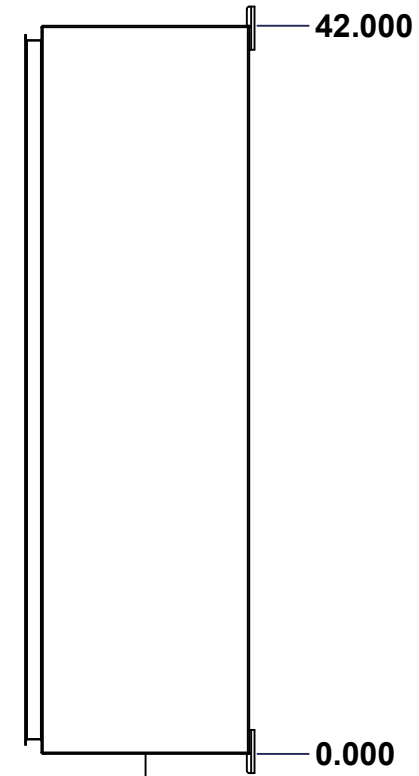

RIGHT

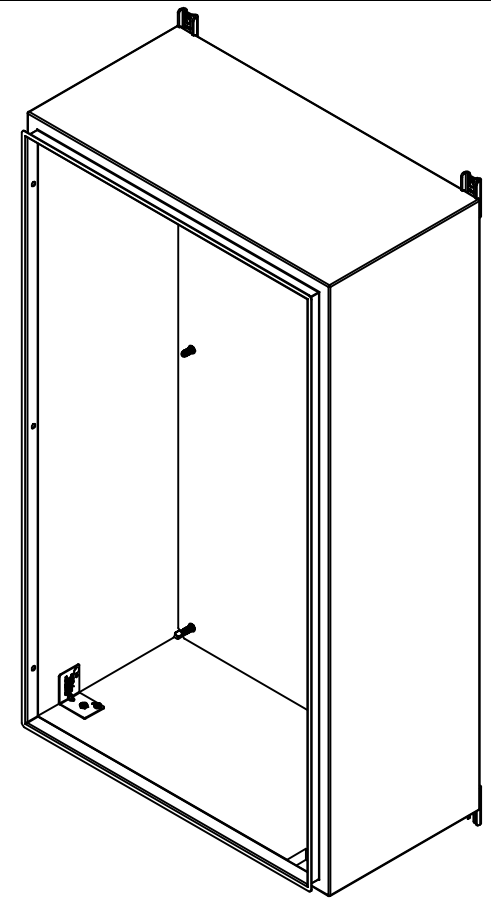

Isometric View

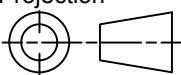

No.	Revisions	Date	By/Par

 Tél: (450) 979-4373 Fax: (450) 979-4626 www.exmweb.com		Flatness Aplatissement Max 3.0mm Projection 
Customer Client	Date	
Drawn By Dessiné Par	BoxCad: BoxCad	Date 24-May-23
Material Matière	16 Ga Stainless Steel 304 (1.4mm)	
Color Couleur	Unpainted	Finish Fini Brushed
Description	Detail Rev.	
5412ESS 42" x 24" x 12" Body		
Part Number Numéro Pièce	Rev.	3
SEE BILL OF MATERIAL ON LAST PAGE 5412ESS422412THNOIPB	0	16

This drawing is confidential and must not be reproduced or used without the consent of EXM

Ce dessin est confidentiel et ne doit pas être reproduit ou utilisé sans le consentement de EXM

STANDARD FEATURES ARE NOT LISTED IN THIS HOLE TABLE			
HOLE TABLE - TOP VIEW (CUSTOM FEATURE ONLY)			
CUT-OUT	XDIM	YDIM	DESCRIPTION
1	2.000	9.500	INSUL. STUD M6 x 18mm (Inside)
2	22.000	9.500	INSUL. STUD M6 x 18mm (Inside)

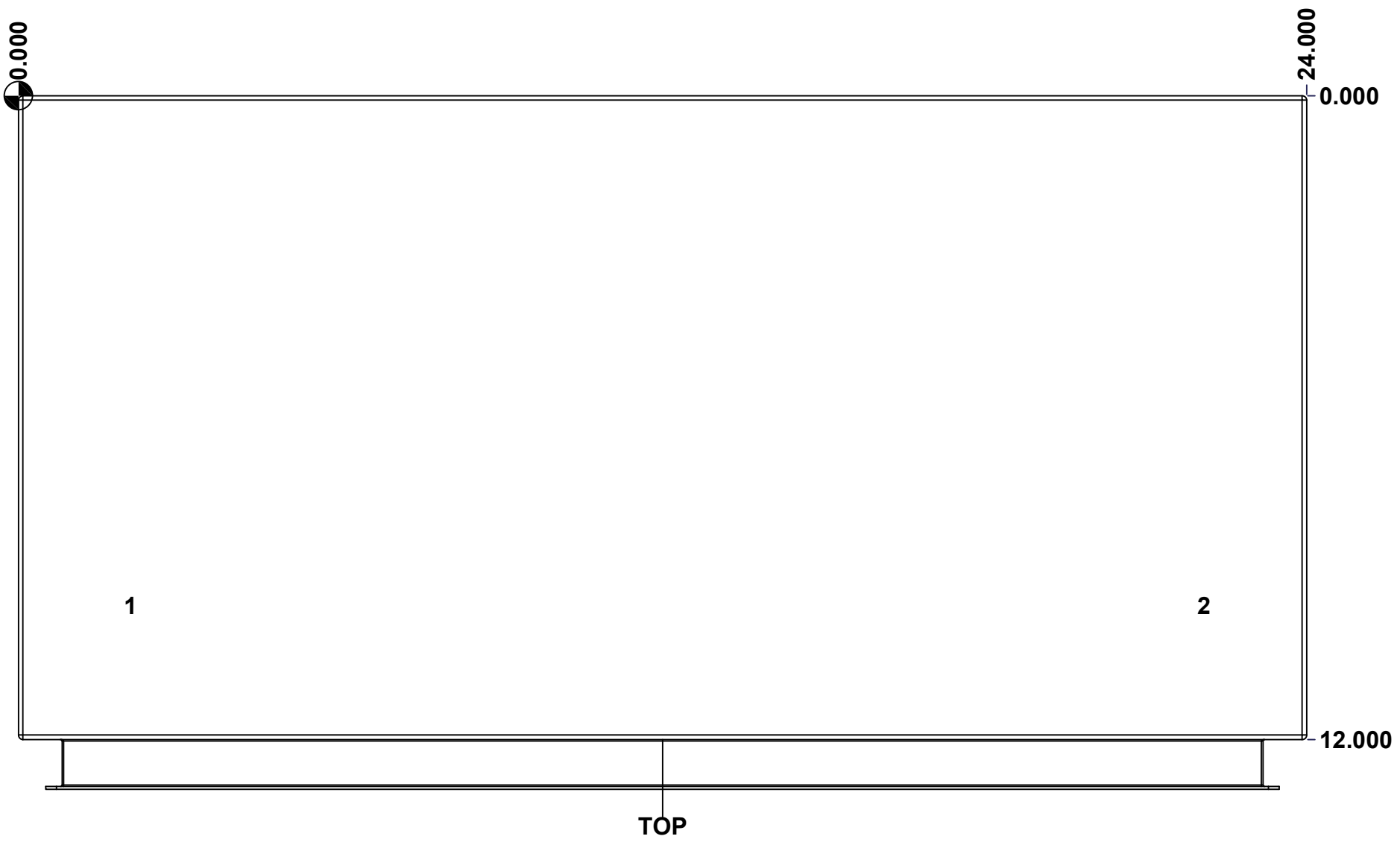

	Description	Status
	5412ESS 42" x 24" x 12" Body	(NULL)
	Part Number Numéro Pièce	Rev.
	5412ESS422412THNOIPB	0
		4
		16

This drawing is confidential and must not be reproduced or used without the consent of EXM

Ce dessin est confidentiel et ne doit pas être reproduit ou utilisé sans le consentement de EXM

STANDARD FEATURES ARE NOT LISTED IN THIS HOLE TABLE

HOLE TABLE - BOTTOM VIEW (CUSTOM FEATURE ONLY)

CUT-OUT	XDIM	YDIM	DESCRIPTION
1	2.000	9.500	INSUL. STUD M6 x 18mm (Inside)
2	22.000	9.500	INSUL. STUD M6 x 18mm (Inside)



	Description	Status
	5412ESS 42" x 24" x 12" Body	(NULL)
	Part Number Numéro Pièce	Rev.
	5412ESS422412THNOIPB	0
		5
		16

This drawing is confidential and must not be reproduced or used without the consent of EXM

Ce dessin est confidentiel et ne doit pas être reproduit ou utilisé sans le consentement de EXM

STANDARD FEATURES ARE NOT LISTED IN THIS HOLE TABLE

HOLE TABLE - BACK VIEW (CUSTOM FEATURE ONLY)

CUT-OUT	XDIM	YDIM	DESCRIPTION
1	1.875	1.875	IP STUD M8 x 35mm (Inside)
2	1.875	40.125	IP STUD M8 x 35mm (Inside)
3	22.125	40.125	IP STUD M8 x 35mm (Inside)
4	22.125	1.875	IP STUD M8 x 35mm (Inside)
5	1.875	21.000	IP STUD M8 x 35mm (Inside)
6	22.125	21.000	IP STUD M8 x 35mm (Inside)

7	23.250	0.000	FOOT 885 ESMF4_OPEN
8	0.750	0.000	FOOT 885 ESMF4_OPEN
9	23.250	42.000	FOOT 885 ESMF4_CLOSE
10	0.750	42.000	FOOT 885 ESMF4_CLOSE

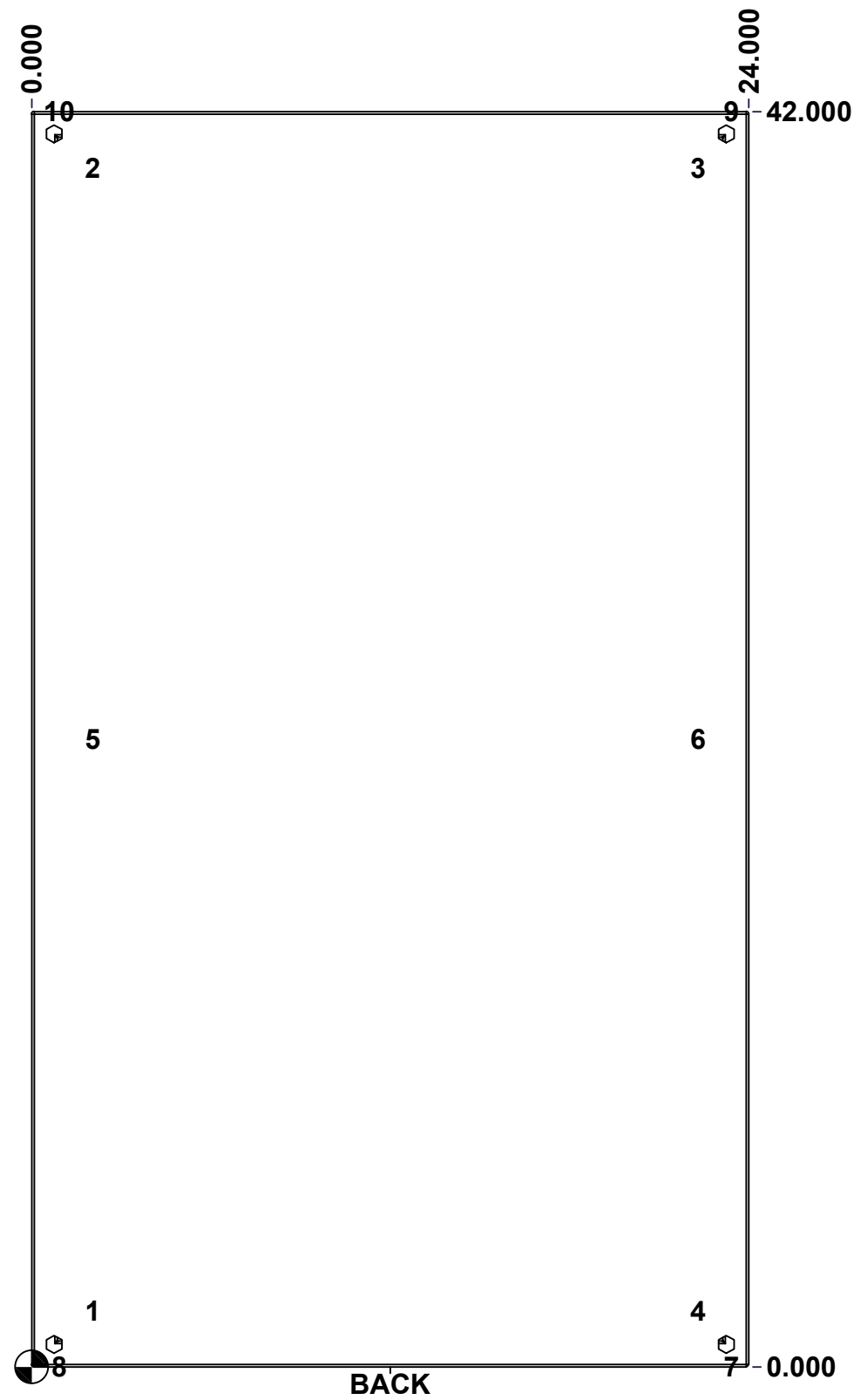

	Description	Status
	5412ESS 42" x 24" x 12" Body	(NULL)
	Part Number Numéro Pièce	Rev.
	5412ESS422412THNOIPB	0 / 6
		16

This drawing is confidential and must not be reproduced or used without the consent of EXM

Ce dessin est confidentiel et ne doit pas être reproduit ou utilisé sans le consentement de EXM

No.	Revisions	Date	By/Par

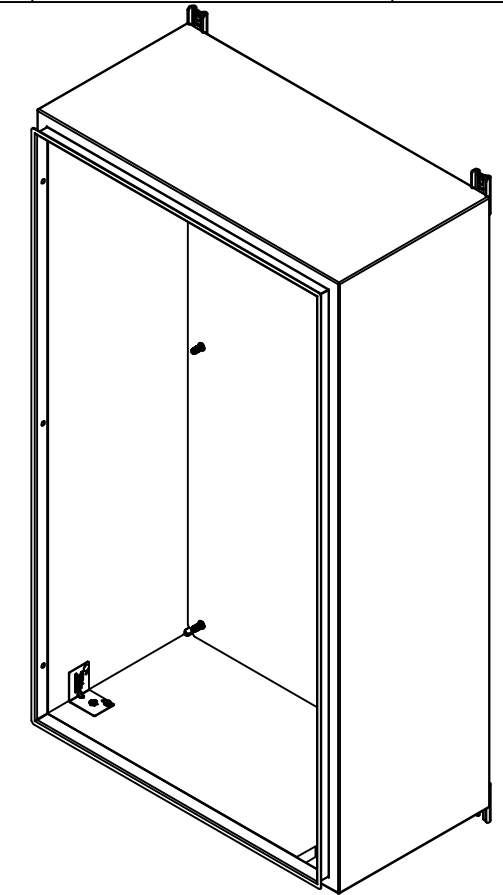

Isometric View



2	885ESMF4-FEET	0	885 ESMF4 Stainless Steel Mounting Foot
4	RIVET_NUT_SS_M10_FH_CE	0	Stainless Steel Rivet Nut M10 (Low Profile Close End)
4	STK-Q-06670	2	M10 x 16mm Stainless Steel Machine Screw
2	885ESMF4-FEET-A	0	885 ESMF4 Stainless Steel Mounting Foot (Opened Slot)
1	STK-K-70554	3	5412 ESTH Accessory Kit
1	5412ESS422412THNOIPI-RS	0	5412ESS 42" x 24" Right Insulation
1	5412ESS422412THNOIPI-LS	0	5412ESS 42" x 24" Left Insulation
1	5412ESS422412THNOIPI-BT	0	5412ESS 42" x 24" Top and Bottom Insulation
1	5412ESS422412THNOIPI-TP	0	5412ESS 42" x 24" Top and Bottom Insulation
1	5412ESS422412THNOIPI-B	0	5412ESS 42" x 24" Back Insulation
4	STK-Q-16070	1	Stud M6 x 18mm Stainless steel
6	STK-Q-16020	1	Stud M8 x 35mm Stainless Steel
1	5412ESS422412THNOIPB-P	0	5412ESS 42" x 24" x 12" Body Part
Qty	Part Number	Rev	Description
Parts List			

<p>Tél: (450) 979-4373 Fax: (450) 979-4626 www.exmweb.com</p>	Flatness Aplatissement Max 3.0mm
	Projection
Customer Client	Date
Drawn By Dessiné Par	BoxCad: BoxCad Date 24-May-23
Material Matière	16 Ga Stainless Steel 304 (1.4mm)
Color Couleur	Unpainted Finish Fini Brushed
Description	Detail Rev.
5412ESS 42" x 24" x 12" Body	
Part Number Numéro Pièce	Rev. 7
5412ESS422412THNOIPB	0 / 16

This drawing is confidential and must not be reproduced or used without the consent of EXM

Ce dessin est confidentiel et ne doit pas être reproduit ou utilisé sans le consentement de EXM

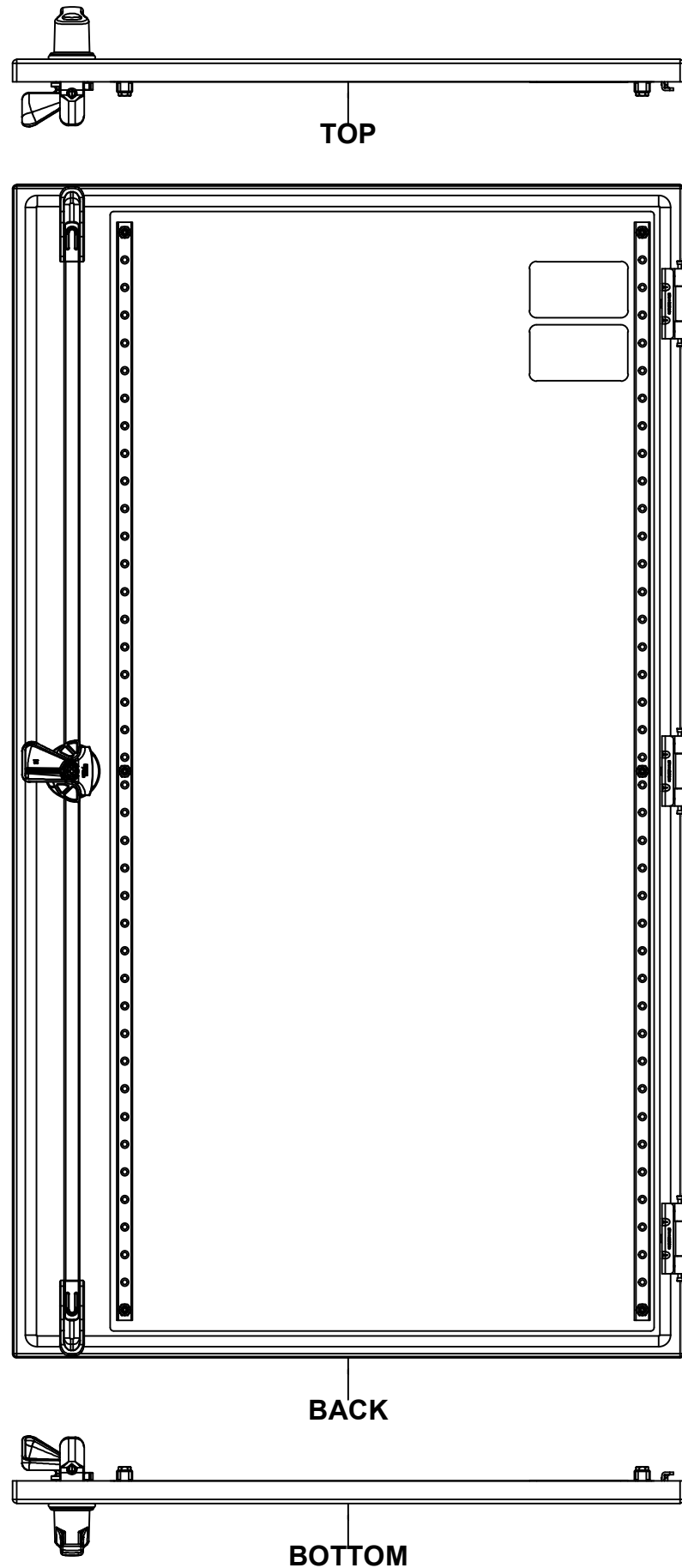

0.000
0.800
0.000
23.918
41.803
0.000

No.	Revisions	Date	By/Par

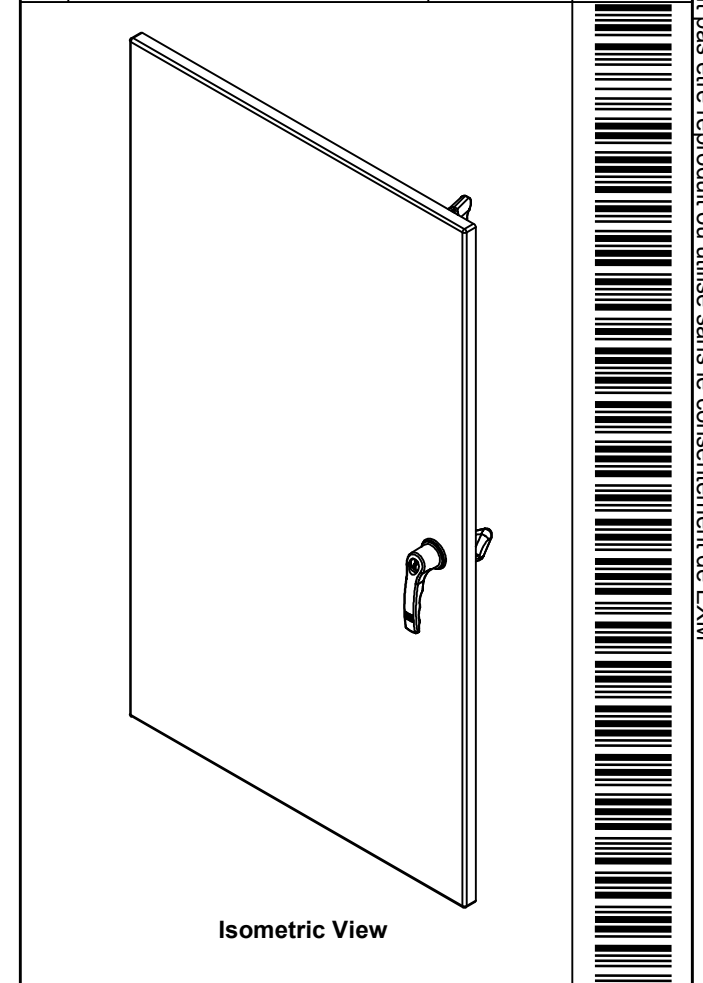

Tél: (450) 979-4373 Fax: (450) 979-4626 www.exmweb.com		Flatness Aplatissement	Max 3.0mm
		Projection	
Customer Client		Date	
Drawn By Dessiné Par	BoxCad: BoxCad	Date	24-May-23
Material Matière	16 Ga Stainless Steel 304 (1.4mm)		
Color Couleur	Unpainted	Finish Fini	Brushed
Description	5412ESS 42" x 24" Cover		Detail Rev.
Part Number Numéro Pièce	5412ESS422412THNOIPC	Rev.	8
SEE BILL OF MATERIAL ON LAST PAGE		0	16

This drawing is confidential and must not be reproduced or used without the consent of EXM

Ce dessin est confidentiel et ne doit pas être reproduit ou utilisé sans le consentement de EXM

STANDARD FEATURES ARE NOT LISTED IN THIS HOLE TABLE			
HOLE TABLE - FRONT VIEW (CUSTOM FEATURE ONLY)			
CUT-OUT	XDIM	YDIM	DESCRIPTION
1	1.486	1.709	STUD M6 x 18mm (Inside)
2	1.486	40.094	STUD M6 x 18mm (Inside)
3	19.923	40.094	STUD M6 x 18mm (Inside)
4	19.923	1.709	STUD M6 x 18mm (Inside)
5	1.486	20.902	STUD M6 x 18mm (Inside)
6	19.923	20.902	STUD M6 x 18mm (Inside)
7	21.803	36.896	CLOSING BAR STUD (Inside)
8	21.803	4.907	CLOSING BAR STUD (Inside)
-----	-----	-----	-----
9	21.803	20.902	885 ESL2A-LSS

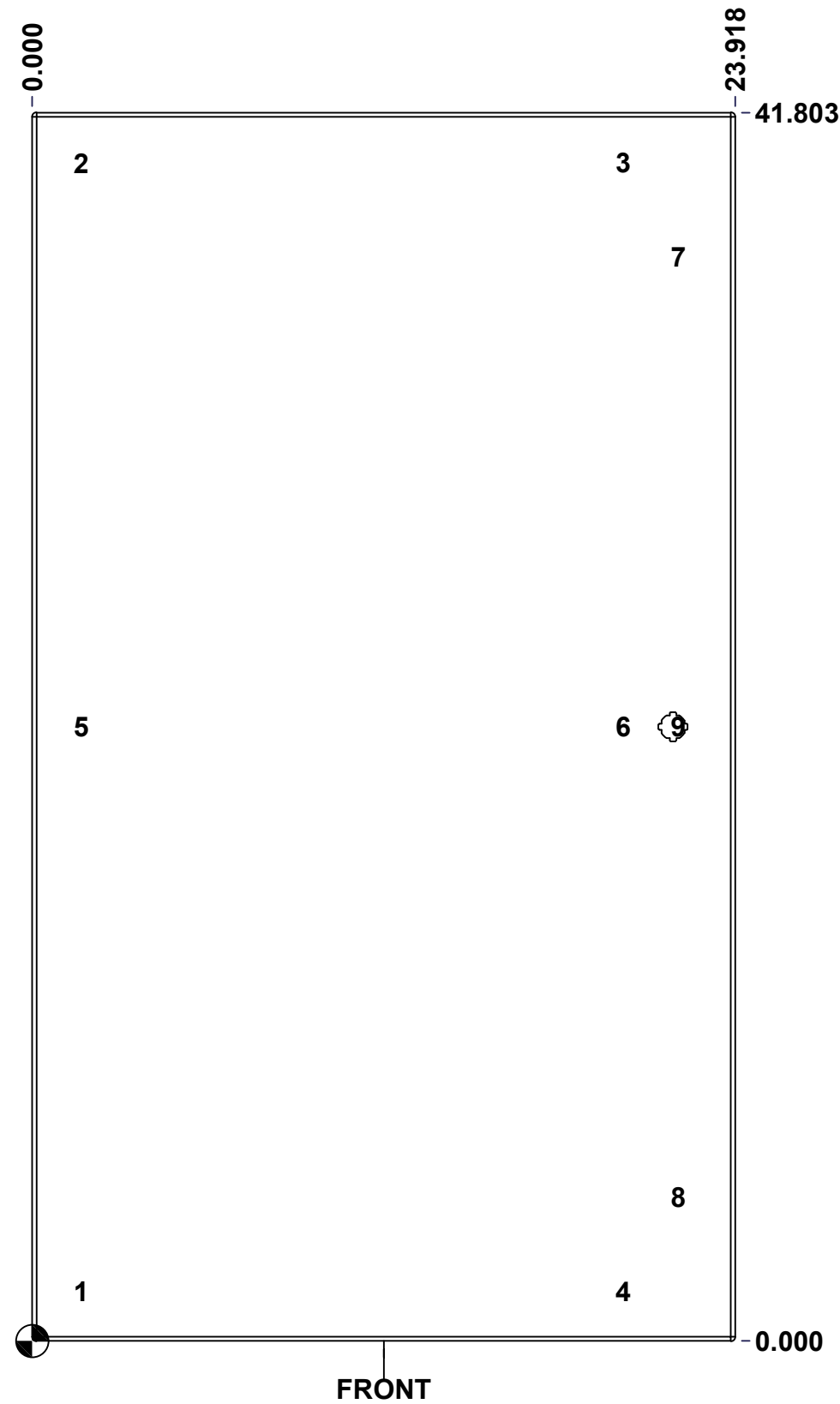

	Description	Status
	5412ESS 42" x 24" Cover	(NULL)
	Part Number Numéro Pièce	Rev.
	5412ESS422412THNOIPC	0
		9
		16

This drawing is confidential and must not be reproduced or used without the consent of EXM

Ce dessin est confidentiel et ne doit pas être reproduit ou utilisé sans le consentement de EXM

No.	Revisions	Date	By/Par

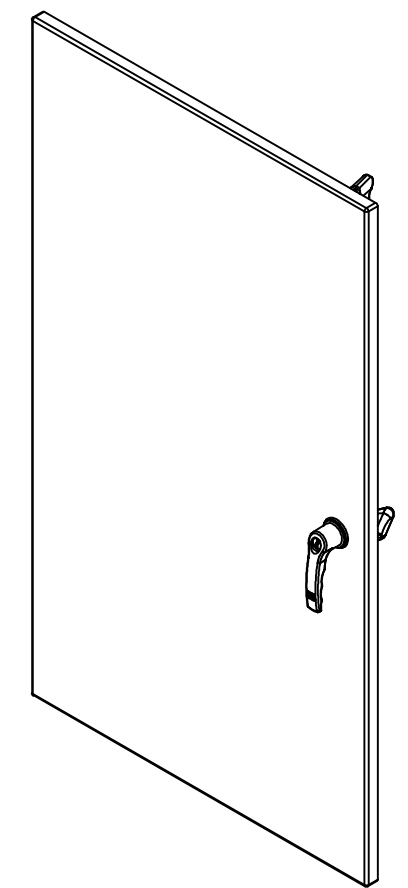

Isometric View



2	STK-Q-90042	4	5412 ES - Cabinet Closing Bar End (Small)
2	STK-Q-45655-42	0	5412 ES - Closing Bar
1	STK-Q-50536	13	5412 ES - Handle Cam Clockwise (Grip 32mm)
1	STK-Q-90051	3	5412 ES - Handle Cam Spacer
1	885 ESL2A-LSS	3	5412 ESS Key Lock L-Handle (3 Pts)
2	STK-S-00100	0	3.5" x 2" Silver Milar Flexcon Sticker
6	STK-Q-07250	2	M6 x 16mm Collar Nut
2	STK-Q-46020-42	5	5412 ES Vertical Door Stiffener 42"
1	5412ESS422412THNOIP-C	0	5412ESS 42" x 24" Cover Insulation
2	STK-Q-16407	2	Guide Stud - Small (No Paint Cap Required)
6	STK-Q-16070	1	Stud M6 x 18mm Stainless steel
1	5412ESS422412THNOIP-G	0	5412ESS 42" x 24" Cover Gasket Part
1	5412ESS422412THNOIP-C-P	0	5412ESS 42" x 24" Cover Part
3	STK-A-33016	0	5412 ESS Bended Hinge (Body Part)

QTY	Part Number	Rev	Description
Parts List			



Tél: (450) 979-4373
Fax: (450) 979-4626
www.exmweb.com

Flatness
Aplatissement
Max 3.0mm

Projection

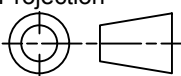

Customer Client	Date
Drawn By Dessiné Par BoxCad: BoxCad	Date 24-May-23
Material Matière 16 Ga Stainless Steel 304 (1.4mm)	
Color Couleur Unpainted	Finish Fini Brushed
Description 5412ESS 42" x 24" Cover	Detail Rev.
Part Number Numéro Pièce 5412ESS422412THNOIPC	Rev. 0

This drawing is confidential and must not be reproduced or used without the consent of EXM

Ce dessin est confidentiel et ne doit pas être reproduit ou utilisé sans le consentement de EXM

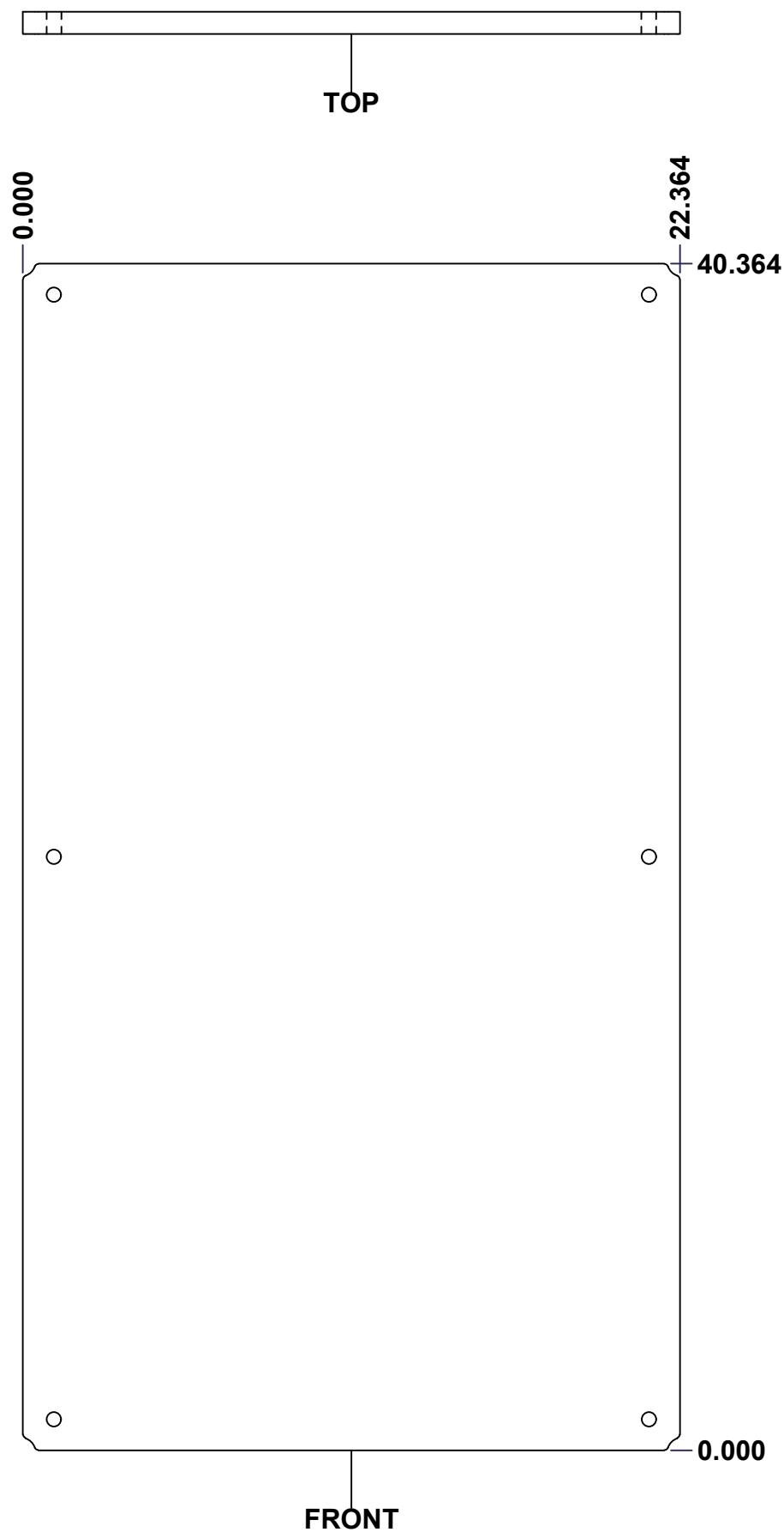

No.	Revisions	Date	By/Par

Isometric View

<p>Tél: (450) 979-4373 Fax: (450) 979-4626 www.exmweb.com</p>		Flatness Aplatissement	
		Max 3.0mm	
Customer Client		Date	
Drawn By Dessiné Par		Date	
Material Matière		Polyisocyanurate	
Color Couleur		Aluminum	Finish Fini
Description		Detail Rev.	
5412ESS 42" x 24" Back Insulation			
Part Number Numéro Pièce		Rev.	11
5412ESS422412THNOIPI-B		0	16

SEE BILL OF MATERIAL ON LAST PAGE

This drawing is confidential and must not be reproduced or used without the consent of EXM

Ce dessin est confidentiel et ne doit pas être reproduit ou utilisé sans le consentement de EXM

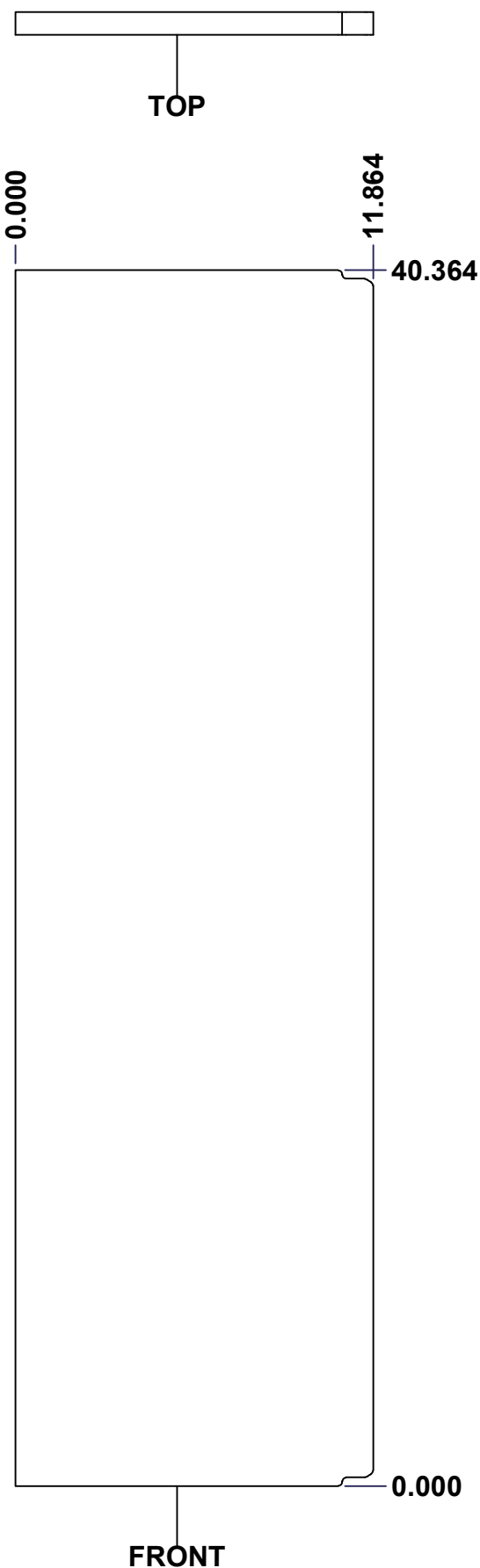

No.	Revisions	Date	By/Par

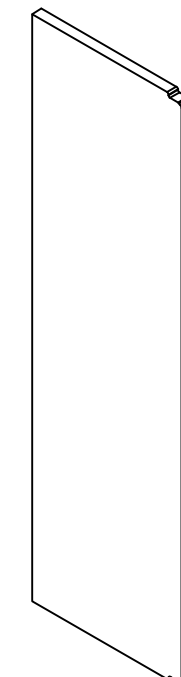

Isometric View



Tél: (450) 979-4373
 Fax: (450) 979-4626
www.exmweb.com

Flatness
Aplatissement

Max 3.0mm

Projection

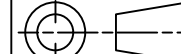

Customer Client	Date
Drawn By / Dessiné Par: BoxCad: Patrick Deschenes	Date: 23-Jan-07
Material / Matière: Polyisocyanurate	
Color / Couleur: Aluminum	Finish / Fini: N/A
Description: 5412ESS 42" x 24" Left Insulation	Detail Rev.

Part Number / Numéro Pièce: 5412ESS422412THNOIPI-LS	Rev. 0	12	16
---	--------	----	----

SEE BILL OF MATERIAL ON LAST PAGE

This drawing is confidential and must not be reproduced or used without the consent of EXM

Ce dessin est confidentiel et ne doit pas être reproduit ou utilisé sans le consentement de EXM

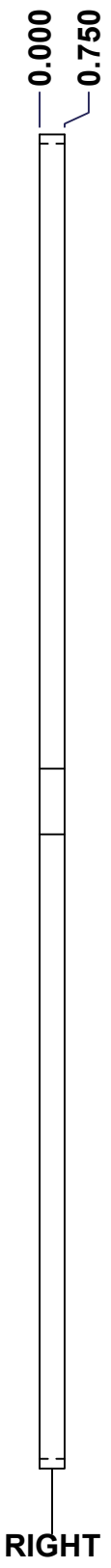
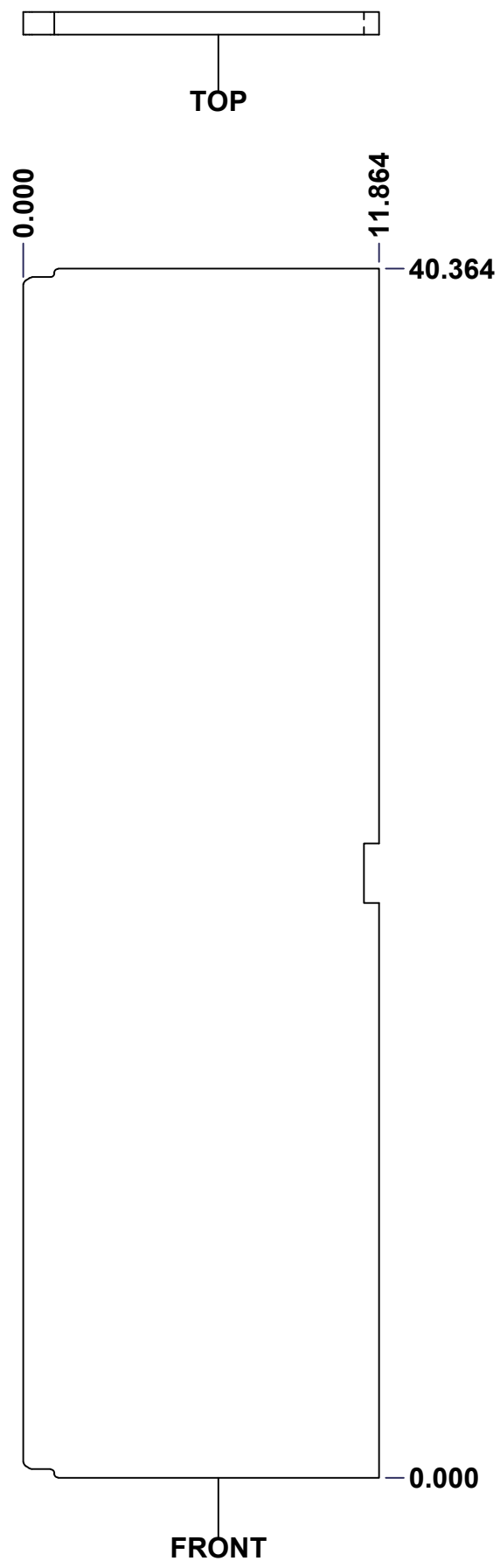

No.	Revisions	Date	By/Par

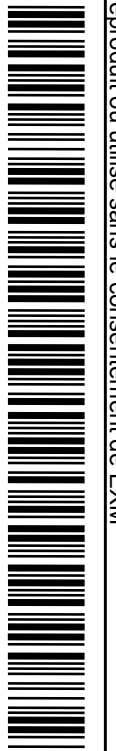
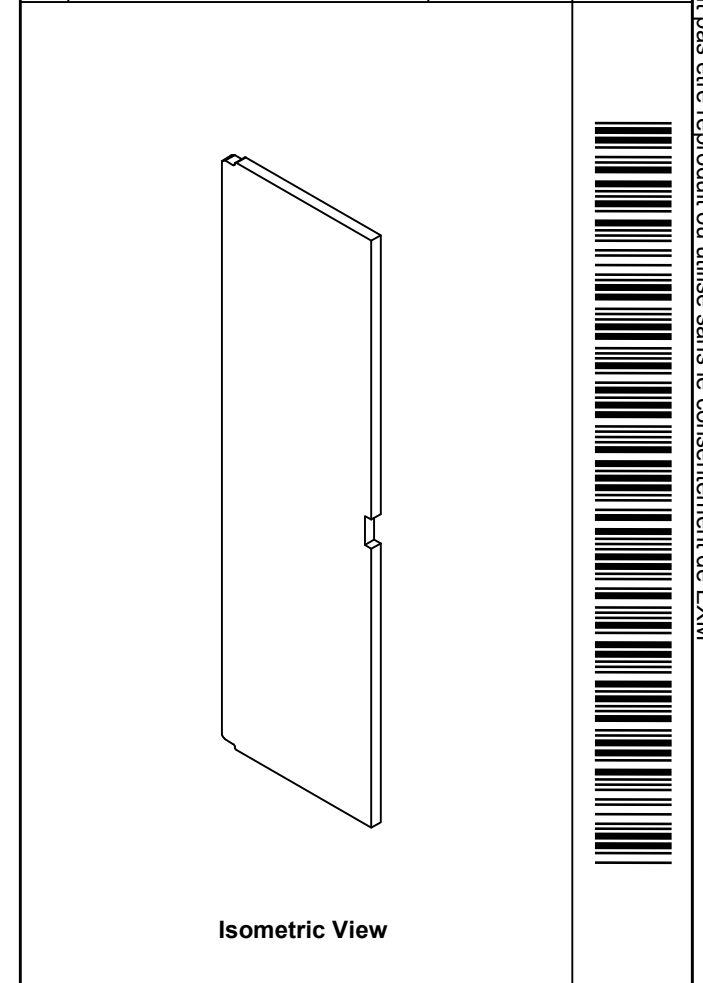

 Tél: (450) 979-4373 Fax: (450) 979-4626 www.exmweb.com		Flatness Aplatissement	
		Max 3.0mm	
Customer Client		Date	
Drawn By Dessiné Par		Date 23-Jan-07	
Material Matière		Polyisocyanurate	
Color Couleur	Aluminum	Finish Fini	N/A
Description			Detail Rev.
5412ESS 42" x 24" Right Insulation			
Part Number Numéro Pièce		Rev.	13
5412ESS422412THNOIPI-RS		0	16

SEE BILL OF MATERIAL ON LAST PAGE

This drawing is confidential and must not be reproduced or used without the consent of EXM

Ce dessin est confidentiel et ne doit pas être reproduit ou utilisé sans le consentement de EXM

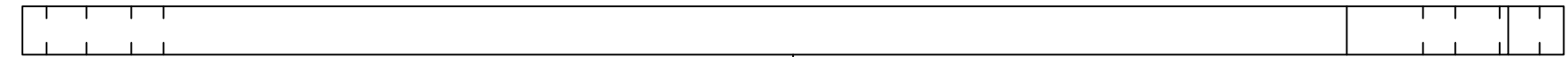

TOP



FRONT

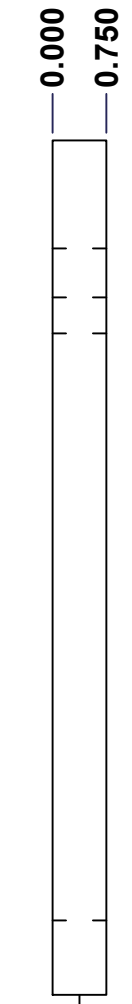

RIGHT

No.	Revisions	Date	By/Par

Isometric View

<p>Tél: (450) 979-4373 Fax: (450) 979-4626 www.exmweb.com</p>		Flatness Aplatissement
		Max 3.0mm
Customer Client		Date
Drawn By / Dessiné Par: BoxCad: Patrick Deschenes		Date: 23-Jan-07
Material / Matière: Polyisocyanurate		
Color / Couleur: Aluminum	Finish / Fini: N/A	
Description: 5412ESS 42" x 24" Top and Bottom Insulation		Detail Rev.
Part Number / Numéro Pièce: 5412ESS422412THNOIPI-TP		Rev. 14

SEE BILL OF MATERIAL ON LAST PAGE 5412ESS422412THNOIPI-TP 0 16

This drawing is confidential and must not be reproduced or used without the consent of EXM

Ce dessin est confidentiel et ne doit pas être reproduit ou utilisé sans le consentement de EXM

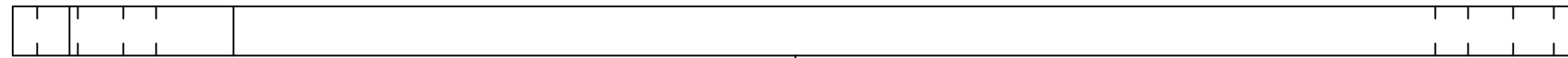

TOP

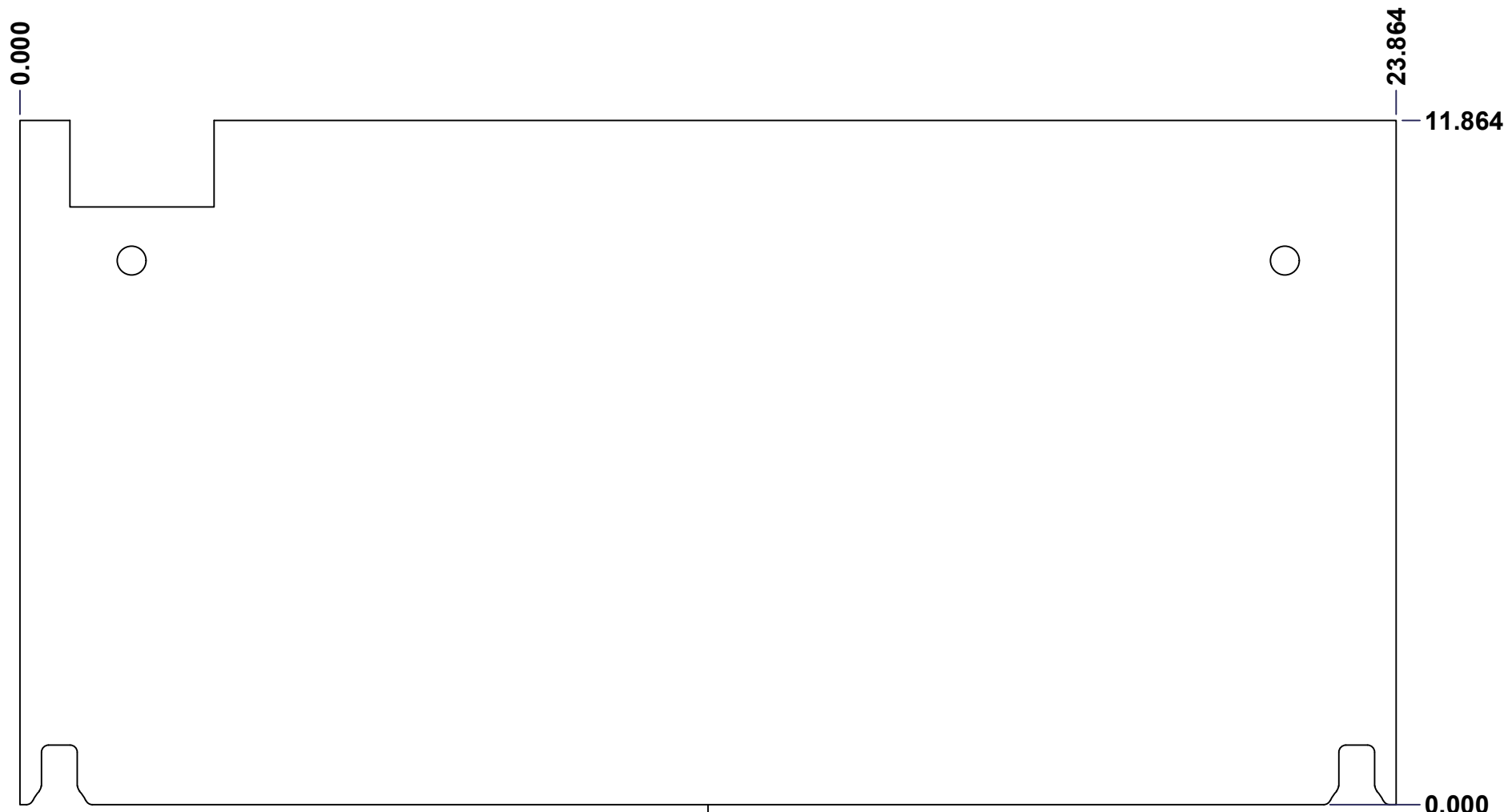

FRONT

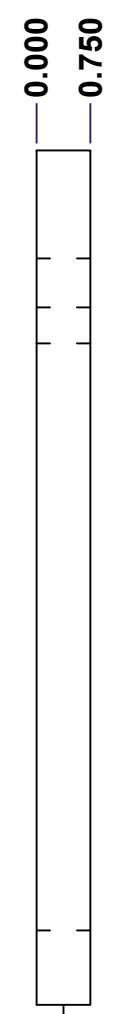

RIGHT

No.	Revisions	Date	By/Par

Isometric View

<p>Tél: (450) 979-4373 Fax: (450) 979-4626 www.exmweb.com</p>		Flatness Aplatissement
		Max 3.0mm
		Projection
Customer Client	Date	Date
Drawn By Dessiné Par	BoxCad: Patrick Deschenes	Date 23-Jan-07
Material Matière	Polyisocyanurate	
Color Couleur	Aluminum	Finish Fini N/A
Description	Detail Rev.	
5412ESS 42" x 24" Top and Bottom Insulation		
Part Number Numéro Pièce	Rev. 0	15 16

SEE BILL OF MATERIAL ON LAST PAGE 5412ESS422412THNOIPI-BT 0

This drawing is confidential and must not be reproduced or used without the consent of EXM

Ce dessin est confidentiel et ne doit pas être reproduit ou utilisé sans le consentement de EXM

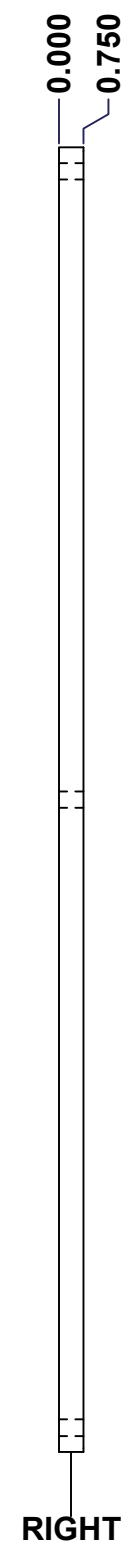
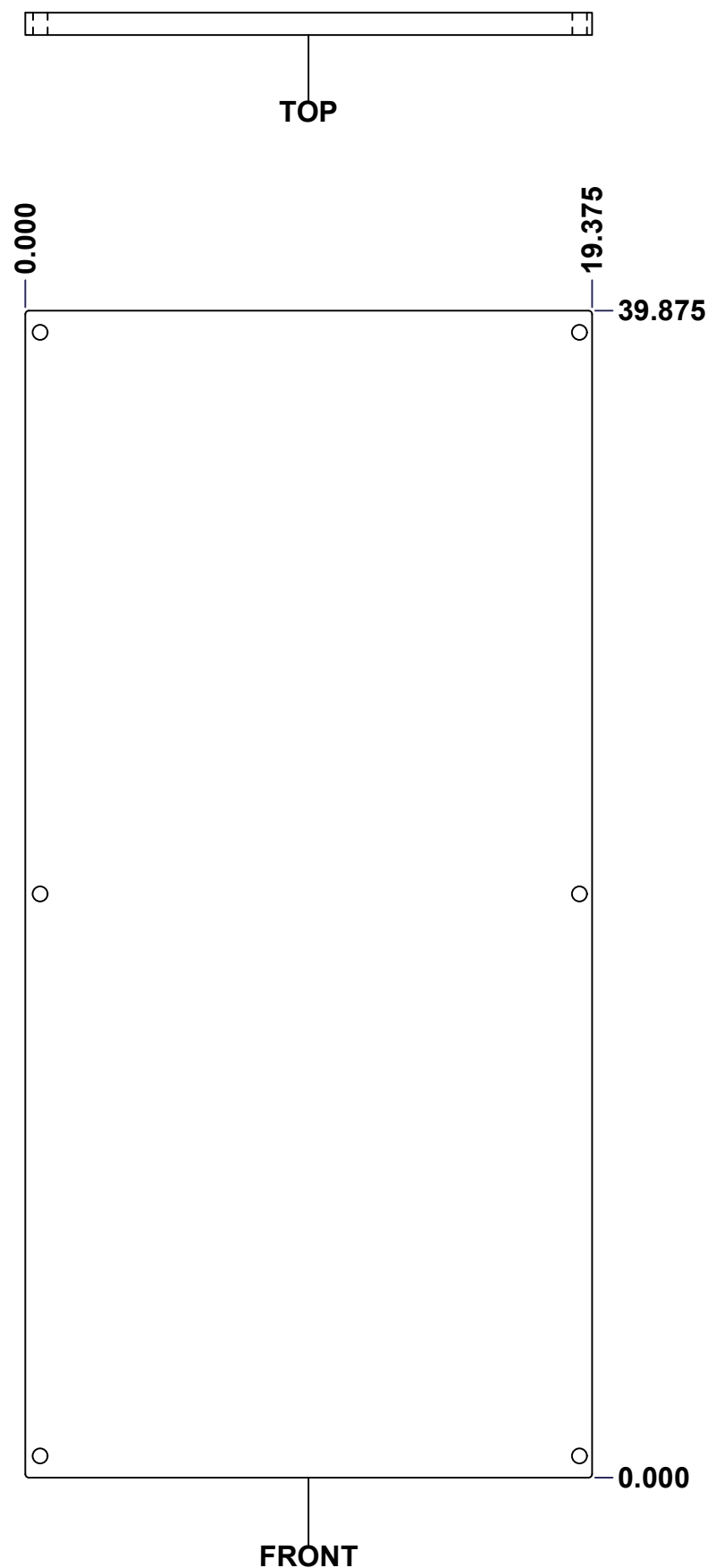

No.	Revisions	Date	By/Par

Isometric View

<p>Tél: (450) 979-4373 Fax: (450) 979-4626 www.exmweb.com</p>		Flatness Aplatissement	
		Max 3.0mm	
Customer Client		Date	
Drawn By Dessiné Par		Date	
Material Matière		Polyisocyanurate	
Color Couleur		Aluminum	Finish Fini
Description		Detail Rev.	
5412ESS 42" x 24" Cover Insulation			
Part Number Numéro Pièce		Rev.	16
5412ESS422412THNOIPI-C		0	16

SEE BILL OF MATERIAL ON LAST PAGE