

This drawing is confidential and must not be reproduced or used without the consent of EXM

Ce dessin est confidentiel et ne doit pas être reproduit ou utilisé sans le consentement de EXM

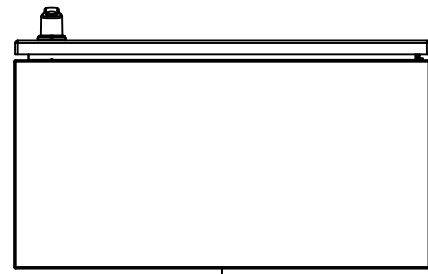

TOP

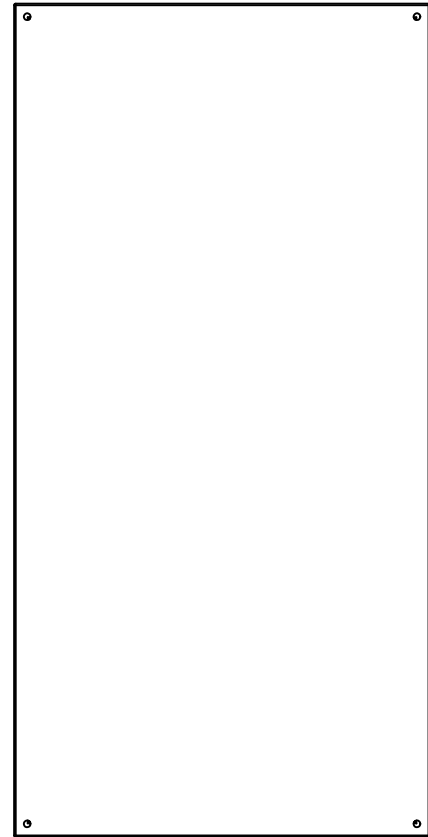

BACK

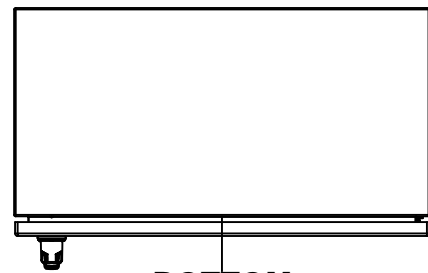

BOTTOM

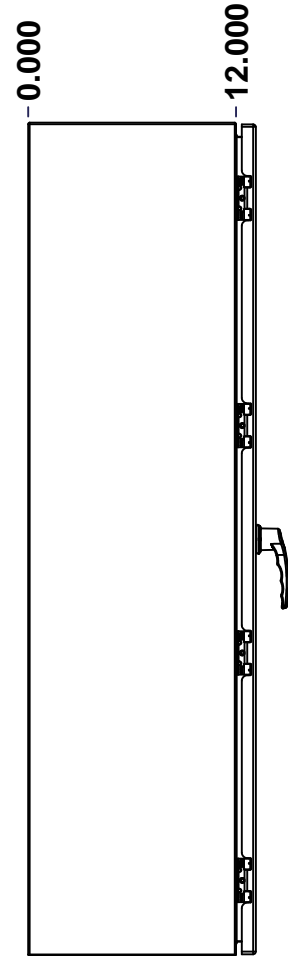

LEFT

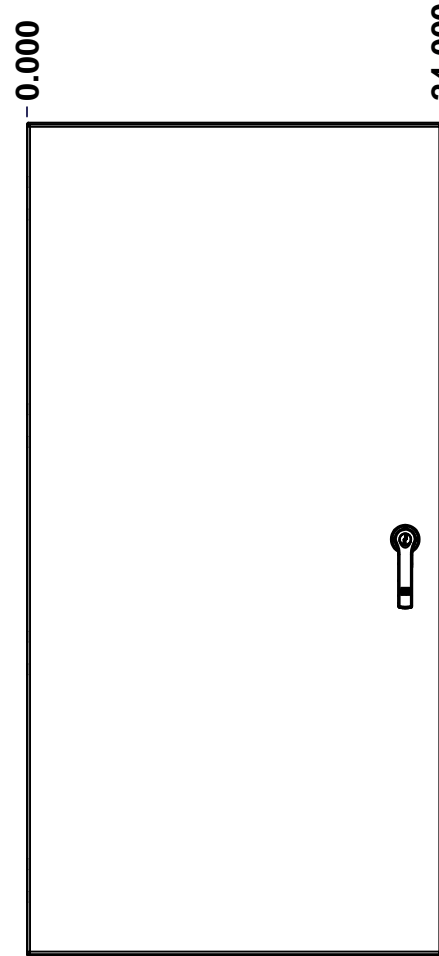

FRONT

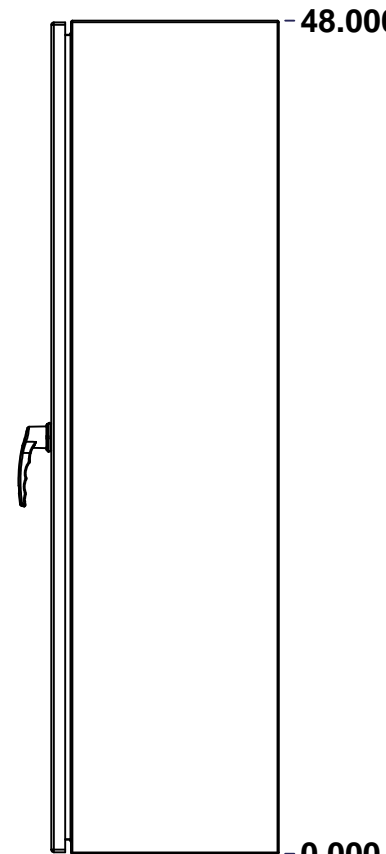

RIGHT

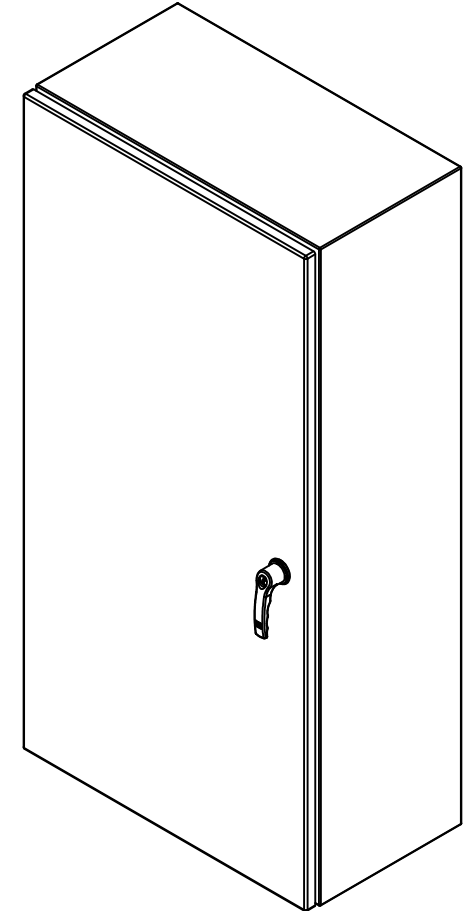

Isometric View



**GRAIN DIRECTION:
TOP/BOTTOM: HORIZONTAL
LEFT/RIGHT/BACK/FRONT: VERTICAL**

SEE BILL OF MATERIAL ON LAST PAGE

No.	Revisions	Date	By/Par

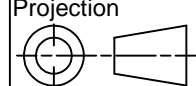
 Tél: (450) 979-4373 Fax: (450) 979-4626 www.exmweb.com		Flatness Aplatissement Max 3.0mm Projection 
Customer Client	Date	Date
Drawn By Dessiné Par	BoxCad: BoxCad	21-Oct-21
Material Matière	16 Ga Stainless Steel 316 (1.4mm)	
Color Couleur	Unpainted	Finish Fini Brushed
Description	Detail Rev.	
5412ESS 48" x 24" x 12" Assembly		
Part Number Numéro Pièce	Rev.	1
5412ESS4824126	0	2

This drawing is confidential and must not be reproduced or used without the consent of EXM

Ce dessin est confidentiel et ne doit pas être reproduit ou utilisé sans le consentement de EXM

NOTE	
ITEM	DESCRIPTION
1	NEMA 4X Enclosure
2	C/W Standard ground studs on box and cover
3	C/W Standard door stiffener
4	C/W Standard inner panel (Included)
5	C/W Standard inner panel mounting studs

No.	Revisions	Date	By/Par

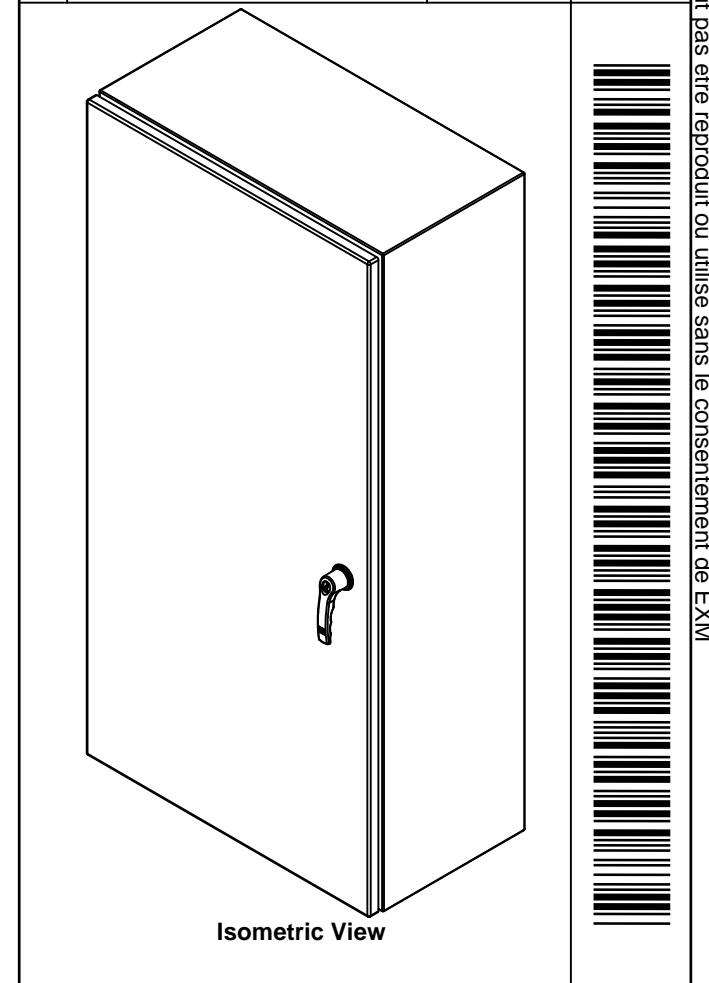

Tél: (450) 979-4373
Fax: (450) 979-4626
www.exmweb.com

Flatness
Aplatissement
Max 3.0mm
Projection

PACKING		
ITEM	QTY	DESCRIPTION
Cardboard sleeve	2	Top and Bottom
Cardboard strip	2	Between back of enclosure and inner panel
Plastic bag	1	To protect cover surface and inside gasket
Cardboard corner	4	To reinforced for the plastic strap tightening
Plastic strap - Black	2	To Squeeze the 2 cardboard sleeve together
Packaging label	3	White label with PN
Plastic strap- Green	2	To secure the enclosure to the wood pallet
Wood Pallet	1	2" deeper and 3" larger than enclosure size

1	880 PP	6	Self Adhesive Print Pocket
1	STK-K-01800	5	5412 ES Accessory Kit
1	881 SP4824G	0	881 SP - Inner Panel
1	5412ESS4824126C	0	5412ESS 48" x 24" Cover
6	STK-Q-07310	2	Flange Lock Nut M8
6	STK-Q-07610	8	M8 Plastic Spacer 22.2mm
1	5412ESS4824126B	0	5412ESS 48" x 24" x 12" Body
4	STK-Q-04051-07	8	M6 x 7mm Stainless Steel Hexagon Socket Head Machine Screw with Nyseal
Qty	Part Number	Rev	Description
Parts List			

Customer Client	Date
Drawn By Dessiné Par	Date 21-Oct-21
Material Matière	16 Ga Stainless Steel 316 (1.4mm)
Color Couleur	Unpainted
Finish Fini	Brushed
Description	Detail Rev.
5412ESS 48" x 24" x 12" Assembly	
Part Number Numéro Pièce	Rev.
5412ESS4824126	0
	2

This drawing is confidential and must not be reproduced or used without the consent of EXM

Ce dessin est confidentiel et ne doit pas être reproduit ou utilisé sans le consentement de EXM

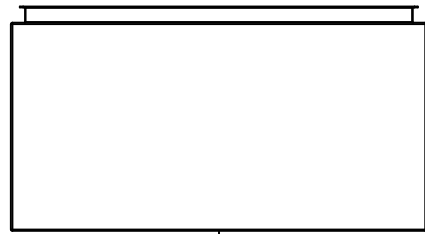

TOP

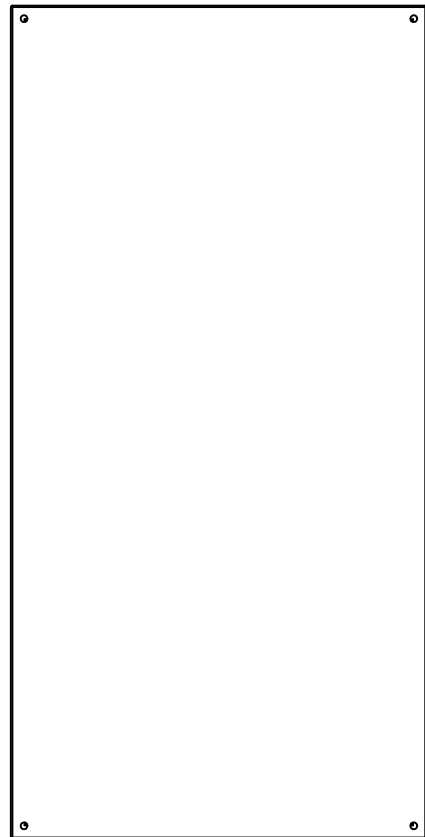

BACK

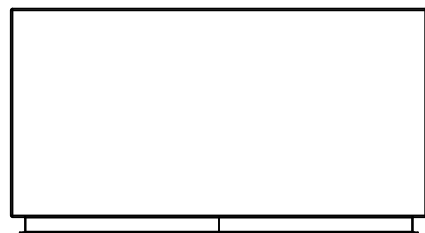

BOTTOM

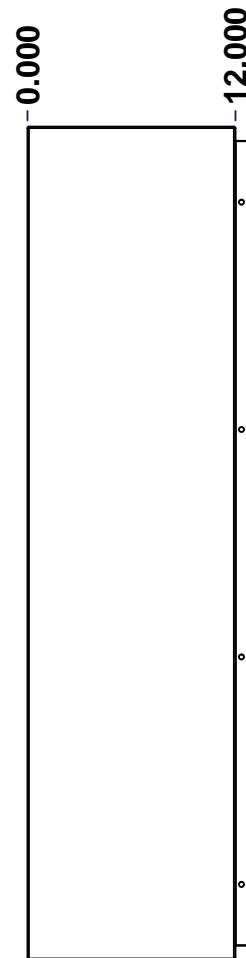

LEFT

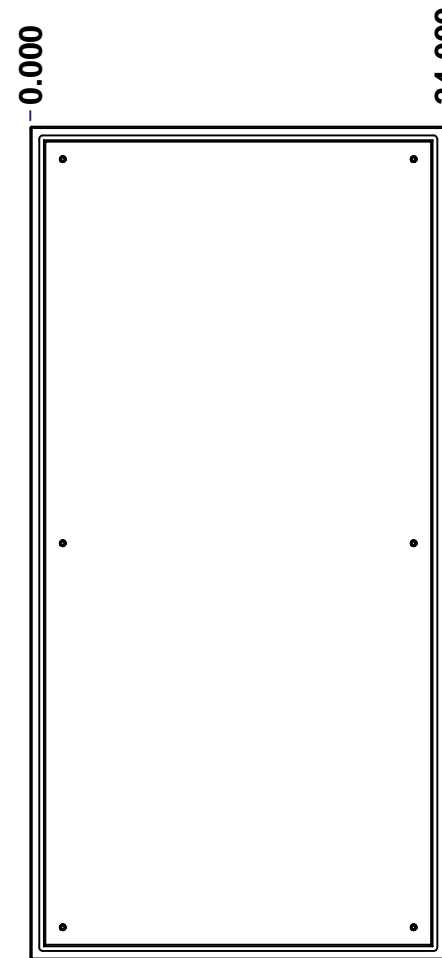

FRONT

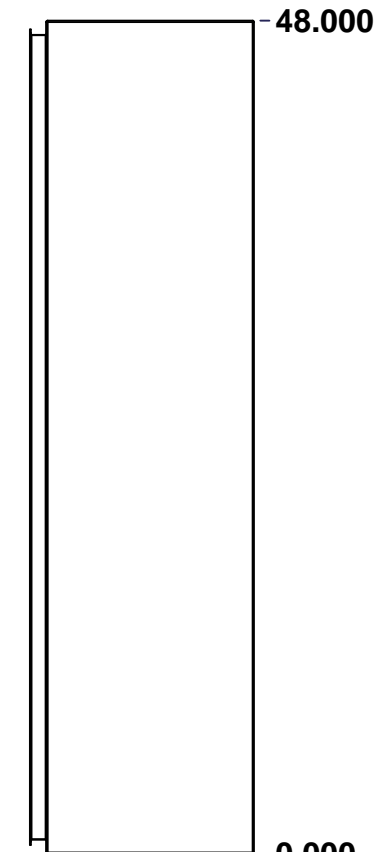

RIGHT

No.	Revisions	Date	By/Par

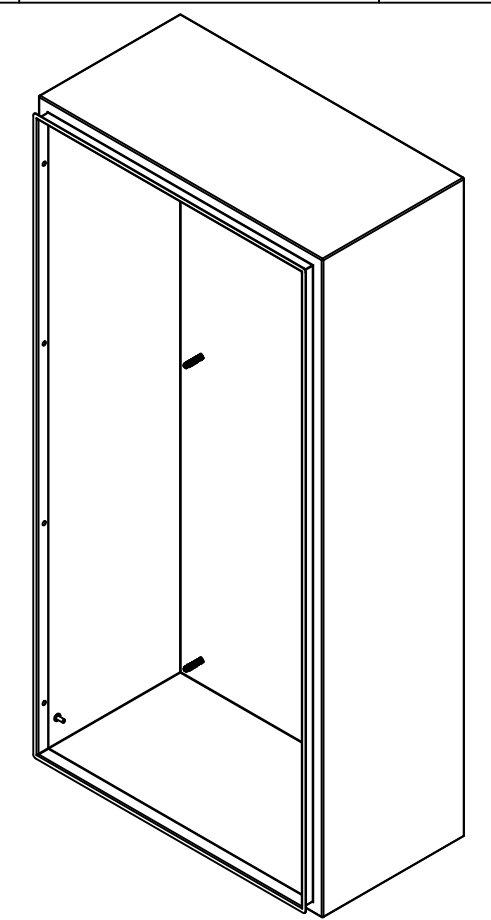

Isometric View

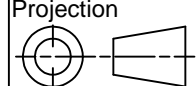

 Tél: (450) 979-4373 Fax: (450) 979-4626 www.exmweb.com		Flatness Aplatissement Max 3.0mm Projection 	
Customer Client		Date	
Drawn By / Dessiné Par: BoxCad: BoxCad		Date: 21-Oct-21	
Material / Matière: 16 Ga Stainless Steel 316 (1.4mm)			
Color / Couleur: Unpainted		Finish / Fini: Brushed	
Description: 5412ESS 48" x 24" x 12" Body			Detail Rev.
Part Number / Numéro Pièce: 5412ESS4824126B		Rev. 0	1 / 7

SEE BILL OF MATERIAL ON LAST PAGE

This drawing is confidential and must not be reproduced or used without the consent of EXM

Ce dessin est confidentiel et ne doit pas être reproduit ou utilisé sans le consentement de EXM

STANDARD FEATURES ARE NOT LISTED IN THIS HOLE TABLE			
HOLE TABLE - LEFT VIEW (CUSTOM FEATURE ONLY)			
CUT-OUT	XDIM	YDIM	DESCRIPTION
1	10.500	2.000	GND STUD M6 x 16mm (Inside)

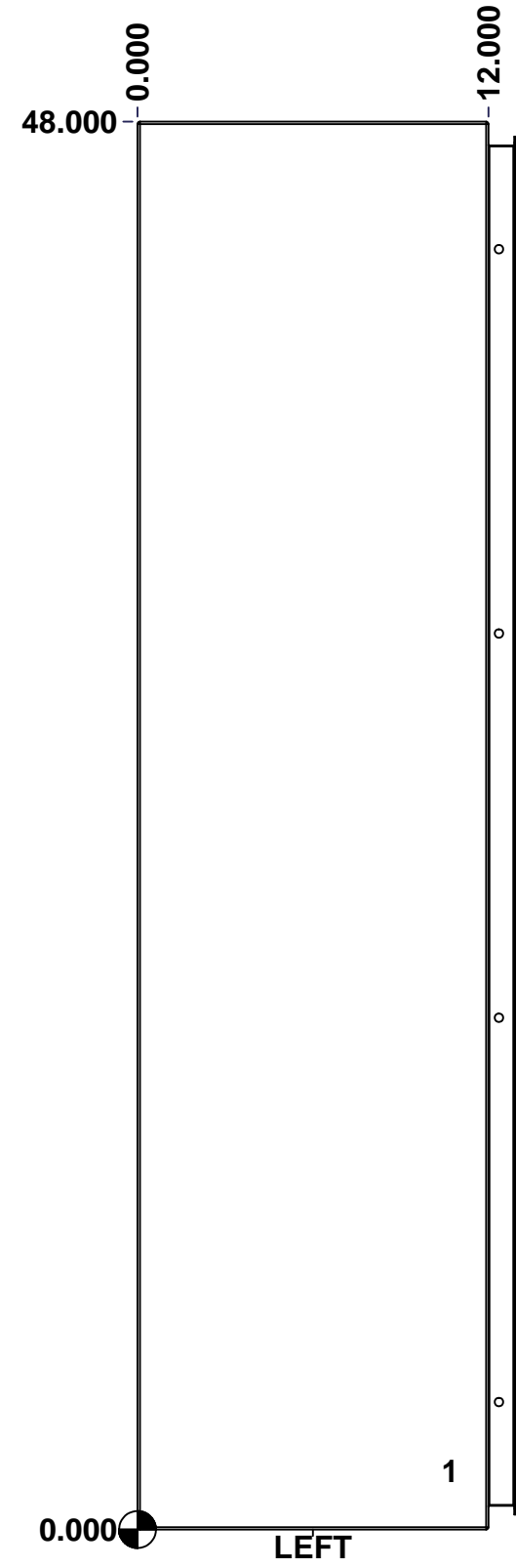

	Description	Status	
	5412ESS 48" x 24" x 12" Body		
	Part Number Numéro Pièce	Rev.	5 7
	5412ESS4824126B	0	

This drawing is confidential and must not be reproduced or used without the consent of EXM

Ce dessin est confidentiel et ne doit pas être reproduit ou utilisé sans le consentement de EXM

STANDARD FEATURES ARE NOT LISTED IN THIS HOLE TABLE

HOLE TABLE - BACK VIEW (CUSTOM FEATURE ONLY)

CUT-OUT	XDIM	YDIM	DESCRIPTION
1	1.875	1.875	IP STUD M8 x 35mm (Inside)
2	1.875	46.125	IP STUD M8 x 35mm (Inside)
3	22.125	46.125	IP STUD M8 x 35mm (Inside)
4	22.125	1.875	IP STUD M8 x 35mm (Inside)
5	1.875	24.000	IP STUD M8 x 35mm (Inside)
6	22.125	24.000	IP STUD M8 x 35mm (Inside)

7	23.250	0.750	RND Ø0.390
8	23.250	47.250	RND Ø0.390
9	0.750	47.250	RND Ø0.390
10	0.750	0.750	RND Ø0.390

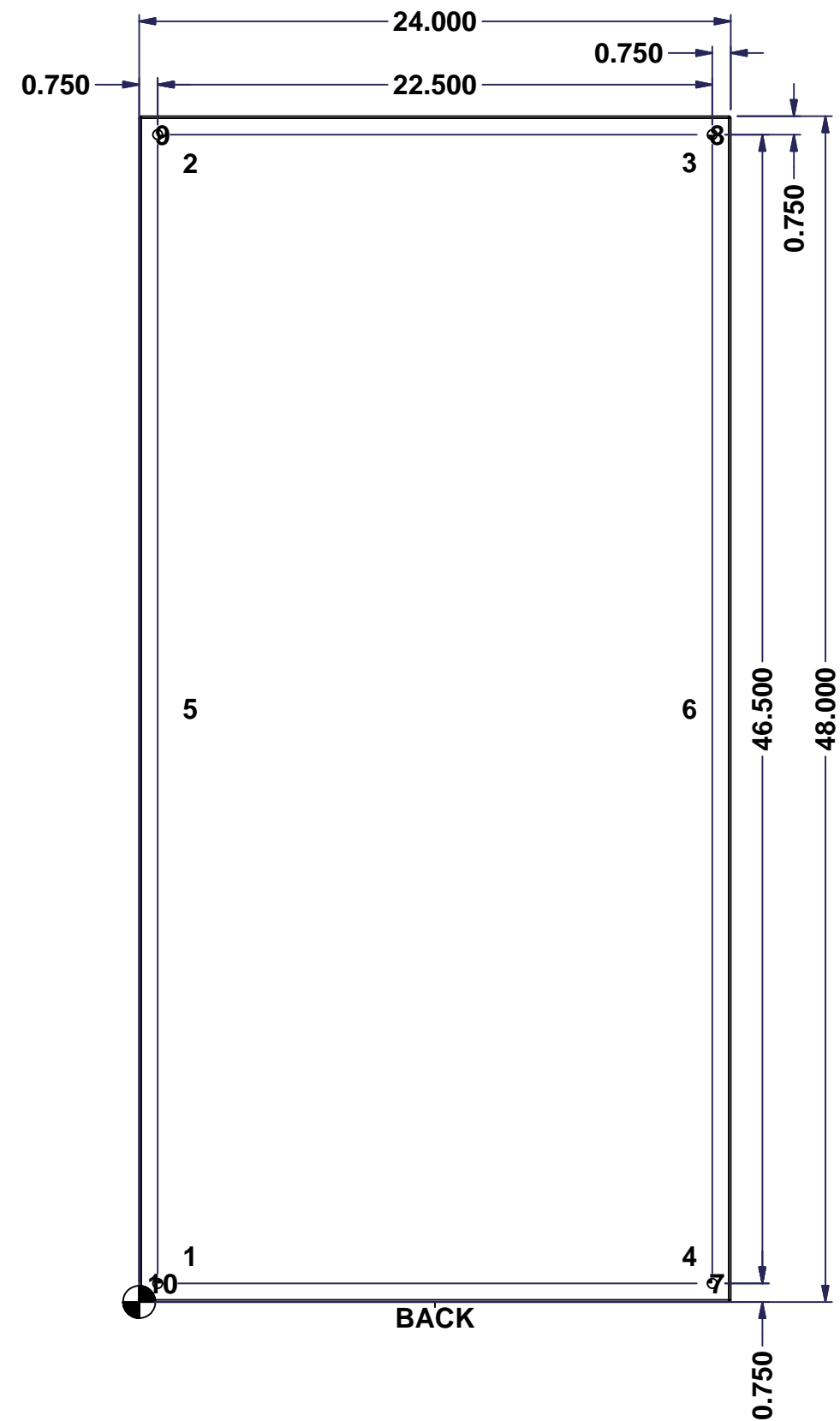



	Description	Status
	5412ESS 48" x 24" x 12" Body	
	Part Number Numéro Pièce	Rev.
	5412ESS4824126B	0
		6
		7

This drawing is confidential and must not be reproduced or used without the consent of EXM

Ce dessin est confidentiel et ne doit pas être reproduit ou utilisé sans le consentement de EXM

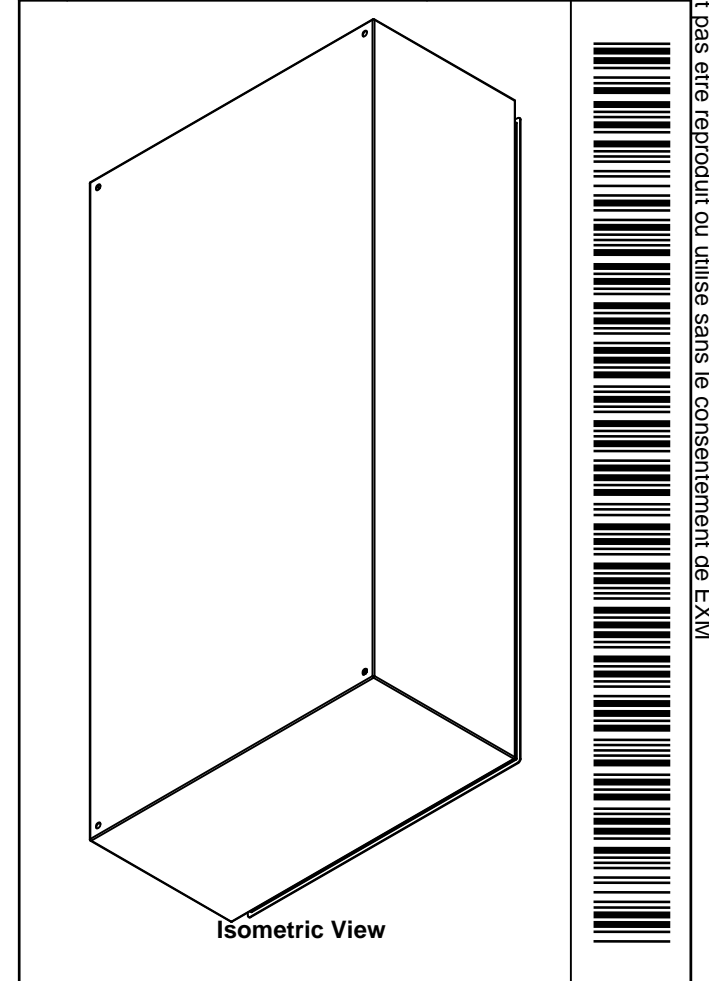
No.	Revisions	Date	By/Par

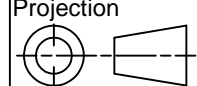

 Tél: (450) 979-4373 Fax: (450) 979-4626 www.exmweb.com		Flatness Aplatissement Max 3.0mm Projection 
Customer Client	Date	
Drawn By Dessiné Par	BoxCad: BoxCad	Date 21-Oct-21
Material Matière	16 Ga Stainless Steel 316 (1.4mm)	
Color Couleur	Unpainted	Finish Fini Brushed
Description	Detail Rev.	
5412ESS 48" x 24" x 12" Body		
Part Number Numéro Pièce	Rev.	7
5412ESS4824126B	0	7

Qty	Part Number	Rev	Description
1	STK-Q-16085	0	Ground Stud M6 x 16mm Stainless Steel
6	STK-Q-16020	1	Stud M8 x 35mm Stainless Steel
1	5412ESS4824126B-P	0	5412ESS 48" x 24" x 12" Body Part
Parts List			

This drawing is confidential and must not be reproduced or used without the consent of EXM

Ce dessin est confidentiel et ne doit pas être reproduit ou utilisé sans le consentement de EXM

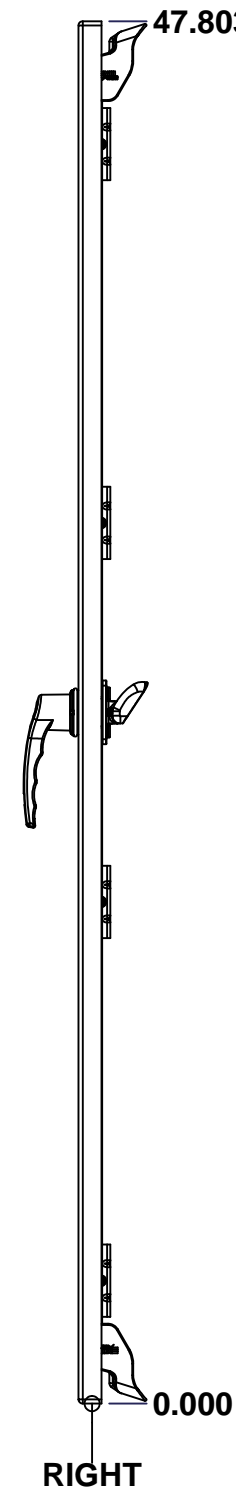
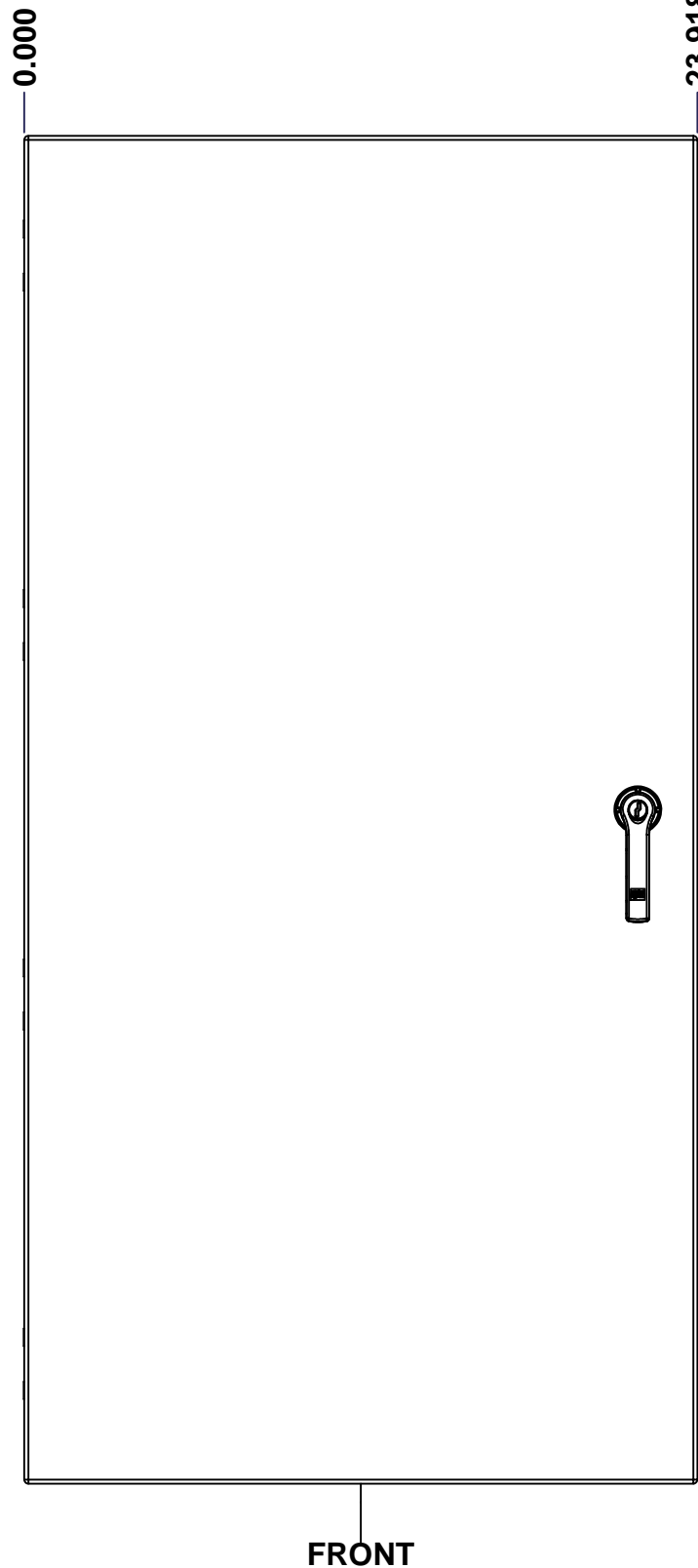
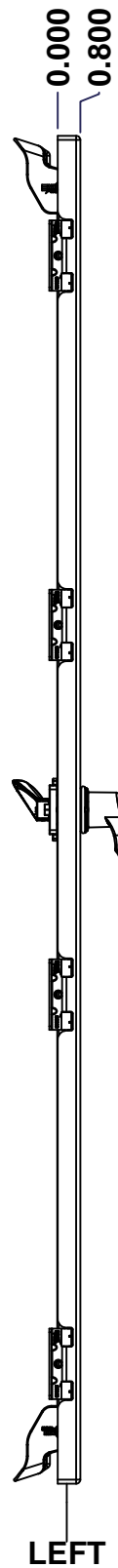
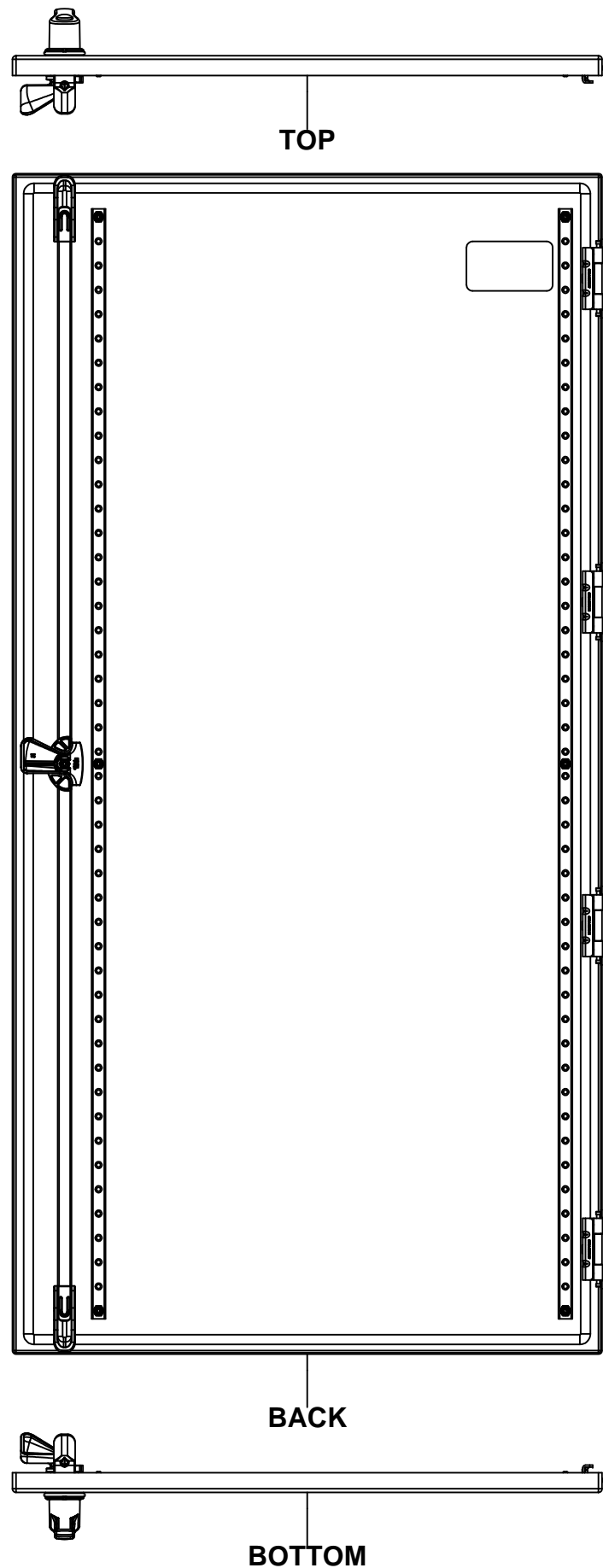

No.	Revisions	Date	By/Par

Isometric View

Tél: (450) 979-4373 Fax: (450) 979-4626 www.exmweb.com		Flatness Aplatissement	
		Max 3.0mm	
Customer Client		Projection	
Date			
Drawn By Dessiné Par	BoxCad: BoxCad	Date	21-Oct-21
Material Matière	16 Ga Stainless Steel 316 (1.4mm)		
Color Couleur	Unpainted	Finish Fini	Brushed
Description		Detail Rev.	
5412ESS 48" x 24" Cover			
Part Number Numéro Pièce	Rev.	1	3
SEE BILL OF MATERIAL ON LAST PAGE		0	
5412ESS4824126C			

This drawing is confidential and must not be reproduced or used without the consent of EXM

Ce dessin est confidentiel et ne doit pas être reproduit ou utilisé sans le consentement de EXM

STANDARD FEATURES ARE NOT LISTED IN THIS HOLE TABLE			
HOLE TABLE - FRONT VIEW (CUSTOM FEATURE ONLY)			
CUT-OUT	XDIM	YDIM	DESCRIPTION
1	1.486	1.756	STUD M6 x 18mm (Inside)
2	1.486	46.047	STUD M6 x 18mm (Inside)
3	20.423	46.047	STUD M6 x 18mm (Inside)
4	20.423	1.756	STUD M6 x 18mm (Inside)
5	1.486	23.902	STUD M6 x 18mm (Inside)
6	20.423	23.902	STUD M6 x 18mm (Inside)
7	21.803	42.896	CLOSING BAR STUD (Inside)
8	21.803	4.907	CLOSING BAR STUD (Inside)

9	3.750	44.053	LABEL_EXM (Inside)
10	21.803	23.902	HANDLE 885 ESL2A-LSS @ 0.0°

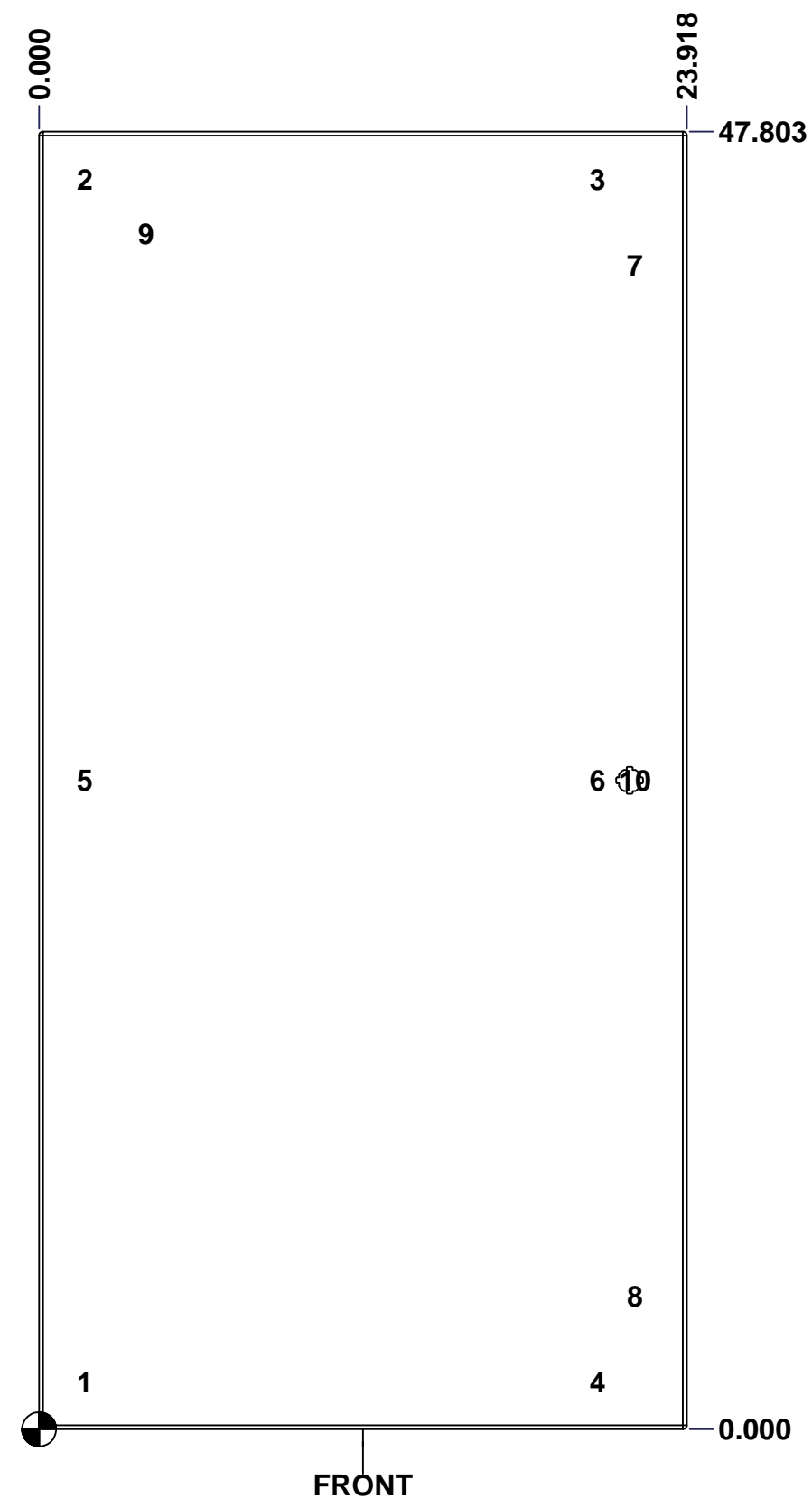

	Description	Status
	5412ESS 48" x 24" Cover	(NULL)
	Part Number Numéro Pièce	Rev.
	5412ESS4824126C	0
		2
		3

This drawing is confidential and must not be reproduced or used without the consent of EXM

Ce dessin est confidentiel et ne doit pas être reproduit ou utilisé sans le consentement de EXM

No.	Revisions	Date	By/Par

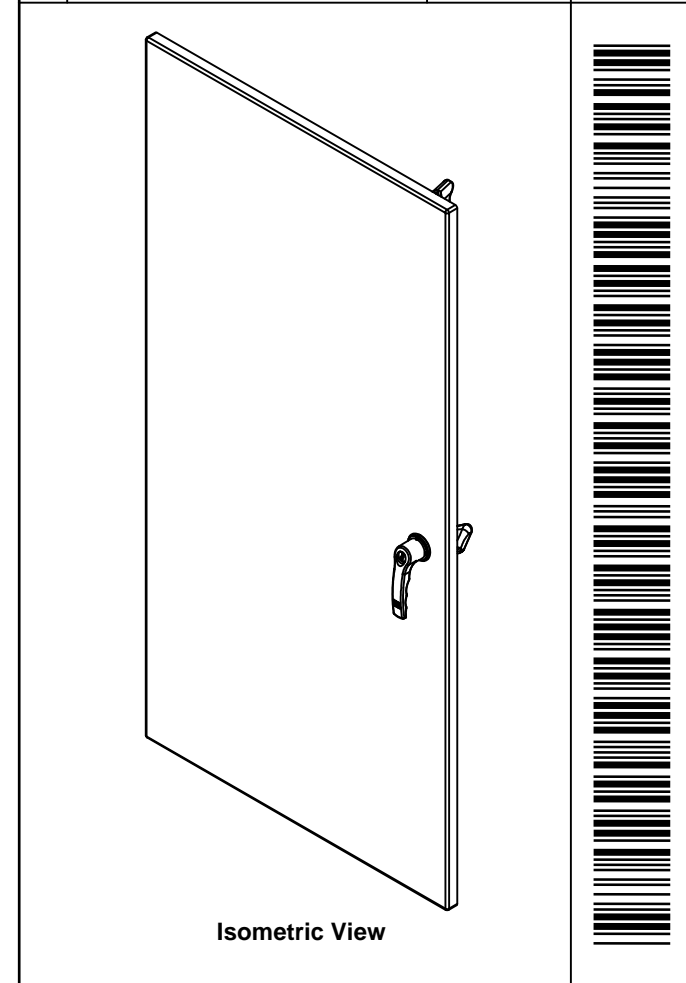

Qty	Part Name	Rev	Description
2	STK-Q-90042	4	5412 ES - Cabinet Closing Bar End (Small)
2	STK-Q-45655-48	0	5412 ES - Closing Bar
1	STK-Q-50536	13	5412 ES - Handle Cam Clockwise (Grip 32mm)
1	885 ESL2A-LSS	3	5412 ESS Key Lock L-Handle (3 Pts)
1	STK-S-00100	0	3.5" x 2" Silver Milar Flexcon Sticker
2	STK-Q-46020-48	5	5412 ES Vertical Door Stiffener 48"
2	STK-Q-16407	2	Guide Stud - Small (No Paint Cap Required)
6	STK-Q-16070	1	Stud M6 x 18mm Stainless steel
1	5412ESS4824126G	0	5412ESS 48" x 24" Cover Gasket Part
1	5412ESS4824126C-P	0	5412ESS 48" x 24" Cover Part
4	STK-A-33016	0	5412 ESS Bended Hinge (Body Part)
6	STK-Q-07220	1	M6 Nylon Insert Lock Nut

Parts List



Tél: (450) 979-4373
Fax: (450) 979-4626
www.exmweb.com

Flatness
Aplatissement
Max 3.0mm
Projection

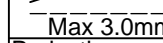
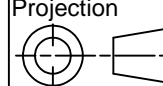
Customer Client		Date	
Drawn By Dessiné Par BoxCad: BoxCad		Date 21-Oct-21	
Material Matière 16 Ga Stainless Steel 316 (1.4mm)			
Color Couleur Unpainted	Finish Fini Brushed		
Description 5412ESS 48" x 24" Cover		Detail Rev.	
Part Number Numéro Pièce 5412ESS4824126C		Rev. 0	3

This drawing is confidential and must not be reproduced or used without the consent of EXM

Ce dessin est confidentiel et ne doit pas être reproduit ou utilisé sans le consentement de EXM

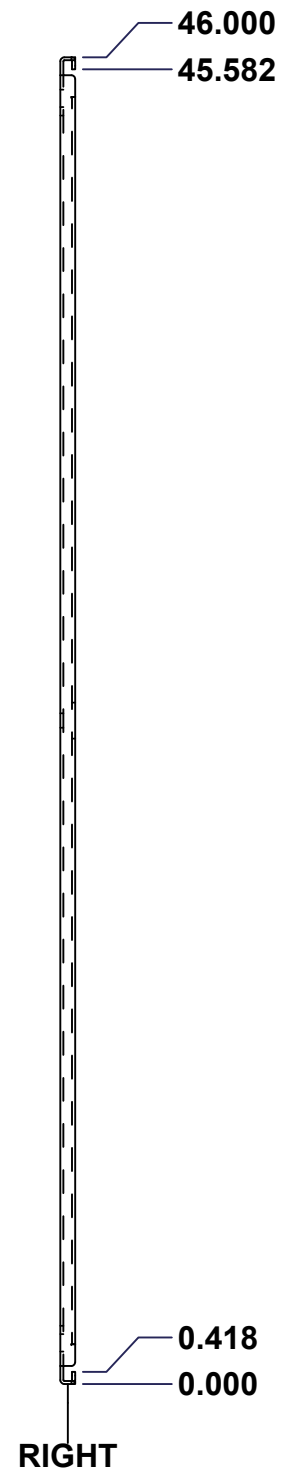
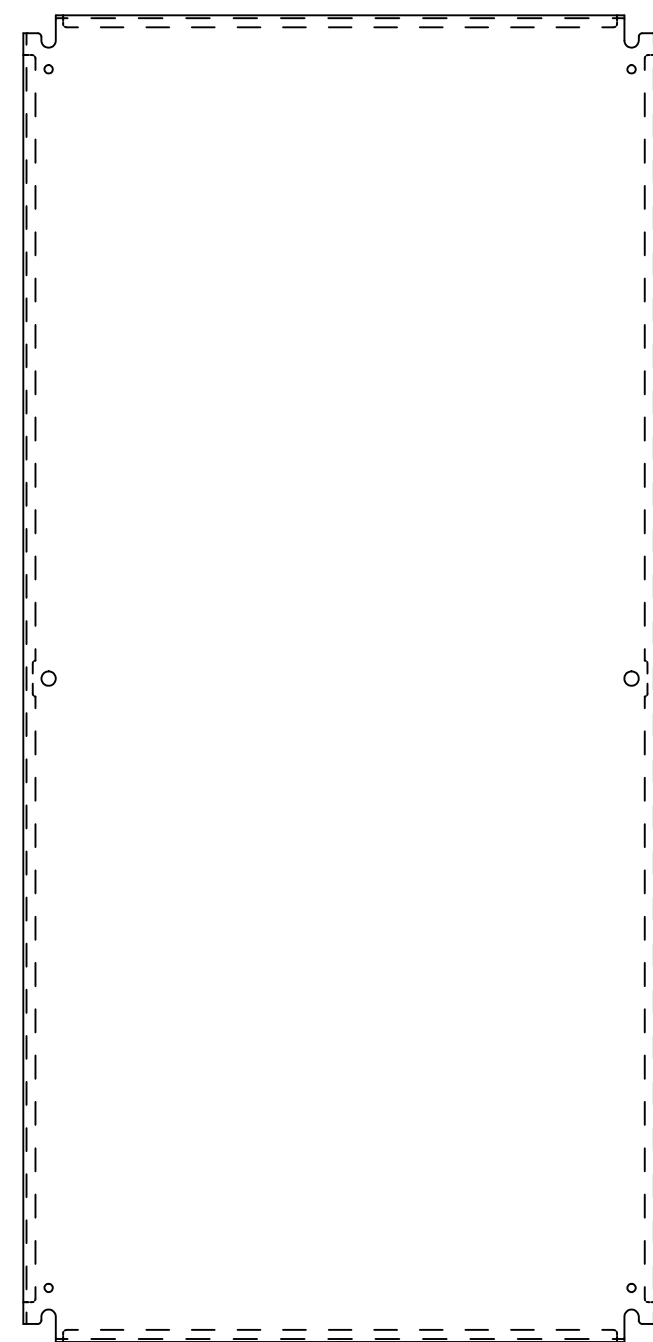
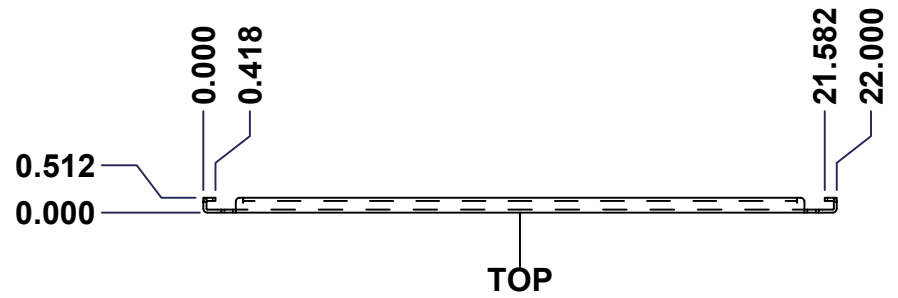

No.	Revisions	Date	By/Par

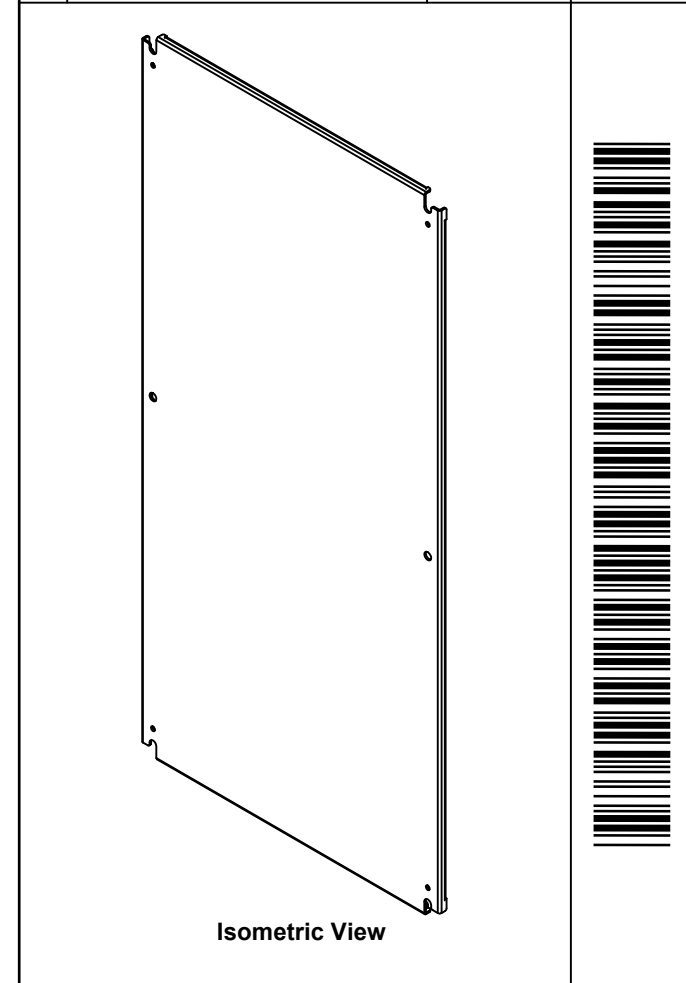

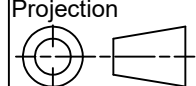
 Tél: (450) 979-4373 Fax: (450) 979-4626 www.exmweb.com		Flatness Aplatissement Max 3.0mm Projection 
Customer Client	Date	
Drawn By / Dessiné Par: BoxCad	Date: 1/23/2007	
Material / Matière	See Part List	
Color / Couleur	See Part List	Finish / Fini: See Part List
Description: 881 SP - Inner Panel		Detail Rev.
Part Number / Numéro Pièce: 881 SP4824G	Rev. 0	1/2

Qty	Part Number	Rev	Description	Material	Color	Finish
1	881 SP4824G-P	0	881 SP - Inner Panel Part	12 Ga Galvanized	Unpainted	Galvanized

Parts List

This drawing is confidential and must not be reproduced or used without the consent of EXM

Ce dessin est confidentiel et ne doit pas être reproduit ou utilisé sans le consentement de EXM

Table 1			FRONT VIEW
CUT-OUT	XDIM	YDIM	DESCRIPTION
1	0.875	1.875	GROUND HOLE (RND Ø0.290)
2	21.125	1.875	GROUND HOLE (RND Ø0.290)
3	0.875	44.125	GROUND HOLE (RND Ø0.290)
4	21.125	44.125	GROUND HOLE (RND Ø0.290)
5	0.875	23.000	MTG STUD HOLE (RND Ø0.500)
6	21.125	23.000	MTG STUD HOLE (RND Ø0.500)

All knockouts are actual size / Les disques défonçables sont grandeur réel

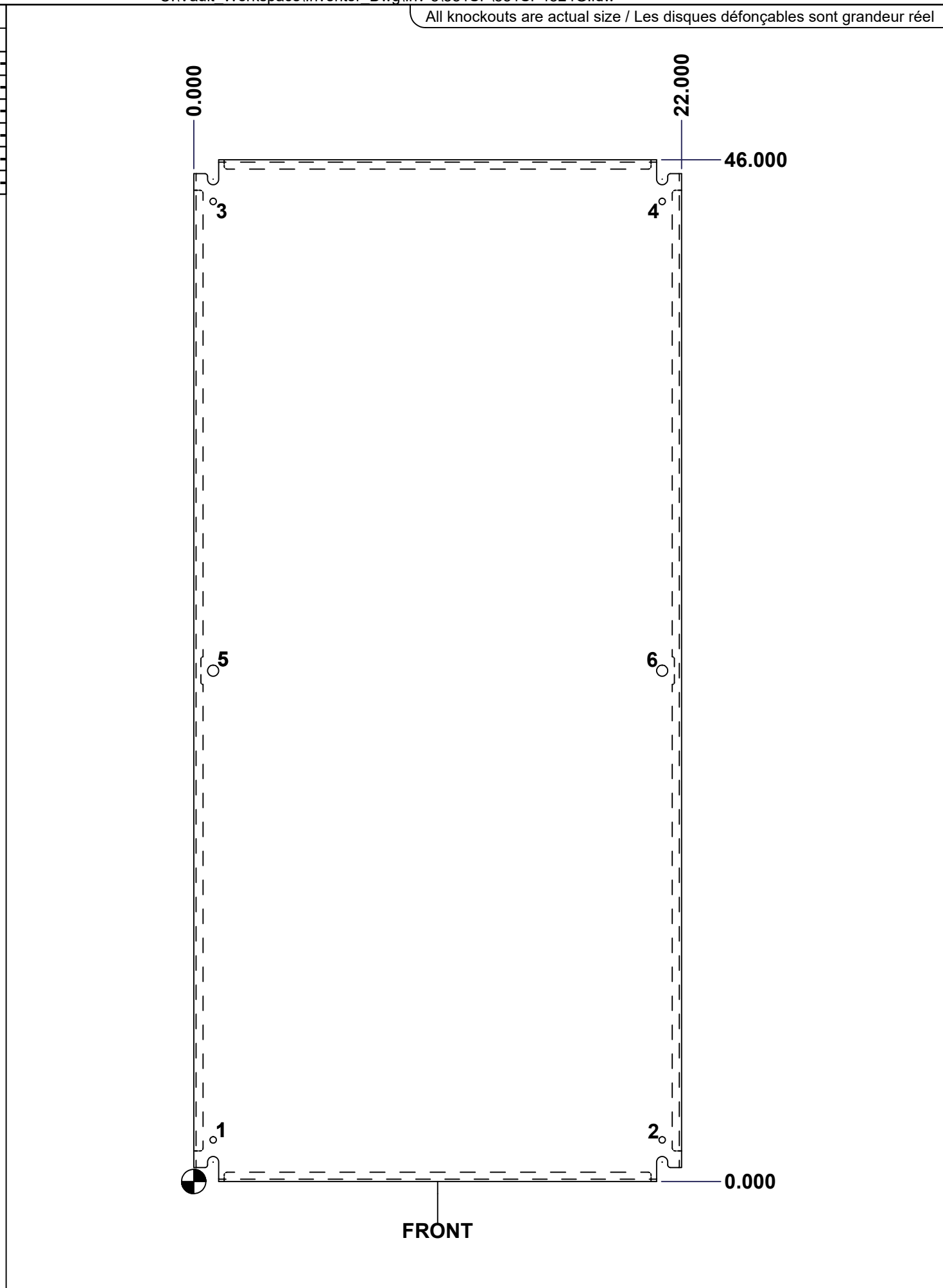

No.	Revisions	Date	By/Par

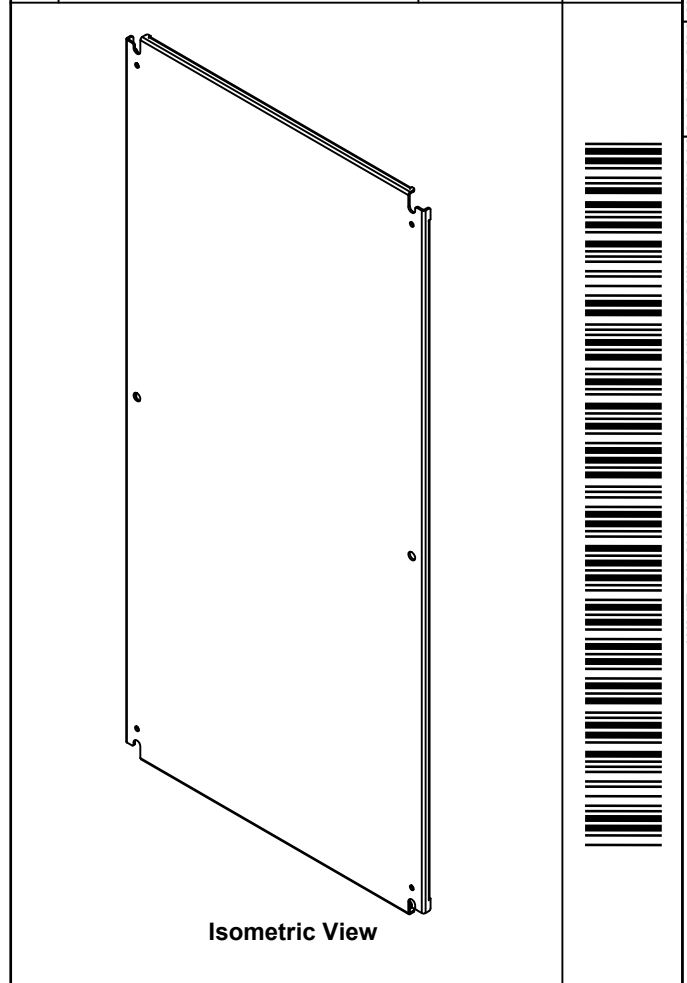

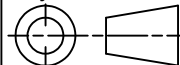
 Tél: (450) 979-4373 Fax: (450) 979-4626 www.exmweb.com	Flatness Aplatissement Max 3.0mm
	Projection 
Customer Client	Date
Drawn By Dessiné Par BoxCad	Date 1/23/2007
Material Matière See Part List	
Color Couleur See Part List	Finish Fini See Part List
Description 881 SP - Inner Panel	
Detail Rev.	
Part Number Numéro Pièce 881 SP4824G	Rev. 2 0