

This drawing is confidential and must not be reproduced or used without the consent of EXM

Ce dessin est confidentiel et ne doit pas être reproduit ou utilisé sans le consentement de EXM

| No. | Revisions | Date | By/Par |
|-----|-----------|------|--------|
|     |           |      |        |
|     |           |      |        |
|     |           |      |        |
|     |           |      |        |
|     |           |      |        |

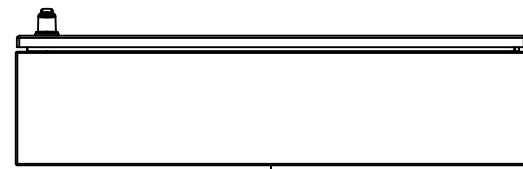

TOP

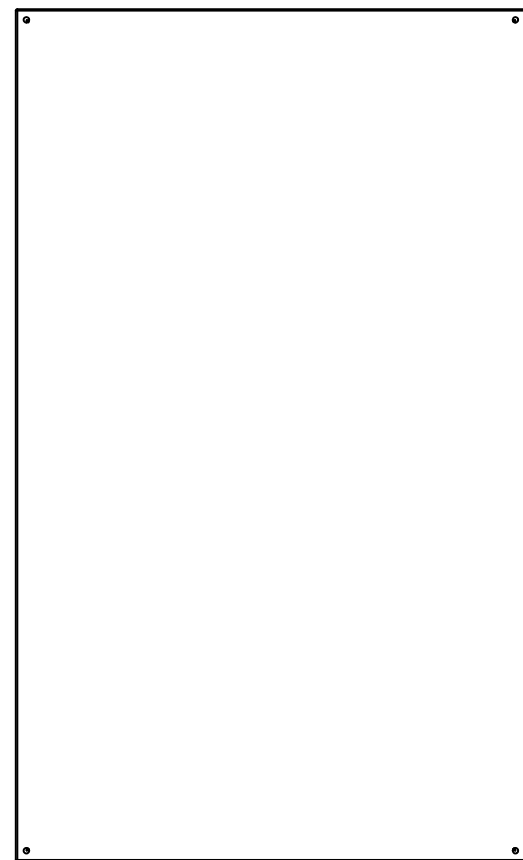

BACK

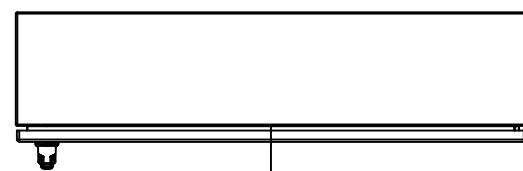

BOTTOM

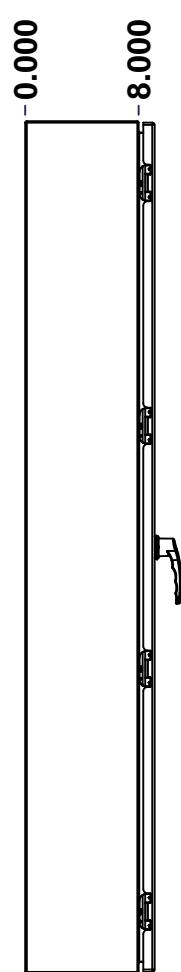

LEFT

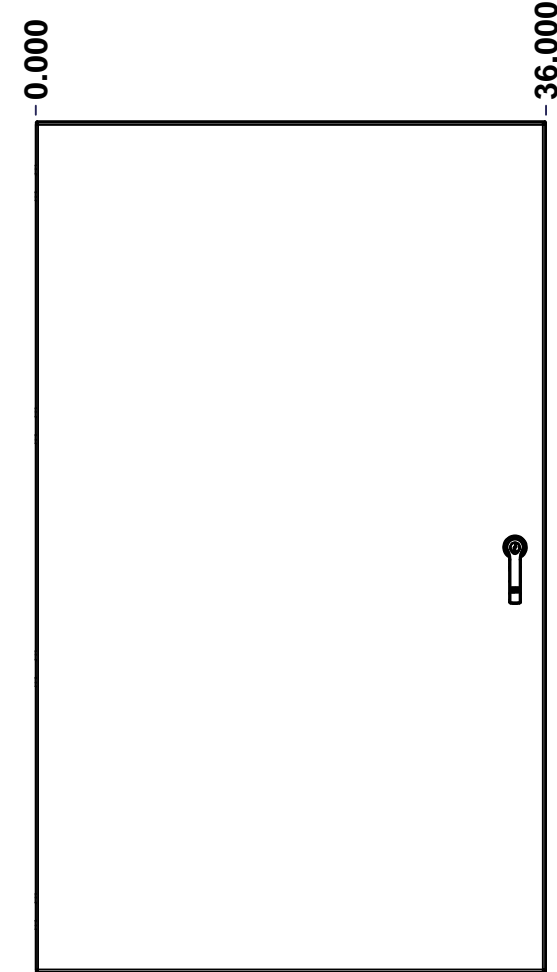

FRONT

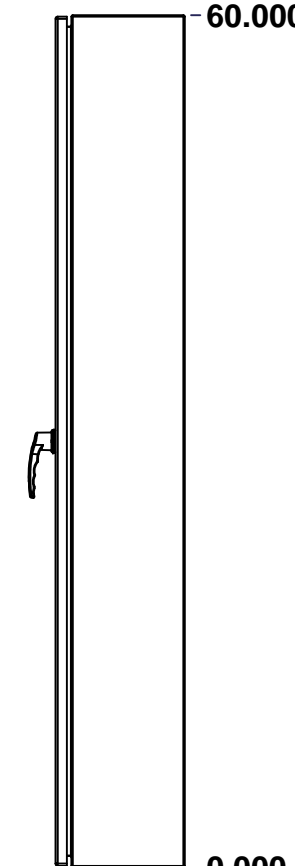

RIGHT

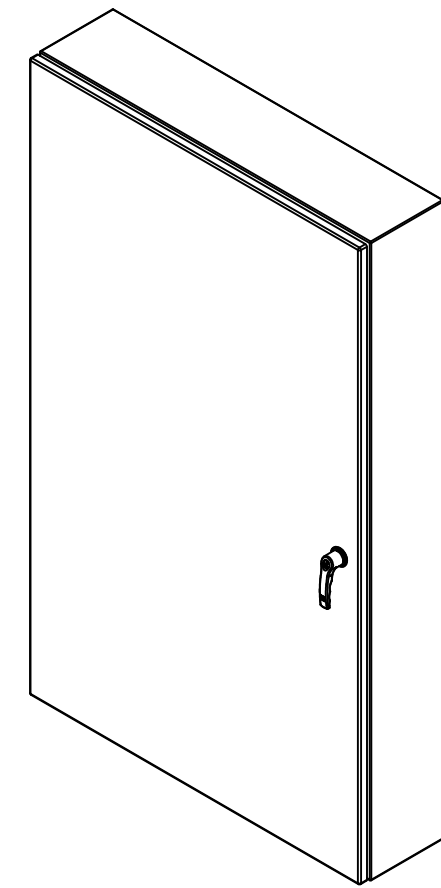

Isometric View



**GRAIN DIRECTION:  
TOP/BOTTOM: HORIZONTAL  
LEFT/RIGHT/BACK/FRONT: VERTICAL**

SEE BILL OF MATERIAL ON LAST PAGE

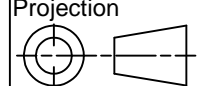
|  |                                   |   |
|--|-----------------------------------|---|
|  Tél: (450) 979-4373<br>Fax: (450) 979-4626<br><a href="http://www.exmweb.com">www.exmweb.com</a> |                                   | Flatness<br>Aplatissement<br>Max 3.0mm<br>Projection<br> |
| Customer Client  | Date                              |   |
| Drawn By<br>Dessiné Par  | BoxCad: BoxCad                    | Date 08-Feb-14  |
| Material<br>Matière  | 14 Ga Stainless Steel 304 (1.7mm) |   |
| Color<br>Couleur   | Unpainted                         | Finish<br>Fini Brushed  |
| Description  | Detail Rev.                       |   |
| 5412ESS 60" x 36" x 8" Assembly  |                                   |   |
| Part Number<br>Numéro Pièce  | Rev. 0                            | 1<br>2  |
| 5412ESS603608  |                                   |   |

This drawing is confidential and must not be reproduced or used without the consent of EXM

Ce dessin est confidentiel et ne doit pas être reproduit ou utilisé sans le consentement de EXM

| NOTE |  |
|------|--|
| ITEM | DESCRIPTION                                |
| 1    | NEMA 4X Enclosure                          |
| 2    | C/W Standard ground studs on box and cover |
| 3    | C/W Standard door stiffener                |
| 4    | C/W Standard inner panel (Included)        |
| 5    | C/W Standard inner panel mounting studs    |

| No. | Revisions | Date | By/Par |
|-----|-----------|------|--------|
|     |           |      |        |
|     |           |      |        |
|     |           |      |        |
|     |           |      |        |
|     |           |      |        |
|     |           |      |        |

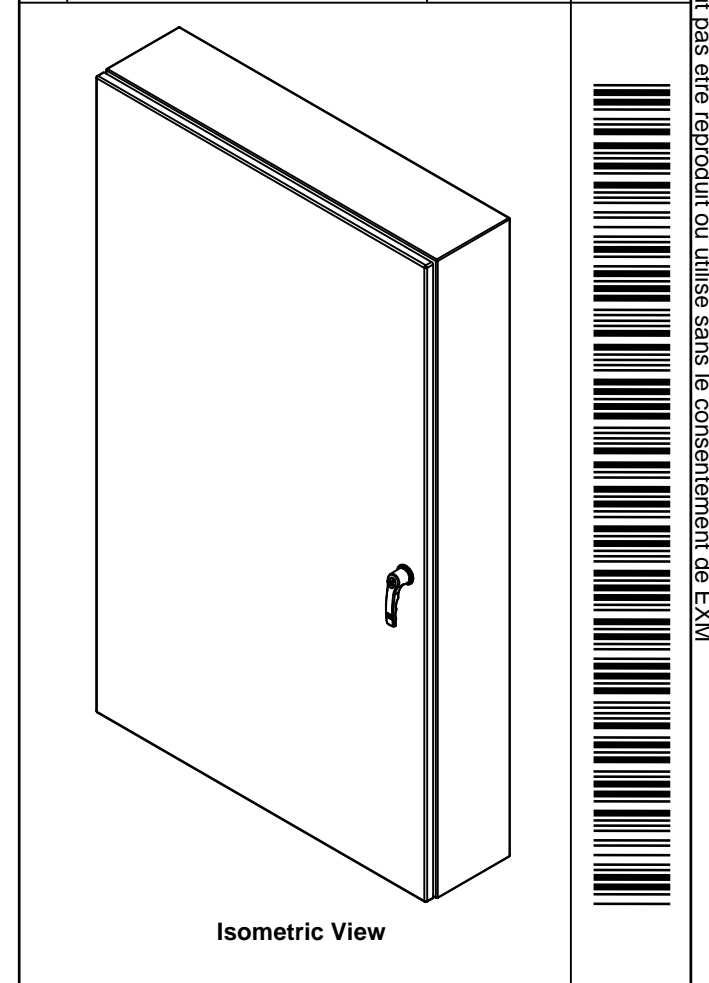

**EXM**  
www.exm.com

Tél: (450) 979-4373  
Fax: (450) 979-4626  
[www.exmweb.com](http://www.exmweb.com)

Flatness  
Aplatissement  
Max 3.0mm  
Projection

|  |                                   |
|--|-----------------------------------|
| Customer Client                        | Date                              |
| Drawn By<br>Dessiné Par BoxCad: BoxCad | Date 08-Feb-14                    |
| Material<br>Matière                    | 14 Ga Stainless Steel 304 (1.7mm) |

|                             |                                 |                |          |
|-----------------------------|---------------------------------|----------------|----------|
| Color<br>Couleur            | Unpainted                       | Finish<br>Fini | Brushed  |
| Description                 | 5412ESS 60" x 36" x 8" Assembly |                |          |
| Part Number<br>Numéro Pièce | <b>5412ESS603608</b>            |                | Rev. 2   |
|                             |                                 |                | <b>0</b> |

| PACKING               |     |  |
|-----------------------|-----|--|
| ITEM                  | QTY | DESCRIPTION                                    |
| Cardboard sleeve      | 2   | Top and Bottom                                 |
| Cardboard strip       | 2   | Between back of enclosure and inner panel      |
| Plastic bag           | 1   | To protect cover surface and inside gasket     |
| Cardboard corner      | 4   | To reinforced for the plastic strap tightening |
| Plastic strap - Black | 2   | To Squeeze the 2 cardboard sleeve together     |
| Packaging label       | 3   | White label with PN                            |
| Plastic strap- Green  | 2   | To secure the enclosure to the wood pallet     |
| Wood Pallet           | 1   | 2" deeper and 3" larger than enclosure size    |

|            |                |     |  |
|------------|----------------|-----|--|
| 1          | 880 PP         | 6   | Self Adhesive Print Pocket   |
| 1          | STK-K-01800    | 5   | 5412 ES Accessory Kit  |
| 1          | 881 SP6036G    | 0   | 881 SP - Inner Panel   |
| 1          | 5412ESS603608C | 0   | 5412ESS 60" x 36" Cover  |
| 8          | STK-Q-07310    | 2   | Flange Lock Nut M8   |
| 8          | STK-Q-07610    | 8   | M8 Plastic Spacer 22.2mm   |
| 1          | 5412ESS603608B | 0   | 5412ESS 60" x 36" x 8" Body  |
| 4          | STK-Q-04051-07 | 8   | M6 x 7mm Stainless Steel Hexagon Socket Head Machine Screw with Nyseal |
| Qty        | Part Number    | Rev | Description  |
| Parts List |                |     |  |

This drawing is confidential and must not be reproduced or used without the consent of EXM

Ce dessin est confidentiel et ne doit pas être reproduit ou utilisé sans le consentement de EXM



TOP

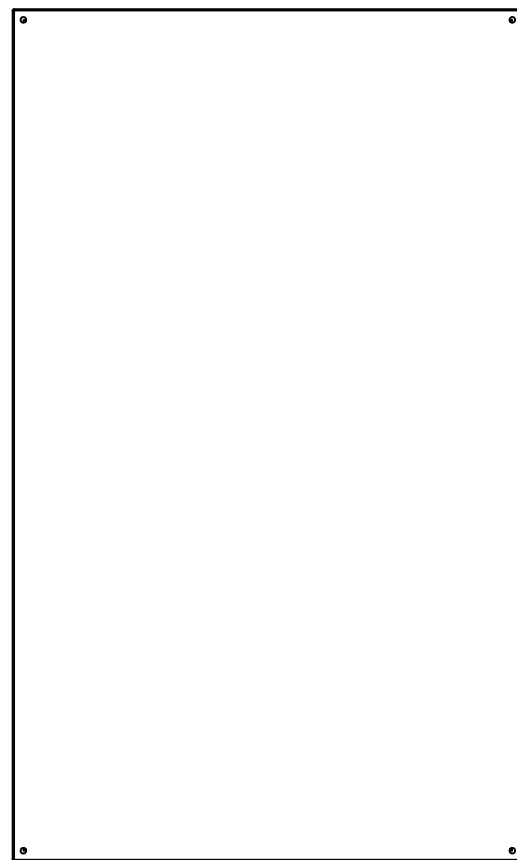

BACK

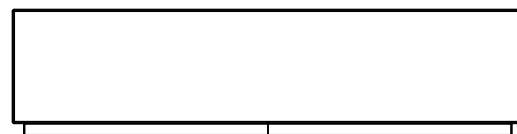

BOTTOM

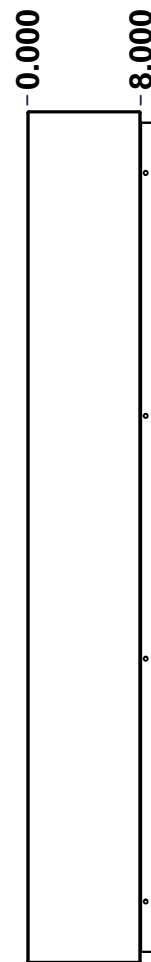

LEFT

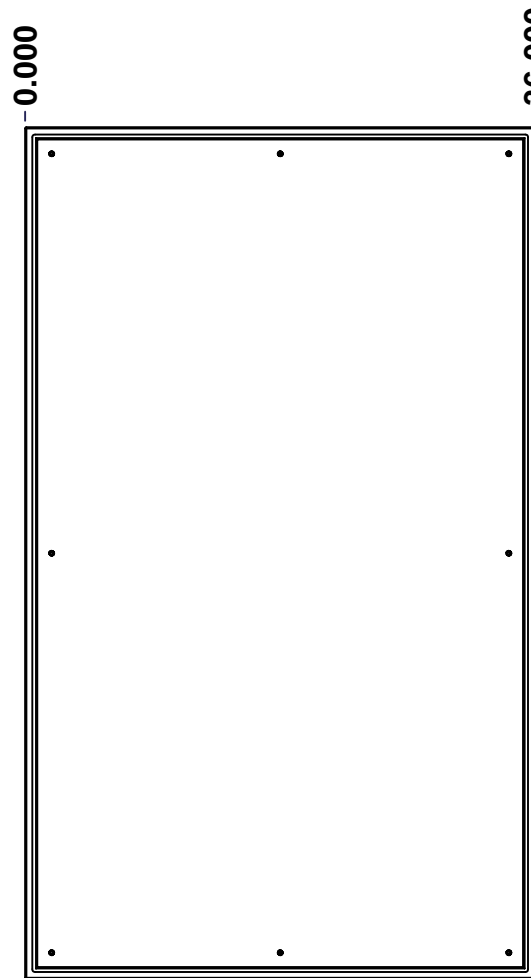

FRONT

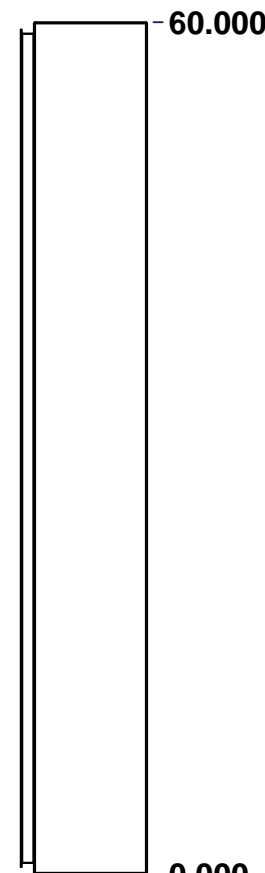

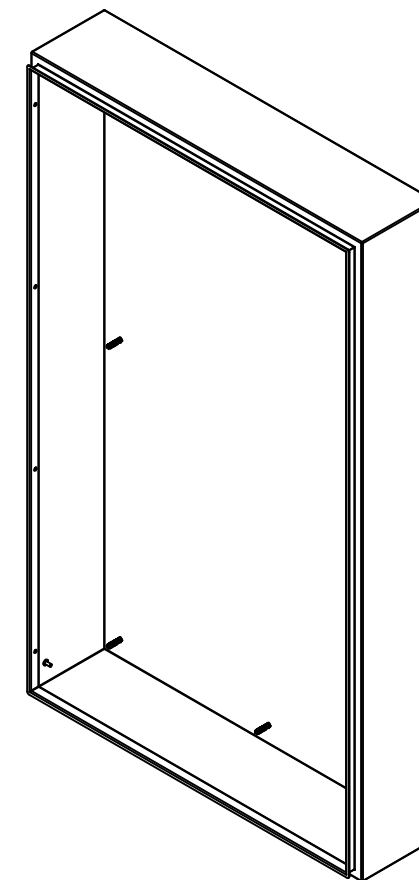

RIGHT



Isometric View



| No. | Revisions | Date | By/Par |
|-----|-----------|------|--------|
|     |           |      |        |
|     |           |      |        |
|     |           |      |        |
|     |           |      |        |
|     |           |      |        |

|  |                                   |   |
|--|-----------------------------------|---|
|  Tél: (450) 979-4373<br>Fax: (450) 979-4626<br><a href="http://www.exmweb.com">www.exmweb.com</a> |                                   | Flatness<br>Aplatissement<br>Max 3.0mm<br>Projection<br> |
| Customer Client  | Date                              |   |
| Drawn By<br>Dessiné Par  | BoxCad: BoxCad                    | Date 08-Feb-14  |
| Material<br>Matière  | 14 Ga Stainless Steel 304 (1.7mm) |   |
| Color<br>Couleur   | Unpainted                         | Finish<br>Fini Brushed  |
| Description  | Detail Rev.                       |   |
| 5412ESS 60" x 36" x 8" Body  |                                   |   |
| Part Number<br>Numéro Pièce  | Rev. 0                            | 1 / 7   |
| <b>5412ESS603608B</b>  |                                   |   |

SEE BILL OF MATERIAL ON LAST PAGE

This drawing is confidential and must not be reproduced or used without the consent of EXM

Ce dessin est confidentiel et ne doit pas être reproduit ou utilisé sans le consentement de EXM

| <b>STANDARD FEATURES ARE NOT LISTED IN THIS HOLE TABLE</b> |       |       |                             |
|--|-------|-------|-----------------------------|
| <b>HOLE TABLE - LEFT VIEW (CUSTOM FEATURE ONLY)</b>        |       |       |                             |
| CUT-OUT  | XDIM  | YDIM  | DESCRIPTION                 |
| 1  | 6.500 | 2.000 | GND STUD M6 x 16mm (Inside) |

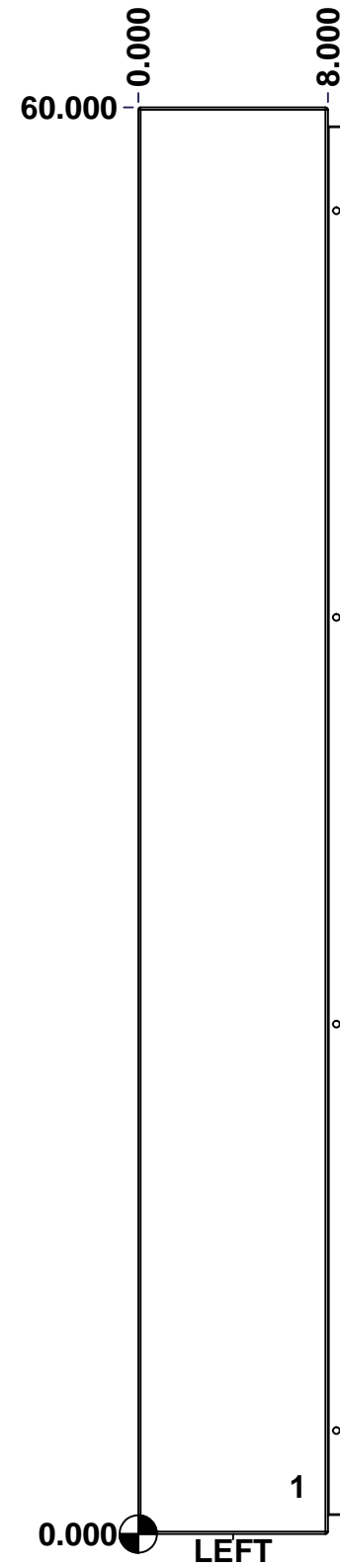

|  |                             |          |
|--|-----------------------------|----------|
|  | Description                 | Status   |
|  | 5412ESS 60" x 36" x 8" Body |          |
|  | Part Number<br>Numéro Pièce | Rev.     |
|  | <b>5412ESS603608B</b>       | <b>0</b> |
|  |                             | 5        |
|  |                             | 7        |

This drawing is confidential and must not be reproduced or used without the consent of EXM

Ce dessin est confidentiel et ne doit pas être reproduit ou utilisé sans le consentement de EXM

**STANDARD FEATURES ARE NOT LISTED IN THIS HOLE TABLE**

**HOLE TABLE - BACK VIEW (CUSTOM FEATURE ONLY)**

| CUT-OUT | XDIM   | YDIM   | DESCRIPTION                |
|---------|--------|--------|----------------------------|
| 1       | 1.875  | 1.875  | IP STUD M8 x 35mm (Inside) |
| 2       | 1.875  | 58.125 | IP STUD M8 x 35mm (Inside) |
| 3       | 34.125 | 58.125 | IP STUD M8 x 35mm (Inside) |
| 4       | 34.125 | 1.875  | IP STUD M8 x 35mm (Inside) |
| 5       | 1.875  | 30.000 | IP STUD M8 x 35mm (Inside) |
| 6       | 34.125 | 30.000 | IP STUD M8 x 35mm (Inside) |
| 7       | 18.000 | 1.875  | IP STUD M8 x 35mm (Inside) |
| 8       | 18.000 | 58.125 | IP STUD M8 x 35mm (Inside) |
| -----   |        |        |                            |
| 9       | 35.250 | 0.750  | RND Ø0.390                 |
| 10      | 35.250 | 59.250 | RND Ø0.390                 |
| 11      | 0.750  | 59.250 | RND Ø0.390                 |
| 12      | 0.750  | 0.750  | RND Ø0.390                 |

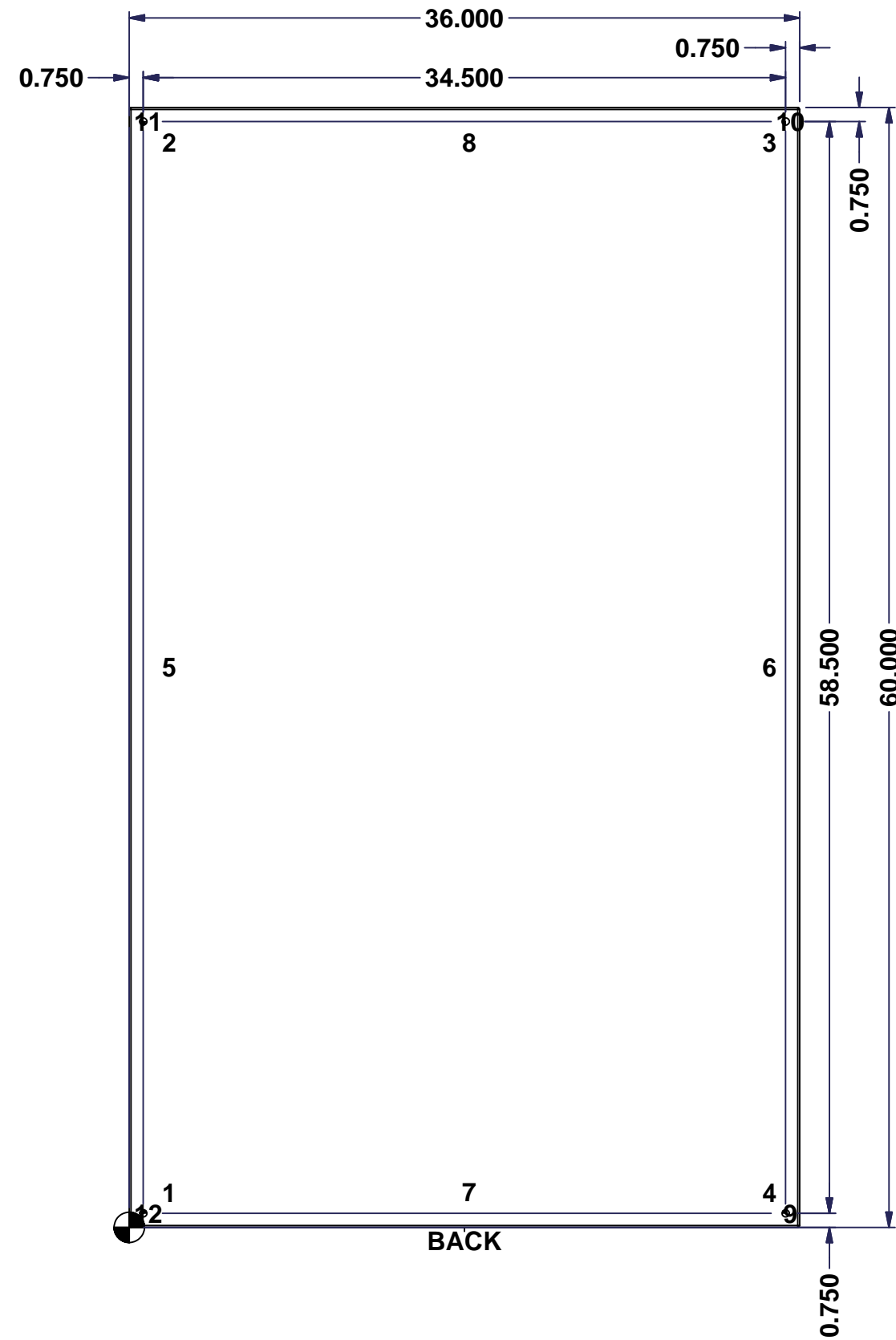

|  |                             |          |
|--|-----------------------------|----------|
|  | Description                 | Status   |
|  | 5412ESS 60" x 36" x 8" Body |          |
|  | Part Number                 | Rev.     |
|  | Numéro Pièce                | 6        |
|  | <b>5412ESS603608B</b>       | <b>0</b> |
|  |                             | 7        |

This drawing is confidential and must not be reproduced or used without the consent of EXM

Ce dessin est confidentiel et ne doit pas être reproduit ou utilisé sans le consentement de EXM

| No. | Revisions | Date | By/Par |
|-----|-----------|------|--------|
|     |           |      |        |
|     |           |      |        |
|     |           |      |        |
|     |           |      |        |
|     |           |      |        |

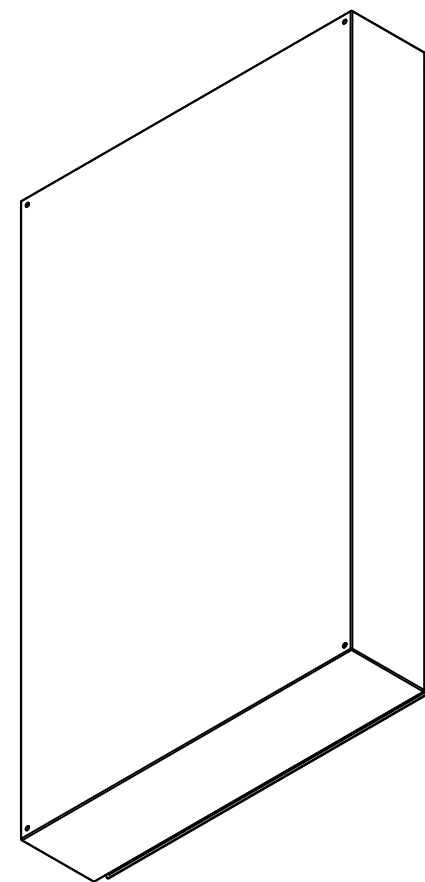

Isometric View

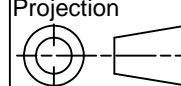

|  |   |
|--|---|
|  Tél: (450) 979-4373<br>Fax: (450) 979-4626<br><a href="http://www.exmweb.com">www.exmweb.com</a> | Flatness<br>Aplatissement<br>Max 3.0mm  |
|  | Projection<br> |
| Customer Client  | Date  |
| Drawn By<br>Dessiné Par BoxCad: BoxCad   | Date 08-Feb-14  |
| Material<br>Matière 14 Ga Stainless Steel 304 (1.7mm)  |   |
| Color<br>Couleur Unpainted   | Finish<br>Fini Brushed  |
| Description<br>5412ESS 60" x 36" x 8" Body   |   |
| Part Number<br>Numéro Pièce<br><b>5412ESS603608B</b>   | Detail Rev.<br>Rev. 7<br><b>0</b>   |

| Qty        | Part Number      | Rev | Description                           |
|------------|------------------|-----|---------------------------------------|
| 1          | STK-Q-16085      | 0   | Ground Stud M6 x 16mm Stainless Steel |
| 8          | STK-Q-16020      | 1   | Stud M8 x 35mm Stainless Steel        |
| 1          | 5412ESS603608B-P | 0   | 5412ESS 60" x 36" x 8" Body Part      |
| Parts List |                  |     |                                       |

This drawing is confidential and must not be reproduced or used without the consent of EXM

Ce dessin est confidentiel et ne doit pas être reproduit ou utilisé sans le consentement de EXM

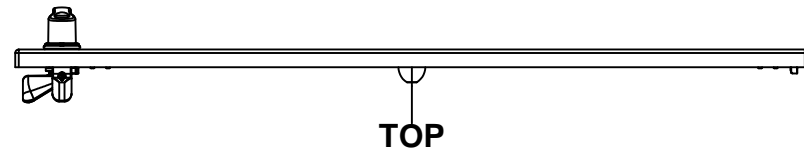

TOP

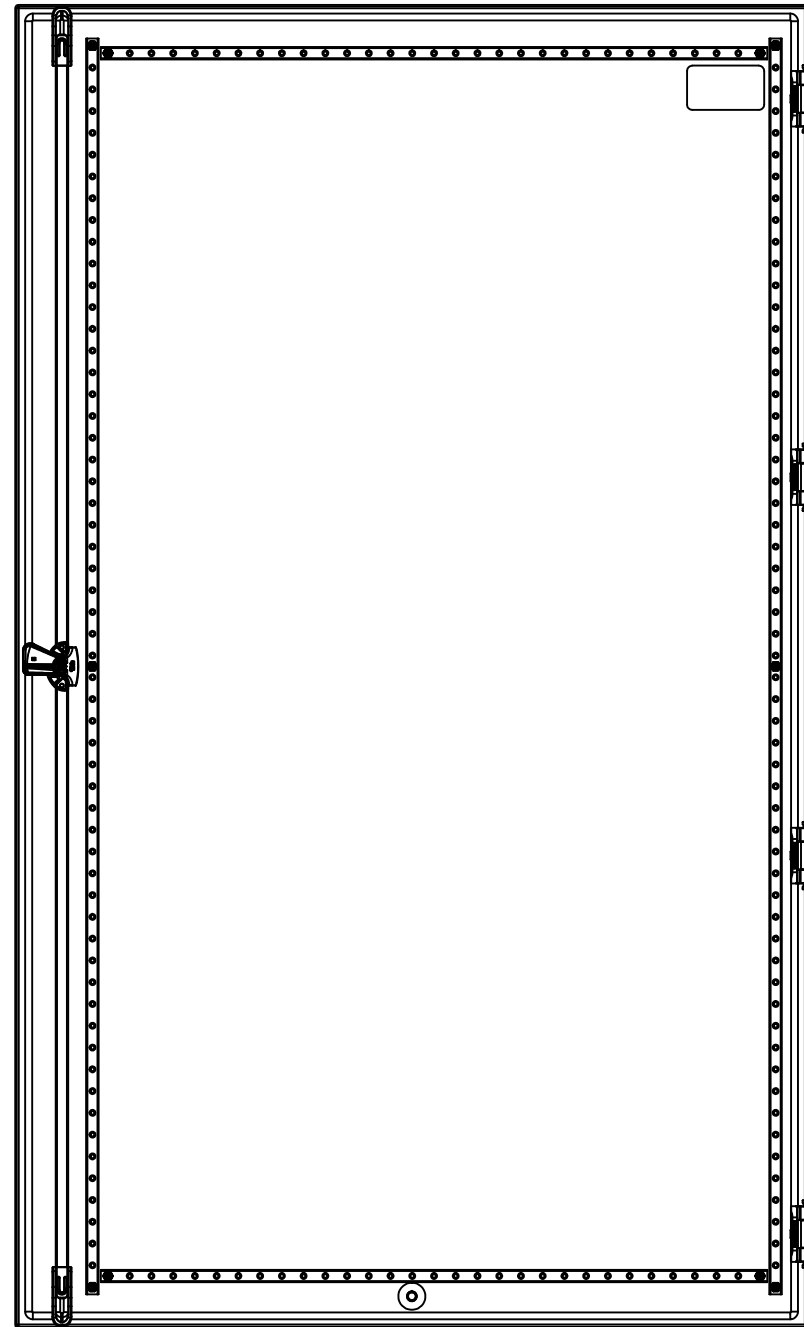

BACK

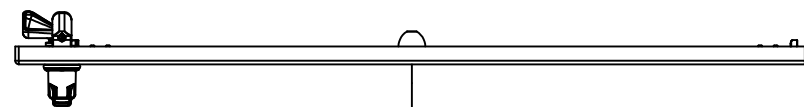

BOTTOM

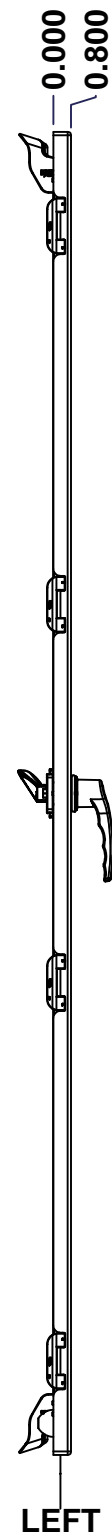

LEFT

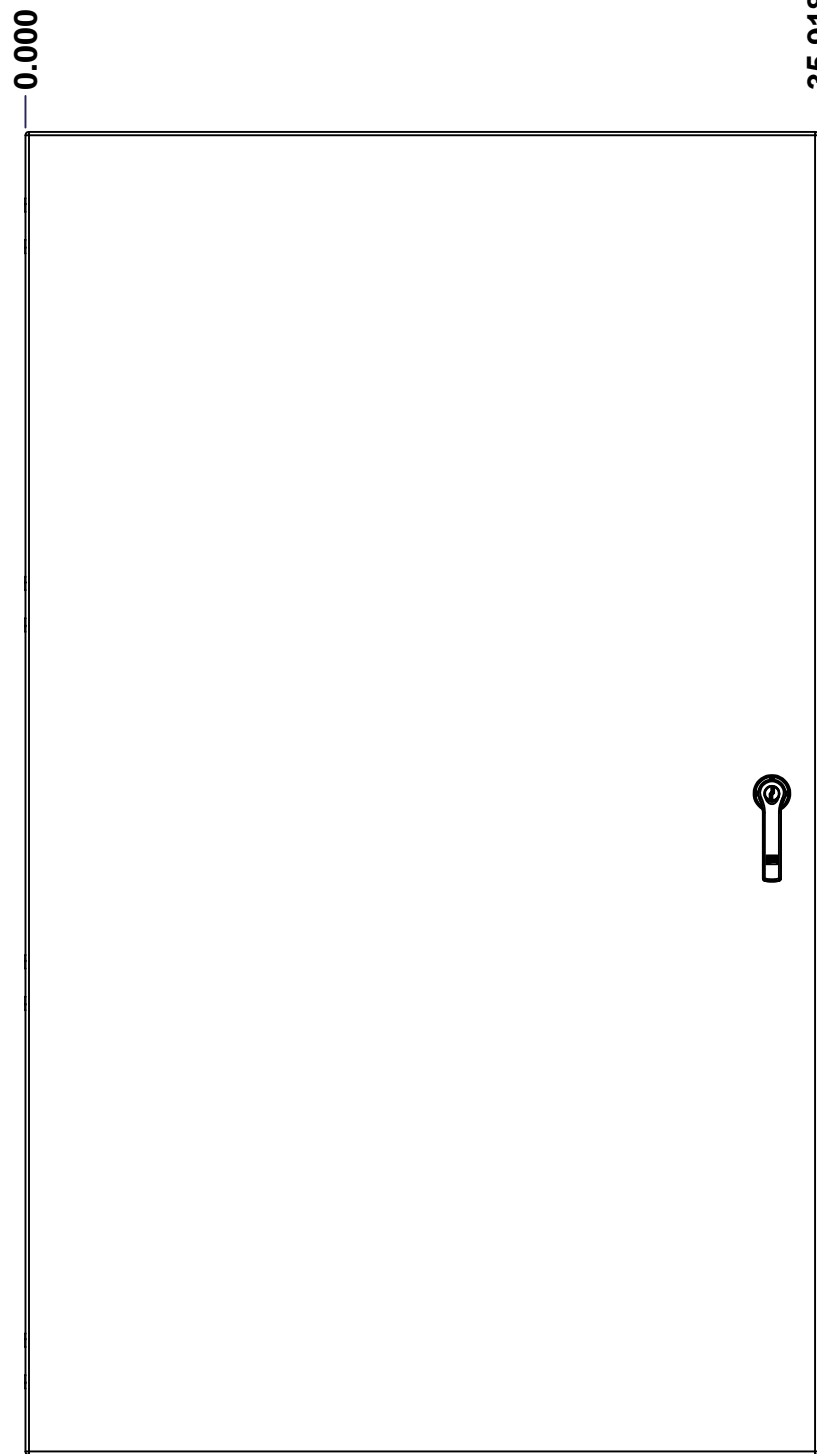

FRONT

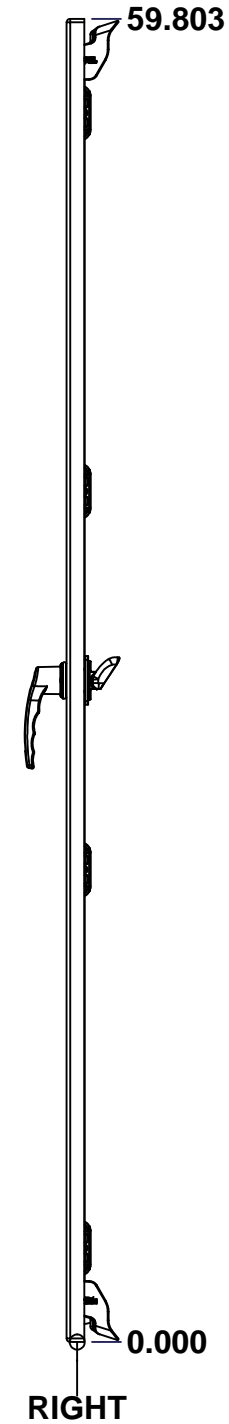

RIGHT

0.000  
0.800

0.000

35.918

59.803

0.000

| No. | Revisions | Date | By/Par |
|-----|-----------|------|--------|
|     |           |      |        |
|     |           |      |        |
|     |           |      |        |
|     |           |      |        |
|     |           |      |        |

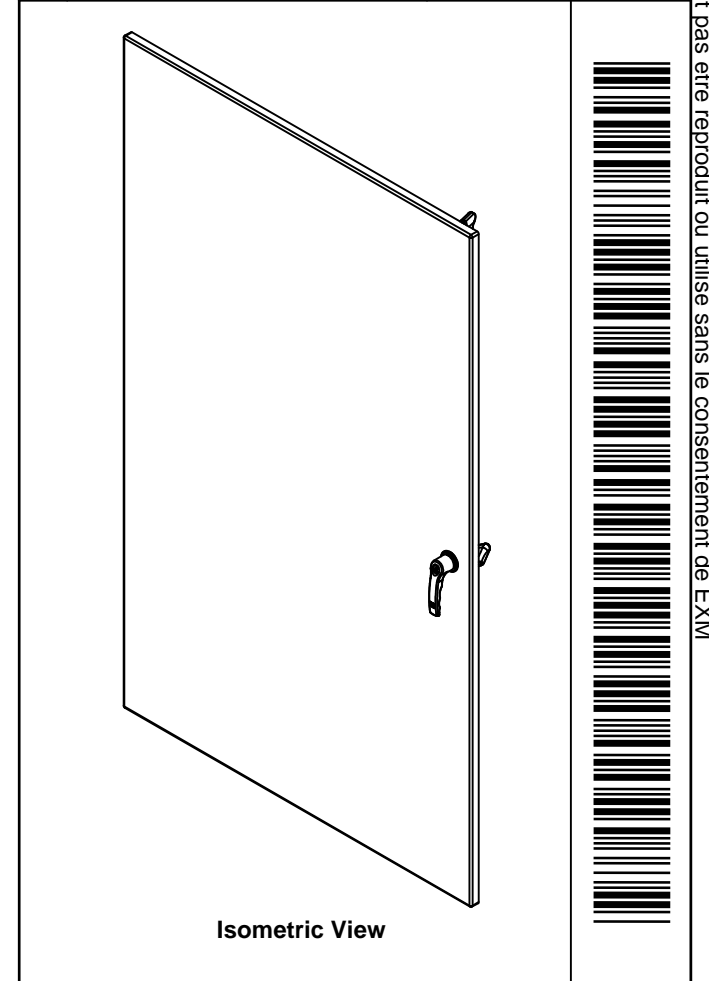

Isometric View

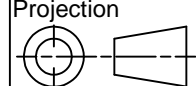
|  |                                   |   |
|--|-----------------------------------|---|
|  Tél: (450) 979-4373<br>Fax: (450) 979-4626<br><a href="http://www.exmweb.com">www.exmweb.com</a> |                                   | Flatness<br>Aplatissement<br>Max 3.0mm<br>Projection<br> |
| Customer Client  | Date                              |   |
| Drawn By<br>Dessiné Par  | BoxCad: BoxCad                    | Date 08-Feb-14  |
| Material<br>Matière  | 14 Ga Stainless Steel 304 (1.7mm) |   |
| Color<br>Couleur   | Unpainted                         | Finish<br>Fini Brushed  |
| Description  | Detail Rev.                       |   |
| 5412ESS 60" x 36" Cover  |                                   |   |
| Part Number<br>Numéro Pièce  | Rev.                              | 1<br>3  |
| 5412ESS603608C   | 0                                 |   |

SEE BILL OF MATERIAL ON LAST PAGE

This drawing is confidential and must not be reproduced or used without the consent of EXM

Ce dessin est confidentiel et ne doit pas être reproduit ou utilisé sans le consentement de EXM

**STANDARD FEATURES ARE NOT LISTED IN THIS HOLE TABLE**

**HOLE TABLE - FRONT VIEW (CUSTOM FEATURE ONLY)**

| CUT-OUT | XDIM   | YDIM   | DESCRIPTION                 |
|---------|--------|--------|-----------------------------|
| 1       | 1.486  | 1.850  | STUD M6 x 18mm (Inside)     |
| 2       | 1.486  | 57.953 | STUD M6 x 18mm (Inside)     |
| 3       | 32.423 | 57.953 | STUD M6 x 18mm (Inside)     |
| 4       | 32.423 | 1.850  | STUD M6 x 18mm (Inside)     |
| 5       | 1.486  | 29.902 | STUD M6 x 18mm (Inside)     |
| 6       | 32.423 | 29.902 | STUD M6 x 18mm (Inside)     |
| 7       | 2.191  | 2.350  | STUD M6 x 18mm (Inside)     |
| 8       | 2.191  | 57.619 | STUD M6 x 18mm (Inside)     |
| 9       | 31.718 | 57.619 | STUD M6 x 18mm (Inside)     |
| 10      | 31.718 | 2.350  | STUD M6 x 18mm (Inside)     |
| 11      | 33.803 | 54.896 | CLOSING BAR STUD (Inside)   |
| 12      | 33.803 | 4.907  | CLOSING BAR STUD (Inside)   |
| 13      | 17.959 | 1.435  | STUD M6 x 18mm (Inside)     |
| -----   |        |        |                             |
| 14      | 3.750  | 56.053 | LABEL_EXM (Inside)          |
| 15      | 33.803 | 29.902 | HANDLE 885 ESL2A-LSS @ 0.0° |

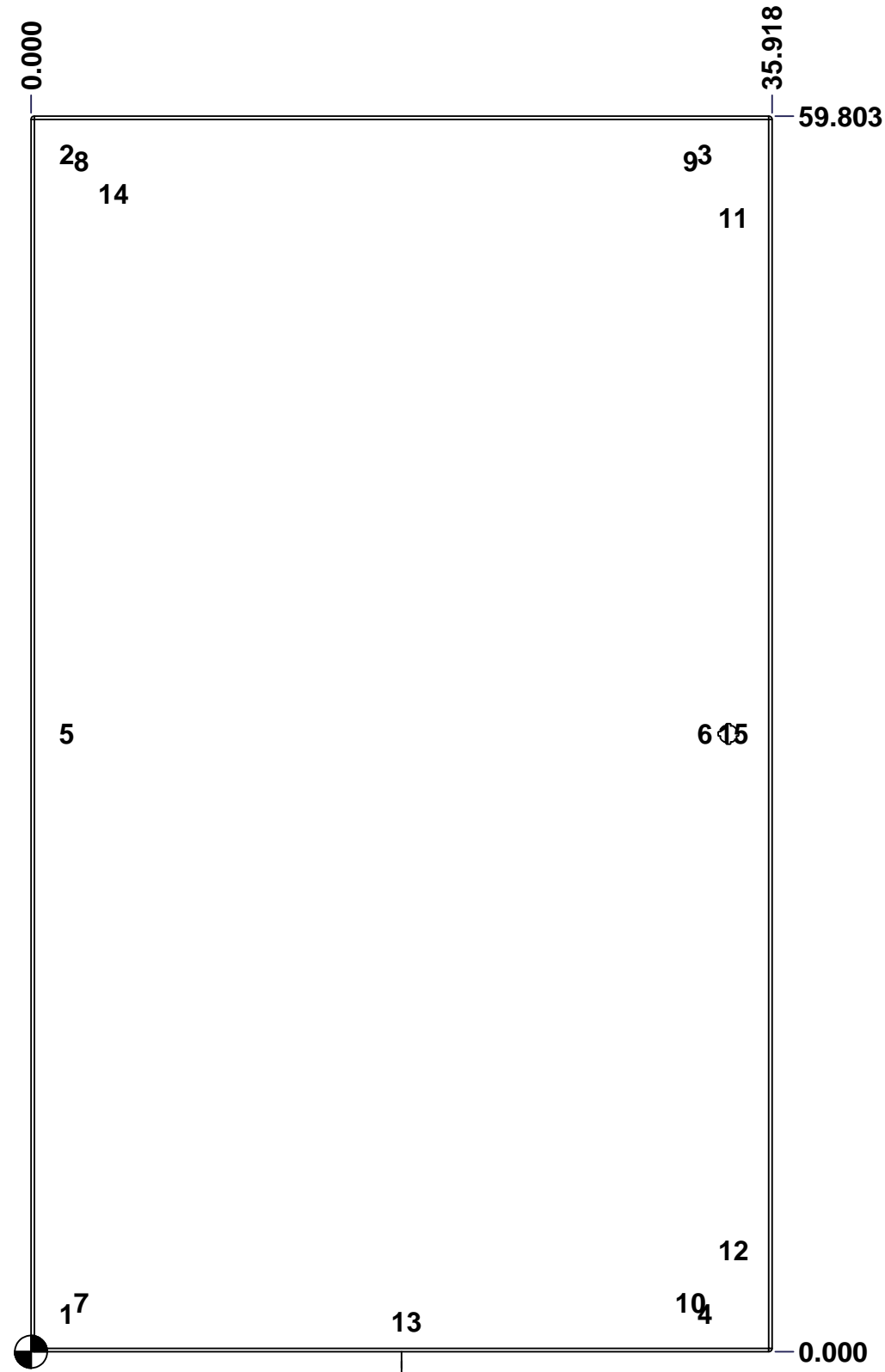

|  |                             |        |
|--|-----------------------------|--------|
|  | Description                 | Status |
|  | 5412ESS 60" x 36" Cover     | (NULL) |
|  | Part Number<br>Numéro Pièce | Rev.   |
|  | 5412ESS603608C              | 0      |
|  |                             | 2      |
|  |                             | 3      |



This drawing is confidential and must not be reproduced or used without the consent of EXM

Ce dessin est confidentiel et ne doit pas être reproduit ou utilisé sans le consentement de EXM

| No. | Revisions | Date | By/Par |
|-----|-----------|------|--------|
|     |           |      |        |
|     |           |      |        |
|     |           |      |        |
|     |           |      |        |
|     |           |      |        |

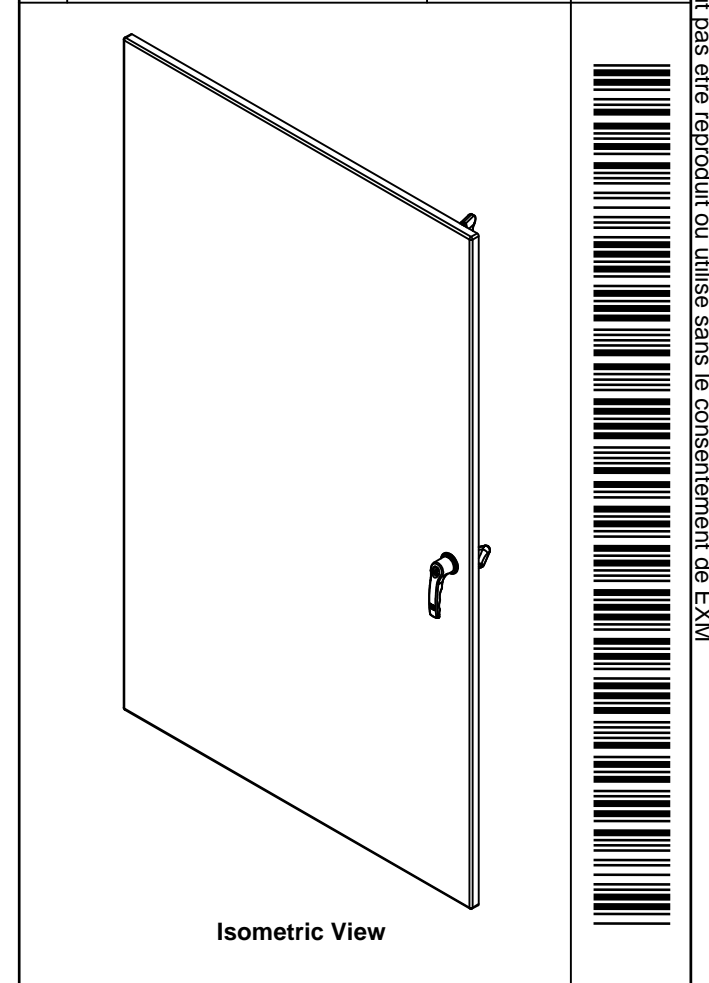

| 2          | STK-Q-90042      | 4   | 5412 ES - Cabinet Closing Bar End (Small)     |
|------------|------------------|-----|---|
| 2          | STK-Q-45655-60   | 0   | 5412 ES - Closing Bar                         |
| 1          | STK-Q-50536      | 11  | 5412 ES - Handle Cam Clockwise (Grip 32mm)    |
| 1          | 885 ESL2A-LSS    | 3   | 5412 ESS Key Lock L-Handle (3 Pts)            |
| 1          | STK-S-00100      | 0   | 3.5" x 2" Silver Milar Flexcon Sticker        |
| 1          | STK-Q-46515      | 3   | 5412 ES Door Support with Brass Insert        |
| 2          | STK-Q-46025-36-3 | 0.1 | 5412 ES Horizontal Door Stiffener 36" (3 Pts) |
|            |                  | 1   |   |
| 2          | STK-Q-46020-60   | 5   | 5412 ES Vertical Door Stiffener 60"           |
| 2          | STK-Q-16407      | 2   | Guide Stud - Small (No Paint Cap Required)    |
| 11         | STK-Q-16070      | 1   | Stud M6 x 18mm Stainless steel                |
| 1          | 5412ESS603608G   | 0   | 5412ESS 60" x 36" Cover Gasket Part           |
| 1          | 5412ESS603608C-P | 0   | 5412ESS 60" x 36" Cover Part                  |
| 4          | STK-K-09850      | 6   | 5412 ESS Hinge with 2 Captive Hinge Pins      |
| 10         | STK-Q-07220      | 1   | M6 Nylon Insert Lock Nut                      |
| Qty        | Part Name        | Rev | Description                                   |
| Parts List |                  |     |   |

|  |  |                                   |             |
|--|--|-----------------------------------|-------------|
|  Tél: (450) 979-4373<br>Fax: (450) 979-4626<br><a href="http://www.exmweb.com">www.exmweb.com</a> |  | Flatness<br>Aplatissement         |             |
|  |  | Max 3.0mm                         |             |
| Customer<br>Client   |  | Date                              |             |
| Drawn By<br>Dessiné Par  |  | Date 08-Feb-14                    |             |
| Material<br>Matière  |  | 14 Ga Stainless Steel 304 (1.7mm) |             |
| Color<br>Couleur   |  | Finish<br>Fini                    |             |
| Unpainted  |  | Brushed                           |             |
| Description  |  |                                   | Detail Rev. |
| 5412ESS 60" x 36" Cover  |  |                                   |             |
| Part Number<br>Numéro Pièce  |  | Rev.                              | 3           |
| <b>5412ESS603608C</b>  |  | <b>0</b>                          | <b>3</b>    |

This drawing is confidential and must not be reproduced or used without the consent of EXM

Tolerance ±1/32" unless otherwise specified

C:\Vault Workspace\Inventor Dwg\Inv-8\881SP\881SP6036G.idw

Tolérance ±1/32" sauf spécification contraire

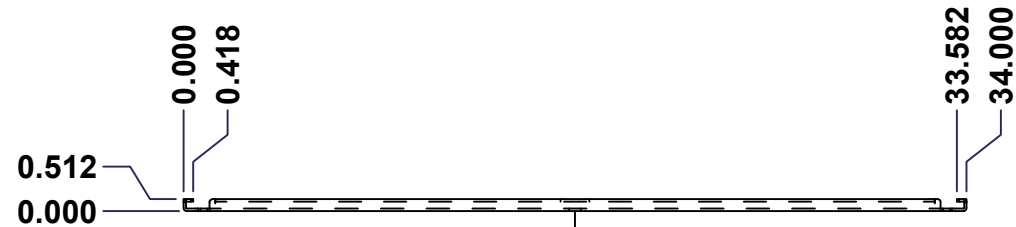

TOP

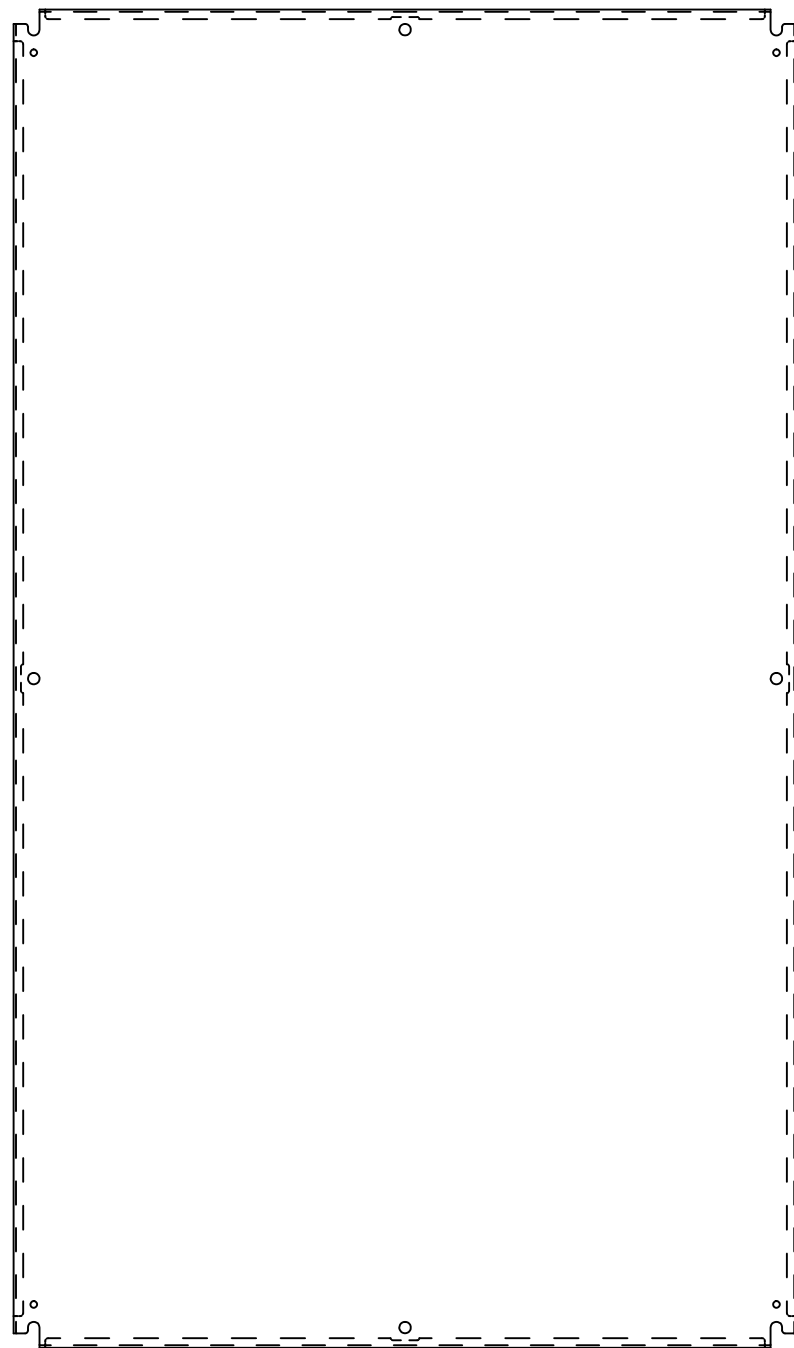

FRONT

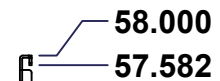

RIGHT

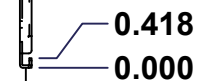

| No. | Revisions | Date | By/Par |
|-----|-----------|------|--------|
|     |           |      |        |
|     |           |      |        |
|     |           |      |        |
|     |           |      |        |
|     |           |      |        |

Isometric View

Ce dessin est confidentiel et ne doit pas être reproduit ou utilisé sans le consentement de EXM

|   |  |  |  |  |  |
|---|--|--|--|--|--|
|   |  | Tél: (450) 979-4373<br>Fax: (450) 979-4626<br>www.exmweb.com |  | Flatness<br>Aplatissement<br>Max 3.0mm |  |
| Customer<br>Client                              |  | Date   |  | Projection<br>                         |  |
| Drawn By<br>Dessiné Par: BoxCad                 |  | Date: 1/23/2007  |  | Material<br>Matière: See Part List     |  |
| Color<br>Couleur: See Part List                 |  | Finish<br>Fini: See Part List                                |  | Description<br>881 SP - Inner Panel    |  |
| Part Number<br>Numéro Pièce: <b>881 SP6036G</b> |  | Detail Rev.  |  | Rev. 1<br>0                            |  |

| Qty | Part Number   | Rev | Description               | Material         | Color     | Finish     |
|-----|---------------|-----|---------------------------|------------------|-----------|------------|
| 1   | 881 SP6036G-P | 0   | 881 SP - Inner Panel Part | 12 Ga Galvanized | Unpainted | Galvanized |

Parts List

This drawing is confidential and must not be reproduced or used without the consent of EXM

Ce dessin est confidentiel et ne doit pas être reproduit ou utilisé sans le consentement de EXM

| Table 1 |        |        | FRONT VIEW                 |
|---------|--------|--------|----------------------------|
| CUT-OUT | XDIM   | YDIM   | DESCRIPTION                |
| 1       | 17.000 | 0.875  | MTG STUD HOLE (RND Ø0.500) |
| 2       | 0.875  | 29.000 | MTG STUD HOLE (RND Ø0.500) |
| 3       | 33.125 | 29.000 | MTG STUD HOLE (RND Ø0.500) |
| 4       | 17.000 | 57.125 | MTG STUD HOLE (RND Ø0.500) |
| 5       | 0.875  | 1.875  | GROUND HOLE (RND Ø0.290)   |
| 6       | 33.125 | 1.875  | GROUND HOLE (RND Ø0.290)   |
| 7       | 0.875  | 56.125 | GROUND HOLE (RND Ø0.290)   |
| 8       | 33.125 | 56.125 | GROUND HOLE (RND Ø0.290)   |

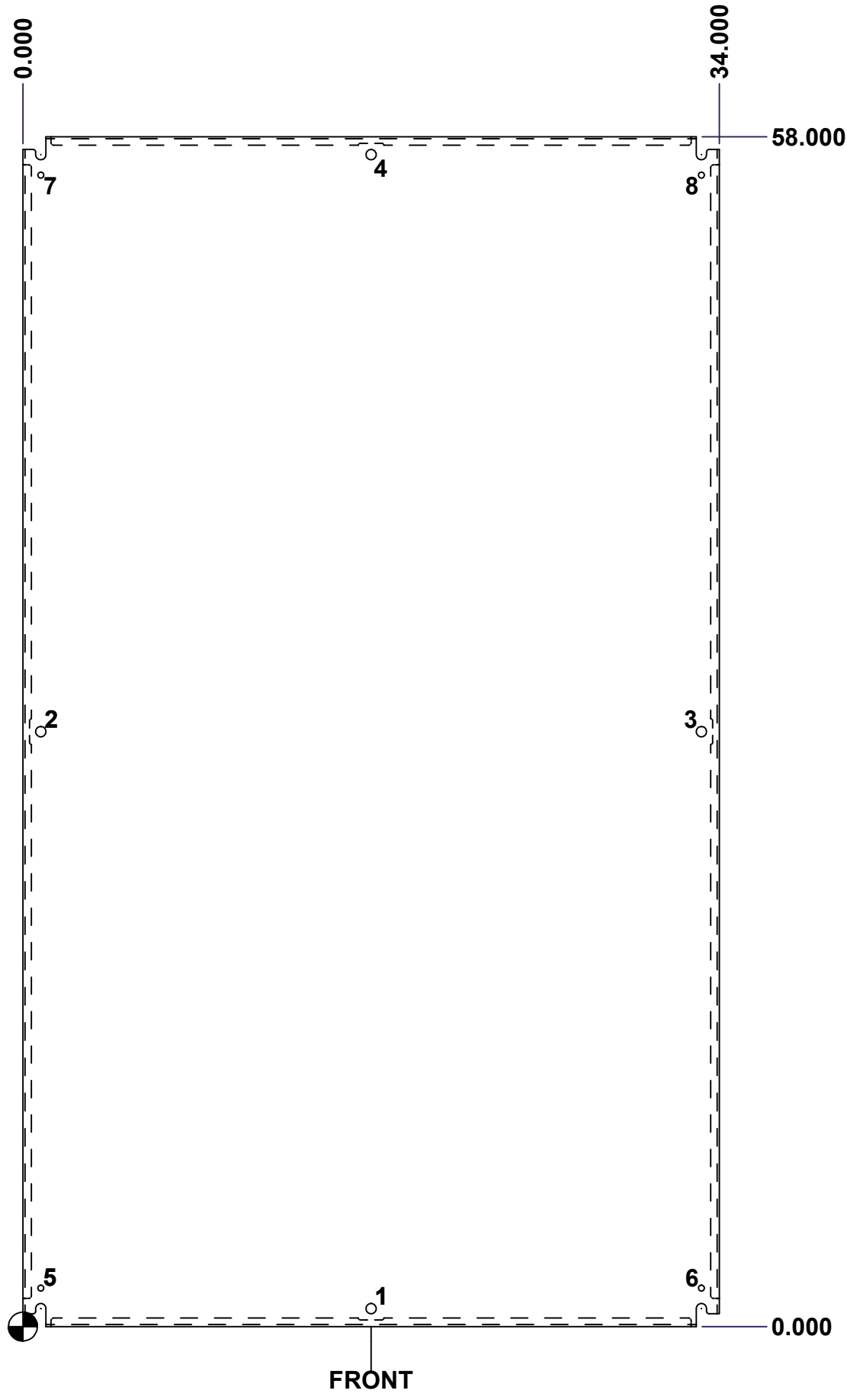

All knockouts are actual size / Les disques défonçables sont grandeur réel

| No. | Revisions | Date | By/Par |
|-----|-----------|------|--------|
|     |           |      |        |
|     |           |      |        |
|     |           |      |        |
|     |           |      |        |
|     |           |      |        |
|     |           |      |        |

Isometric View

|   |  |  |  |  |  |
|---|--|--|--|--|--|
|   |  | Tél: (450) 979-4373<br>Fax: (450) 979-4626<br>www.exmweb.com |  | Flatness<br>Aplatissement<br>Max 3.0mm |  |
| Customer<br>Client                                |  | Date   |  | Projection<br>                         |  |
| Drawn By<br>Dessiné Par                           |  | BoxCad   |  | Date 1/23/2007                         |  |
| Material<br>Matière                               |  | See Part List  |  |  |  |
| Color<br>Couleur                                  |  | See Part List  |  | Finish<br>Fini See Part List           |  |
| Description<br>881 SP - Inner Panel               |  |  |  | Detail Rev.                            |  |
| Part Number<br>Numéro Pièce<br><b>881 SP6036G</b> |  |  |  | Rev. 2<br><b>0</b>                     |  |