

This drawing is confidential and must not be reproduced or used without the consent of EXM

Ce dessin est confidentiel et ne doit pas être reproduit ou utilisé sans le consentement de EXM

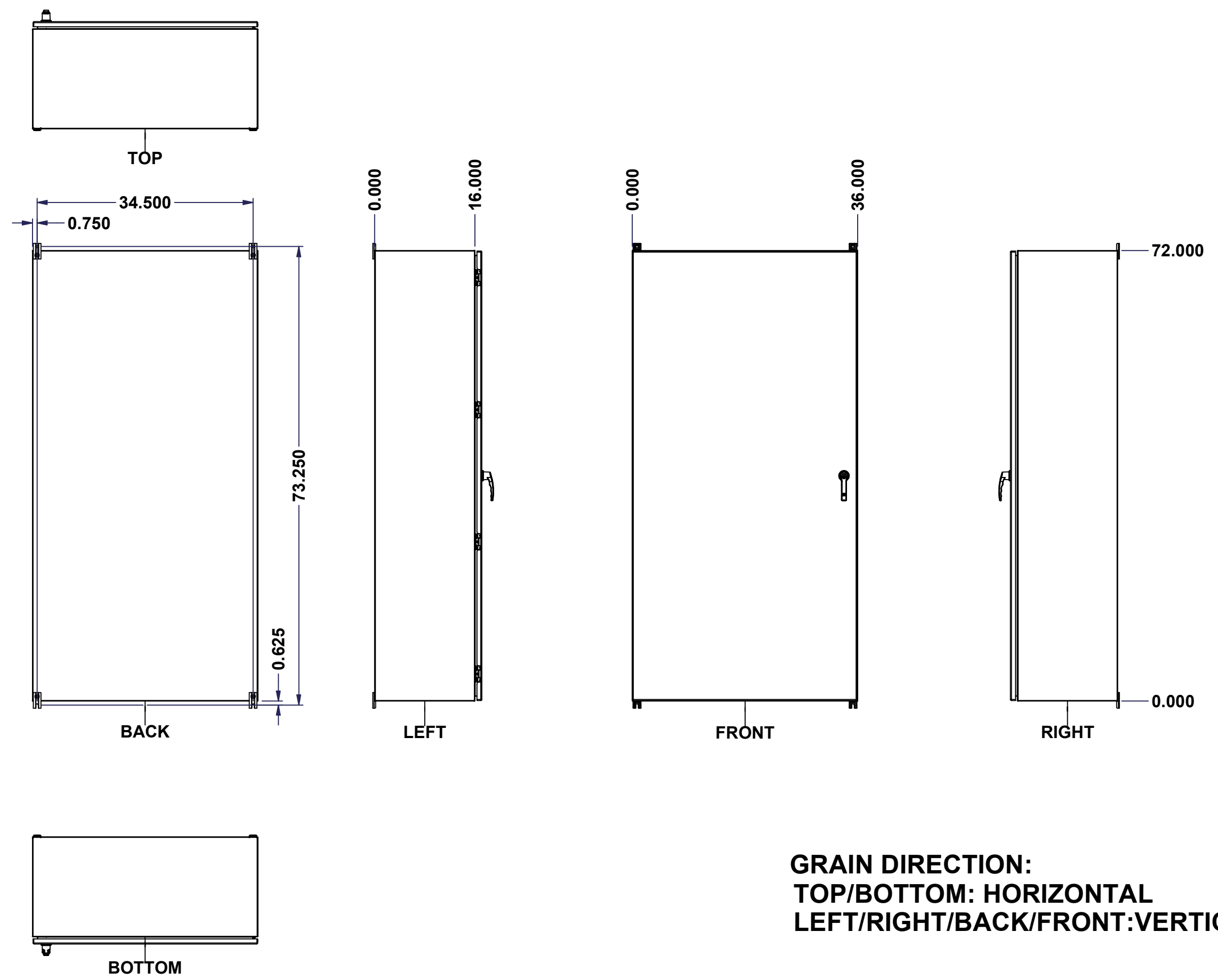

**GRAIN DIRECTION:  
TOP/BOTTOM: HORIZONTAL  
LEFT/RIGHT/BACK/FRONT: VERTICAL**

| No. | Revisions | Date | By/Par |
|-----|-----------|------|--------|
|     |           |      |        |
|     |           |      |        |
|     |           |      |        |
|     |           |      |        |

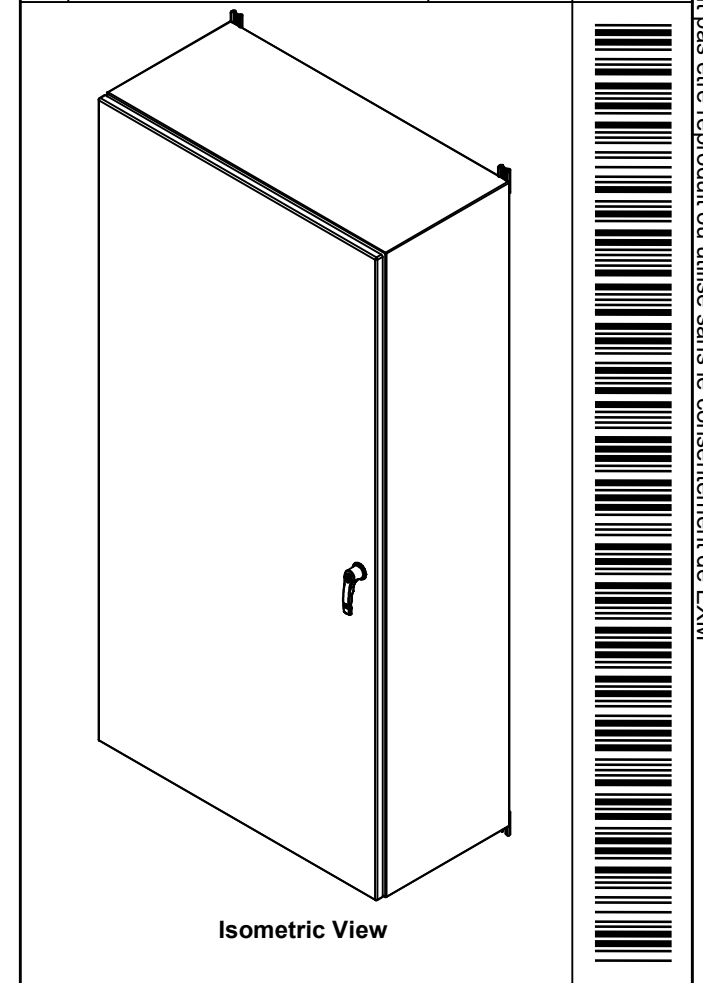

|  |  |                           |        |
|--|--|---------------------------|--------|
| Tél: (450) 979-4373<br>Fax: (450) 979-4626<br><a href="http://www.exmweb.com">www.exmweb.com</a> |  | Flatness<br>Aplatissement |        |
|  |  | Max 3.0mm                 |        |
| Customer<br>Client   |  | Date                      |        |
| Drawn By<br>Dessiné Par: BoxCad: BoxCad  |  | Date: 17-May-23           |        |
| Material<br>Matière: 14 Ga Stainless Steel 316 (1.7mm)   |  | Projection                |        |
| Color<br>Couleur: Unpainted  |  | Finish<br>Fini: Brushed   |        |
| Description<br>5412ESS 72" x 36" x 16" Assembly  |  | Detail Rev.               |        |
| Part Number<br>Numéro Pièce: <b>5412ESS7236166TH</b>   |  | Rev. <b>0</b>             | 1 / 16 |

SEE BILL OF MATERIAL ON LAST PAGE

This drawing is confidential and must not be reproduced or used without the consent of EXM

Ce dessin est confidentiel et ne doit pas être reproduit ou utilisé sans le consentement de EXM

| NOTE |   |
|------|---|
| ITEM | DESCRIPTION                                     |
| 1    | NEMA 4X Enclosure                               |
| 2    | C/W Standard ground studs on box and cover      |
| 3    | C/W Standard door stiffener                     |
| 4    | C/W Standard inner panel (Included)             |
| 5    | C/W Standard inner panel mounting studs         |
| 6    | C/W 885 ESMF4_OPEN Sold separately (Installed)  |
| 7    | C/W 885 ESMF4_CLOSE Sold separately (Installed) |
| 8    | C/W R5 Insulation (Installed by EXM)            |

| No. | Revisions | Date | By/Par |
|-----|-----------|------|--------|
|     |           |      |        |
|     |           |      |        |
|     |           |      |        |
|     |           |      |        |
|     |           |      |        |

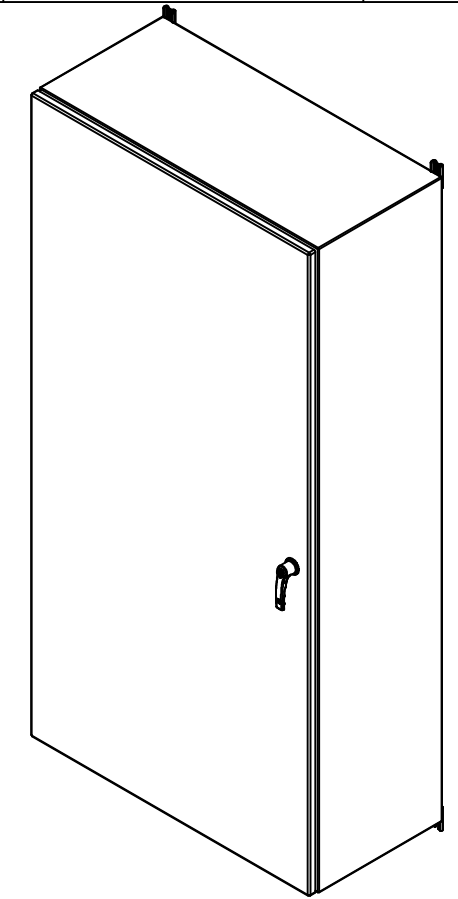

Isometric View



| PACKING               |     |  |
|-----------------------|-----|--|
| ITEM                  | QTY | DESCRIPTION                                    |
| Cardboard sleeve      | 2   | Top and Bottom                                 |
| Cardboard strip       | 2   | Between back of enclosure and inner panel      |
| Plastic bag           | 1   | To protect cover surface and inside gasket     |
| Cardboard corner      | 4   | To reinforced for the plastic strap tightening |
| Plastic strap - Black | 2   | To Squeeze the 2 cardboard sleeve together     |
| Packaging label       | 3   | White label with PN                            |
| Plastic strap- Green  | 2   | To secure the enclosure to the wood pallet     |
| Wood Pallet           | 1   | 2" deeper and 3" larger than enclosure size    |

|            |                   |     |  |
|------------|-------------------|-----|--|
| 8          | STK-Q-00600       | 2   | M12 to M8 Adaptor  |
| 1          | 881 SP7236G       | 0   | 881 SP - Inner Panel   |
| 1          | STK-K-01800       | 5   | 5412 ES Accessory Kit  |
| 1          | 5412ESS7236166THC | 0   | 5412ESS 72" x 36" Cover  |
| 1          | 5412ESS7236166THB | 0   | 5412ESS 72" x 36" x 16" Body   |
| 4          | STK-Q-04051-08    | 1   | M6 x 8mm Stainless Steel Hexagon Socket Head Machine Screw with Nyseal |
| Qty        | Part Number       | Rev | Description  |
| Parts List |                   |     |  |

|   |                                   |                        |
|---|-----------------------------------|------------------------|
| <p>Tél: (450) 979-4373<br/>Fax: (450) 979-4626<br/><a href="http://www.exmweb.com">www.exmweb.com</a></p> | Flatness<br>Aplatissement         | Max 3.0mm              |
|   | Projection                        |                        |
| Customer Client   | Date                              |                        |
| Drawn By<br>Dessiné Par   | BoxCad: BoxCad                    | Date 17-May-23         |
| Material<br>Matière   | 14 Ga Stainless Steel 316 (1.7mm) |                        |
| Color<br>Couleur  | Unpainted                         | Finish<br>Fini Brushed |
| Description   | Detail Rev.                       |                        |
| 5412ESS 72" x 36" x 16" Assembly  |                                   |                        |
| Part Number<br>Numéro Pièce   | Rev.                              | 2                      |
| <b>5412ESS7236166TH</b>   | <b>0</b>                          | 16                     |

This drawing is confidential and must not be reproduced or used without the consent of EXM

Ce dessin est confidentiel et ne doit pas être reproduit ou utilisé sans le consentement de EXM

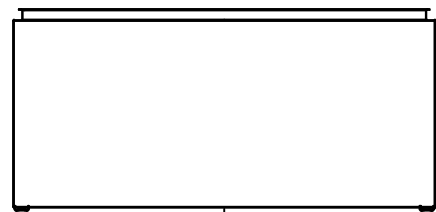

TOP

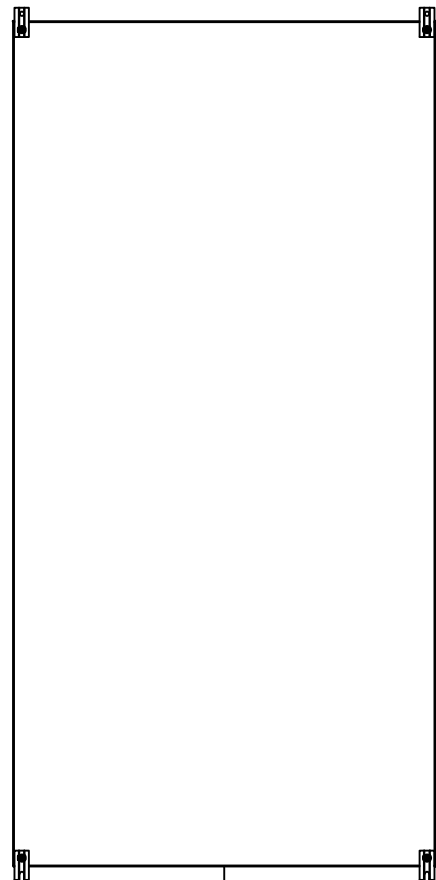

BACK

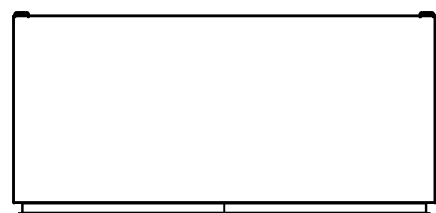

BOTTOM

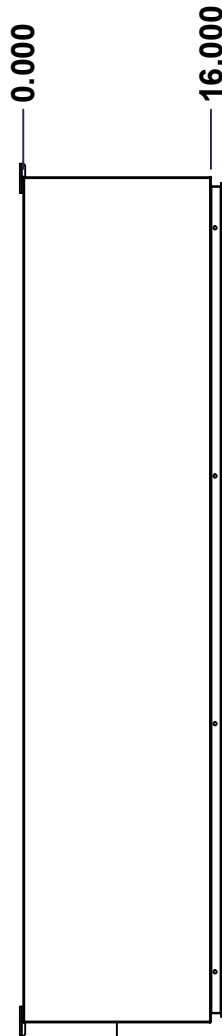

LEFT

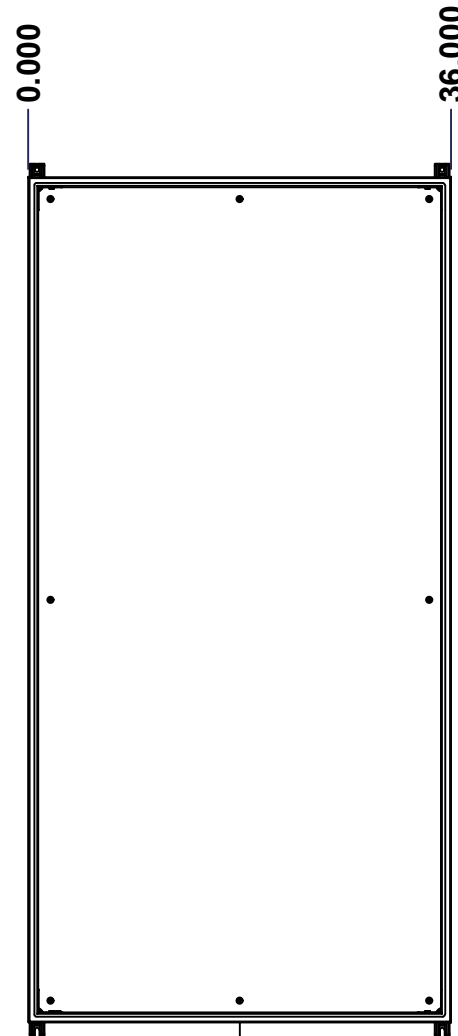

FRONT

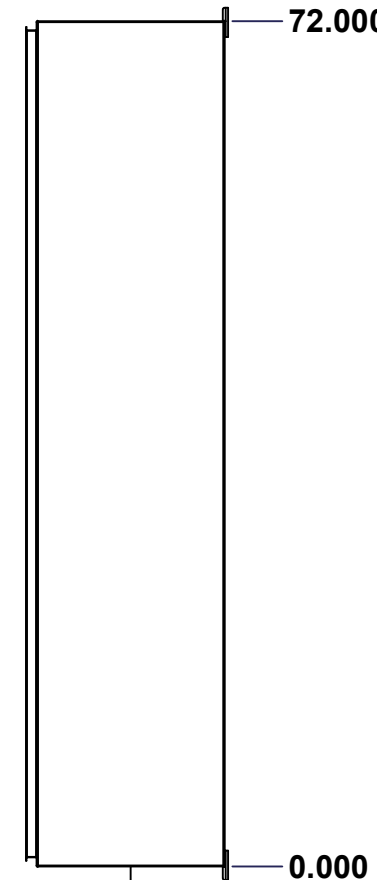

RIGHT

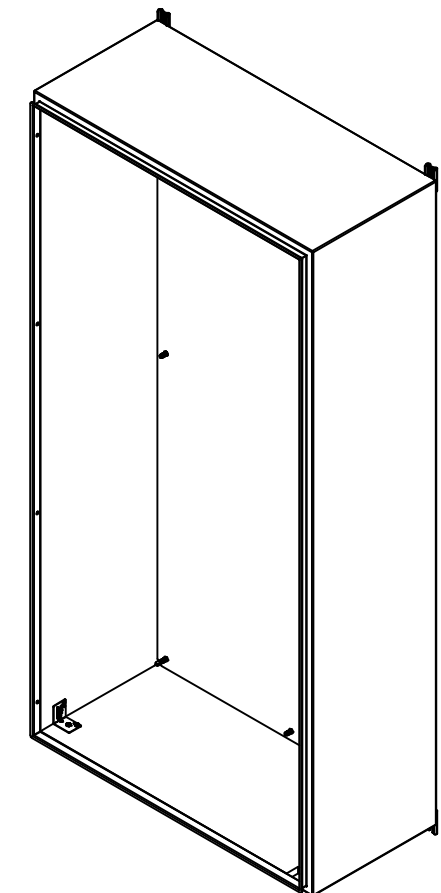

Isometric View

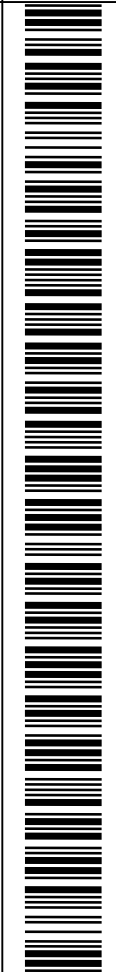

| No. | Revisions | Date | By/Par |
|-----|-----------|------|--------|
|     |           |      |        |
|     |           |      |        |
|     |           |      |        |
|     |           |      |        |

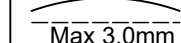
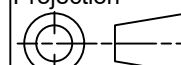
|  |                                   |  |
|--|-----------------------------------|--|
|  Tél: (450) 979-4373<br>Fax: (450) 979-4626<br><a href="http://www.exmweb.com">www.exmweb.com</a> |                                   | Flatness<br>Aplatissement<br><br>Max 3.0mm<br>Projection<br> |
| Customer Client  | Date                              |  |
| Drawn By<br>Dessiné Par  | BoxCad: BoxCad                    | Date 17-May-23   |
| Material<br>Matière  | 14 Ga Stainless Steel 316 (1.7mm) |  |
| Color<br>Couleur   | Unpainted                         | Finish<br>Fini Brushed   |
| Description  | Detail Rev.                       |  |
| 5412ESS 72" x 36" x 16" Body   |                                   |  |
| Part Number<br>Numéro Pièce  | Rev.                              | 3  |
| 5412ESS7236166THB  | 0                                 | 16   |

SEE BILL OF MATERIAL ON LAST PAGE

This drawing is confidential and must not be reproduced or used without the consent of EXM

Ce dessin est confidentiel et ne doit pas être reproduit ou utilisé sans le consentement de EXM

| <b>STANDARD FEATURES ARE NOT LISTED IN THIS HOLE TABLE</b> |        |        |                                |
|--|--------|--------|--------------------------------|
| <b>HOLE TABLE - TOP VIEW (CUSTOM FEATURE ONLY)</b>         |        |        |                                |
| CUT-OUT  | XDIM   | YDIM   | DESCRIPTION                    |
| 1  | 2.000  | 13.500 | INSUL. STUD M6 x 18mm (Inside) |
| 2  | 34.000 | 13.500 | INSUL. STUD M6 x 18mm (Inside) |

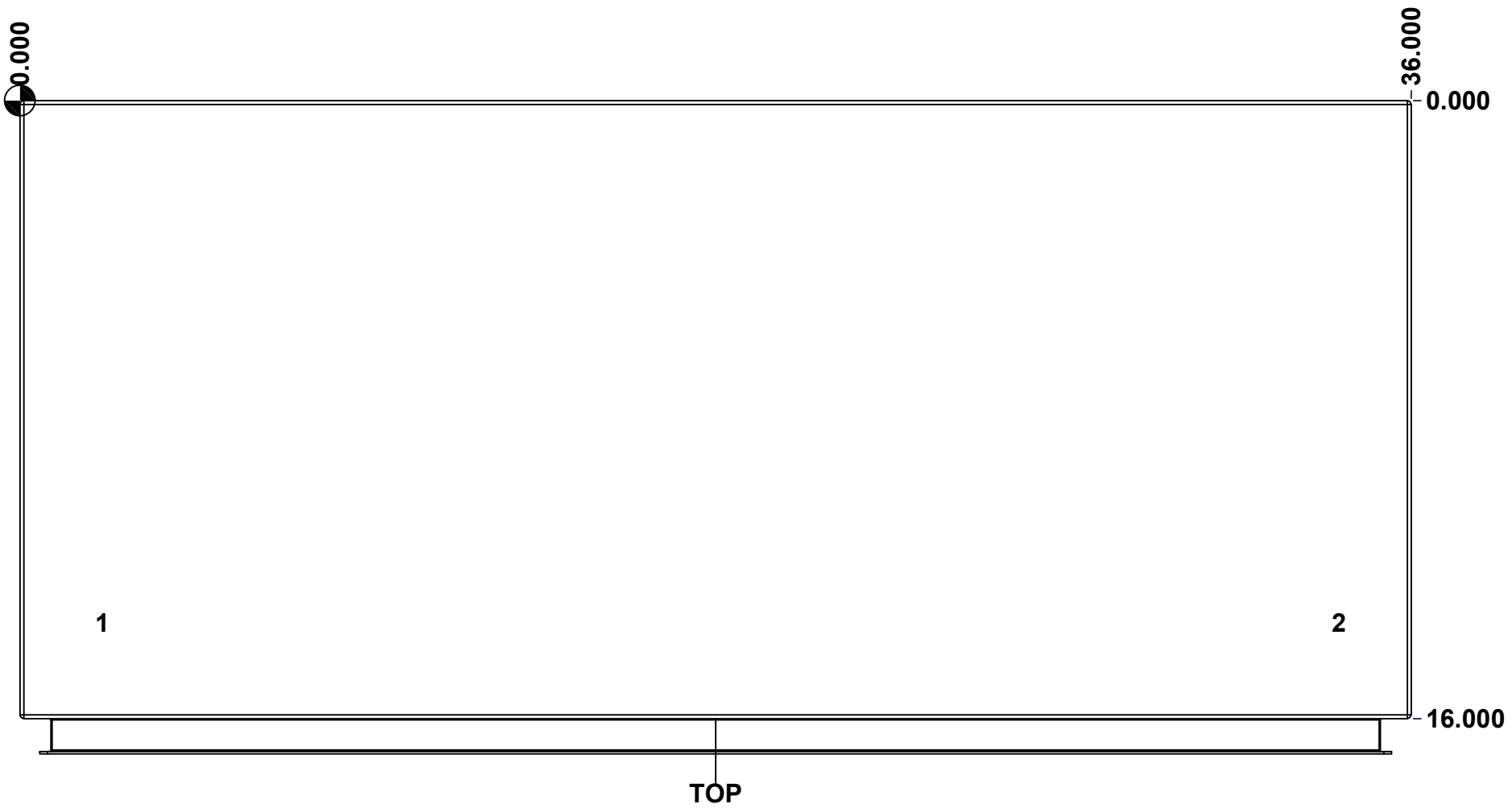

|  |                              |          |        |
|--|------------------------------|----------|--------|
|  | Description                  | Status   |        |
|  | 5412ESS 72" x 36" x 16" Body | (NULL)   |        |
|  | Part Number<br>Numéro Pièce  | Rev.     |        |
|  | <b>5412ESS7236166THB</b>     | <b>0</b> | 4 / 16 |

This drawing is confidential and must not be reproduced or used without the consent of EXM

Ce dessin est confidentiel et ne doit pas être reproduit ou utilisé sans le consentement de EXM

| <b>STANDARD FEATURES ARE NOT LISTED IN THIS HOLE TABLE</b> |        |        |                                |
|--|--------|--------|--------------------------------|
| <b>HOLE TABLE - BOTTOM VIEW (CUSTOM FEATURE ONLY)</b>      |        |        |                                |
| CUT-OUT  | XDIM   | YDIM   | DESCRIPTION                    |
| 1  | 2.000  | 13.500 | INSUL. STUD M6 x 18mm (Inside) |
| 2  | 34.000 | 13.500 | INSUL. STUD M6 x 18mm (Inside) |

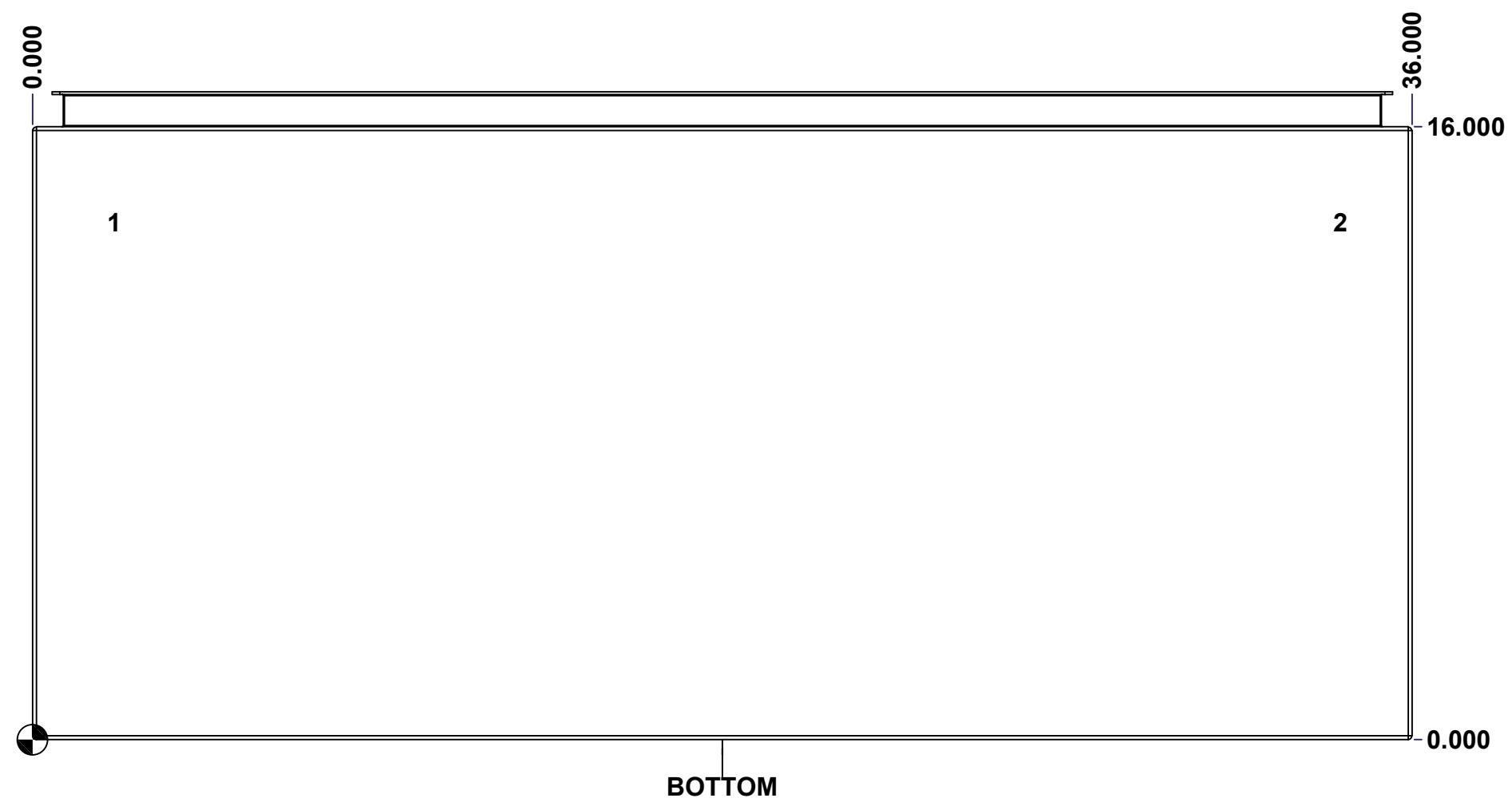

|  |                              |          |    |
|--|------------------------------|----------|----|
|  | Description                  | Status   |    |
|  | 5412ESS 72" x 36" x 16" Body | (NULL)   |    |
|  | Part Number<br>Numéro Pièce  | Rev.     | 5  |
|  | <b>5412ESS7236166THB</b>     | <b>0</b> | 16 |

This drawing is confidential and must not be reproduced or used without the consent of EXM

Ce dessin est confidentiel et ne doit pas être reproduit ou utilisé sans le consentement de EXM

**STANDARD FEATURES ARE NOT LISTED IN THIS HOLE TABLE**

**HOLE TABLE - BACK VIEW (CUSTOM FEATURE ONLY)**

| CUT-OUT | XDIM   | YDIM   | DESCRIPTION                |
|---------|--------|--------|----------------------------|
| 1       | 1.875  | 1.875  | IP STUD M8 x 35mm (Inside) |
| 2       | 1.875  | 70.125 | IP STUD M8 x 35mm (Inside) |
| 3       | 34.125 | 70.125 | IP STUD M8 x 35mm (Inside) |
| 4       | 34.125 | 1.875  | IP STUD M8 x 35mm (Inside) |
| 5       | 1.875  | 36.000 | IP STUD M8 x 35mm (Inside) |
| 6       | 34.125 | 36.000 | IP STUD M8 x 35mm (Inside) |
| 7       | 18.000 | 1.875  | IP STUD M8 x 35mm (Inside) |
| 8       | 18.000 | 70.125 | IP STUD M8 x 35mm (Inside) |
| -----   |        |        |                            |
| 9       | 35.250 | 0.000  | FOOT 885 ESMF4_OPEN        |
| 10      | 0.750  | 0.000  | FOOT 885 ESMF4_OPEN        |
| 11      | 35.250 | 72.000 | FOOT 885 ESMF4_CLOSE       |
| 12      | 0.750  | 72.000 | FOOT 885 ESMF4_CLOSE       |

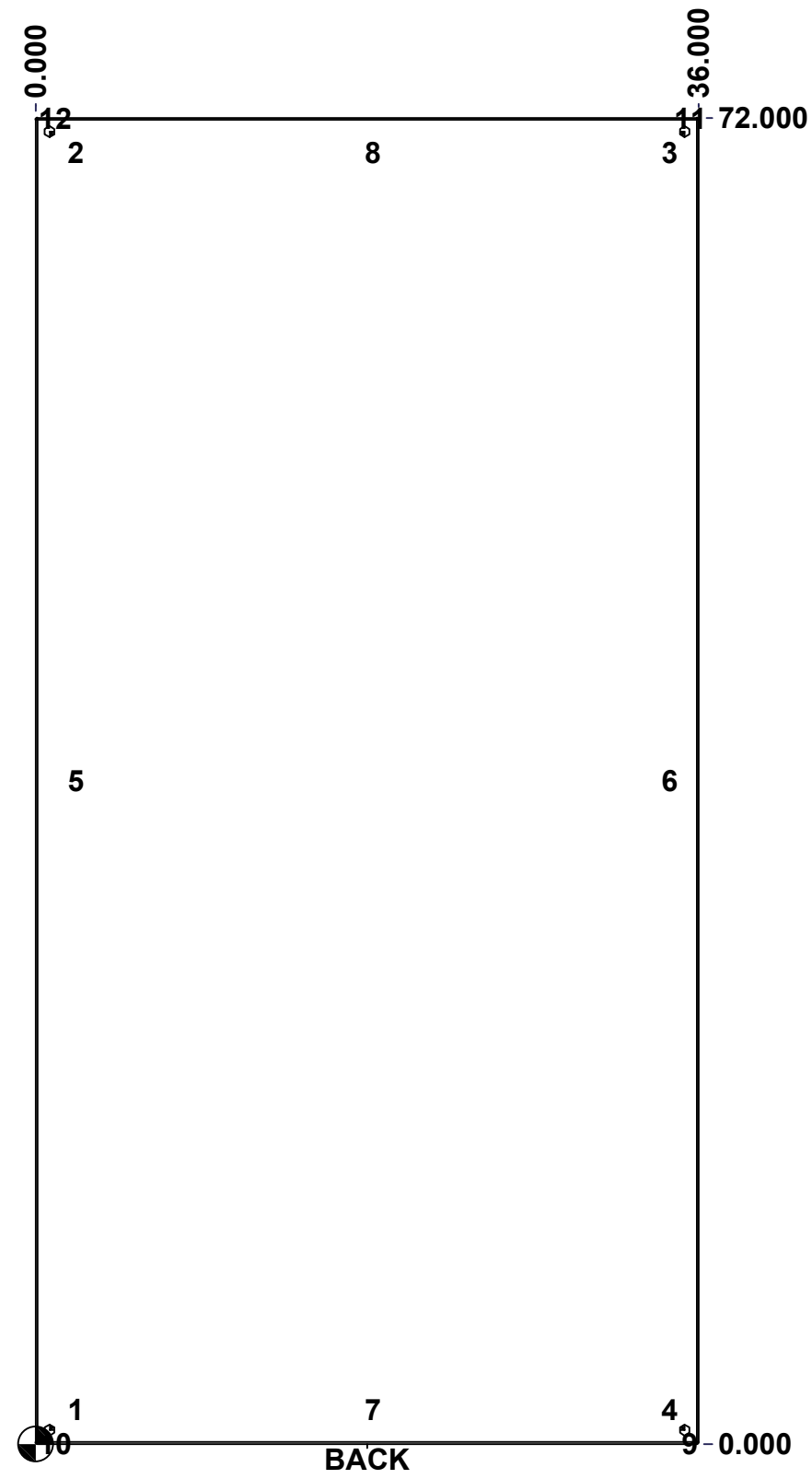

|  |                              |              |
|--|------------------------------|--------------|
|  | Description                  | Status       |
|  | 5412ESS 72" x 36" x 16" Body | (NULL)       |
|  | Part Number<br>Numéro Pièce  | Rev.         |
|  | <b>5412ESS7236166THB</b>     | <b>0</b> / 6 |
|  |                              | 16           |

This drawing is confidential and must not be reproduced or used without the consent of EXM

Ce dessin est confidentiel et ne doit pas être reproduit ou utilisé sans le consentement de EXM

| No. | Revisions | Date | By/Par |
|-----|-----------|------|--------|
|     |           |      |        |
|     |           |      |        |
|     |           |      |        |
|     |           |      |        |
|     |           |      |        |

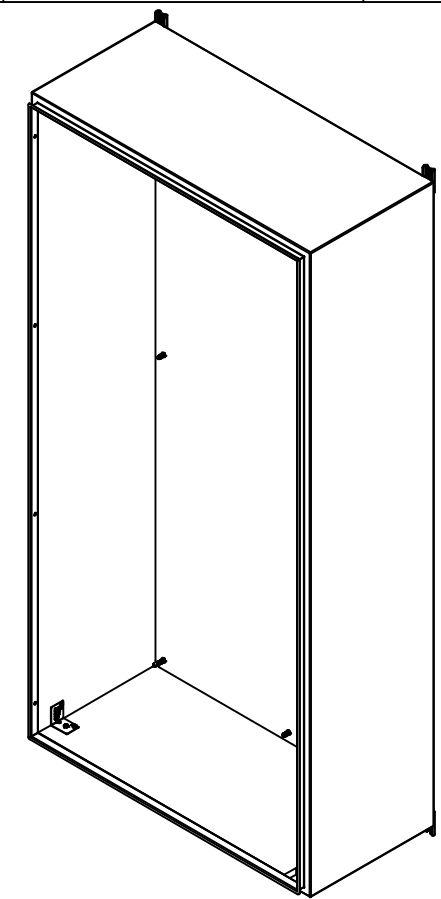

Isometric View

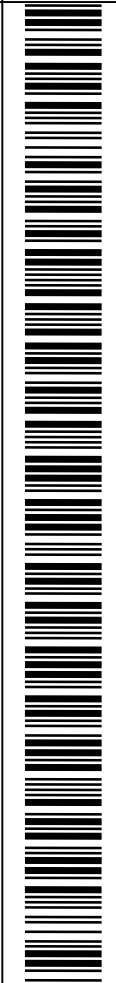

|   |                        |   |   |
|---|------------------------|---|---|
| 2 | 885ESMF4-FEET          | 0 | 885 ESMF4 Stainless Steel Mounting Foot               |
| 4 | RIVET_NUT_SS_M10_FH_CE | 0 | Stainless Steel Rivet Nut M10 (Low Profile Close End) |
| 4 | STK-Q-06670            | 2 | M10 x 16mm Stainless Steel Machine Screw              |
| 2 | 885ESMF4-FEET-A        | 0 | 885 ESMF4 Stainless Steel Mounting Foot (Opened Slot) |
| 1 | STK-K-70554            | 3 | 5412 ESTH Accessory Kit                               |
| 1 | 5412ESS7236166THI-RS   | 0 | 5412ESS 72" x 36" Right Insulation                    |
| 1 | 5412ESS7236166THI-LS   | 0 | 5412ESS 72" x 36" Left Insulation                     |
| 1 | 5412ESS7236166THI-BT   | 0 | 5412ESS 72" x 36" Top and Bottom Insulation           |
| 1 | 5412ESS7236166THI-TP   | 0 | 5412ESS 72" x 36" Top and Bottom Insulation           |
| 1 | 5412ESS7236166THI-B    | 0 | 5412ESS 72" x 36" Back Insulation                     |
| 4 | STK-Q-16070            | 1 | Stud M6 x 18mm Stainless steel                        |
| 8 | STK-Q-16020            | 1 | Stud M8 x 35mm Stainless Steel                        |
| 1 | 5412ESS7236166THB-P    | 0 | 5412ESS 72" x 36" x 16" Body Part                     |

| Qty        | Part Number | Rev | Description |
|------------|-------------|-----|-------------|
| Parts List |             |     |             |



Tél: (450) 979-4373  
Fax: (450) 979-4626  
[www.exmweb.com](http://www.exmweb.com)

Flatness  
Aplatissement  
Max 3.0mm

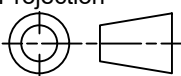
Projection  

Customer Client  
Date

Drawn By / Dessiné Par: BoxCad: BoxCad  
Date: 17-May-23

Material / Matière: 14 Ga Stainless Steel 316 (1.7mm)

Color / Couleur: Unpainted  
Finish / Fini: Brushed

Description: 5412ESS 72" x 36" x 16" Body  
Detail Rev.

Part Number / Numéro Pièce: **5412ESS7236166THB**  
Rev. 0

|    |
|----|
| 7  |
| 16 |

This drawing is confidential and must not be reproduced or used without the consent of EXM

Ce dessin est confidentiel et ne doit pas être reproduit ou utilisé sans le consentement de EXM

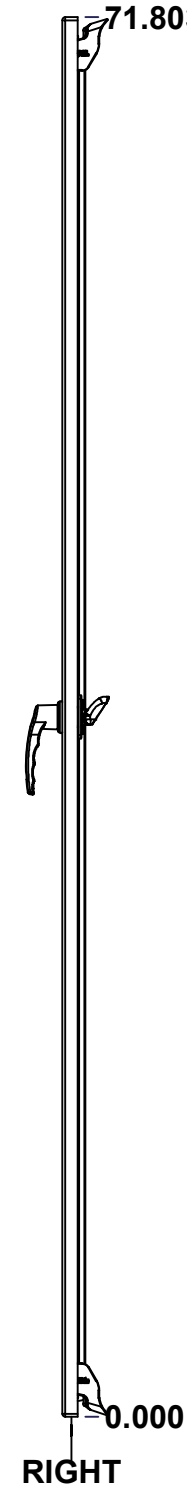
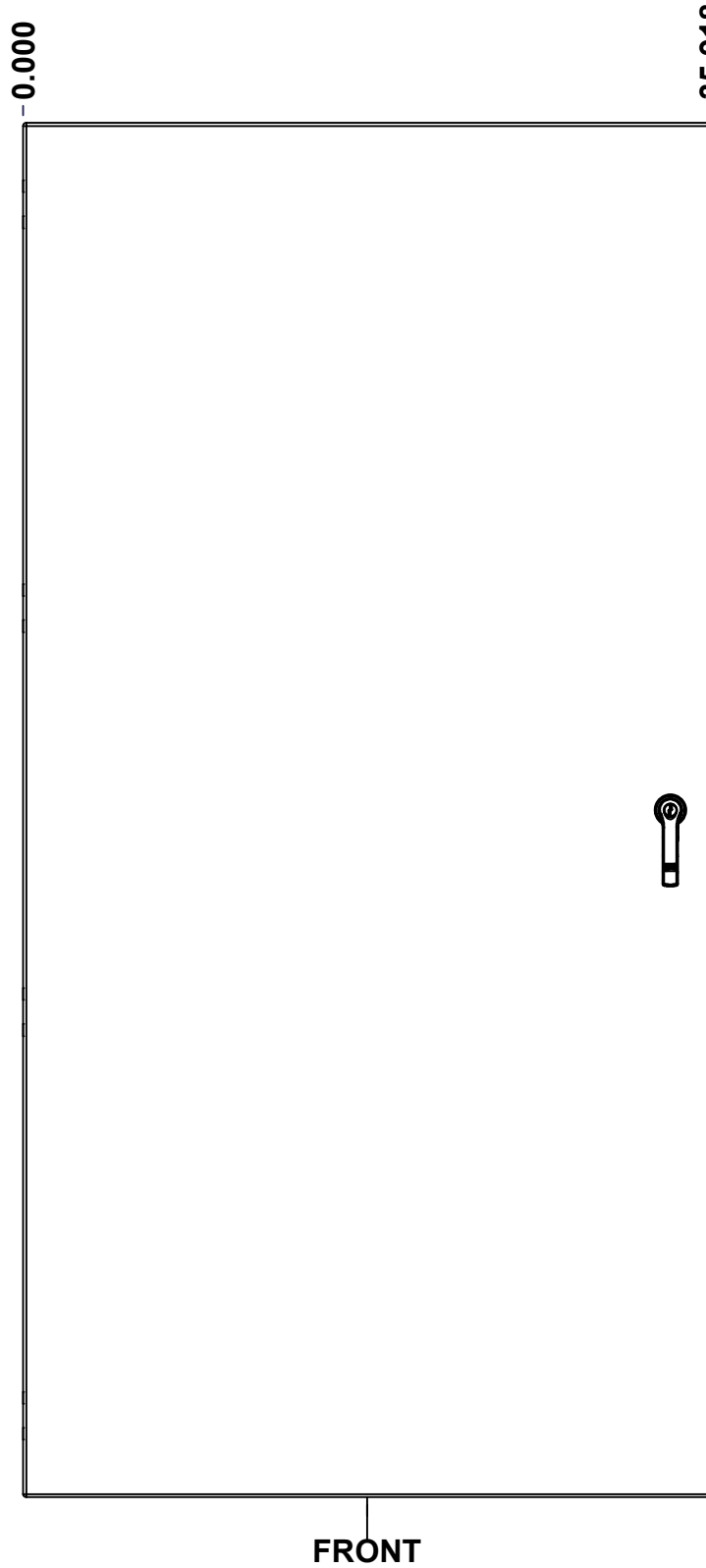
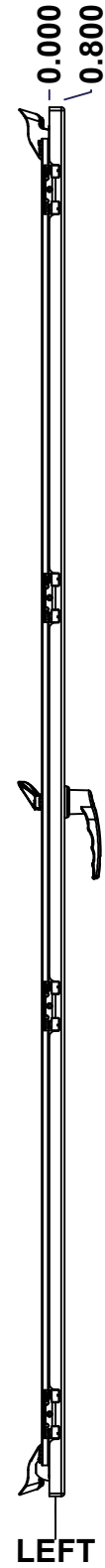
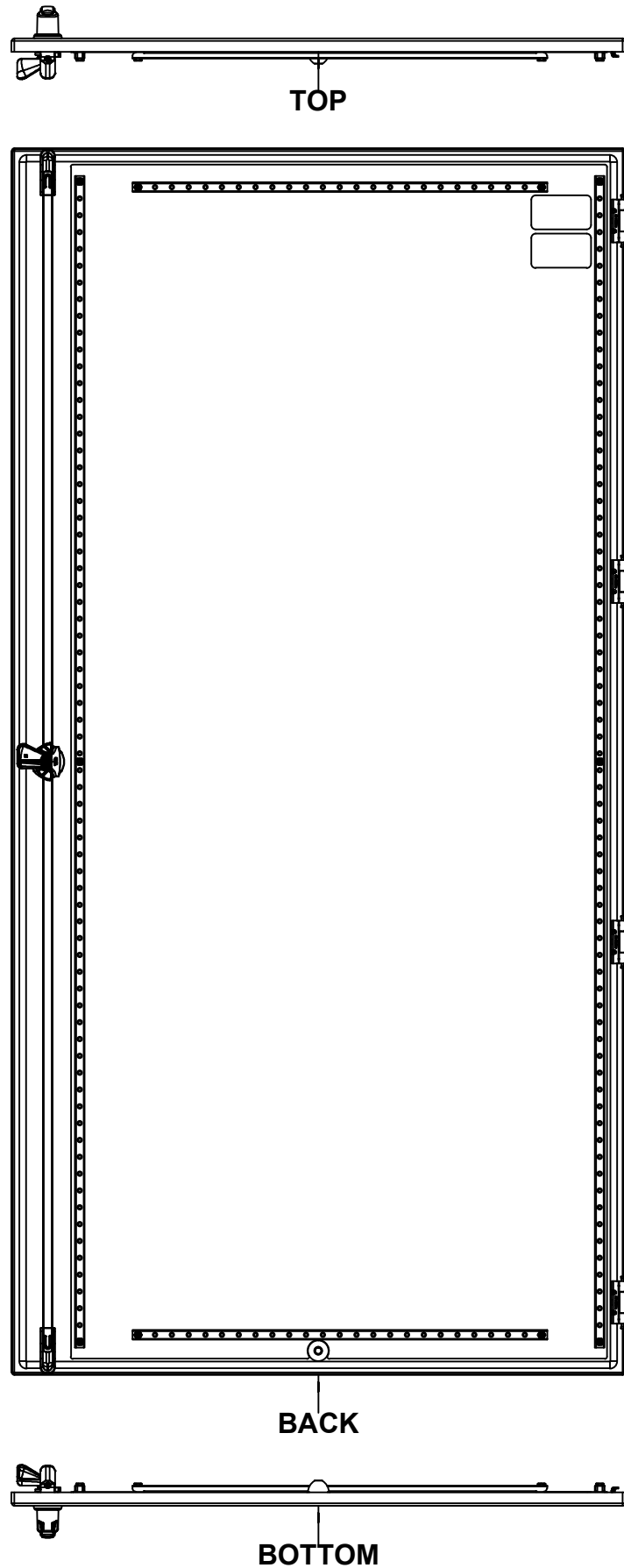

| No. | Revisions | Date | By/Par |
|-----|-----------|------|--------|
|     |           |      |        |
|     |           |      |        |
|     |           |      |        |
|     |           |      |        |
|     |           |      |        |

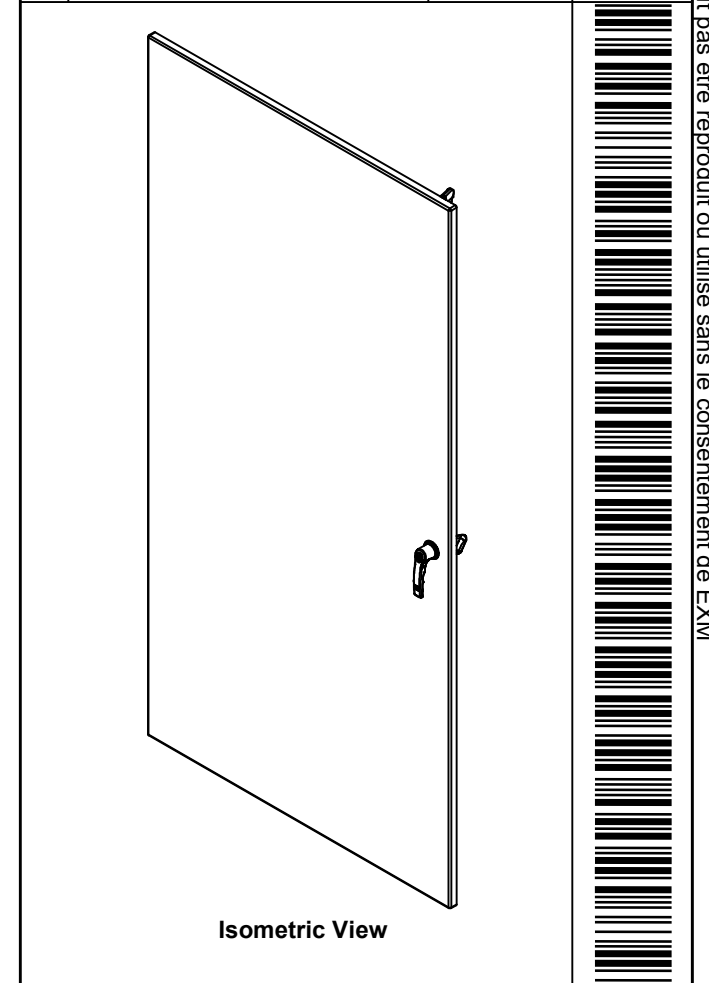

|   |  |
|---|--|
|   | Flatness<br>Aplatissement<br>Max 3.0mm |
|   | Projection<br>                         |
| Customer Client                                       | Date                                   |
| Drawn By<br>Dessiné Par BoxCad: BoxCad                | Date 17-May-23                         |
| Material<br>Matière 14 Ga Stainless Steel 316 (1.7mm) |  |
| Color<br>Couleur Unpainted                            | Finish<br>Fini Brushed                 |
| Description<br>5412ESS 72" x 36" Cover                |  |
| Part Number<br>Numéro Pièce <b>5412ESS7236166THC</b>  | Detail Rev.<br>Rev. 8<br><b>0</b>      |

**SEE BILL OF MATERIAL ON LAST PAGE**



This drawing is confidential and must not be reproduced or used without the consent of EXM

Ce dessin est confidentiel et ne doit pas être reproduit ou utilisé sans le consentement de EXM

**STANDARD FEATURES ARE NOT LISTED IN THIS HOLE TABLE**

**HOLE TABLE - FRONT VIEW (CUSTOM FEATURE ONLY)**

| CUT-OUT | XDIM   | YDIM   | DESCRIPTION               |
|---------|--------|--------|---------------------------|
| 1       | 1.486  | 1.945  | STUD M6 x 18mm (Inside)   |
| 2       | 1.486  | 69.858 | STUD M6 x 18mm (Inside)   |
| 3       | 31.923 | 69.858 | STUD M6 x 18mm (Inside)   |
| 4       | 31.923 | 1.945  | STUD M6 x 18mm (Inside)   |
| 5       | 1.486  | 35.902 | STUD M6 x 18mm (Inside)   |
| 6       | 31.923 | 35.902 | STUD M6 x 18mm (Inside)   |
| 7       | 4.893  | 2.350  | STUD M6 x 18mm (Inside)   |
| 8       | 4.893  | 69.524 | STUD M6 x 18mm (Inside)   |
| 9       | 28.516 | 69.524 | STUD M6 x 18mm (Inside)   |
| 10      | 28.516 | 2.350  | STUD M6 x 18mm (Inside)   |
| 11      | 33.803 | 66.896 | CLOSING BAR STUD (Inside) |
| 12      | 33.803 | 4.907  | CLOSING BAR STUD (Inside) |
| 13      | 17.959 | 1.435  | STUD M6 x 18mm (Inside)   |
| -----   | -----  | -----  | -----                     |
| 14      | 33.803 | 35.902 | 885 ESL2A-LSS             |

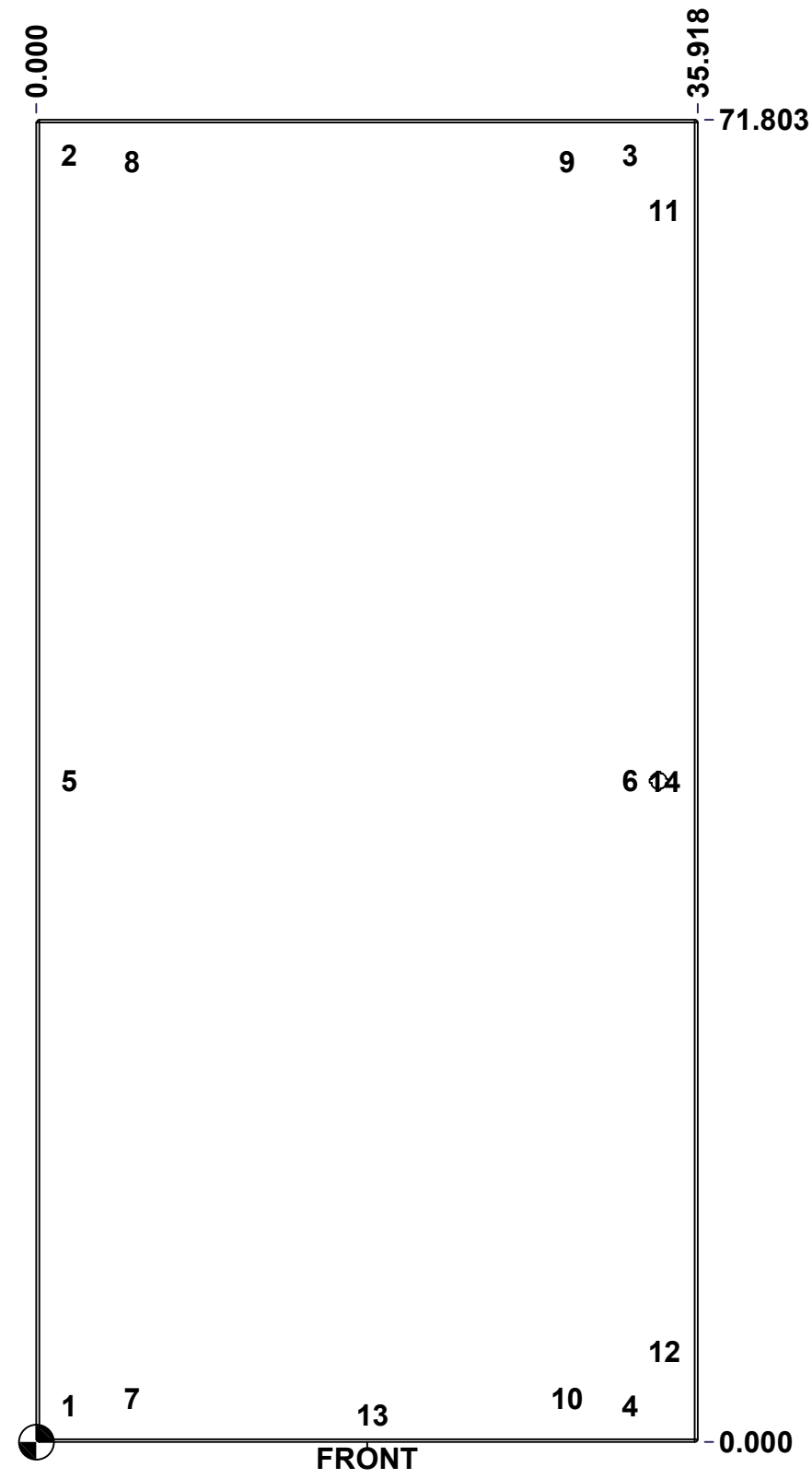

|  |                             |        |
|--|-----------------------------|--------|
|  | Description                 | Status |
|  | 5412ESS 72" x 36" Cover     | (NULL) |
|  | Part Number<br>Numéro Pièce | Rev.   |
|  | 5412ESS7236166THC           | 0      |
|  |                             | 9      |
|  |                             | 16     |

This drawing is confidential and must not be reproduced or used without the consent of EXM

Ce dessin est confidentiel et ne doit pas être reproduit ou utilisé sans le consentement de EXM

| No. | Revisions | Date | By/Par |
|-----|-----------|------|--------|
|     |           |      |        |
|     |           |      |        |
|     |           |      |        |
|     |           |      |        |
|     |           |      |        |

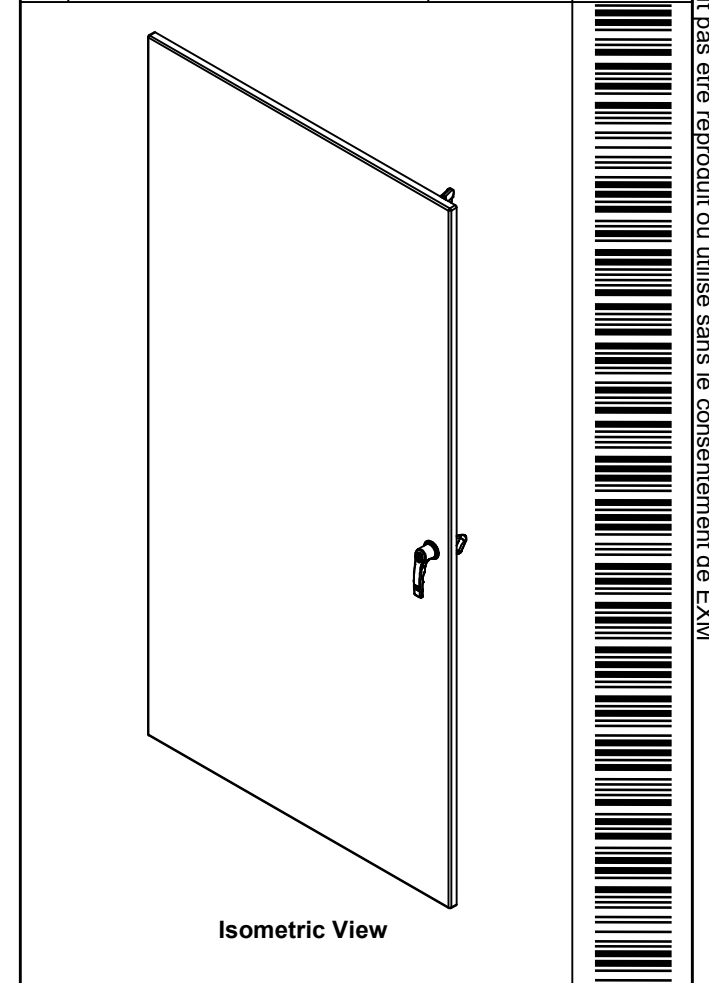

| 2          | STK-Q-90042         | 4   | 5412 ES - Cabinet Closing Bar End (Small)    |
|------------|---------------------|-----|--|
| 2          | STK-Q-45655-72      | 0   | 5412 ES - Closing Bar                        |
| 1          | STK-Q-50536         | 13  | 5412 ES - Handle Cam Clockwise (Grip 32mm)   |
| 1          | STK-Q-90051         | 3   | 5412 ES - Handle Cam Spacer                  |
| 1          | 885 ESL2A-LSS       | 3   | 5412 ESS Key Lock L-Handle (3 Pts)           |
| 2          | STK-S-00100         | 0   | 3.5" x 2" Silver Milar Flexcon Sticker       |
| 10         | STK-Q-07250         | 2   | M6 x 16mm Collar Nut                         |
| 2          | STK-Q-46025-30-3    | 4   | 5412 ES Horizontal Door Stiffener 30" (3Pts) |
| 2          | STK-Q-46020-72      | 5   | 5412 ES Vertical Door Stiffener 72"          |
| 1          | 5412ESS7236166THI-C | 0   | 5412ESS 72" x 36" Cover Insulation           |
| 1          | STK-Q-46515         | 3   | 5412 ES Door Support with Brass Insert       |
| 2          | STK-Q-16407         | 2   | Guide Stud - Small (No Paint Cap Required)   |
| 11         | STK-Q-16070         | 1   | Stud M6 x 18mm Stainless steel               |
| 1          | 5412ESS7236166THG   | 0   | 5412ESS 72" x 36" Cover Gasket Part          |
| 1          | 5412ESS7236166THC-P | 0   | 5412ESS 72" x 36" Cover Part                 |
| 4          | STK-A-33016         | 0   | 5412 ESS Bended Hinge (Body Part)            |
| QTY        | Part Number         | Rev | Description                                  |
| Parts List |                     |     |  |

|  |                                   |
|--|-----------------------------------|
| Tél: (450) 979-4373<br>Fax: (450) 979-4626<br><a href="http://www.exmweb.com">www.exmweb.com</a> | Flatness<br>Aplatissement         |
|  | Max 3.0mm                         |
| Projection   |                                   |
| Customer<br>Client   | Date                              |
| Drawn By<br>Dessiné Par  | Date 17-May-23                    |
| Material<br>Matière  | 14 Ga Stainless Steel 316 (1.7mm) |
| Color<br>Couleur   | Unpainted                         |
| Finish<br>Fini   | Brushed                           |
| Description  | Detail Rev.                       |
| 5412ESS 72" x 36" Cover  |                                   |
| Part Number<br>Numéro Pièce  | Rev. 10                           |
| <b>5412ESS7236166THC</b>   | <b>0</b> 16                       |

This drawing is confidential and must not be reproduced or used without the consent of EXM

Ce dessin est confidentiel et ne doit pas être reproduit ou utilisé sans le consentement de EXM

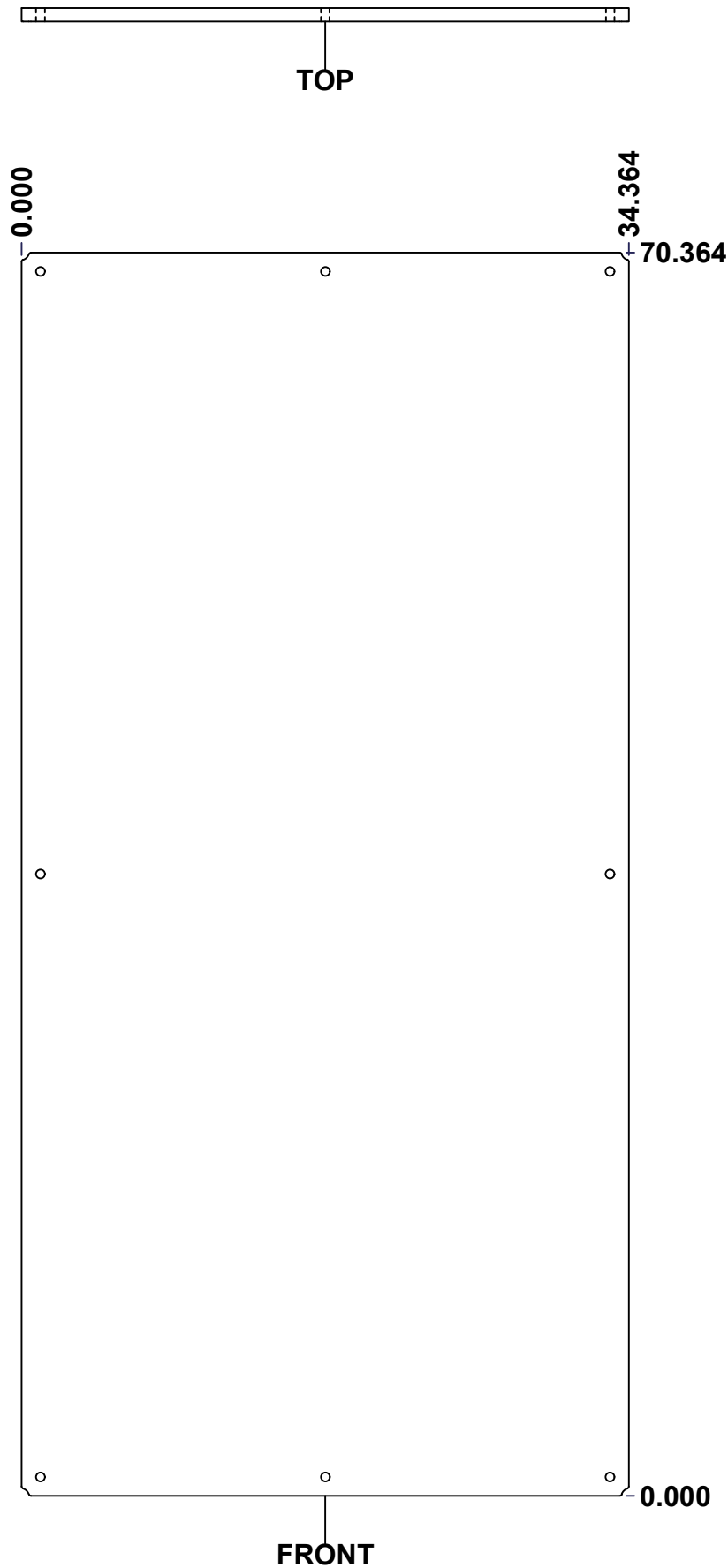

| No. | Revisions | Date | By/Par |
|-----|-----------|------|--------|
|     |           |      |        |
|     |           |      |        |
|     |           |      |        |
|     |           |      |        |

**Isometric View**

|   |          |                           |             |
|---|----------|---------------------------|-------------|
| <p>Tél: (450) 979-4373<br/>Fax: (450) 979-4626<br/><a href="http://www.exmweb.com">www.exmweb.com</a></p> |          | Flatness<br>Aplatissement |             |
|   |          | Max 3.0mm                 |             |
| Customer<br>Client  |          | Date                      |             |
| Drawn By<br>Dessiné Par   |          | Date 23-Jan-07            |             |
| Material<br>Matière   |          | Polyisocyanurate          |             |
| Color<br>Couleur  | Aluminum | Finish<br>Fini            | N/A         |
| Description   |          |                           | Detail Rev. |
| 5412ESS 72" x 36" Back Insulation   |          |                           |             |
| Part Number<br>Numéro Pièce   |          | Rev.                      | 11          |
| 5412ESS7236166THI-B   |          | 0                         | 16          |

**SEE BILL OF MATERIAL ON LAST PAGE**

This drawing is confidential and must not be reproduced or used without the consent of EXM

Ce dessin est confidentiel et ne doit pas être reproduit ou utilisé sans le consentement de EXM

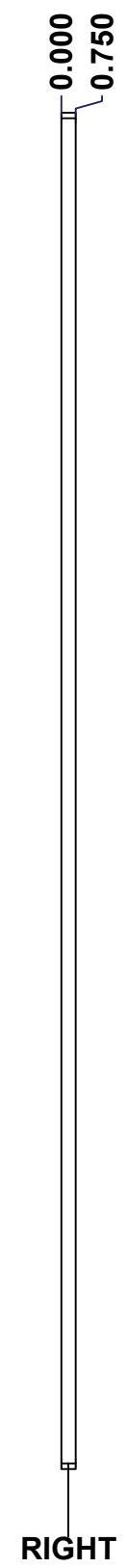
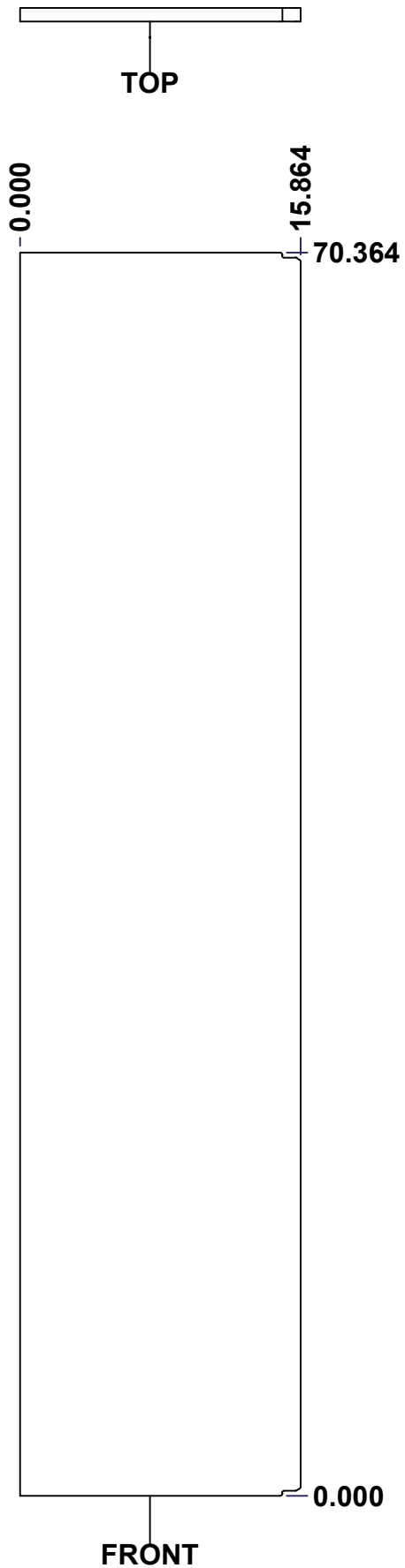

| No. | Revisions | Date | By/Par |
|-----|-----------|------|--------|
|     |           |      |        |
|     |           |      |        |
|     |           |      |        |
|     |           |      |        |

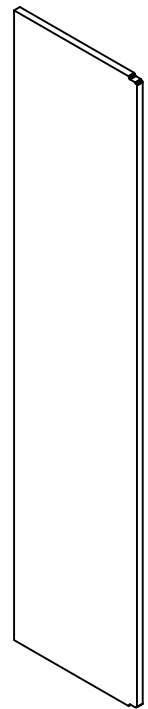

**Isometric View**



|  |          |                           |             |
|--|----------|---------------------------|-------------|
|  Tél: (450) 979-4373<br>Fax: (450) 979-4626<br><a href="http://www.exmweb.com">www.exmweb.com</a> |          | Flatness<br>Aplatissement |             |
|  |          | Max 3.0mm                 |             |
| Customer<br>Client   |          | Date                      |             |
| Drawn By<br>Dessiné Par  |          | Date 23-Jan-07            |             |
| Material<br>Matière  |          | Polyisocyanurate          |             |
| Color<br>Couleur   | Aluminum | Finish<br>Fini            | N/A         |
| Description  |          |                           | Detail Rev. |
| 5412ESS 72" x 36" Left Insulation  |          |                           |             |
| Part Number<br>Numéro Pièce  |          | Rev.                      | 12          |
| 5412ESS7236166THI-LS   |          | 0                         | 16          |

**SEE BILL OF MATERIAL ON LAST PAGE**

This drawing is confidential and must not be reproduced or used without the consent of EXM

Ce dessin est confidentiel et ne doit pas être reproduit ou utilisé sans le consentement de EXM

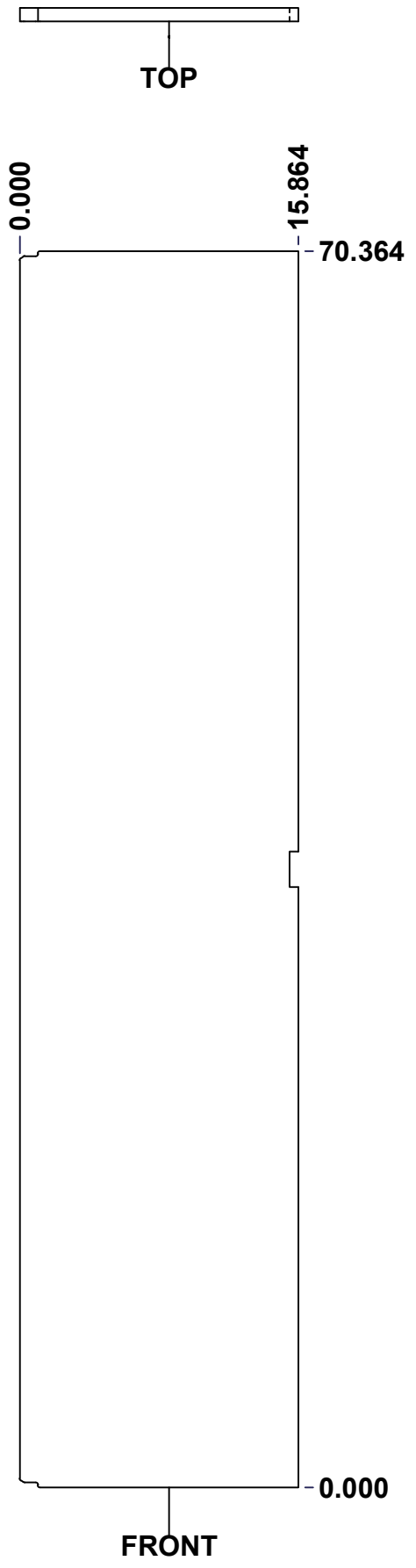

| No. | Revisions | Date | By/Par |
|-----|-----------|------|--------|
|     |           |      |        |
|     |           |      |        |
|     |           |      |        |
|     |           |      |        |
|     |           |      |        |

**Isometric View**

|  |          |                           |             |
|--|----------|---------------------------|-------------|
| Tél: (450) 979-4373<br>Fax: (450) 979-4626<br><a href="http://www.exmweb.com">www.exmweb.com</a> |          | Flatness<br>Aplatissement |             |
|  |          | Max 3.0mm                 |             |
| Customer<br>Client   |          | Date                      |             |
| Drawn By<br>Dessiné Par  |          | Date 23-Jan-07            |             |
| Material<br>Matière  |          | Polyisocyanurate          |             |
| Color<br>Couleur   | Aluminum | Finish<br>Fini            | N/A         |
| Description  |          |                           | Detail Rev. |
| 5412ESS 72" x 36" Right Insulation   |          |                           |             |
| Part Number<br>Numéro Pièce  |          | Rev.                      | 13          |
| 5412ESS7236166THI-RS   |          | 0                         | 16          |

**SEE BILL OF MATERIAL ON LAST PAGE**

This drawing is confidential and must not be reproduced or used without the consent of EXM

Ce dessin est confidentiel et ne doit pas être reproduit ou utilisé sans le consentement de EXM

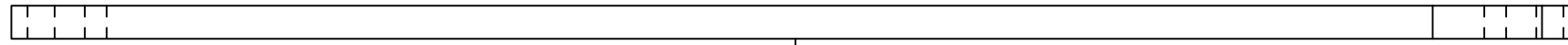

TOP

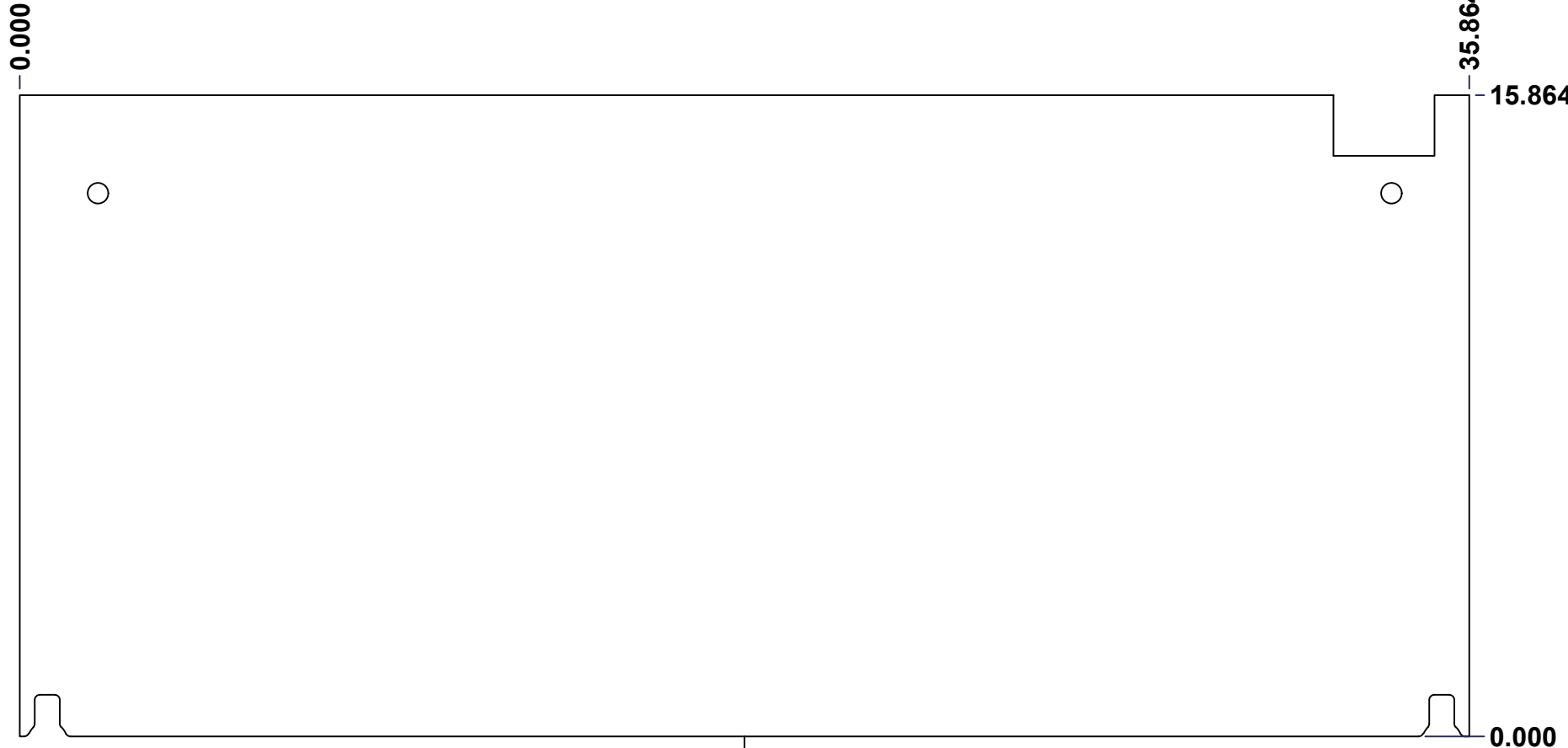

FRONT

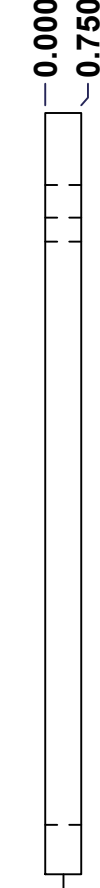

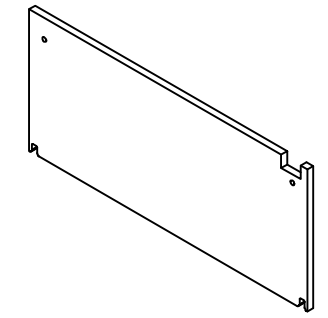

RIGHT

| No. | Revisions | Date | By/Par |
|-----|-----------|------|--------|
|     |           |      |        |
|     |           |      |        |
|     |           |      |        |
|     |           |      |        |
|     |           |      |        |

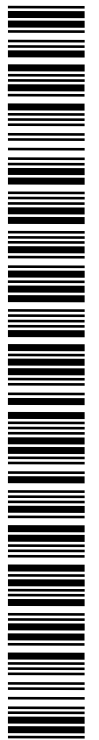

**Isometric View**

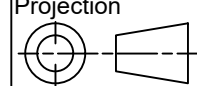

|  |                           |                           |
|--|---------------------------|---------------------------|
|  Tél: (450) 979-4373<br>Fax: (450) 979-4626<br><a href="http://www.exmweb.com">www.exmweb.com</a> |                           | Flatness<br>Aplatissement |
|  |                           | Max 3.0mm                 |
| Projection    |                           |                           |
| Customer<br>Client   |                           | Date                      |
| Drawn By<br>Dessiné Par  | BoxCad: Patrick Deschenes | Date 23-Jan-07            |
| Material<br>Matière  | Polyisocyanurate          |                           |
| Color<br>Couleur   | Aluminum                  | Finish<br>Fini N/A        |
| Description  | Detail Rev.               |                           |
| 5412ESS 72" x 36" Top and Bottom Insulation  |                           |                           |
| Part Number<br>Numéro Pièce  | Rev. 0                    | 14 / 16                   |
| <b>5412ESS7236166THI-TP</b>  |                           |                           |

SEE BILL OF MATERIAL ON LAST PAGE

This drawing is confidential and must not be reproduced or used without the consent of EXM

Ce dessin est confidentiel et ne doit pas être reproduit ou utilisé sans le consentement de EXM

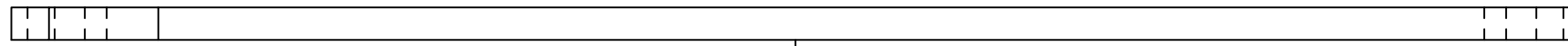

TOP

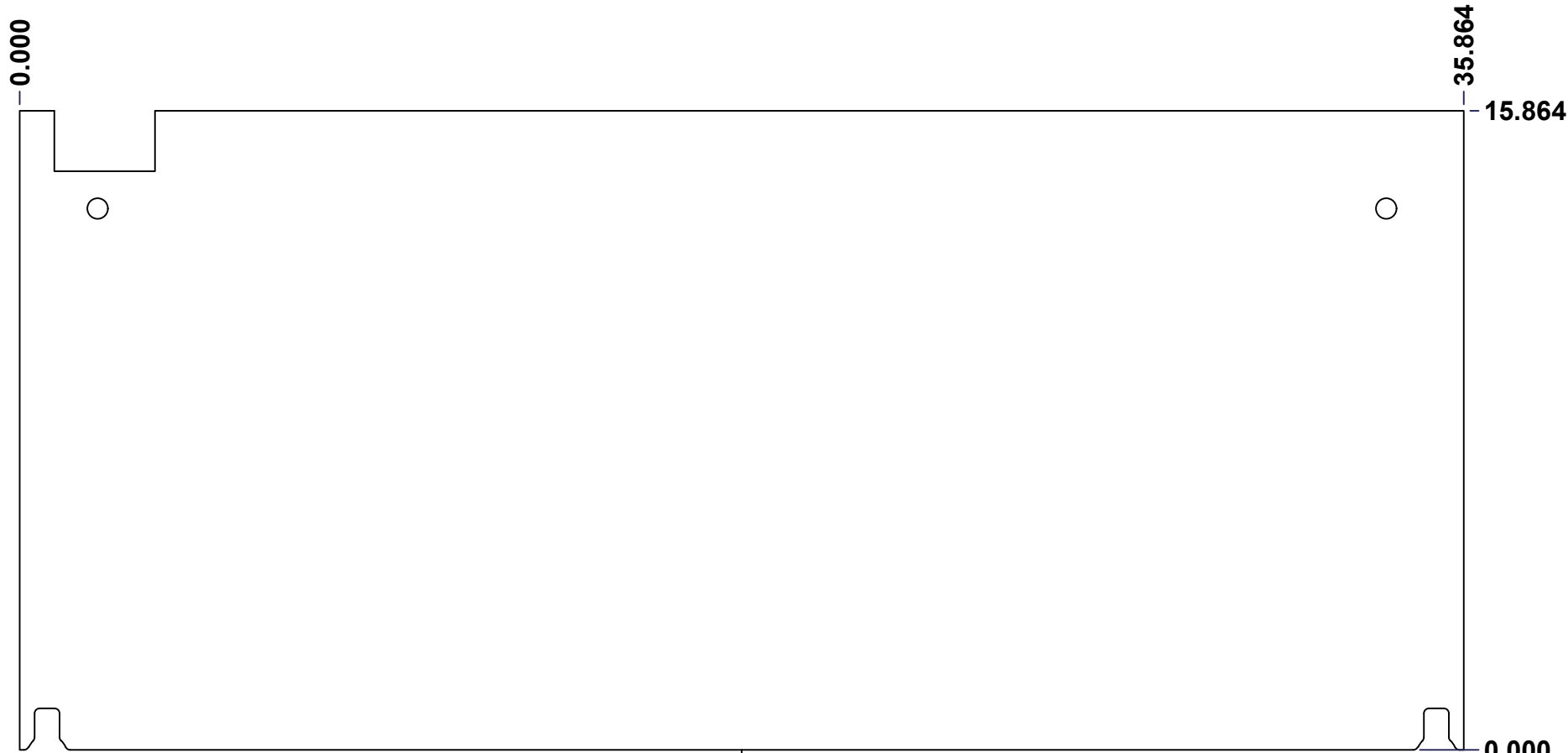

FRONT

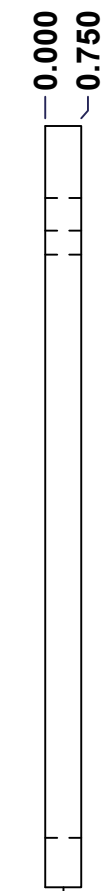

RIGHT

| No. | Revisions | Date | By/Par |
|-----|-----------|------|--------|
|     |           |      |        |
|     |           |      |        |
|     |           |      |        |
|     |           |      |        |
|     |           |      |        |

**Isometric View**

|   |  |                           |             |
|---|--|---------------------------|-------------|
| <p>Tél: (450) 979-4373<br/>Fax: (450) 979-4626<br/><a href="http://www.exmweb.com">www.exmweb.com</a></p> |  | Flatness<br>Aplatissement |             |
|   |  | Max 3.0mm                 |             |
| Customer<br>Client  |  | Date                      |             |
| Drawn By<br>Dessiné Par   |  | Date                      |             |
| Material<br>Matière   |  | Polyisocyanurate          |             |
| Color<br>Couleur  |  | Finish<br>Fini            |             |
| Aluminum  |  | N/A                       |             |
| Description<br>5412ESS 72" x 36" Top and Bottom<br>Insulation   |  |                           | Detail Rev. |
| Part Number<br>Numéro Pièce   |  | Rev.                      | 15          |
| 5412ESS7236166THI-BT  |  | 0                         | 16          |

SEE BILL OF MATERIAL ON LAST PAGE

This drawing is confidential and must not be reproduced or used without the consent of EXM

Ce dessin est confidentiel et ne doit pas être reproduit ou utilisé sans le consentement de EXM

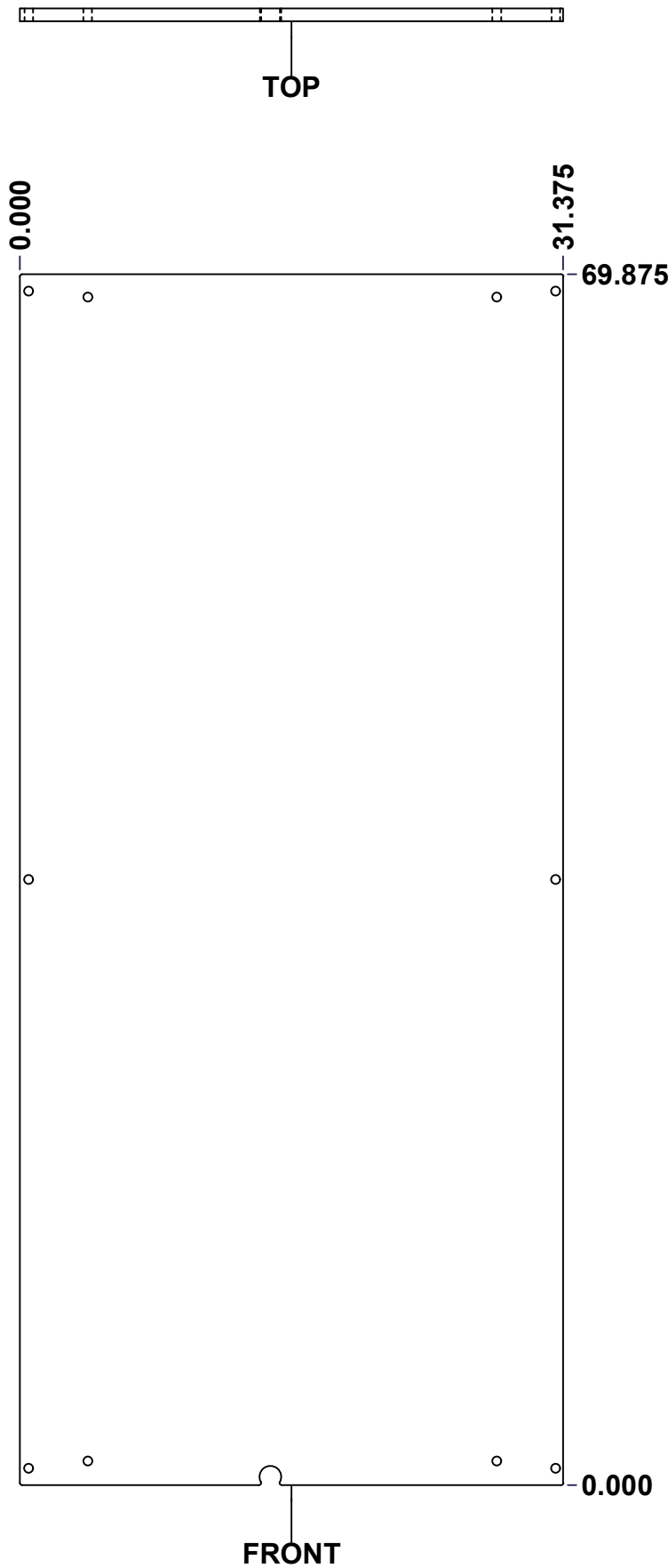

| No. | Revisions | Date | By/Par |
|-----|-----------|------|--------|
|     |           |      |        |
|     |           |      |        |
|     |           |      |        |
|     |           |      |        |
|     |           |      |        |

**Isometric View**

|   |                           |                           |
|---|---------------------------|---------------------------|
| <p>Tél: (450) 979-4373<br/>Fax: (450) 979-4626<br/><a href="http://www.exmweb.com">www.exmweb.com</a></p> |                           | Flatness<br>Aplatissement |
|   |                           | Max 3.0mm                 |
|   |                           | Projection                |
| Customer<br>Client  | Date                      |                           |
| Drawn By<br>Dessiné Par   | BoxCad: Patrick Deschenes | Date 23-Jan-07            |
| Material<br>Matière   | Polyisocyanurate          |                           |
| Color<br>Couleur  | Aluminum                  | Finish<br>Fini N/A        |
| Description   | Detail Rev.               |                           |
| 5412ESS 72" x 36" Cover Insulation  |                           |                           |
| Part Number<br>Numéro Pièce   | Rev.                      | 16                        |
| <b>5412ESS7236166THI-C</b>  | <b>0</b>                  | 16                        |

**SEE BILL OF MATERIAL ON LAST PAGE**



This drawing is confidential and must not be reproduced or used without the consent of EXM

Ce dessin est confidentiel et ne doit pas être reproduit ou utilisé sans le consentement de EXM

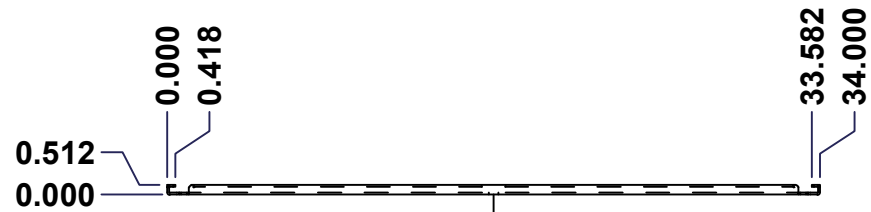

TOP

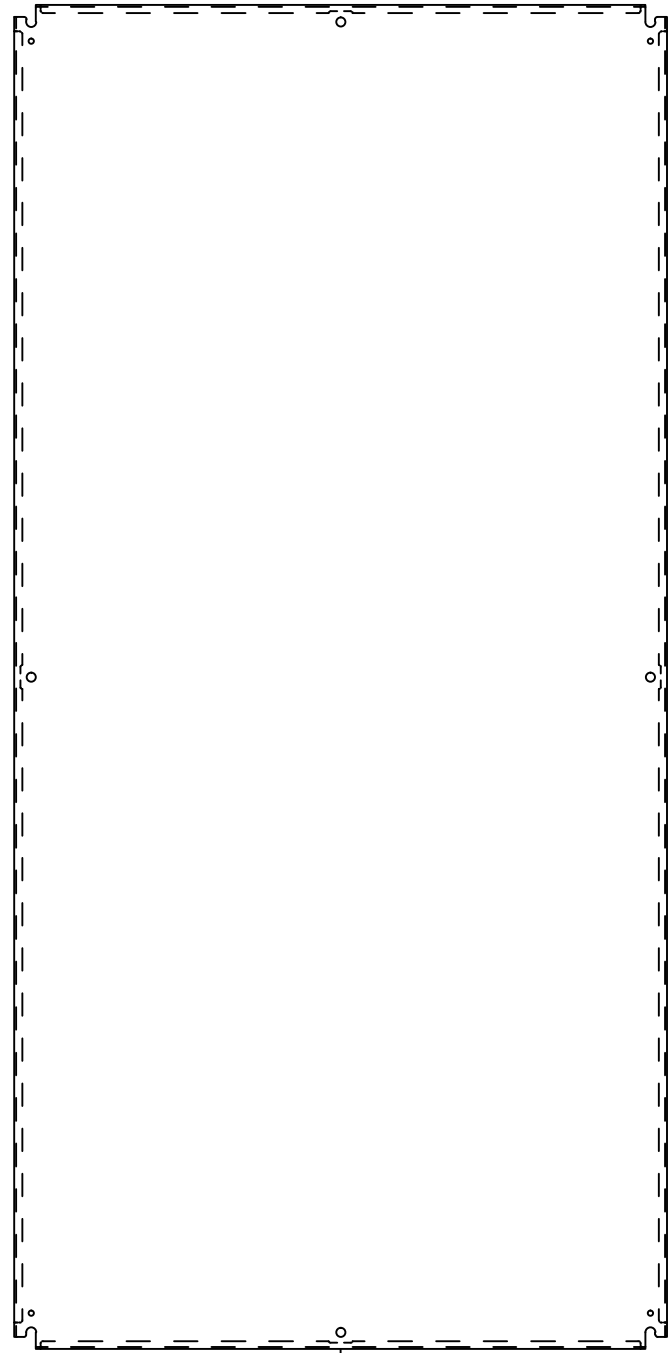

FRONT

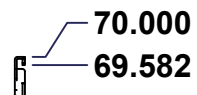

RIGHT

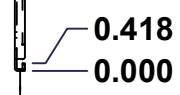

| No. | Revisions | Date | By/Par |
|-----|-----------|------|--------|
|     |           |      |        |
|     |           |      |        |
|     |           |      |        |
|     |           |      |        |
|     |           |      |        |

Isometric View

|  |                              |                           |
|--|------------------------------|---------------------------|
| Tél: (450) 979-4373<br>Fax: (450) 979-4626<br>www.exmweb.com |                              | Flatness<br>Aplatissement |
|  |                              | Max 3.0mm                 |
| Projection<br>   |                              |                           |
| Customer Client  |                              | Date                      |
| Drawn By / Dessiné Par: BoxCad                               |                              | Date: 23-Jan-07           |
| Material / Matière: See Part List                            |                              |                           |
| Color / Couleur: See Part List                               | Finish / Fini: See Part List |                           |
| Description: 881 SP - Inner Panel                            |                              | Detail Rev.               |
| Part Number / Numéro Pièce: <b>881 SP7236G</b>               |                              | Rev. 1/2                  |

| Qty | Part Number   | Rev | Description               | Material         | Color     | Finish     |
|-----|---------------|-----|---------------------------|------------------|-----------|------------|
| 1   | 881 SP7236G-P | 0   | 881 SP - Inner Panel Part | 12 Ga Galvanized | Unpainted | Galvanized |

Parts List

This drawing is confidential and must not be reproduced or used without the consent of EXM

Ce dessin est confidentiel et ne doit pas être reproduit ou utilisé sans le consentement de EXM

| Table 1 |        |        | FRONT VIEW                 |
|---------|--------|--------|----------------------------|
| CUT-OUT | XDIM   | YDIM   | DESCRIPTION                |
| 1       | 17.000 | 0.875  | MTG STUD HOLE (RND Ø0.500) |
| 2       | 0.875  | 35.000 | MTG STUD HOLE (RND Ø0.500) |
| 3       | 33.125 | 35.000 | MTG STUD HOLE (RND Ø0.500) |
| 4       | 17.000 | 69.125 | MTG STUD HOLE (RND Ø0.500) |
| 5       | 0.875  | 1.875  | GROUND HOLE (RND Ø0.290)   |
| 6       | 33.125 | 1.875  | GROUND HOLE (RND Ø0.290)   |
| 7       | 0.875  | 68.125 | GROUND HOLE (RND Ø0.290)   |
| 8       | 33.125 | 68.125 | GROUND HOLE (RND Ø0.290)   |

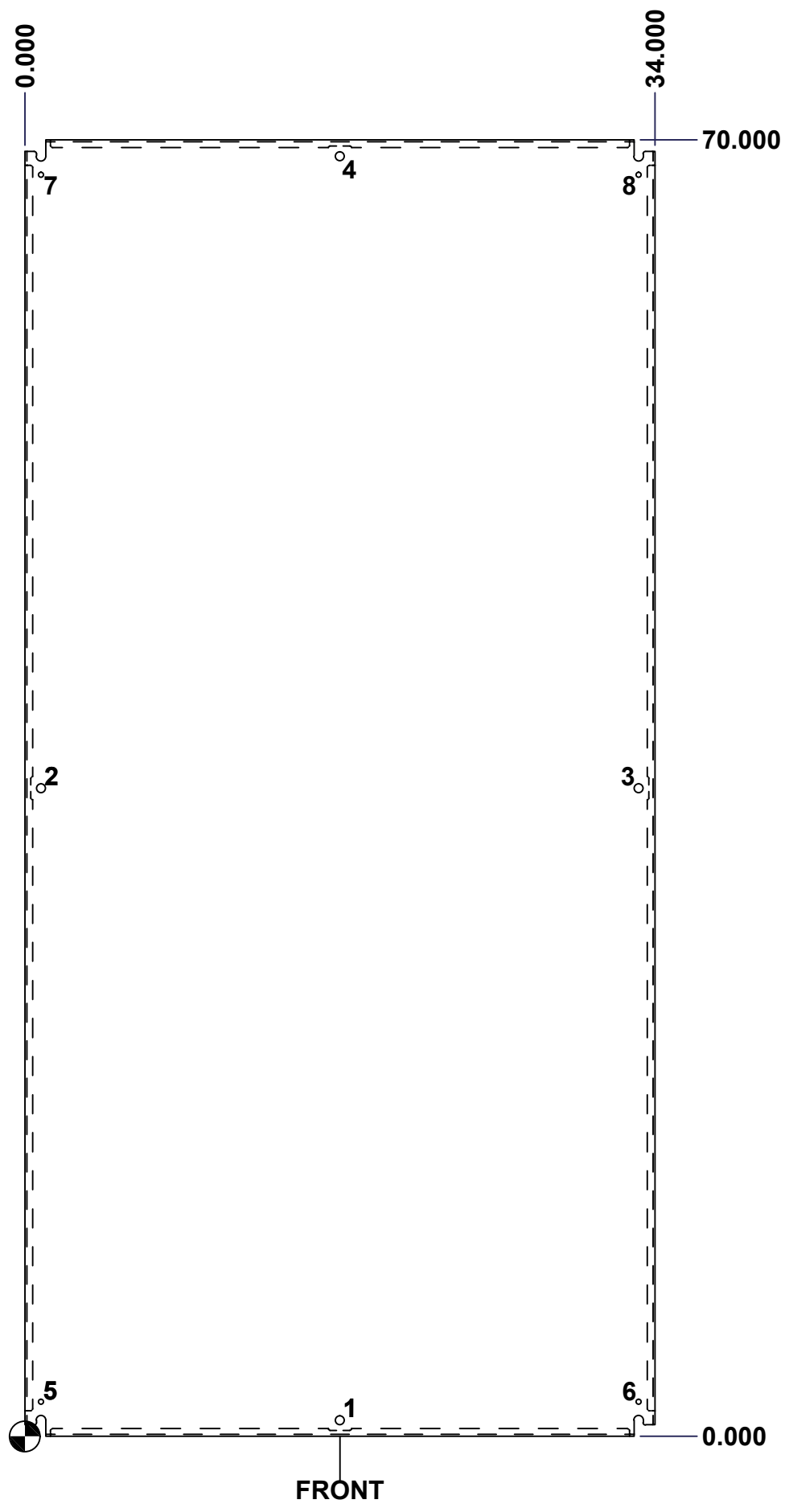

All knockouts are actual size / Les disques défonçables sont grandeur réel

| No. | Revisions | Date | By/Par |
|-----|-----------|------|--------|
|     |           |      |        |
|     |           |      |        |
|     |           |      |        |
|     |           |      |        |
|     |           |      |        |

Isometric View

|   |  |  |  |  |  |
|---|--|--|--|--|--|
|   |  | Tél: (450) 979-4373<br>Fax: (450) 979-4626<br>www.exmweb.com |  | Flatness<br>Aplatissement<br>Max 3.0mm |  |
| Customer<br>Client                                |  | Date   |  | Projection<br>                         |  |
| Drawn By<br>Dessiné Par BoxCad                    |  | Date 23-Jan-07   |  | Material<br>Matière See Part List      |  |
| Color<br>Couleur See Part List                    |  | Finish<br>Fini See Part List                                 |  | Description<br>881 SP - Inner Panel    |  |
| Part Number<br>Numéro Pièce<br><b>881 SP7236G</b> |  | Rev.<br><b>0</b>   |  | Detail Rev.<br>2 / 2                   |  |