

This drawing is confidential and must not be reproduced or used without the consent of EXM

Ce dessin est confidentiel et ne doit pas être reproduit ou utilisé sans le consentement de EXM

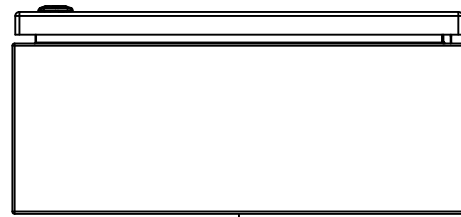

TOP

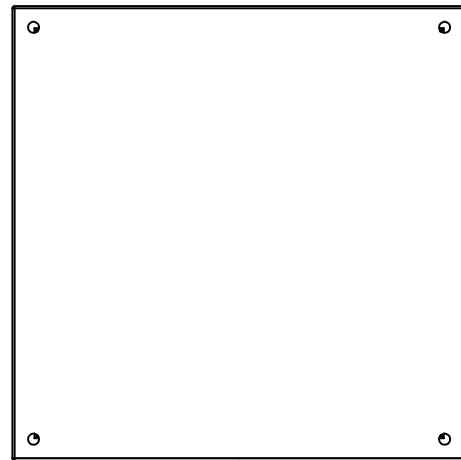

BACK

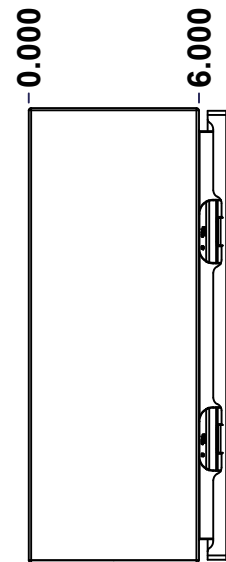

LEFT

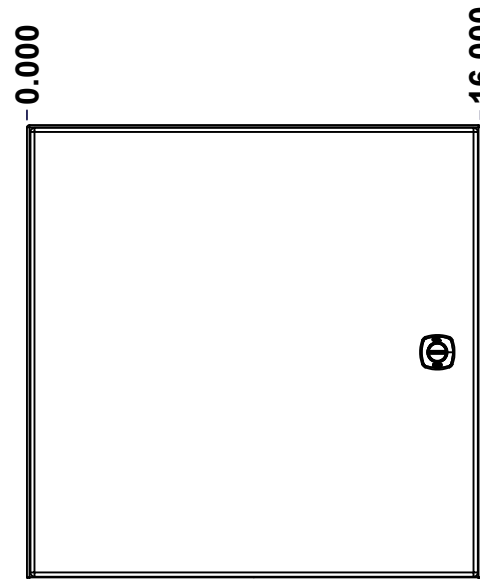

FRONT

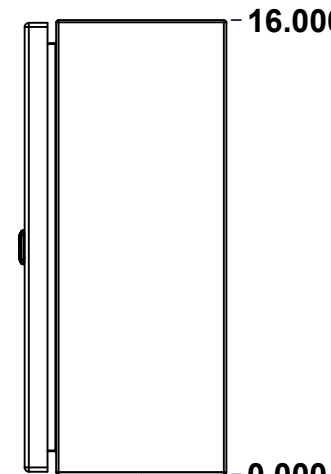

RIGHT

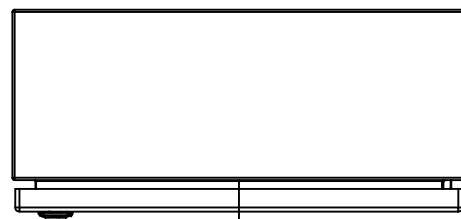

BOTTOM

**GRAIN DIRECTION:
TOP/BOTTOM: HORIZONTAL
LEFT/RIGHT/BACK/FRONT: VERTICAL**

SEE BILL OF MATERIAL ON LAST PAGE

No.	Revisions	Date	By/Par

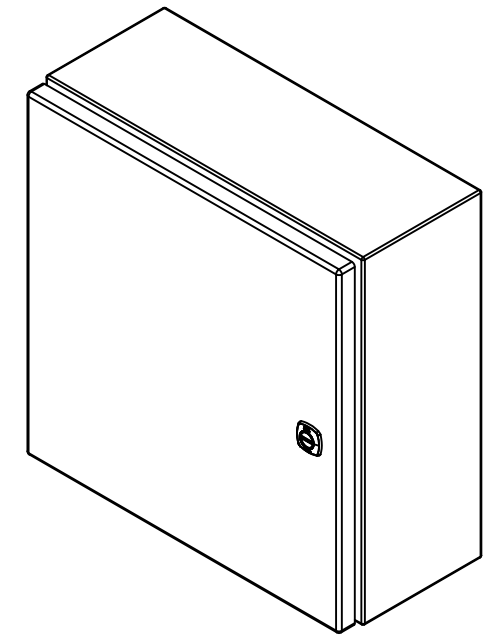

Isometric View



Tél: (450) 979-4373
Fax: (450) 979-4626
www.exmweb.com

Flatness
Aplatissement

Max 3.0mm

Projection

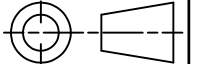

Customer Client	Date
Drawn By Dessiné Par BoxCad: BoxCad	Date 08-May-14
Material Matière 16 Ga Stainless Steel 304 (1.4mm)	
Color Couleur Unpainted	Finish Fini Brushed
Description 5412ESSBU 16" x 16" x 6" Assembly	Detail Rev.
Part Number Numéro Pièce 5412ESSBU161606	Rev. 1 0 2

This drawing is confidential and must not be reproduced or used without the consent of EXM

Ce dessin est confidentiel et ne doit pas être reproduit ou utilisé sans le consentement de EXM

NOTE	
ITEM	DESCRIPTION
1	NEMA 4X Enclosure
2	C/W Standard ground studs on box and cover
3	C/W Standard door stiffener
4	C/W Standard inner panel (Included)
5	C/W Standard inner panel mounting studs

No.	Revisions	Date	By/Par

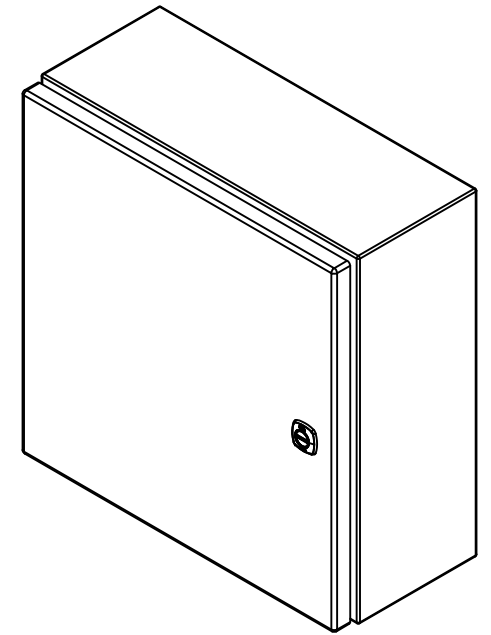

Isometric View

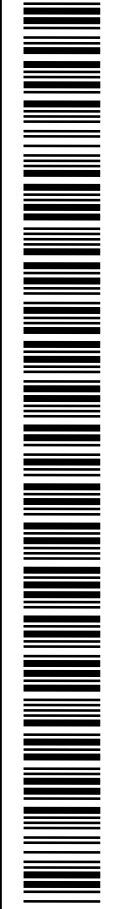

Tél: (450) 979-4373
 Fax: (450) 979-4626
www.exmweb.com

Flatness
Aplatissement
Max 3.0mm
Projection

Customer Client	Date
Drawn By Dessiné Par BoxCad: BoxCad	Date 08-May-14
Material Matière	16 Ga Stainless Steel 304 (1.4mm)

Color Couleur	Unpainted	Finish Fini	Brushed
------------------	-----------	----------------	---------

Description	Detail Rev.
5412ESSBU 16" x 16" x 6" Assembly	

Part Number Numéro Pièce	Rev.	2
5412ESSBU161606	0	2

Qty	Part Number	Rev	Description
1	880 PP	6	Self Adhesive Print Pocket
1	STK-K-01800	5	5412 ES Accessory Kit
1	881 SP1616G	0	881 SP - Inner Panel
1	5412ESSBU161606C	0	5412ESSBU 16" x 16" Cover
4	STK-Q-07310	2	Flange Lock Nut M8
4	STK-Q-07610	8	M8 Plastic Spacer 22.2mm
1	5412ESSBU161606B	0	5412ESSBU 16" x 16" x 6" Body
4	STK-Q-04051-07	8	M6 x 7mm Stainless Steel Hexagon Socket Head Machine Screw with Nyseal
Parts List			

PACKING		
ITEM	QTY	DESCRIPTION
Cardboard sleeve	2	Top and Bottom
Cardboard strip	2	Between back of enclosure and inner panel
Plastic bag	1	To protect cover surface and inside gasket
Plastic strap - Black	2	To Squeeze the 2 cardboard sleeve together
Packaging label	1	White label with product number

This drawing is confidential and must not be reproduced or used without the consent of EXM

Ce dessin est confidentiel et ne doit pas être reproduit ou utilisé sans le consentement de EXM

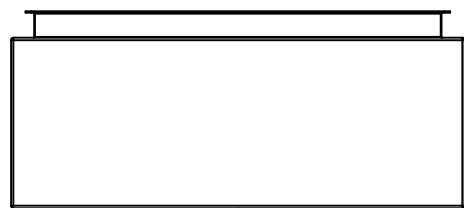

TOP

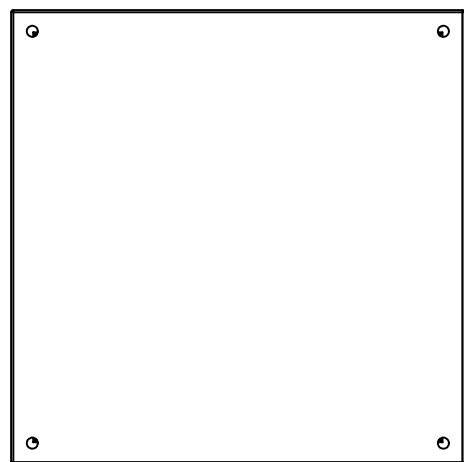

BACK

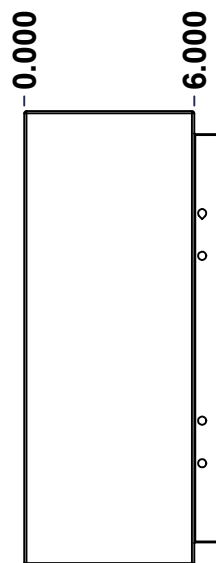

LEFT

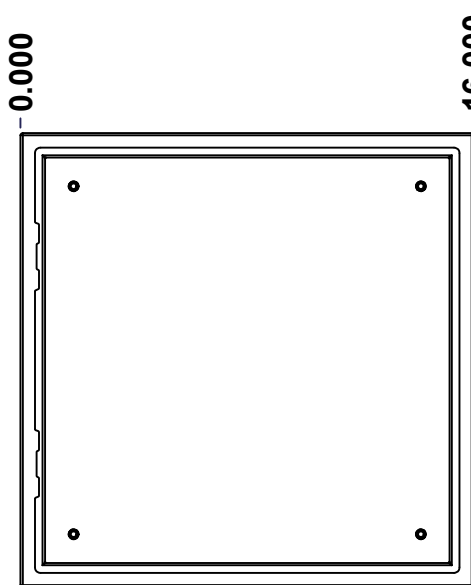

FRONT

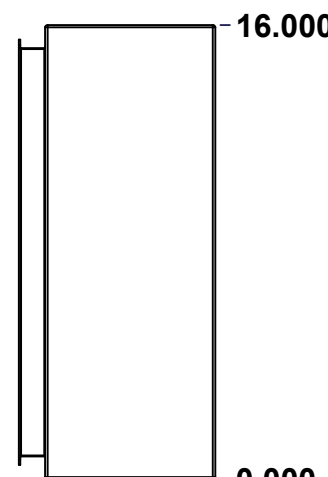

RIGHT

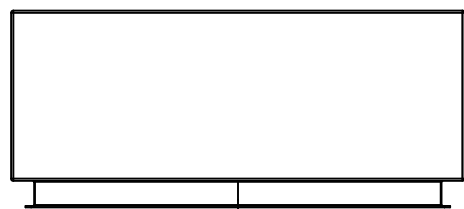

BOTTOM

No.	Revisions	Date	By/Par

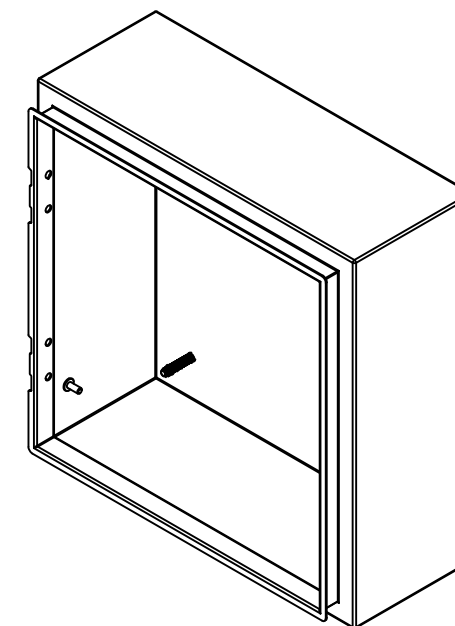

Isometric View



Tél: (450) 979-4373
 Fax: (450) 979-4626
www.exmweb.com

Flatness
Aplatissement

Max 3.0mm

Projection



Customer Client	Date
Drawn By / Dessiné Par: BoxCad: BoxCad	Date: 08-May-14

Material / Matière: 16 Ga Stainless Steel 304 (1.4mm)

Color / Couleur: Unpainted	Finish / Fini: Brushed
----------------------------	------------------------

Description: 5412ESSBU 16" x 16" x 6" Body	Detail Rev.
--------------------------------------------	-------------

Part Number / Numéro Pièce: 5412ESSBU161606B	Rev. 0	1 / 7
----------------------------------------------	--------	-------

SEE BILL OF MATERIAL ON LAST PAGE

This drawing is confidential and must not be reproduced or used without the consent of EXM

Ce dessin est confidentiel et ne doit pas être reproduit ou utilisé sans le consentement de EXM

STANDARD FEATURES ARE NOT LISTED IN THIS HOLE TABLE			
HOLE TABLE - LEFT VIEW (CUSTOM FEATURE ONLY)			
CUT-OUT	XDIM	YDIM	DESCRIPTION
1	4.500	2.000	GND STUD M6 x 16mm (Inside)

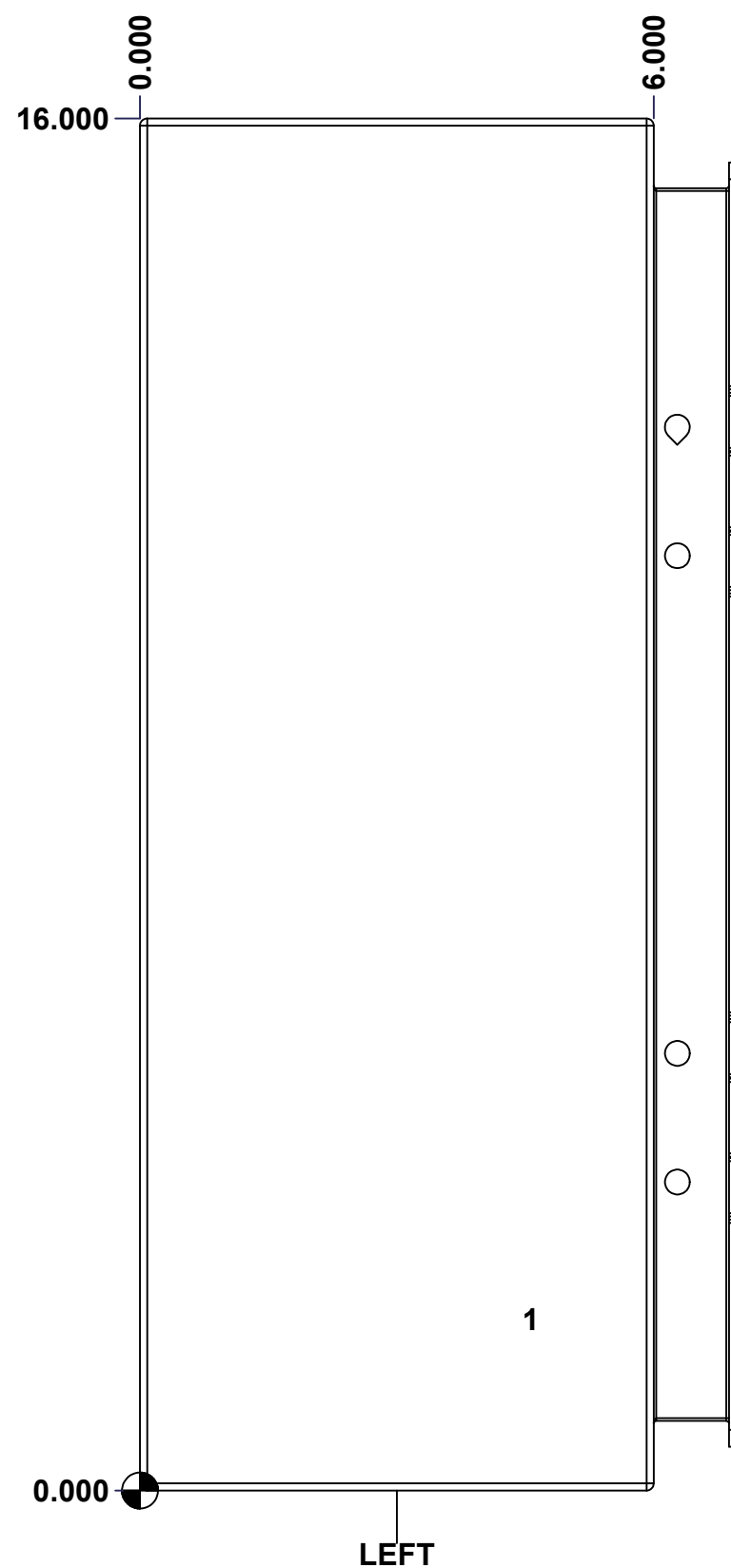

	Description		Status	
	5412ESSBU 16" x 16" x 6" Body			
Part Number Numéro Pièce		Rev.	5 / 7	
5412ESSBU161606B		0		

This drawing is confidential and must not be reproduced or used without the consent of EXM

Ce dessin est confidentiel et ne doit pas être reproduit ou utilisé sans le consentement de EXM

STANDARD FEATURES ARE NOT LISTED IN THIS HOLE TABLE			
HOLE TABLE - BACK VIEW (CUSTOM FEATURE ONLY)			
CUT-OUT	XDIM	YDIM	DESCRIPTION
1	1.875	1.875	IP STUD M8 x 35mm (Inside)
2	1.875	14.125	IP STUD M8 x 35mm (Inside)
3	14.125	14.125	IP STUD M8 x 35mm (Inside)
4	14.125	1.875	IP STUD M8 x 35mm (Inside)

5	15.250	0.750	RND Ø0.390
6	15.250	15.250	RND Ø0.390
7	0.750	15.250	RND Ø0.390
8	0.750	0.750	RND Ø0.390

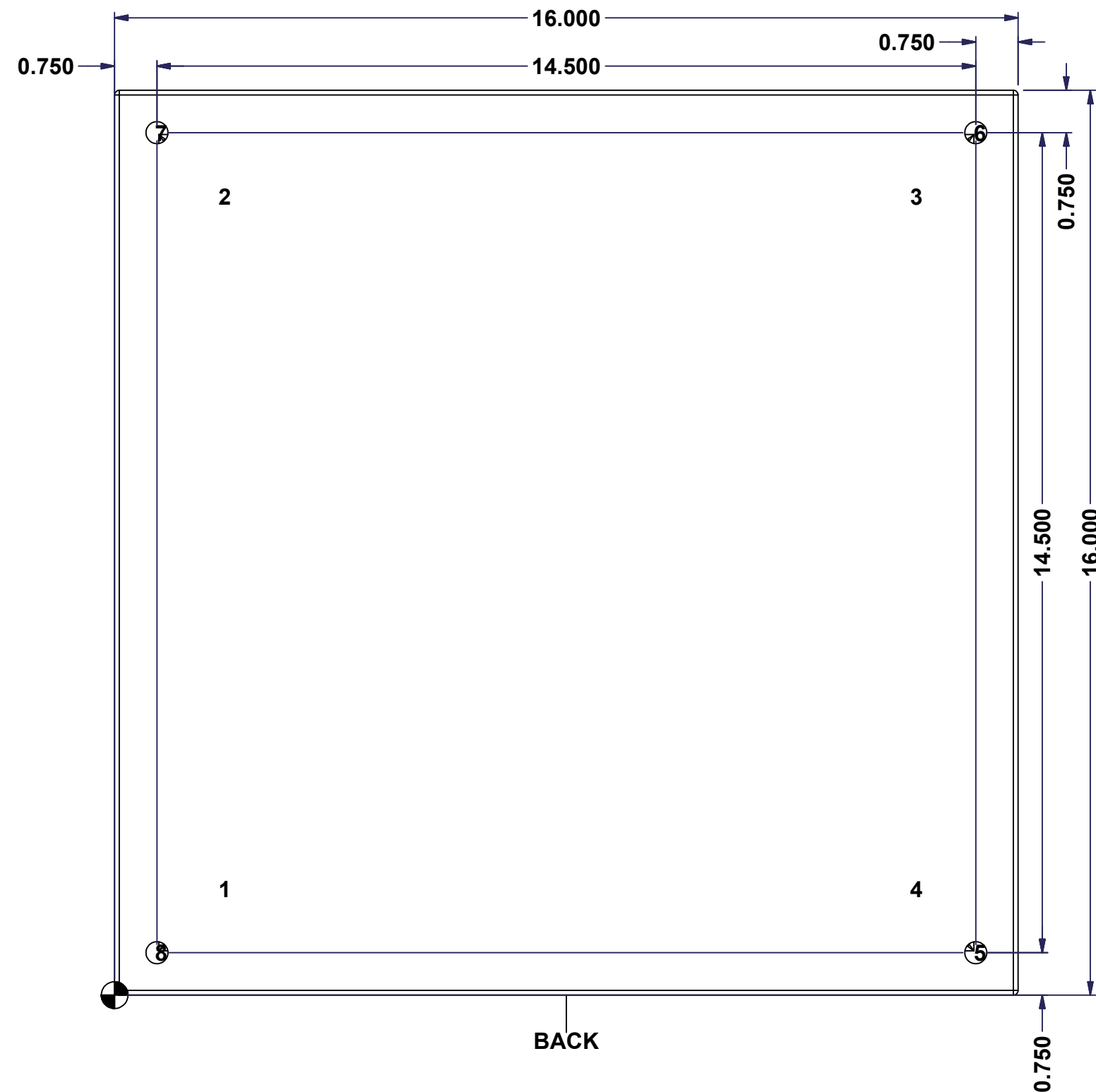

BACK

	Description	Status	
	5412ESSBU 16" x 16" x 6" Body		
	Part Number Numéro Pièce	Rev.	6
	5412ESSBU161606B	0	7

This drawing is confidential and must not be reproduced or used without the consent of EXM

Ce dessin est confidentiel et ne doit pas être reproduit ou utilisé sans le consentement de EXM

No.	Revisions	Date	By/Par

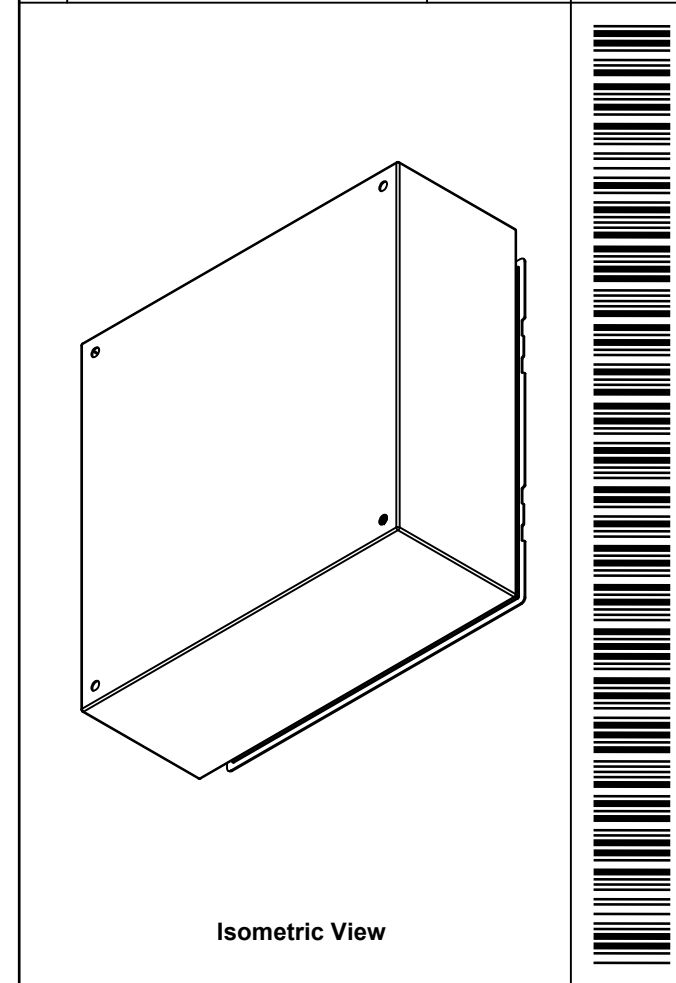

Isometric View

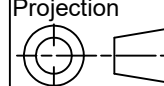

 Tél: (450) 979-4373 Fax: (450) 979-4626 www.exmweb.com		Flatness Aplatissement  Max 3.0mm Projection 
Customer Client	Date	
Drawn By Dessiné Par	BoxCad: BoxCad	Date 08-May-14
Material Matière	16 Ga Stainless Steel 304 (1.4mm)	
Color Couleur	Unpainted	Finish Fini Brushed
Description	Detail Rev.	
5412ESSBU 16" x 16" x 6" Body		
Part Number Numéro Pièce	Rev.	7
5412ESSBU161606B	0	7

Qty	Part Number	Rev	Description
1	STK-Q-16085	0	Ground Stud M6 x 16mm Stainless Steel
4	STK-Q-16020	1	Stud M8 x 35mm Stainless Steel
1	5412ESSBU161606B-P	0	5412ESSBU 16" x 16" x 6" Body Part
Parts List			

This drawing is confidential and must not be reproduced or used without the consent of EXM

Ce dessin est confidentiel et ne doit pas être reproduit ou utilisé sans le consentement de EXM

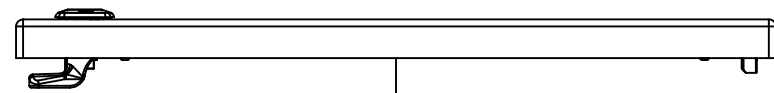

TOP

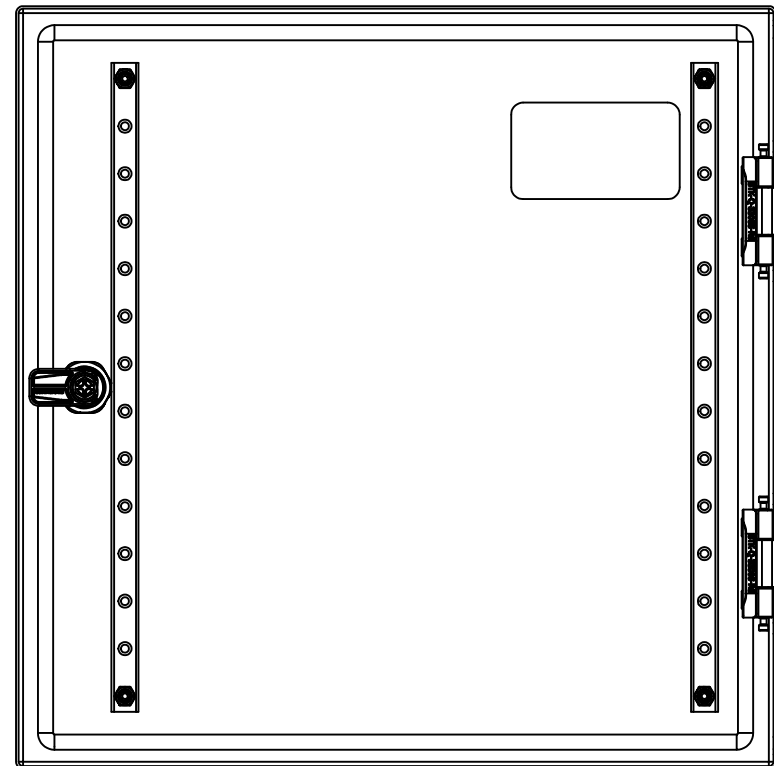

BACK

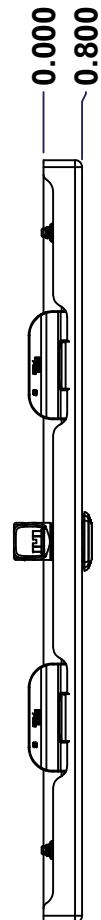

LEFT

0.000
0.800

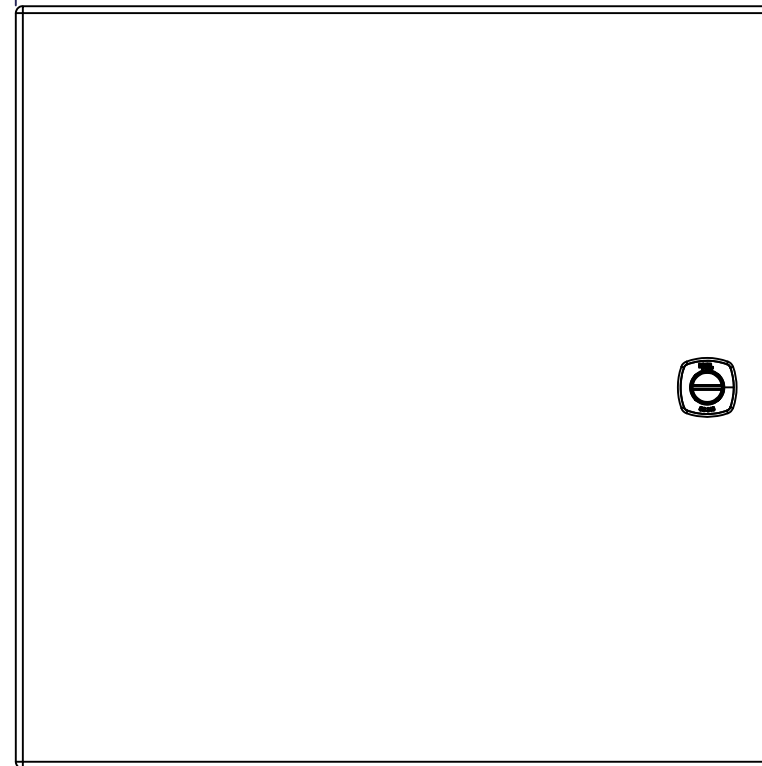

FRONT

0.000
15.778

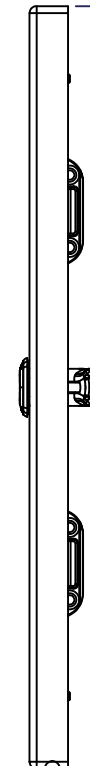

RIGHT

15.803

0.000

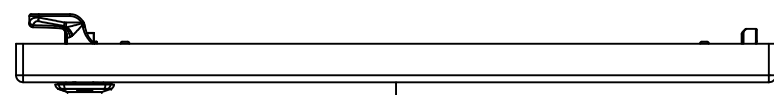

BOTTOM

No.	Revisions	Date	By/Par

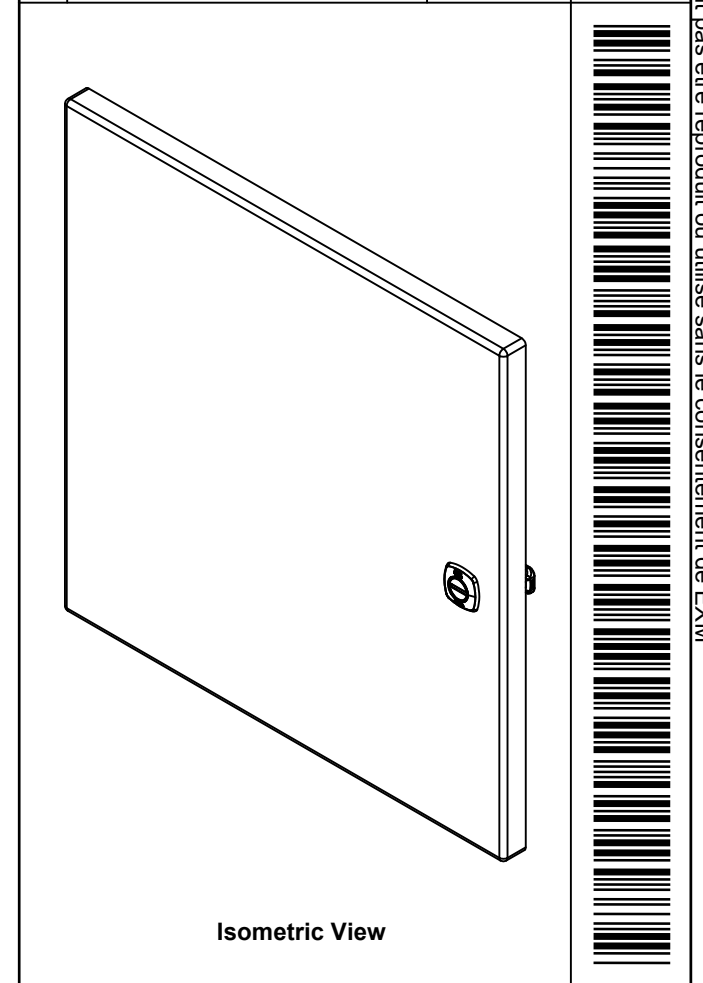

Isometric View

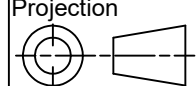

 Tél: (450) 979-4373 Fax: (450) 979-4626 www.exmweb.com		Flatness Aplatissement Max 3.0mm Projection 	
Customer Client		Date	
Drawn By / Dessiné Par: BoxCad: BoxCad		Date: 08-May-14	
Material / Matière: 16 Ga Stainless Steel 304 (1.4mm)		Color / Couleur: Unpainted	
Description: 5412ESSBU 16" x 16" Cover		Finish / Fini: Brushed	
Part Number / Numéro Pièce: 5412ESSBU161606C		Detail Rev.:	
SEE BILL OF MATERIAL ON LAST PAGE		Rev. 0	1 / 3

This drawing is confidential and must not be reproduced or used without the consent of EXM

Ce dessin est confidentiel et ne doit pas être reproduit ou utilisé sans le consentement de EXM

STANDARD FEATURES ARE NOT LISTED IN THIS HOLE TABLE

HOLE TABLE - FRONT VIEW (CUSTOM FEATURE ONLY)

CUT-OUT	XDIM	YDIM	DESCRIPTION
1	1.486	1.504	STUD M6 x 18mm (Inside)
2	1.486	14.299	STUD M6 x 18mm (Inside)
3	13.517	14.299	STUD M6 x 18mm (Inside)
4	13.517	1.504	STUD M6 x 18mm (Inside)

5	3.750	12.803	LABEL_EXM (Inside)
6	14.354	7.902	LOCK 880 SCQ4-SLSS6 @ 0.0°

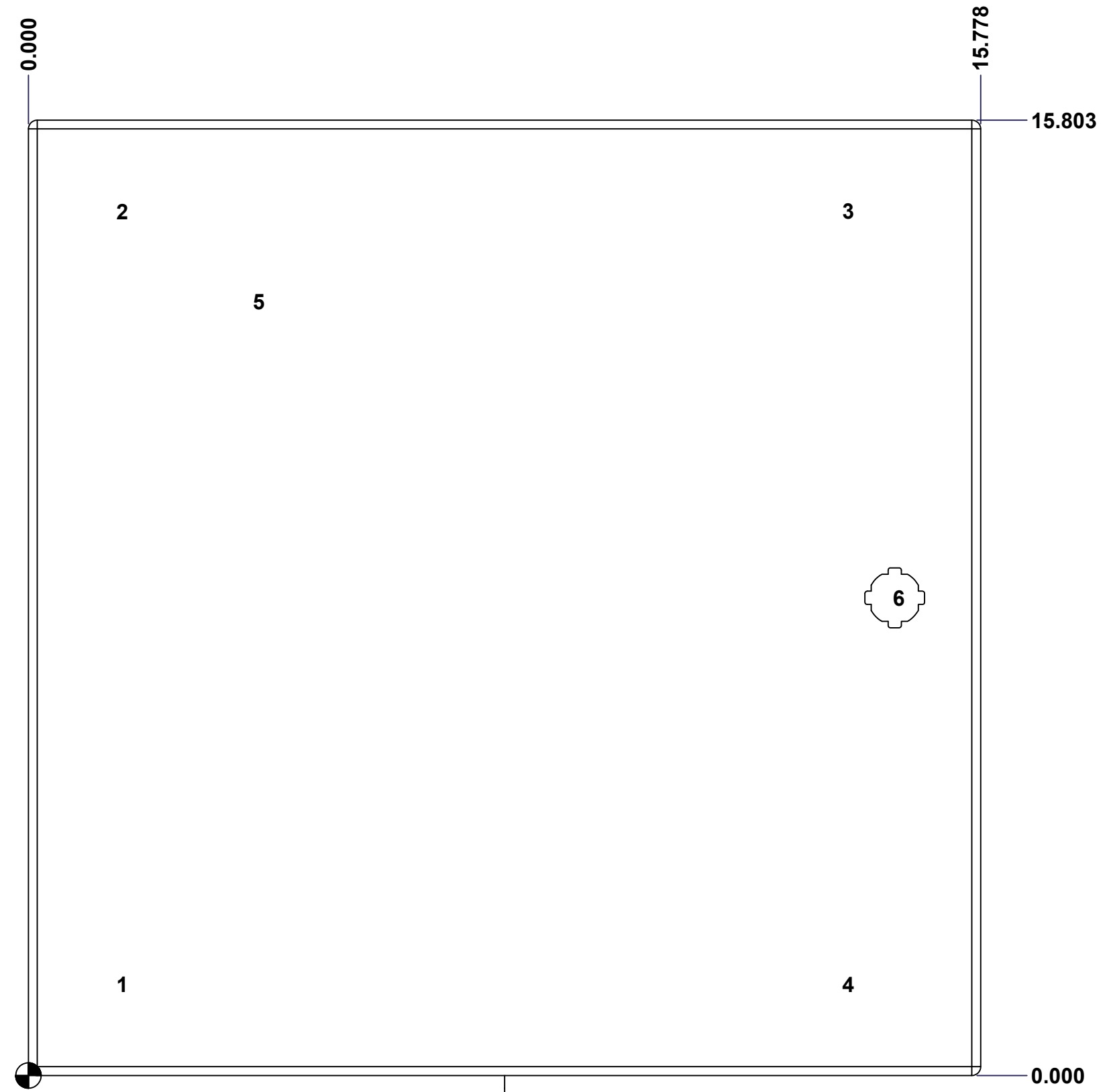

FRONT

	Description	Status	
	5412ESSBU 16" x 16" Cover	(NULL)	
	Part Number Numéro Pièce	Rev.	
	5412ESSBU161606C	0	2 3

This drawing is confidential and must not be reproduced or used without the consent of EXM

Ce dessin est confidentiel et ne doit pas être reproduit ou utilisé sans le consentement de EXM

No.	Revisions	Date	By/Par

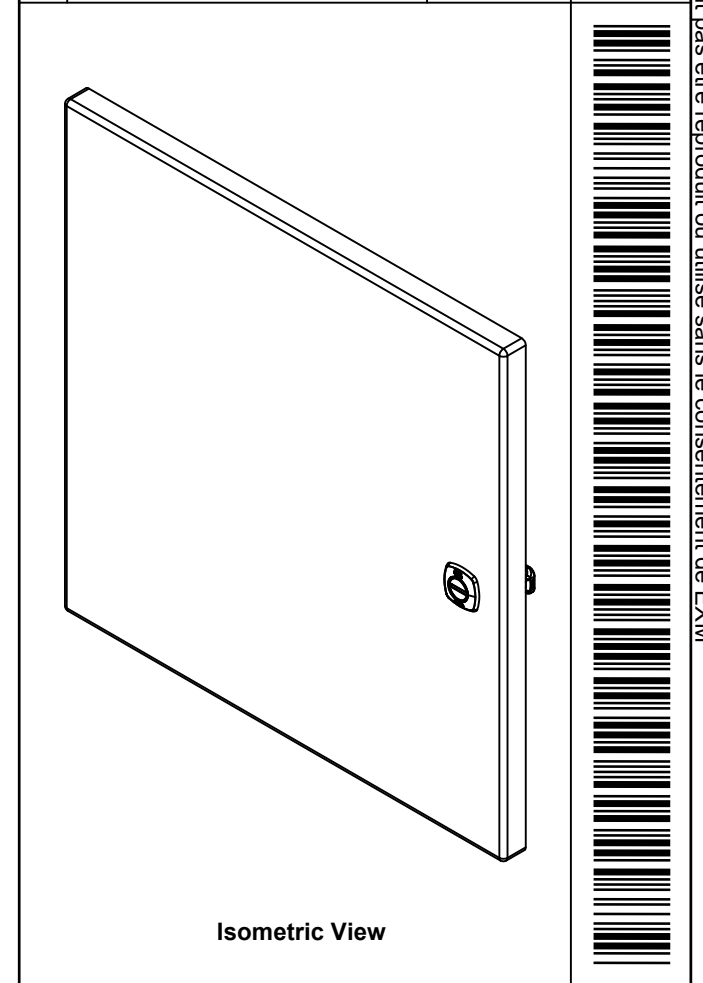

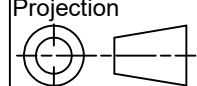
 Tél: (450) 979-4373 Fax: (450) 979-4626 www.exmweb.com		Flatness Aplatissement Max 3.0mm Projection 
Customer Client	Date	
Drawn By Dessiné Par	BoxCad: BoxCad	Date 08-May-14
Material Matière	16 Ga Stainless Steel 304 (1.4mm)	
Color Couleur	Unpainted	Finish Fini Brushed
Description		Detail Rev.
5412ESSBU 16" x 16" Cover		
Part Number Numéro Pièce	Rev.	3
5412ESSBU161606C	0	3

Qty	Part Name	Rev	Description
1	880 SCQ4-SLSS6	7	5412 ESS 1/4 Turn Lock
1	STK-S-00100	0	3.5" x 2" Silver Milar Flexcon Sticker
4	STK-Q-16070	1	Stud M6 x 18mm Stainless steel
1	5412ESSBU161606G	0	5412ESSBU 16" x 16" Cover Gasket Part
2	STK-A-33006	2	5412 ESSBU Hinge 180° (Body Part)
2	STK-Q-46020-16	5	5412 ES Vertical Door Stiffener 16"
1	5412ESSBU161606C-P	0	5412ESSBU 16" x 16" Cover Part
4	STK-Q-07220	1	M6 Nylon Insert Lock Nut
Parts List			

This drawing is confidential and must not be reproduced or used without the consent of EXM

Ce dessin est confidentiel et ne doit pas être reproduit ou utilisé sans le consentement de EXM



TOP

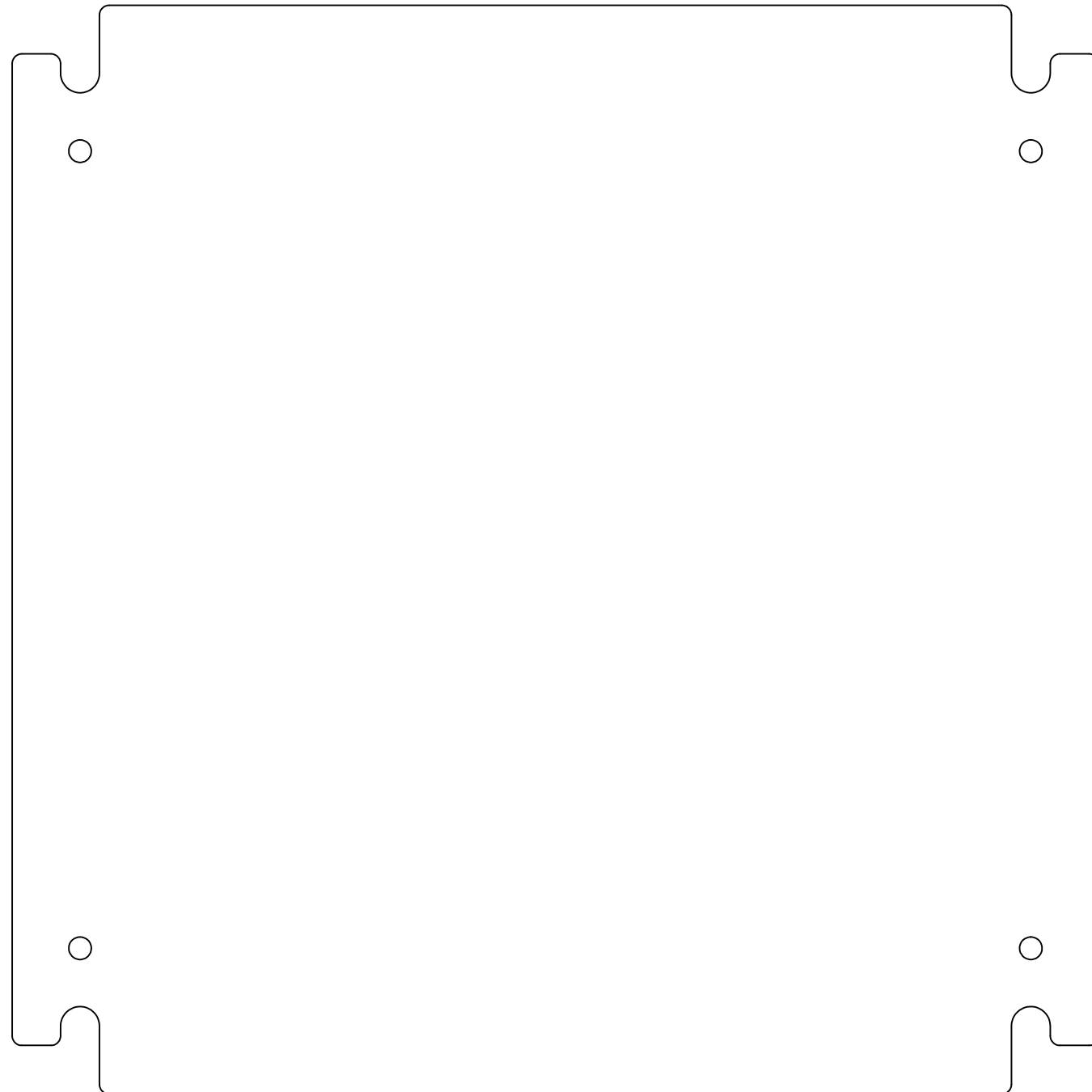

FRONT

14.000

0.000

RIGHT

No.	Revisions	Date	By/Par

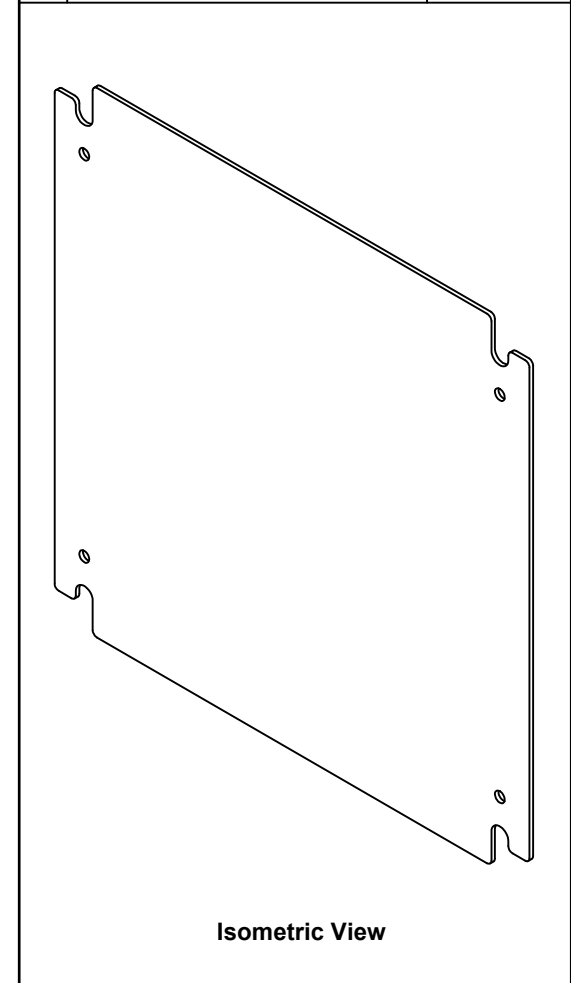

Isometric View

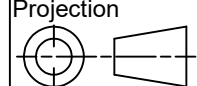

 Tél: (450) 979-4373 Fax: (450) 979-4626 www.exmweb.com		Flatness Aplatissement Max 3.0mm Projection 
Customer Client	Date	
Drawn By Dessiné Par: BoxCad	Date: 1/23/2007	
Material Matière	See Part List	
Color Couleur	See Part List	Finish Fini: See Part List
Description 881 SP - Inner Panel		Detail Rev.
Part Number Numéro Pièce: 881 SP1616G	Rev. 0	1/2

Qty	Part Number	Rev	Description	Material	Color	Finish
1	881 SP1616G-P	0	881 SP - Inner Panel Part	12 Ga Galvanized	Unpainted	Galvanized

Parts List

This drawing is confidential and must not be reproduced or used without the consent of EXM

Ce dessin est confidentiel et ne doit pas être reproduit ou utilisé sans le consentement de EXM

Table 1			FRONT VIEW
CUT-OUT	XDIM	YDIM	DESCRIPTION
1	0.875	1.875	GROUND HOLE (RND Ø0.290)
2	13.125	1.875	GROUND HOLE (RND Ø0.290)
3	0.875	12.125	GROUND HOLE (RND Ø0.290)
4	13.125	12.125	GROUND HOLE (RND Ø0.290)

All knockouts are actual size / Les disques défonçables sont grandeur réel

No.	Revisions	Date	By/Par

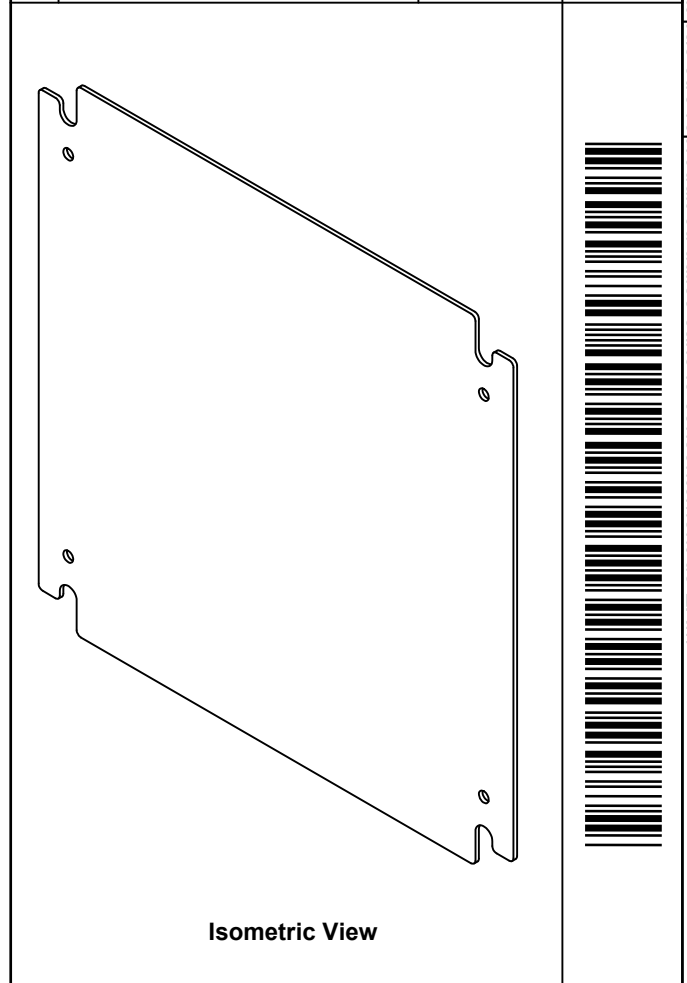
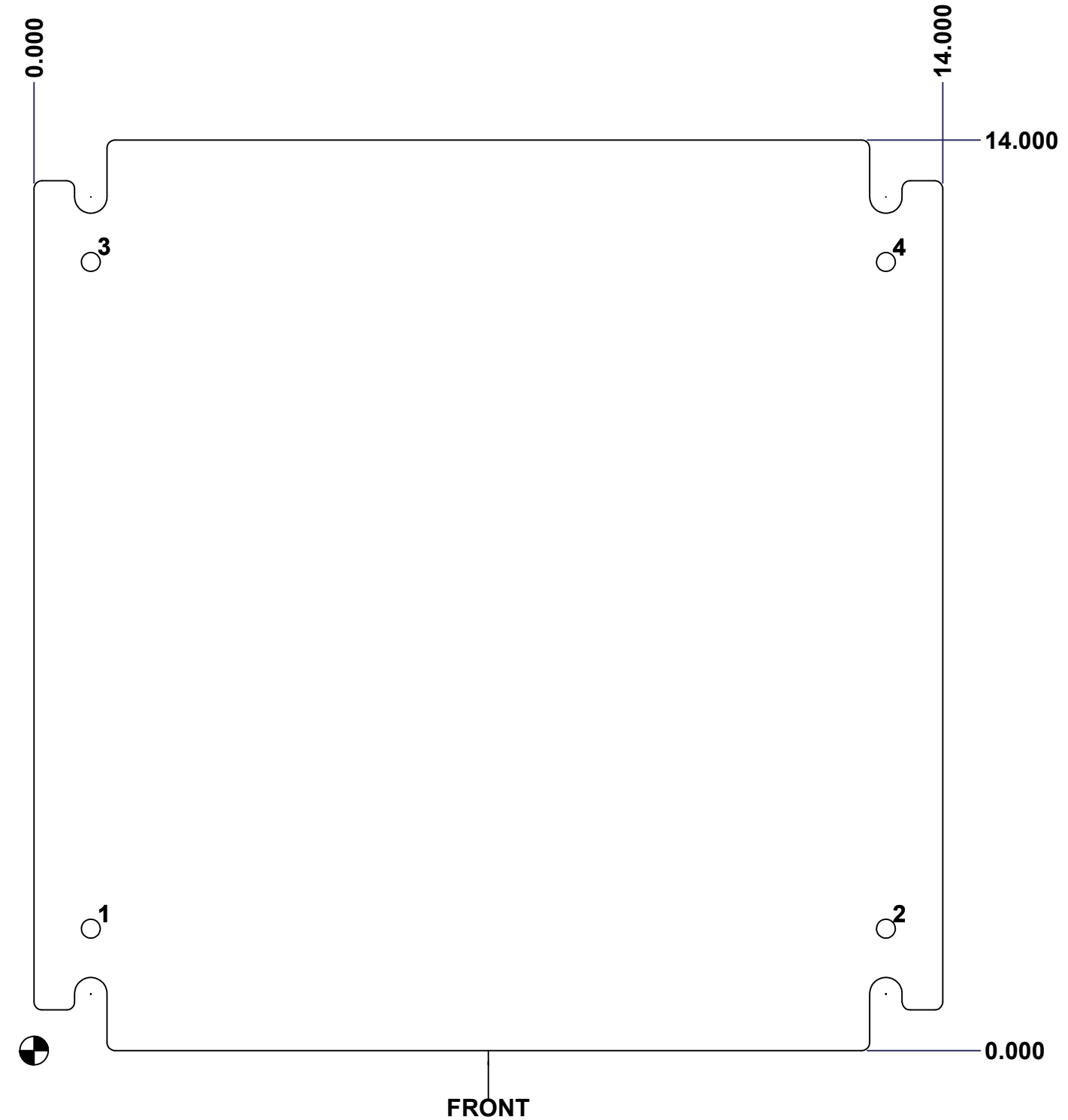

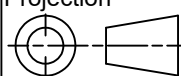
 Tél: (450) 979-4373 Fax: (450) 979-4626 www.exmweb.com	Flatness Aplatissement Max 3.0mm
	Projection 
Customer Client	Date
Drawn By Dessiné Par BoxCad	Date 1/23/2007
Material Matière See Part List	
Color Couleur See Part List	Finish Fini See Part List
Description 881 SP - Inner Panel	
Detail Rev.	
Part Number Numéro Pièce 881 SP1616G	Rev. 2 0