

This drawing is confidential and must not be reproduced or used without the consent of EXM

Ce dessin est confidentiel et ne doit pas être reproduit ou utilisé sans le consentement de EXM

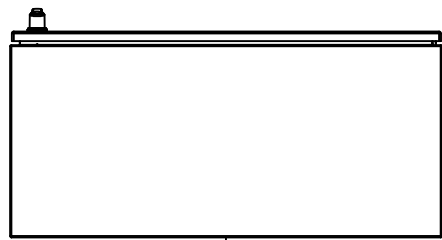

TOP

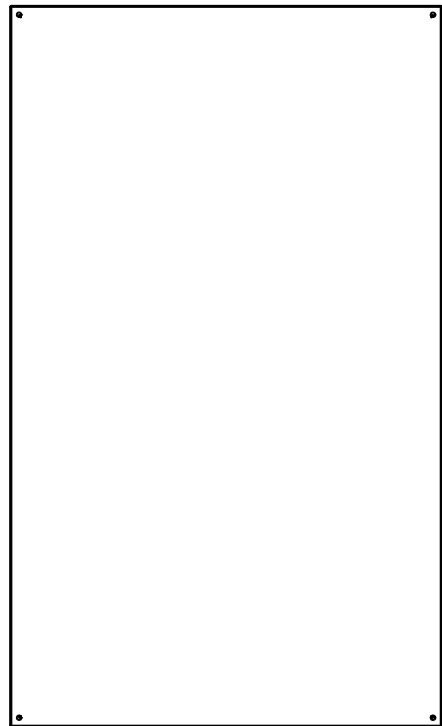

BACK

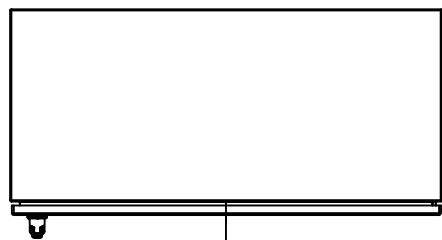

BOTTOM

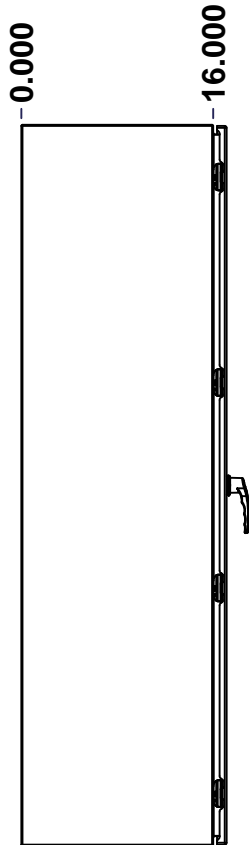

LEFT

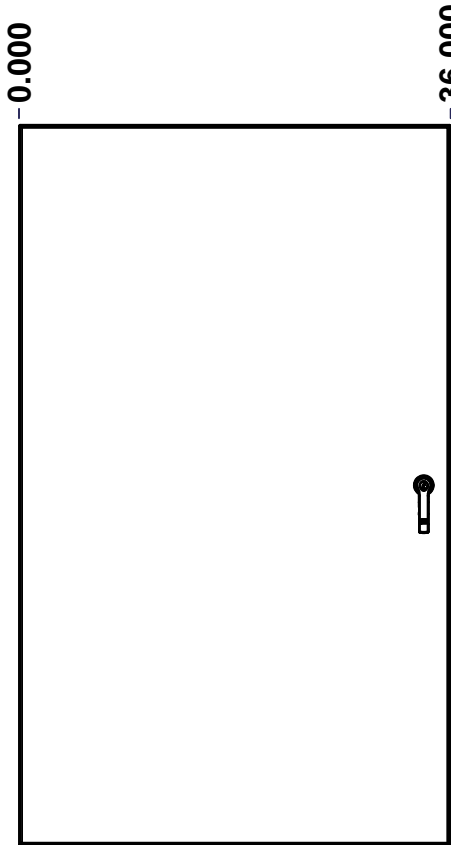

FRONT

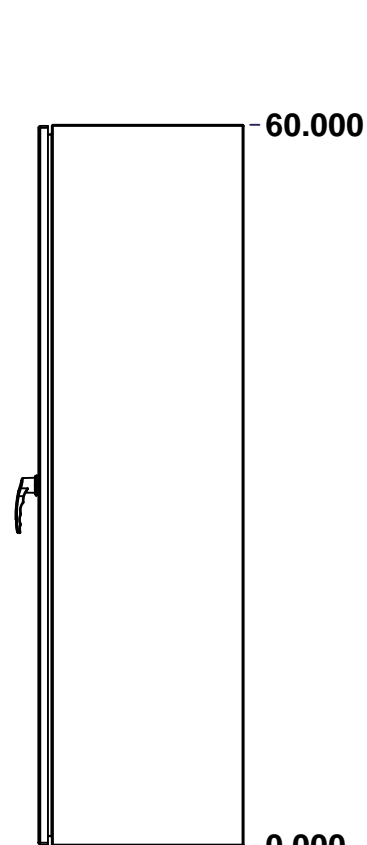

RIGHT

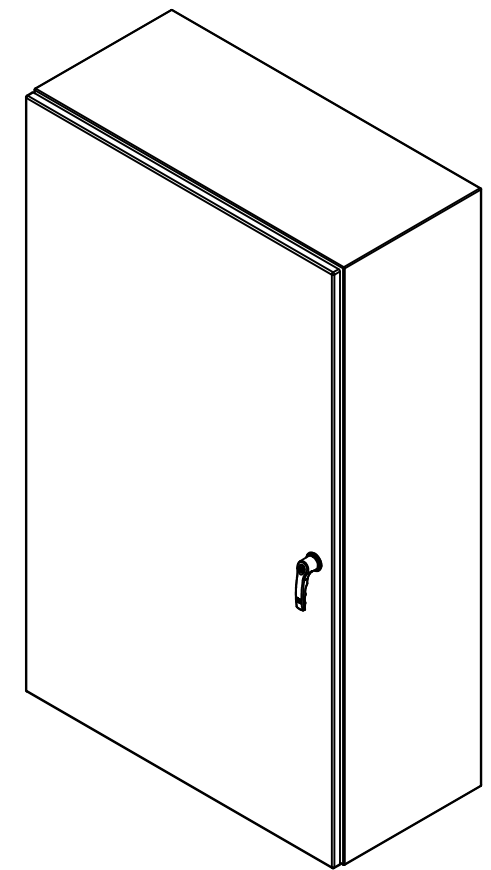

Isometric View

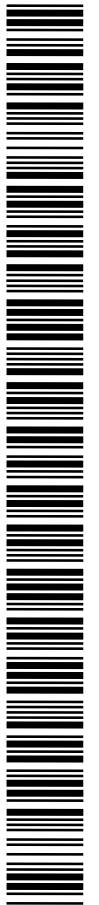

**GRAIN DIRECTION:
TOP/BOTTOM: HORIZONTAL
LEFT/RIGHT/BACK/FRONT: VERTICAL**

SEE BILL OF MATERIAL ON LAST PAGE

No.	Revisions	Date	By/Par

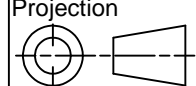
 Tél: (450) 979-4373 Fax: (450) 979-4626 www.exmweb.com		Flatness Aplatissement Max 3.0mm Projection 
Customer Client	Date	Date 13-May-14
Drawn By Dessiné Par	BoxCad: BoxCad	
Material Matière	14 Ga Stainless Steel 304 (1.7mm)	
Color Couleur	Unpainted	Finish Fini Brushed
Description	Detail Rev.	
5412ESSBU 60" x 36" x 16" Assembly		
Part Number Numéro Pièce	Rev.	
5412ESSBU603616	0	1 2

This drawing is confidential and must not be reproduced or used without the consent of EXM

Ce dessin est confidentiel et ne doit pas être reproduit ou utilisé sans le consentement de EXM

NOTE	
ITEM	DESCRIPTION
1	NEMA 4X Enclosure
2	C/W Standard ground studs on box and cover
3	C/W Standard door stiffener
4	C/W Standard inner panel (Included)
5	C/W Standard inner panel mounting studs

No.	Revisions	Date	By/Par

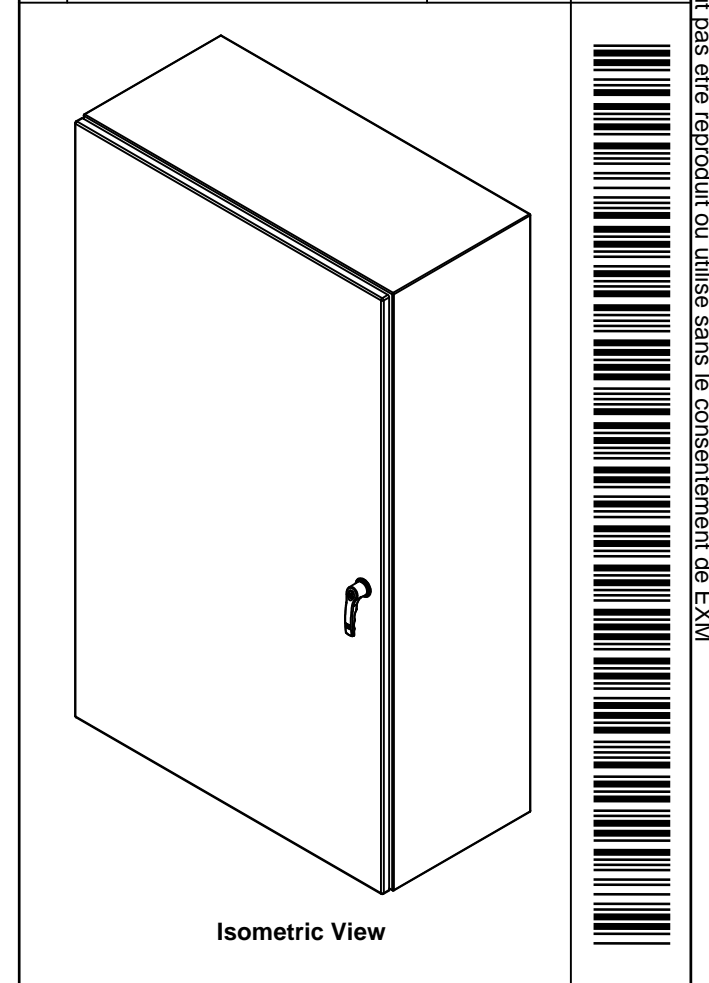

EXM
www.exmweb.com

Tél: (450) 979-4373
Fax: (450) 979-4626

Flatness
Aplatissement
Max 3.0mm
Projection

PACKING		
ITEM	QTY	DESCRIPTION
Cardboard sleeve	2	Top and Bottom
Cardboard strip	2	Between back of enclosure and inner panel
Plastic bag	1	To protect cover surface and inside gasket
Cardboard corner	4	To reinforced for the plastic strap tightening
Plastic strap - Black	2	To Squeeze the 2 cardboard sleeve together
Packaging label	3	White label with PN
Plastic strap- Green	2	To secure the enclosure to the wood pallet
Wood Pallet	1	2" deeper and 3" larger than enclosure size

1	880 PP	6	Self Adhesive Print Pocket
1	STK-K-01800	5	5412 ES Accessory Kit
1	881 SP6036G	0	881 SP - Inner Panel
1	5412ESSBU603616C	0	5412ESSBU 60" x 36" Cover
8	STK-Q-07310	2	Flange Lock Nut M8
8	STK-Q-07610	8	M8 Plastic Spacer 22.2mm
1	5412ESSBU603616B	0	5412ESSBU 60" x 36" x 16" Body
8	STK-Q-04051-07	8	M6 x 7mm Stainless Steel Hexagon Socket Head Machine Screw with Nyseal
Qty	Part Number	Rev	Description
Parts List			

Customer Client

Drawn By
Dessiné Par BoxCad: BoxCad

Material
Matière 14 Ga Stainless Steel 304 (1.7mm)

Color
Couleur Unpainted

Finish
Fini Brushed

Description
5412ESSBU 60" x 36" x 16" Assembly

Part Number
Numéro Pièce **5412ESSBU603616**

Date 13-May-14

Detail Rev.

Rev.	2
0	2

This drawing is confidential and must not be reproduced or used without the consent of EXM

Ce dessin est confidentiel et ne doit pas être reproduit ou utilisé sans le consentement de EXM

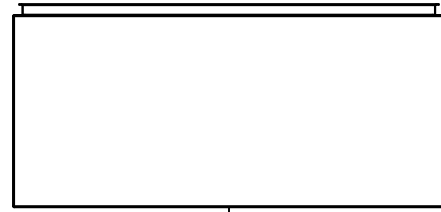

TOP



BACK

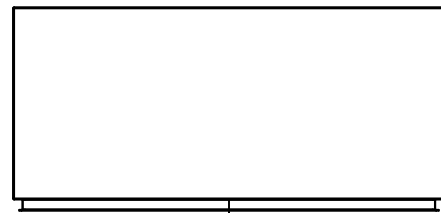

BOTTOM

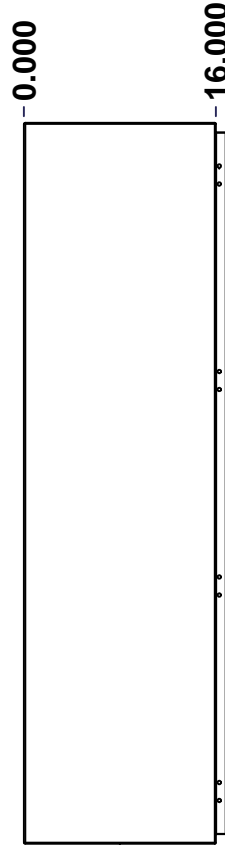

LEFT

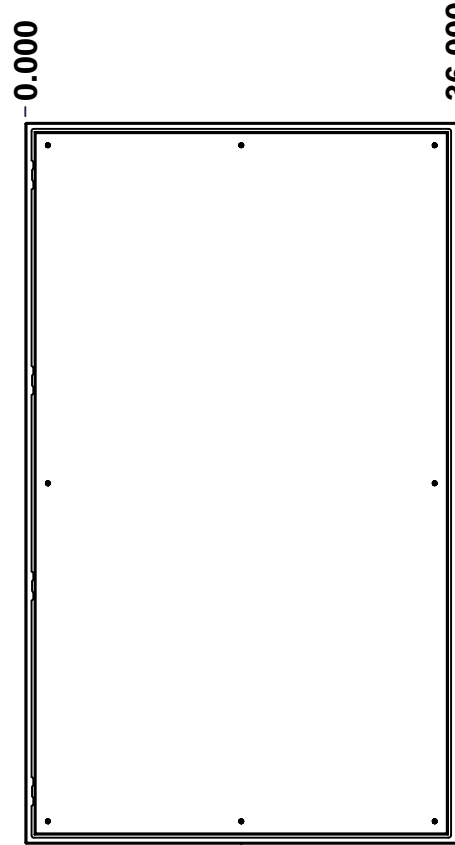

FRONT

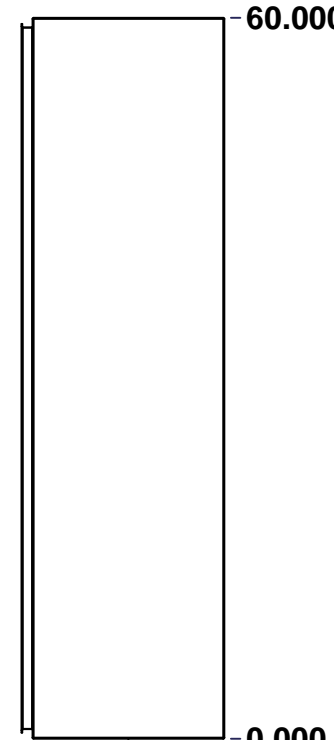

RIGHT

No.	Revisions	Date	By/Par

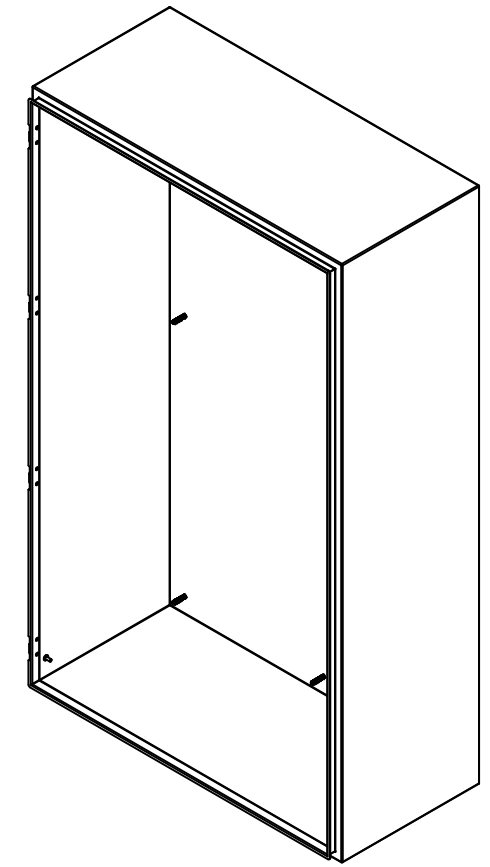

Isometric View



Tél: (450) 979-4373
 Fax: (450) 979-4626
www.exmweb.com

Flatness
Aplatissement
Max 3.0mm
Projection

Customer Client	Date
Drawn By / Dessiné Par: BoxCad: BoxCad	Date: 13-May-14
Material / Matière: 14 Ga Stainless Steel 304 (1.7mm)	
Color / Couleur: Unpainted	Finish / Fini: Brushed
Description: 5412ESSBU 60" x 36" x 16" Body	
Part Number / Numéro Pièce: 5412ESSBU603616B	Detail Rev. / Rev. 1/7

SEE BILL OF MATERIAL ON LAST PAGE

This drawing is confidential and must not be reproduced or used without the consent of EXM

Ce dessin est confidentiel et ne doit pas être reproduit ou utilisé sans le consentement de EXM

STANDARD FEATURES ARE NOT LISTED IN THIS HOLE TABLE			
HOLE TABLE - LEFT VIEW (CUSTOM FEATURE ONLY)			
CUT-OUT	XDIM	YDIM	DESCRIPTION
1	14.500	2.000	GND STUD M6 x 16mm (Inside)

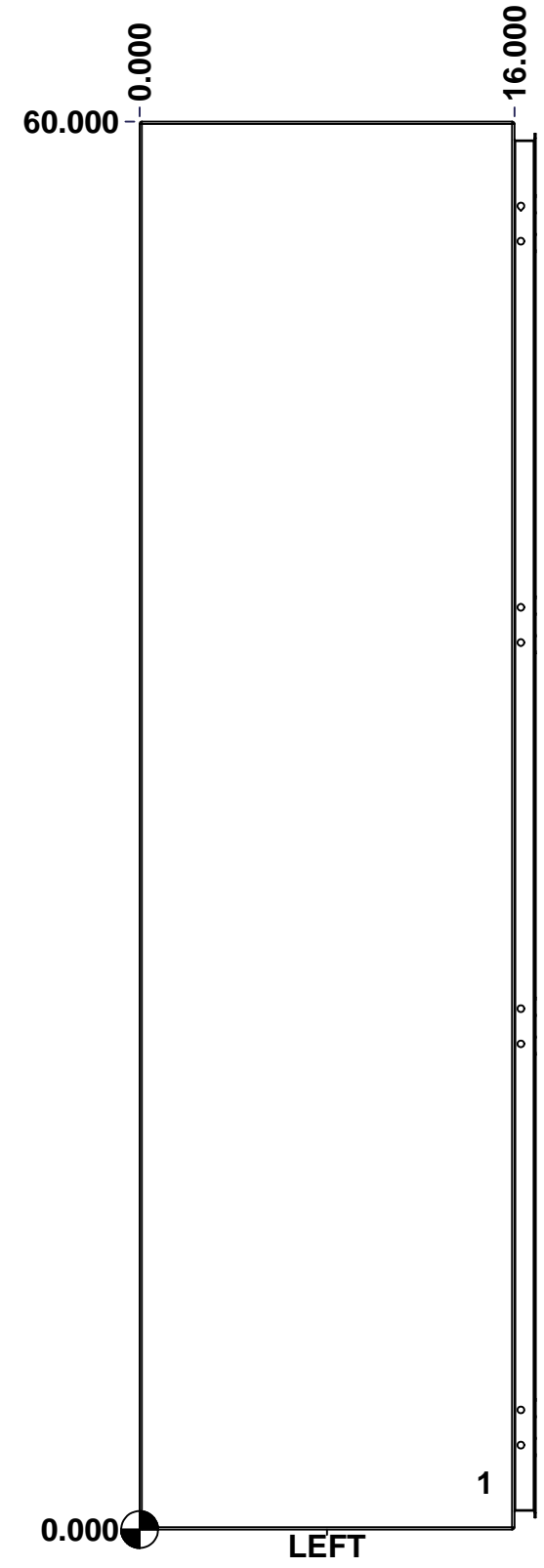

	Description	Status	
	5412ESSBU 60" x 36" x 16" Body		
	Part Number Numéro Pièce	Rev.	5 7
	5412ESSBU603616B	0	

This drawing is confidential and must not be reproduced or used without the consent of EXM

Ce dessin est confidentiel et ne doit pas être reproduit ou utilisé sans le consentement de EXM

STANDARD FEATURES ARE NOT LISTED IN THIS HOLE TABLE

HOLE TABLE - BACK VIEW (CUSTOM FEATURE ONLY)

CUT-OUT	XDIM	YDIM	DESCRIPTION
1	1.875	1.875	IP STUD M8 x 35mm (Inside)
2	1.875	58.125	IP STUD M8 x 35mm (Inside)
3	34.125	58.125	IP STUD M8 x 35mm (Inside)
4	34.125	1.875	IP STUD M8 x 35mm (Inside)
5	1.875	30.000	IP STUD M8 x 35mm (Inside)
6	34.125	30.000	IP STUD M8 x 35mm (Inside)
7	18.000	1.875	IP STUD M8 x 35mm (Inside)
8	18.000	58.125	IP STUD M8 x 35mm (Inside)

9	35.250	0.750	RND Ø0.390
10	35.250	59.250	RND Ø0.390
11	0.750	59.250	RND Ø0.390
12	0.750	0.750	RND Ø0.390

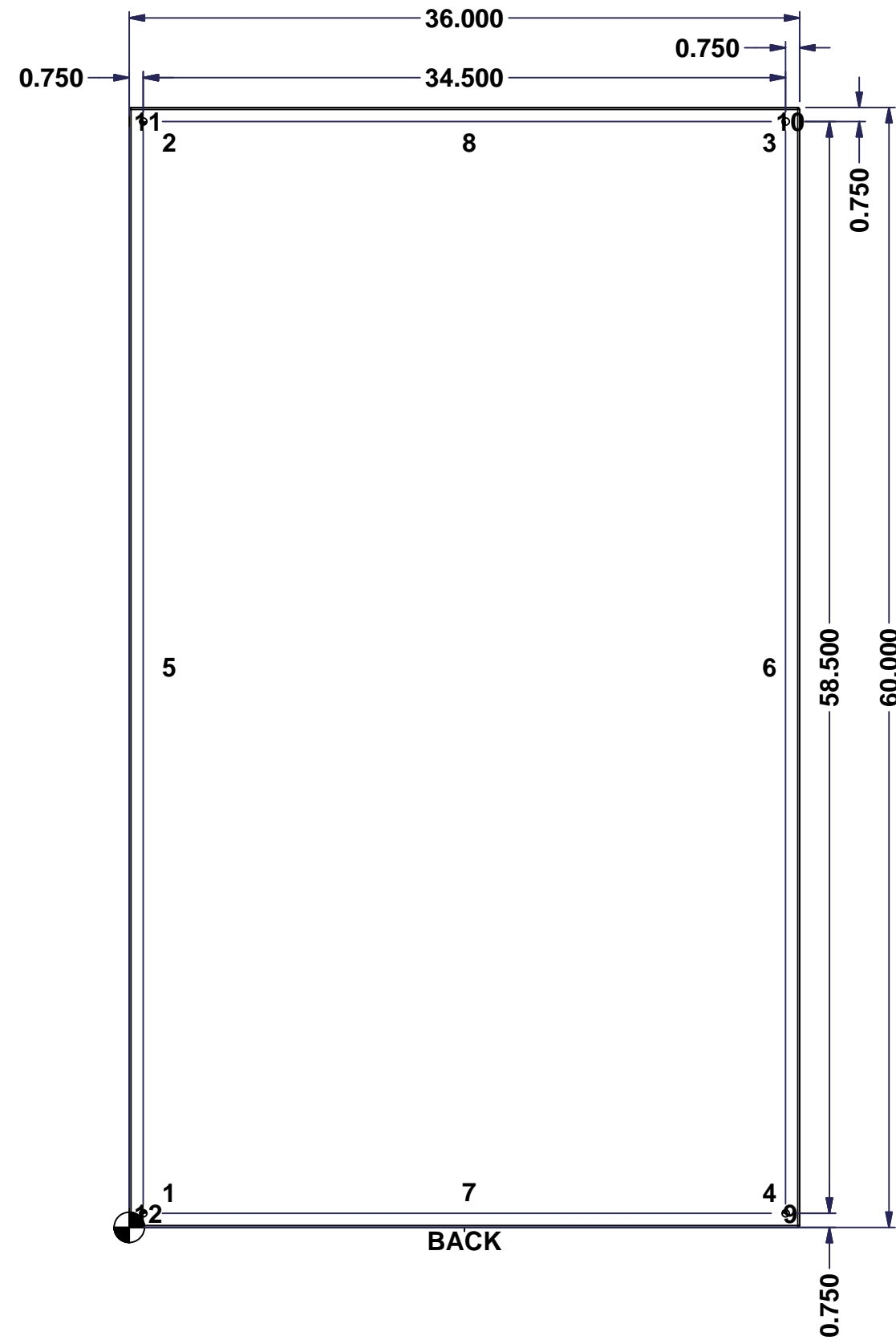

	Description	Status
	5412ESSBU 60" x 36" x 16" Body	
	Part Number Numéro Pièce	Rev.
	5412ESSBU603616B	0
		6
		7

This drawing is confidential and must not be reproduced or used without the consent of EXM

Ce dessin est confidentiel et ne doit pas être reproduit ou utilisé sans le consentement de EXM

No.	Revisions	Date	By/Par

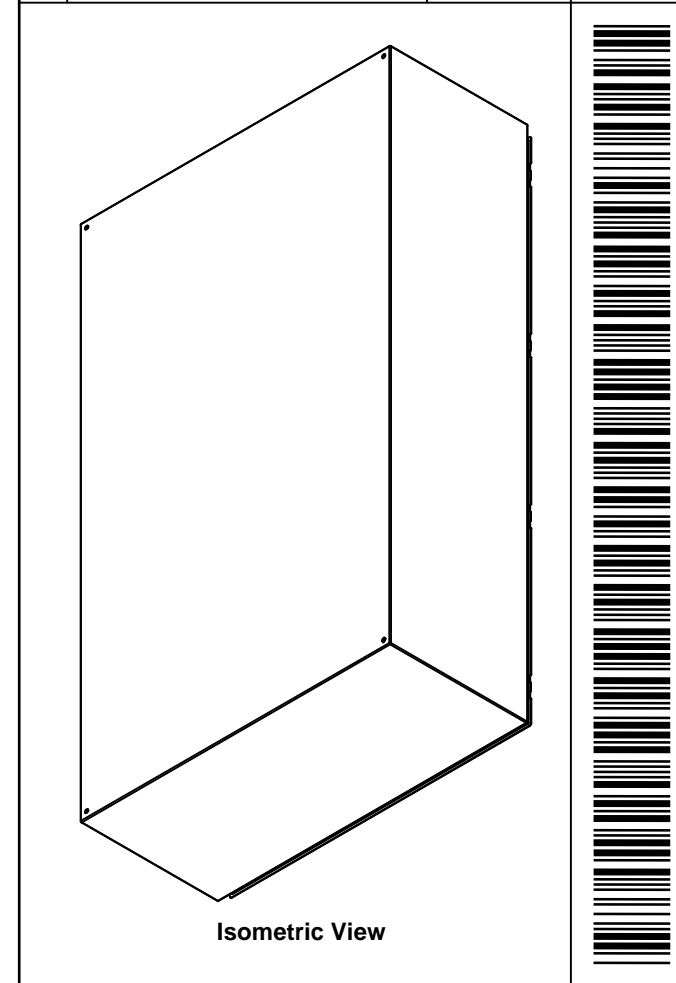

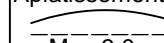
 Tél: (450) 979-4373 Fax: (450) 979-4626 www.exmweb.com		Flatness Aplatissement  Max 3.0mm Projection 
Customer Client	Date	
Drawn By Dessiné Par	BoxCad: BoxCad	Date 13-May-14
Material Matière	14 Ga Stainless Steel 304 (1.7mm)	
Color Couleur	Unpainted	Finish Fini Brushed
Description		Detail Rev.
5412ESSBU 60" x 36" x 16" Body		
Part Number Numéro Pièce	Rev.	7
5412ESSBU603616B	0	7

Qty	Part Number	Rev	Description
1	STK-Q-16085	0	Ground Stud M6 x 16mm Stainless Steel
8	STK-Q-16020	1	Stud M8 x 35mm Stainless Steel
1	5412ESSBU603616B-P	0	5412ESSBU 60" x 36" x 16" Body Part
Parts List			

This drawing is confidential and must not be reproduced or used without the consent of EXM

Ce dessin est confidentiel et ne doit pas être reproduit ou utilisé sans le consentement de EXM

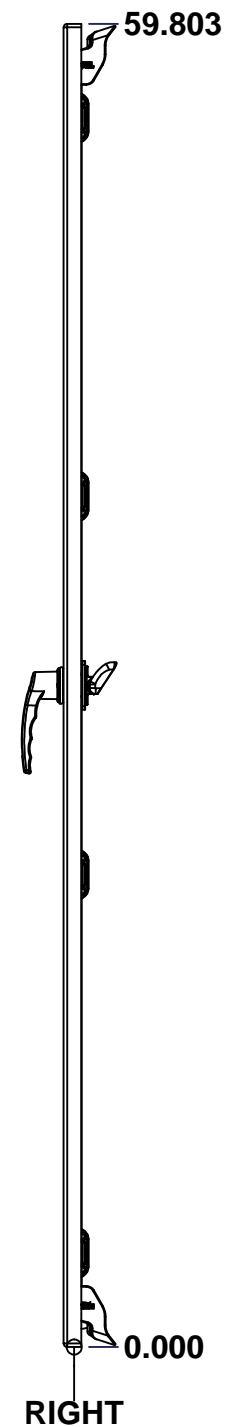
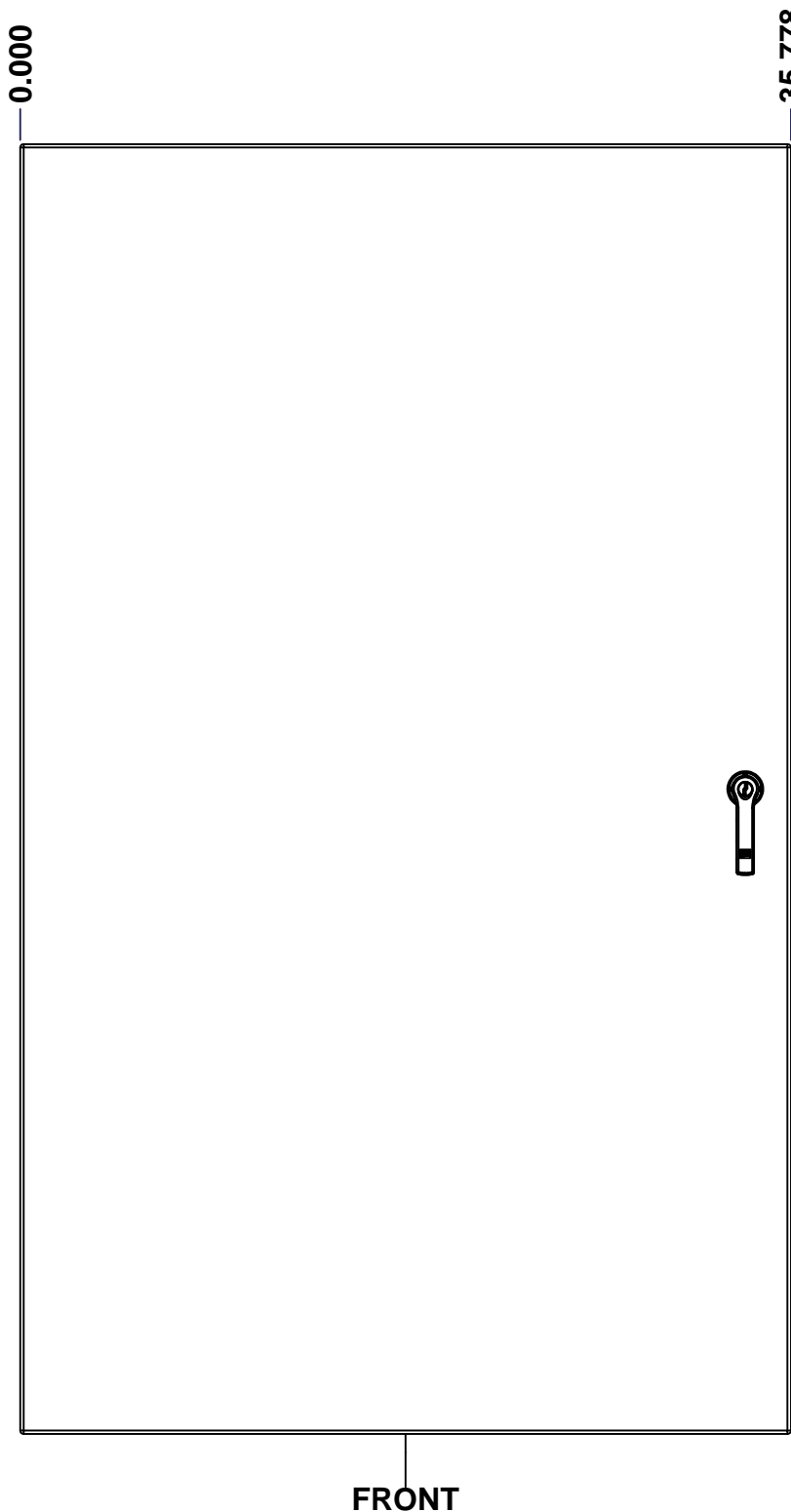
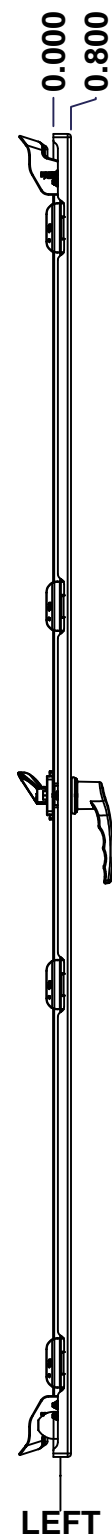
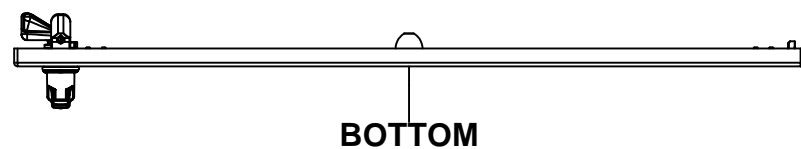
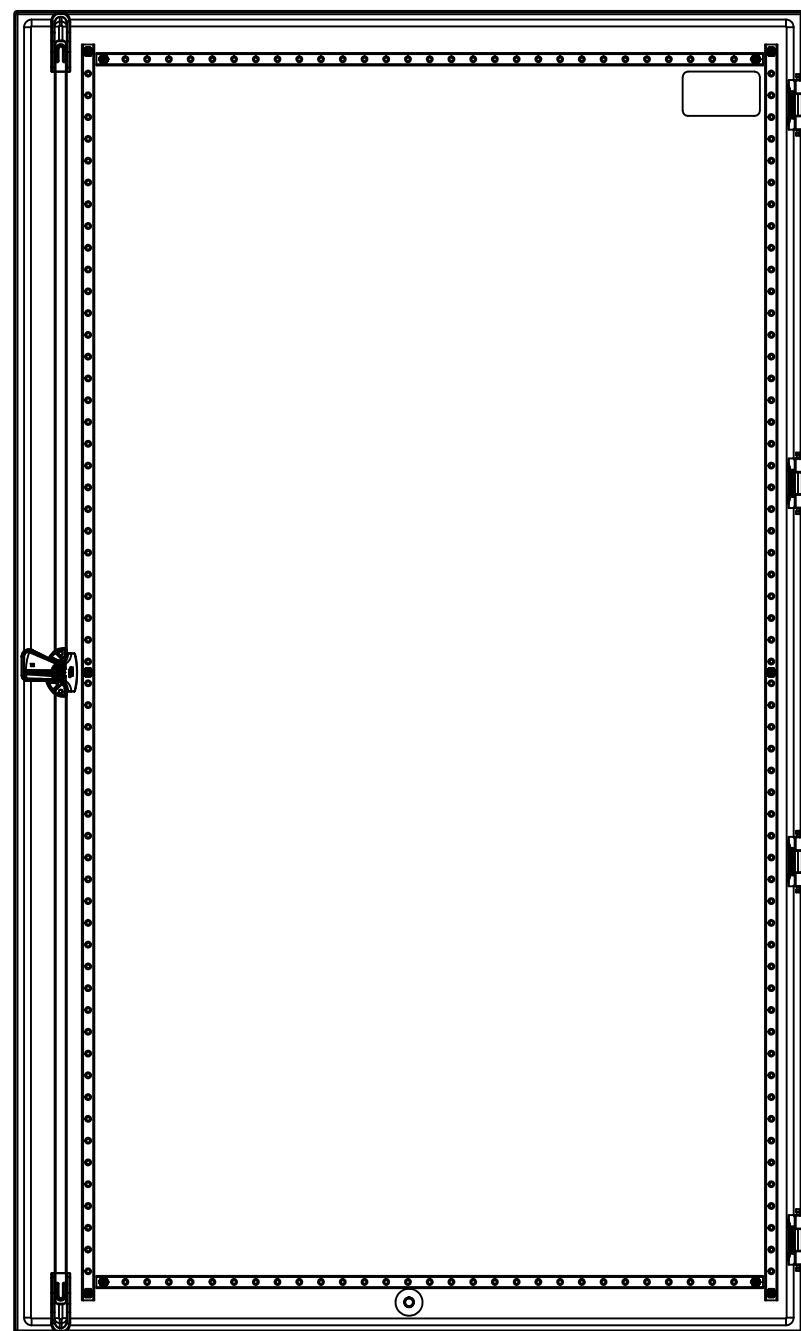
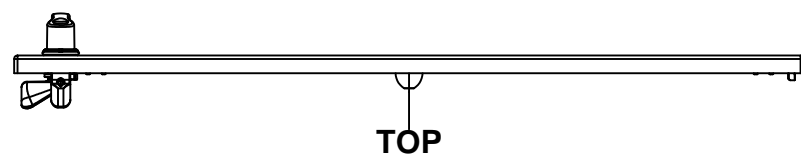

No.	Revisions	Date	By/Par

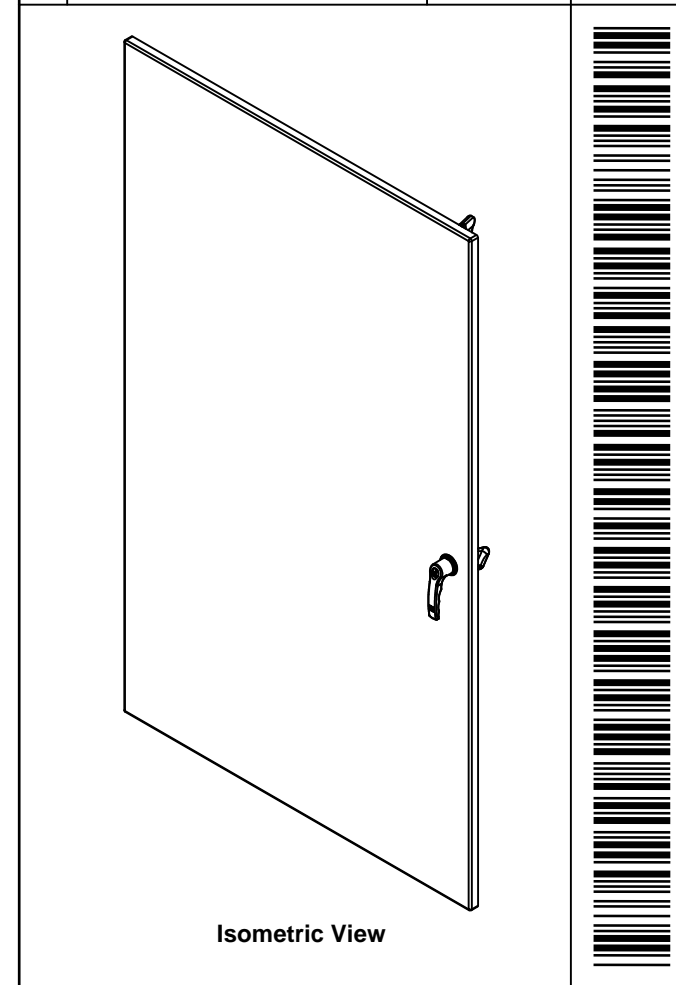

Tél: (450) 979-4373 Fax: (450) 979-4626 www.exmweb.com		Flatness Aplatissement Max 3.0mm Projection
Customer Client	Date	
Drawn By Dessiné Par	BoxCad: BoxCad	Date 13-May-14
Material Matière	14 Ga Stainless Steel 304 (1.7mm)	
Color Couleur	Unpainted	Finish Fini Brushed
Description	Detail Rev.	
5412ESSBU 60" x 36" Cover		
Part Number Numéro Pièce	Rev.	1
5412ESSBU603616C	0	3

SEE BILL OF MATERIAL ON LAST PAGE

This drawing is confidential and must not be reproduced or used without the consent of EXM

Ce dessin est confidentiel et ne doit pas être reproduit ou utilisé sans le consentement de EXM

STANDARD FEATURES ARE NOT LISTED IN THIS HOLE TABLE

HOLE TABLE - FRONT VIEW (CUSTOM FEATURE ONLY)

CUT-OUT	XDIM	YDIM	DESCRIPTION
1	1.486	1.850	STUD M6 x 18mm (Inside)
2	1.486	57.953	STUD M6 x 18mm (Inside)
3	32.423	57.953	STUD M6 x 18mm (Inside)
4	32.423	1.850	STUD M6 x 18mm (Inside)
5	1.486	29.902	STUD M6 x 18mm (Inside)
6	32.423	29.902	STUD M6 x 18mm (Inside)
7	2.191	2.350	STUD M6 x 18mm (Inside)
8	2.191	57.619	STUD M6 x 18mm (Inside)
9	31.718	57.619	STUD M6 x 18mm (Inside)
10	31.718	2.350	STUD M6 x 18mm (Inside)
11	33.663	54.896	CLOSING BAR STUD (Inside)
12	33.663	4.907	CLOSING BAR STUD (Inside)
13	17.959	1.435	STUD M6 x 18mm (Inside)

14	3.750	56.053	LABEL_EXM (Inside)
15	33.663	29.902	HANDLE 885 ESL2A-LSS @ 0.0°

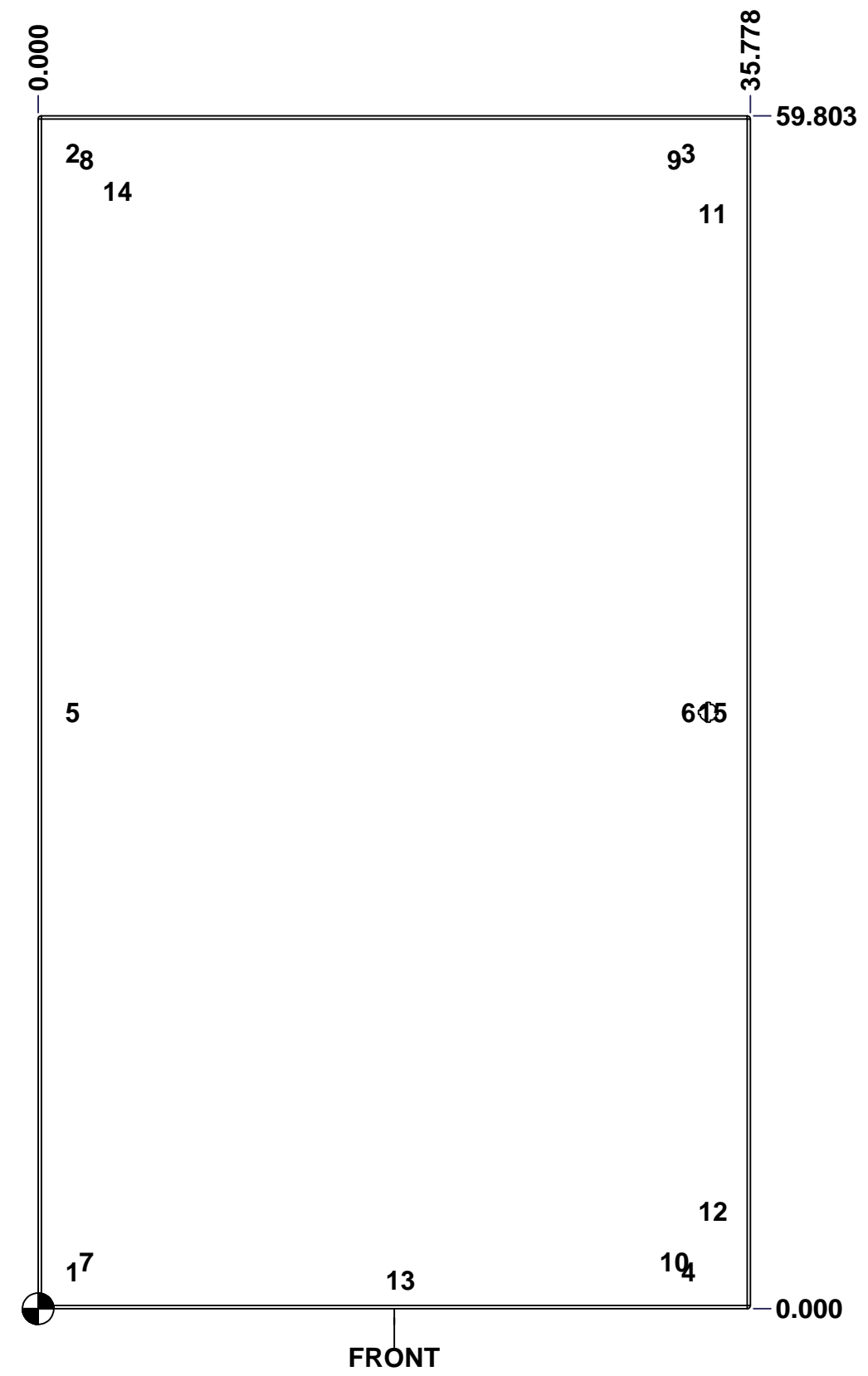

	Description	Status
	5412ESSBU 60" x 36" Cover	(NULL)
	Part Number Numéro Pièce	Rev.
	5412ESSBU603616C	0
		2
		3

This drawing is confidential and must not be reproduced or used without the consent of EXM

Ce dessin est confidentiel et ne doit pas être reproduit ou utilisé sans le consentement de EXM

No.	Revisions	Date	By/Par

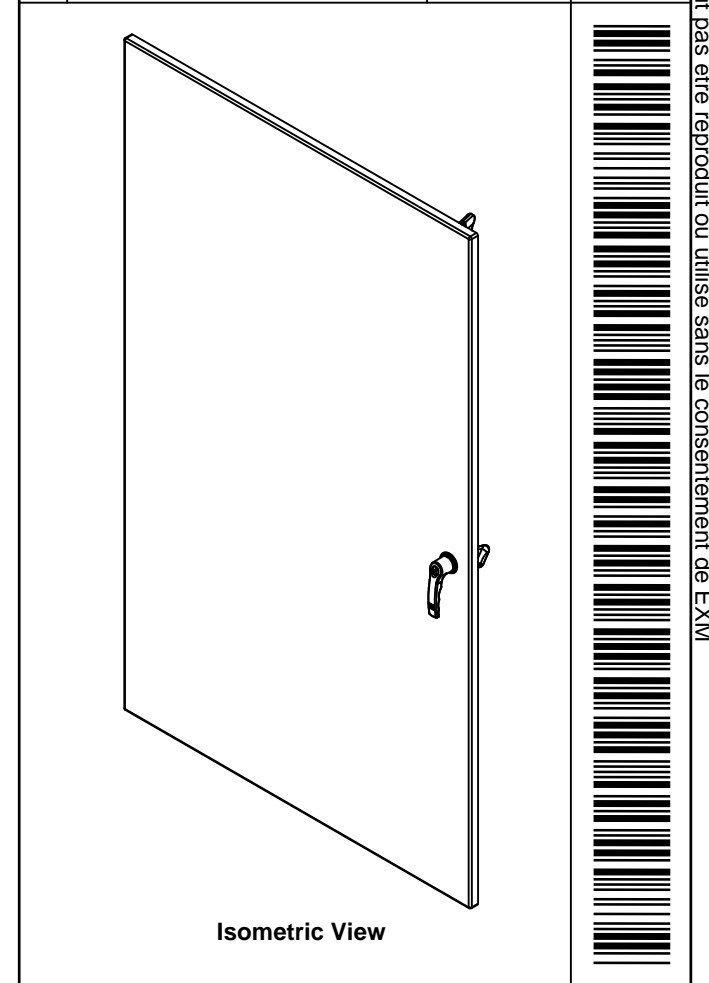

2	STK-Q-90042	4	5412 ES - Cabinet Closing Bar End (Small)
2	STK-Q-45655-60	0	5412 ES - Closing Bar
1	STK-Q-50536	11	5412 ES - Handle Cam Clockwise (Grip 32mm)
1	885 ESL2A-LSS	3	5412 ESS Key Lock L-Handle (3 Pts)
1	STK-S-00100	0	3.5" x 2" Silver Milar Flexcon Sticker
1	STK-Q-46515	3	5412 ES Door Support with Brass Insert
11	STK-Q-16070	1	Stud M6 x 18mm Stainless steel
1	5412ESSBU603616G	0	5412ESSBU 60" x 36" Cover Gasket Part
4	STK-A-33006	2	5412 ESSBU Hinge 180° (Body Part)
2	STK-Q-46025-36-3	0.1	5412 ES Horizontal Door Stiffener 36" (3 Pts)
2	STK-Q-46020-60	5	5412 ES Vertical Door Stiffener 60"
2	STK-Q-16407	2	Guide Stud - Small (No Paint Cap Required)
1	5412ESSBU603616C-P	0	5412ESSBU 60" x 36" Cover Part
10	STK-Q-07220	1	M6 Nylon Insert Lock Nut
Qty	Part Name	Rev	Description
Parts List			

 Tél: (450) 979-4373 Fax: (450) 979-4626 www.exmweb.com		Flatness Aplatissement
		Max 3.0mm
Customer Client		Date
Drawn By Dessiné Par BoxCad: BoxCad		Date 13-May-14
Material Matière 14 Ga Stainless Steel 304 (1.7mm)		
Color Couleur Unpainted	Finish Fini Brushed	
Description 5412ESSBU 60" x 36" Cover		Detail Rev.
Part Number Numéro Pièce 5412ESSBU603616C		Rev. 3
		0
		3

This drawing is confidential and must not be reproduced or used without the consent of EXM

Tolerance ±1/32" unless otherwise specified

C:\Vault Workspace\Inventor Dwg\Inv-8\881SP\881SP6036G.idw

Tolérance ±1/32" sauf spécification contraire

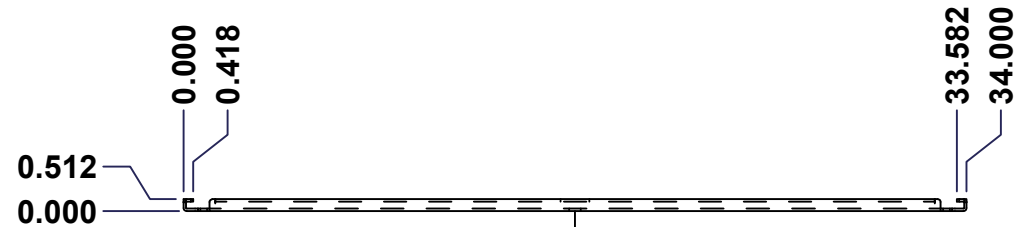

TOP

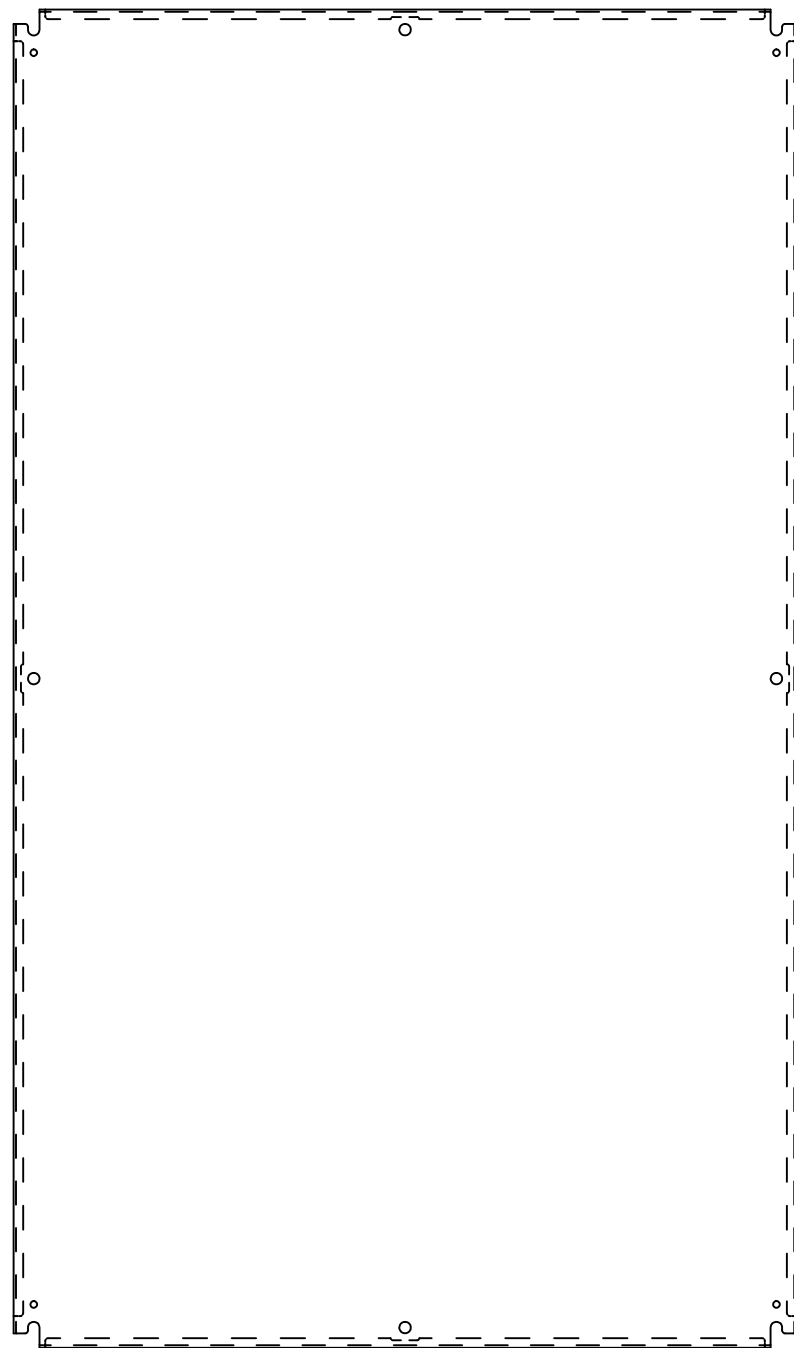

FRONT

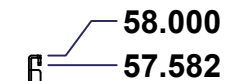

RIGHT

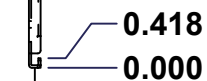

No.	Revisions	Date	By/Par

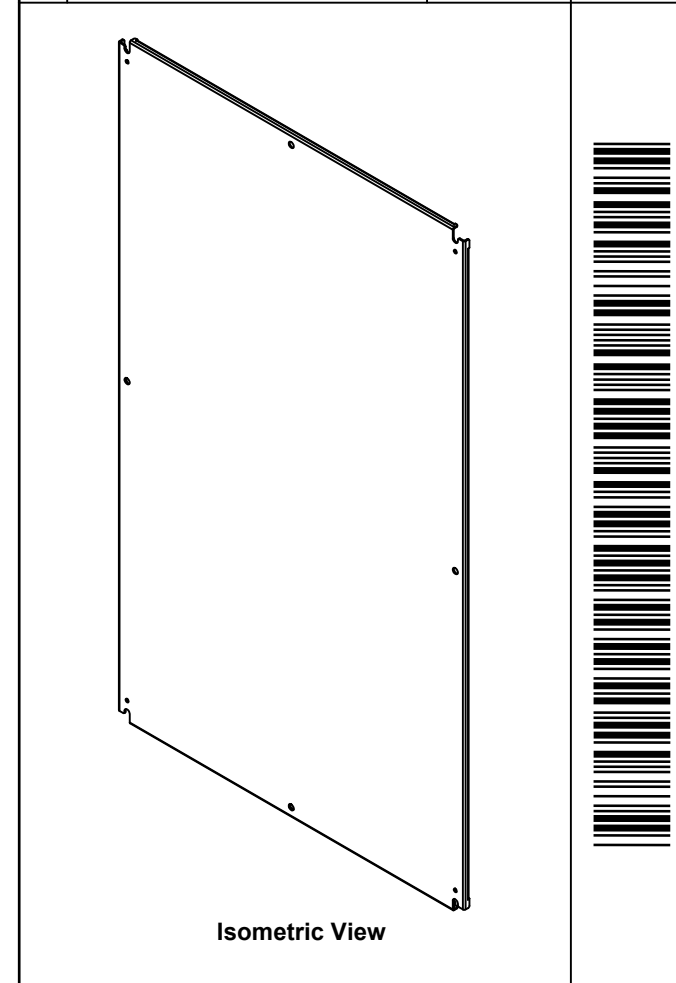

Ce dessin est confidentiel et ne doit pas être reproduit ou utilisé sans le consentement de EXM

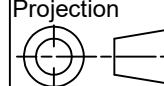
 Tél: (450) 979-4373 Fax: (450) 979-4626 www.exmweb.com		Flatness Aplatissement Max 3.0mm Projection 
Customer Client	Date	
Drawn By Dessiné Par	BoxCad	Date 1/23/2007
Material Matière	See Part List	
Color Couleur	See Part List	Finish Fini See Part List
Description		Detail Rev.
881 SP - Inner Panel		
Part Number Numéro Pièce	881 SP6036G	Rev. 1 0

Qty	Part Number	Rev	Description	Material	Color	Finish
1	881 SP6036G-P	0	881 SP - Inner Panel Part	12 Ga Galvanized	Unpainted	Galvanized

Parts List

This drawing is confidential and must not be reproduced or used without the consent of EXM

Ce dessin est confidentiel et ne doit pas être reproduit ou utilisé sans le consentement de EXM

Table 1			FRONT VIEW
CUT-OUT	XDIM	YDIM	DESCRIPTION
1	17.000	0.875	MTG STUD HOLE (RND Ø0.500)
2	0.875	29.000	MTG STUD HOLE (RND Ø0.500)
3	33.125	29.000	MTG STUD HOLE (RND Ø0.500)
4	17.000	57.125	MTG STUD HOLE (RND Ø0.500)
5	0.875	1.875	GROUND HOLE (RND Ø0.290)
6	33.125	1.875	GROUND HOLE (RND Ø0.290)
7	0.875	56.125	GROUND HOLE (RND Ø0.290)
8	33.125	56.125	GROUND HOLE (RND Ø0.290)

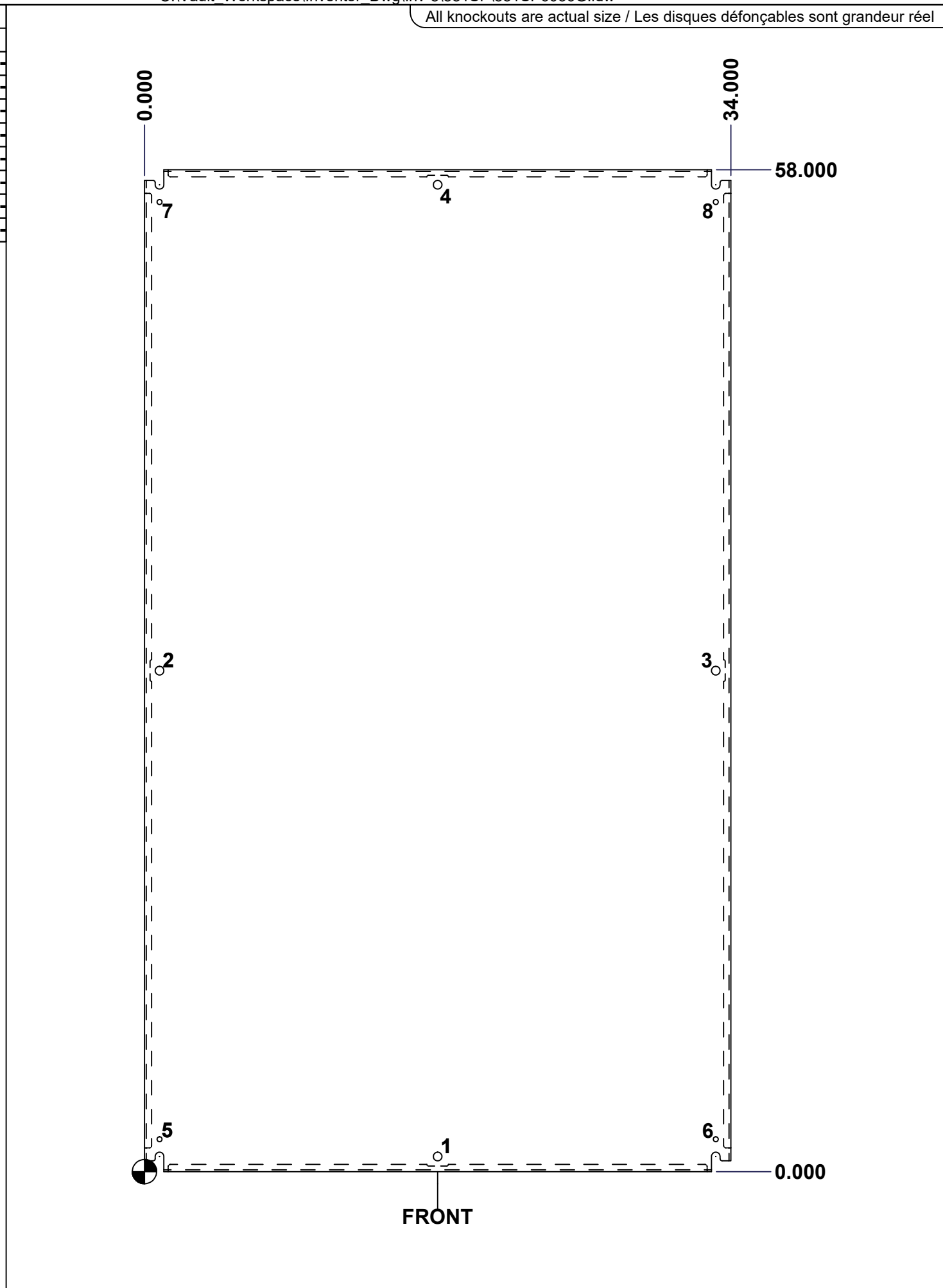

No.	Revisions	Date	By/Par

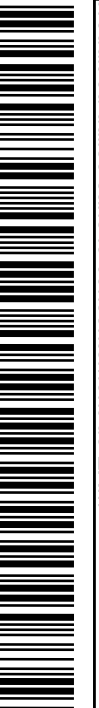
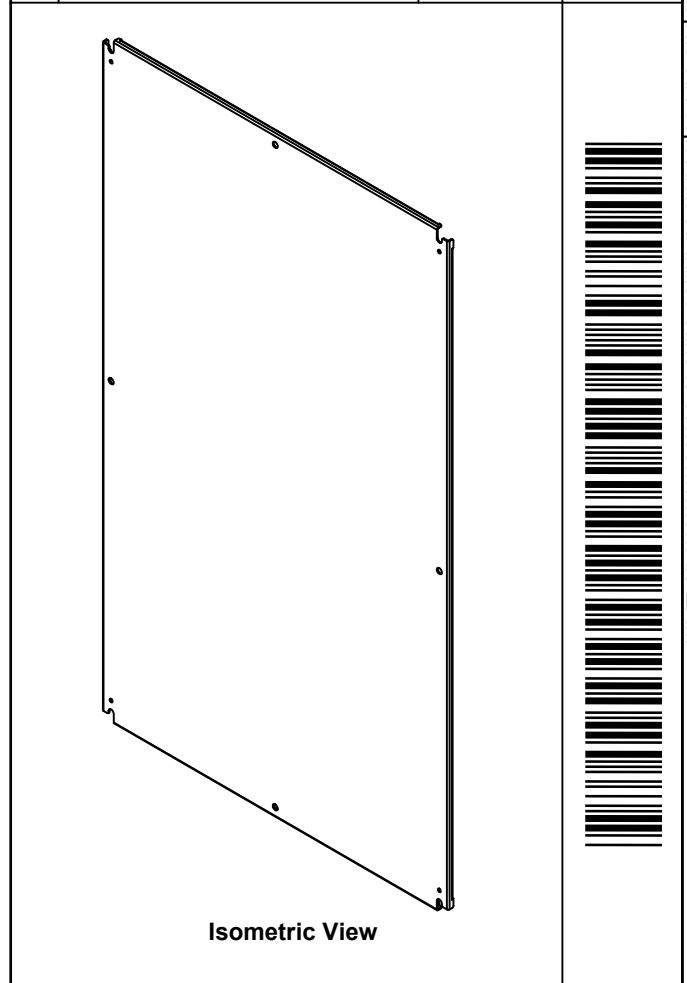

 Tél: (450) 979-4373 Fax: (450) 979-4626 www.exmweb.com		Flatness Aplatissement
		Max 3.0mm
Customer Client		Date
Drawn By Dessiné Par BoxCad		Date 1/23/2007
Material Matière See Part List		
Color Couleur See Part List	Finish Fini See Part List	
Description 881 SP - Inner Panel		Detail Rev.
Part Number Numéro Pièce 881 SP6036G		Rev. 2 0