

This drawing is confidential and must not be reproduced or used without the consent of EXM

Ce dessin est confidentiel et ne doit pas être reproduit ou utilisé sans le consentement de EXM

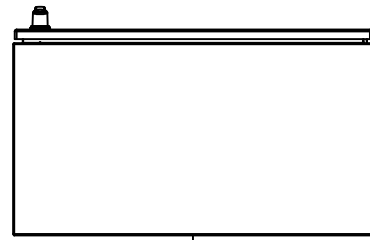

TOP



BACK

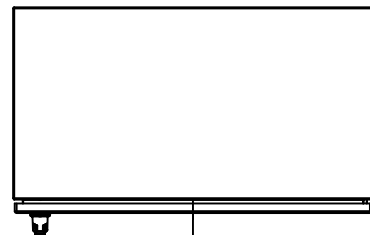

BOTTOM

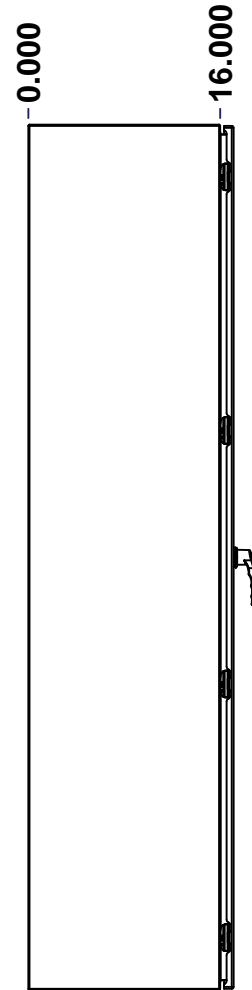

LEFT

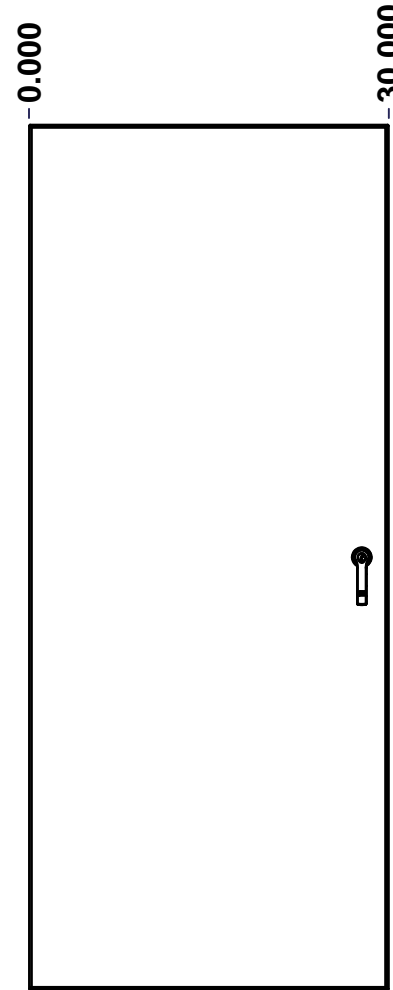

FRONT

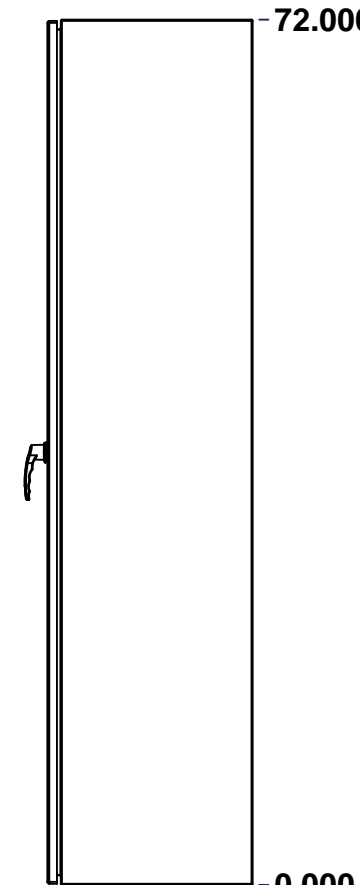

RIGHT

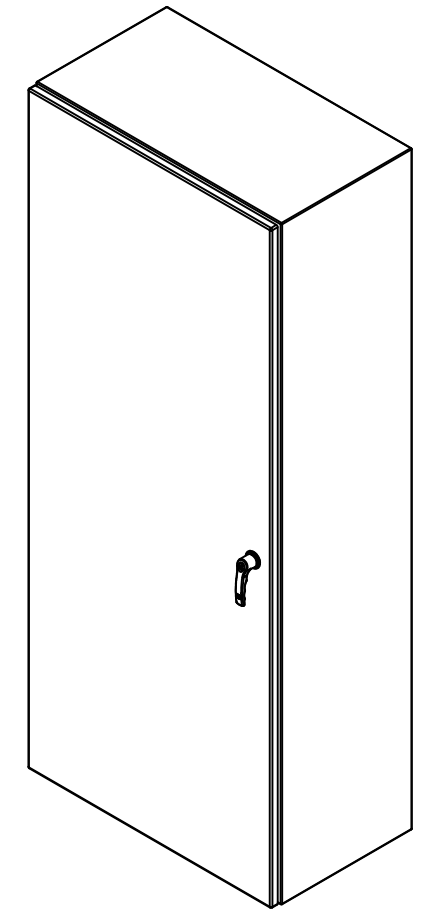

Isometric View



**GRAIN DIRECTION:
TOP/BOTTOM: HORIZONTAL
LEFT/RIGHT/BACK/FRONT: VERTICAL**

SEE BILL OF MATERIAL ON LAST PAGE

No.	Revisions	Date	By/Par

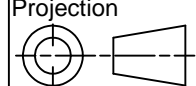
 Tél: (450) 979-4373 Fax: (450) 979-4626 www.exmweb.com		Flatness Aplatissement Max 3.0mm Projection 
Customer Client	Date	Date 13-May-14
Drawn By Dessiné Par	BoxCad: BoxCad	
Material Matière	14 Ga Stainless Steel 304 (1.7mm)	
Color Couleur	Unpainted	Finish Fini Brushed
Description	Detail Rev.	
5412ESSBU 72" x 30" x 16" Assembly		
Part Number Numéro Pièce	Rev.	1
5412ESSBU723016	0	2

This drawing is confidential and must not be reproduced or used without the consent of EXM

Ce dessin est confidentiel et ne doit pas être reproduit ou utilisé sans le consentement de EXM

NOTE	
ITEM	DESCRIPTION
1	NEMA 4X Enclosure
2	C/W Standard ground studs on box and cover
3	C/W Standard door stiffener
4	C/W Standard inner panel (Included)
5	C/W Standard inner panel mounting studs

No.	Revisions	Date	By/Par

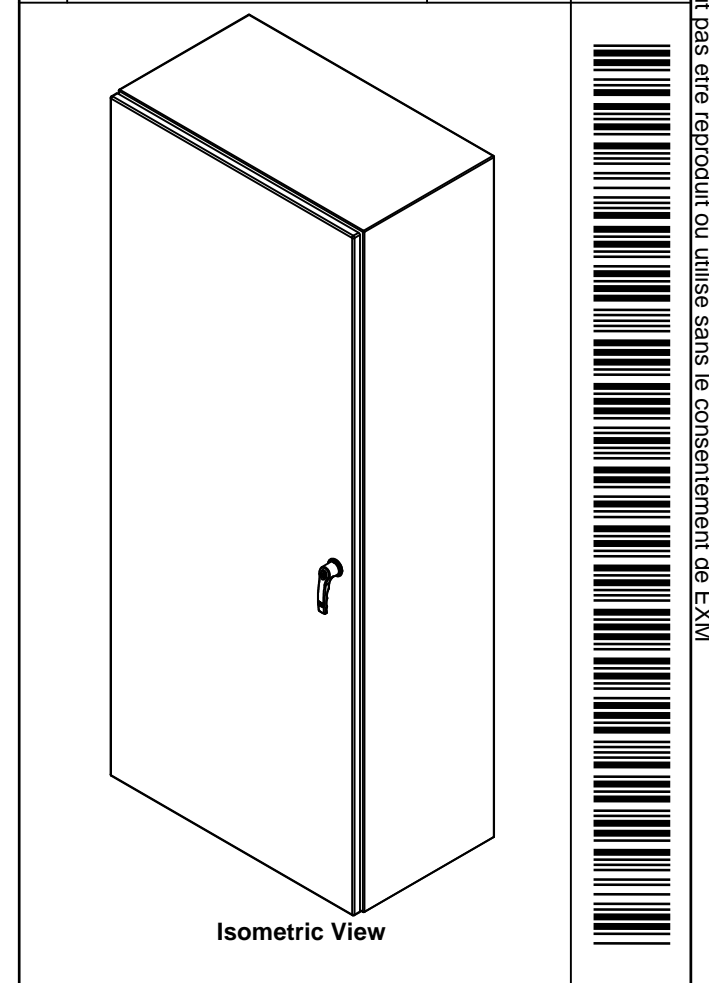

EXM
www.exm.com

Tél: (450) 979-4373
Fax: (450) 979-4626
www.exmweb.com

Flatness
Aplatissement
Max 3.0mm

Projection

PACKING		
ITEM	QTY	DESCRIPTION
Cardboard sleeve	2	Top and Bottom
Cardboard strip	2	Between back of enclosure and inner panel
Plastic bag	1	To protect cover surface and inside gasket
Cardboard corner	4	To reinforced for the plastic strap tightening
Plastic strap - Black	2	To Squeeze the 2 cardboard sleeve together
Packaging label	3	White label with PN
Plastic strap- Green	2	To secure the enclosure to the wood pallet
Wood Pallet	1	2" deeper and 3" larger than enclosure size

1	880 PP	6	Self Adhesive Print Pocket
1	STK-K-01800	5	5412 ES Accessory Kit
1	881 SP7230G	0	881 SP - Inner Panel
1	5412ESSBU723016C	0	5412ESSBU 72" x 30" Cover
6	STK-Q-07310	2	Flange Lock Nut M8
6	STK-Q-07610	8	M8 Plastic Spacer 22.2mm
1	5412ESSBU723016B	0	5412ESSBU 72" x 30" x 16" Body
8	STK-Q-04051-07	8	M6 x 7mm Stainless Steel Hexagon Socket Head Machine Screw with Nyseal
Qty	Part Number	Rev	Description
Parts List			

Customer Client

Drawn By
Dessiné Par BoxCad: BoxCad

Material
Matière 14 Ga Stainless Steel 304 (1.7mm)

Color
Couleur Unpainted

Finish
Fini Brushed

Description
5412ESSBU 72" x 30" x 16" Assembly

Part Number
Numéro Pièce **5412ESSBU723016**

Date 13-May-14

Detail Rev.

Rev.	2

This drawing is confidential and must not be reproduced or used without the consent of EXM

Ce dessin est confidentiel et ne doit pas être reproduit ou utilisé sans le consentement de EXM

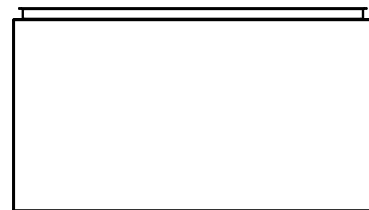

TOP



BACK

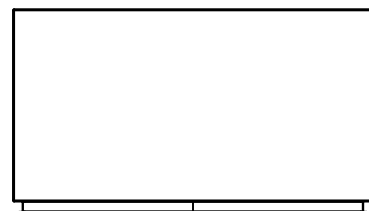

BOTTOM

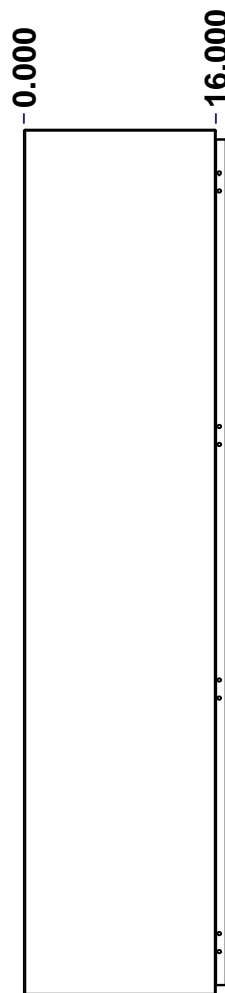

LEFT

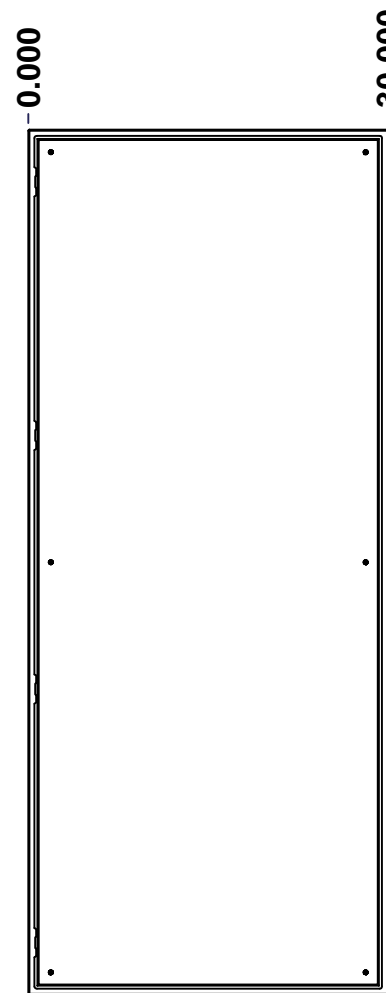

FRONT

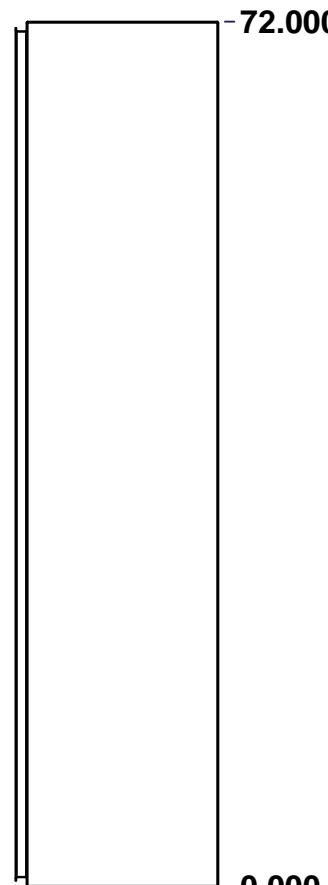

RIGHT

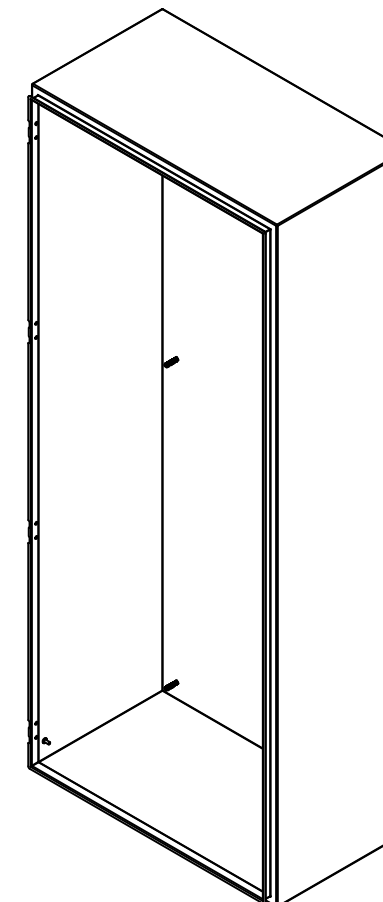

Isometric View

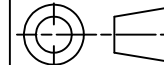

No.	Revisions	Date	By/Par

 Tél: (450) 979-4373 Fax: (450) 979-4626 www.exmweb.com		Flatness Aplatissement Max 3.0mm Projection 
Customer Client	Date	
Drawn By Dessiné Par	BoxCad: BoxCad	Date 13-May-14
Material Matière	14 Ga Stainless Steel 304 (1.7mm)	
Color Couleur	Unpainted	Finish Fini Brushed
Description	Detail Rev.	
5412ESSBU 72" x 30" x 16" Body		
Part Number Numéro Pièce	Rev.	1 7
5412ESSBU723016B	0	

SEE BILL OF MATERIAL ON LAST PAGE

This drawing is confidential and must not be reproduced or used without the consent of EXM

Ce dessin est confidentiel et ne doit pas être reproduit ou utilisé sans le consentement de EXM

STANDARD FEATURES ARE NOT LISTED IN THIS HOLE TABLE			
HOLE TABLE - LEFT VIEW (CUSTOM FEATURE ONLY)			
CUT-OUT	XDIM	YDIM	DESCRIPTION
1	14.500	2.000	GND STUD M6 x 16mm (Inside)

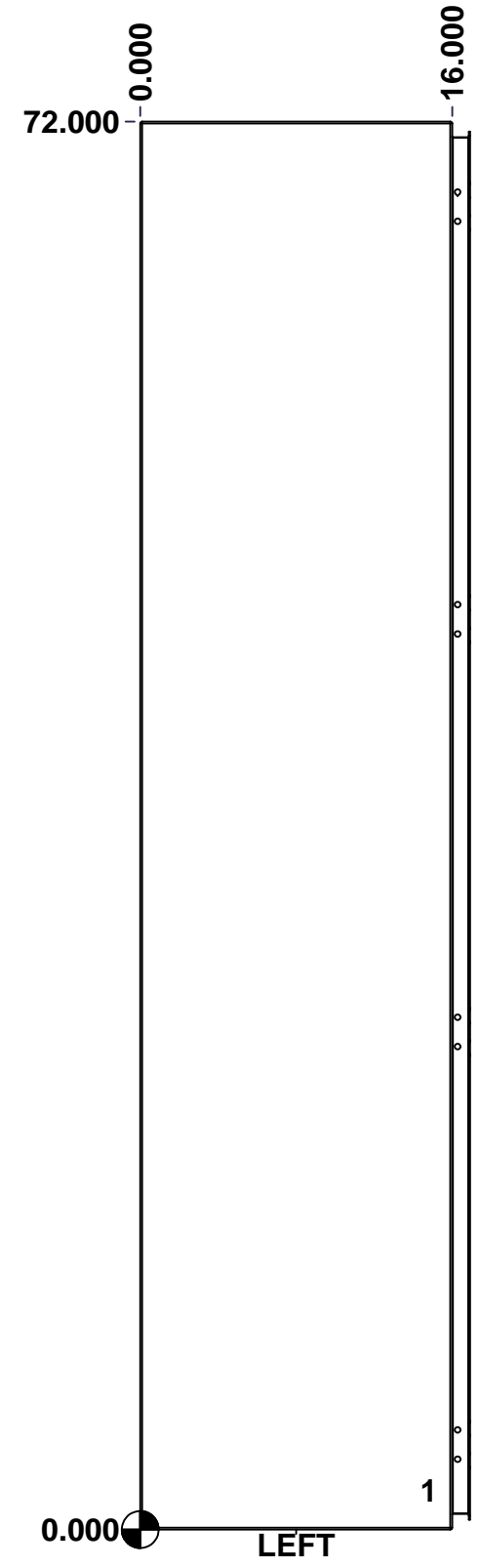

	Description	Status	
	5412ESSBU 72" x 30" x 16" Body		
	Part Number Numéro Pièce	Rev.	
	5412ESSBU723016B	0	5 / 7

This drawing is confidential and must not be reproduced or used without the consent of EXM

Ce dessin est confidentiel et ne doit pas être reproduit ou utilisé sans le consentement de EXM

STANDARD FEATURES ARE NOT LISTED IN THIS HOLE TABLE

HOLE TABLE - BACK VIEW (CUSTOM FEATURE ONLY)

CUT-OUT	XDIM	YDIM	DESCRIPTION
1	1.875	1.875	IP STUD M8 x 35mm (Inside)
2	1.875	70.125	IP STUD M8 x 35mm (Inside)
3	28.125	70.125	IP STUD M8 x 35mm (Inside)
4	28.125	1.875	IP STUD M8 x 35mm (Inside)
5	1.875	36.000	IP STUD M8 x 35mm (Inside)
6	28.125	36.000	IP STUD M8 x 35mm (Inside)

7	29.250	0.750	RND Ø0.390
8	29.250	71.250	RND Ø0.390
9	0.750	71.250	RND Ø0.390
10	0.750	0.750	RND Ø0.390

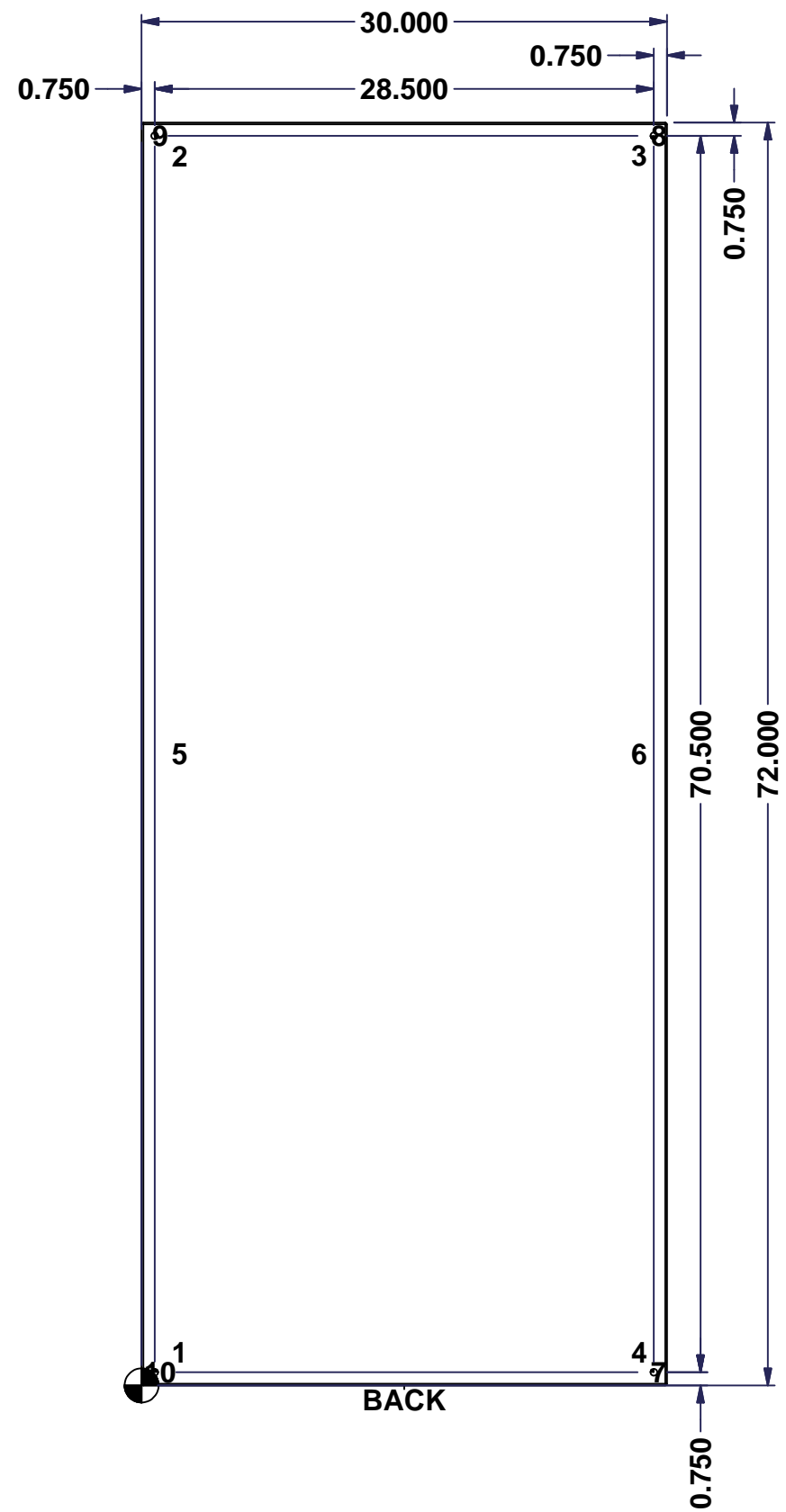

	Description		Status
	5412ESSBU 72" x 30" x 16" Body		
	Part Number Numéro Pièce		Rev.
	5412ESSBU723016B		6 0 7

This drawing is confidential and must not be reproduced or used without the consent of EXM

Ce dessin est confidentiel et ne doit pas être reproduit ou utilisé sans le consentement de EXM

No.	Revisions	Date	By/Par

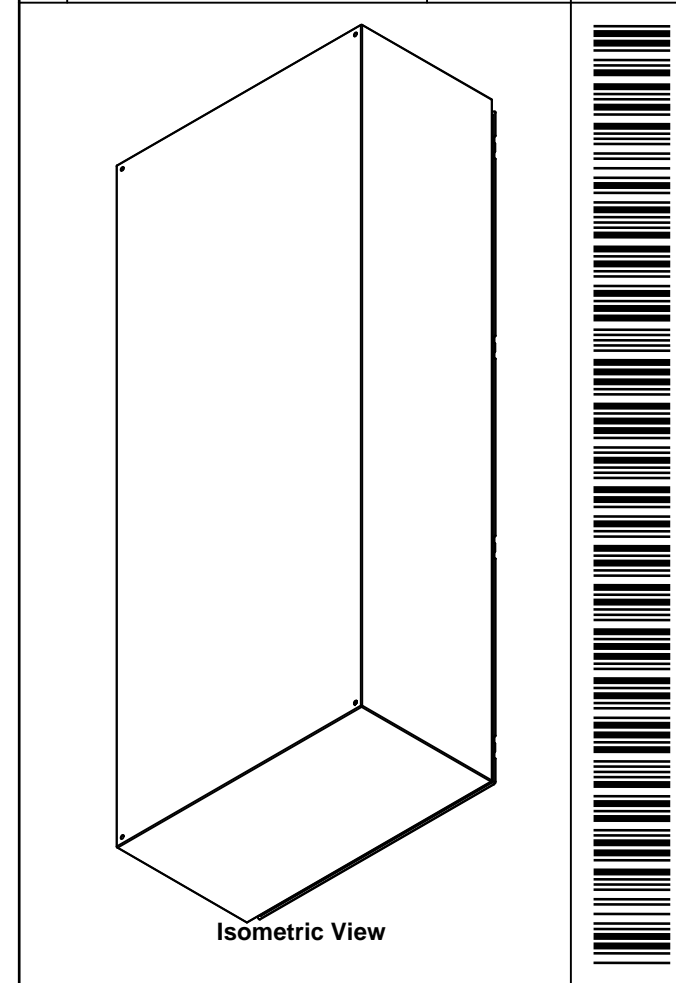

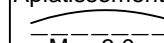
 Tél: (450) 979-4373 Fax: (450) 979-4626 www.exmweb.com		Flatness Aplatissement  Max 3.0mm Projection 
Customer Client	Date	
Drawn By Dessiné Par	BoxCad: BoxCad	Date 13-May-14
Material Matière	14 Ga Stainless Steel 304 (1.7mm)	
Color Couleur	Unpainted	Finish Fini Brushed
Description		Detail Rev.
5412ESSBU 72" x 30" x 16" Body		
Part Number Numéro Pièce	Rev.	7
5412ESSBU723016B	0	7

Qty	Part Number	Rev	Description
1	STK-Q-16085	0	Ground Stud M6 x 16mm Stainless Steel
6	STK-Q-16020	1	Stud M8 x 35mm Stainless Steel
1	5412ESSBU723016B-P	0	5412ESSBU 72" x 30" x 16" Body Part
Parts List			

This drawing is confidential and must not be reproduced or used without the consent of EXM

Ce dessin est confidentiel et ne doit pas être reproduit ou utilisé sans le consentement de EXM

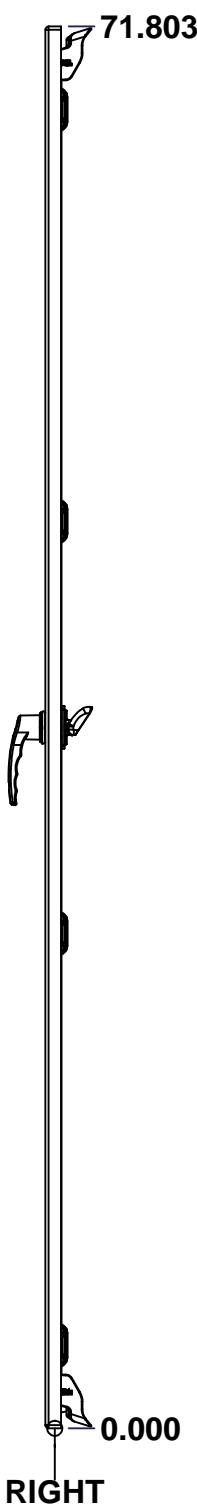
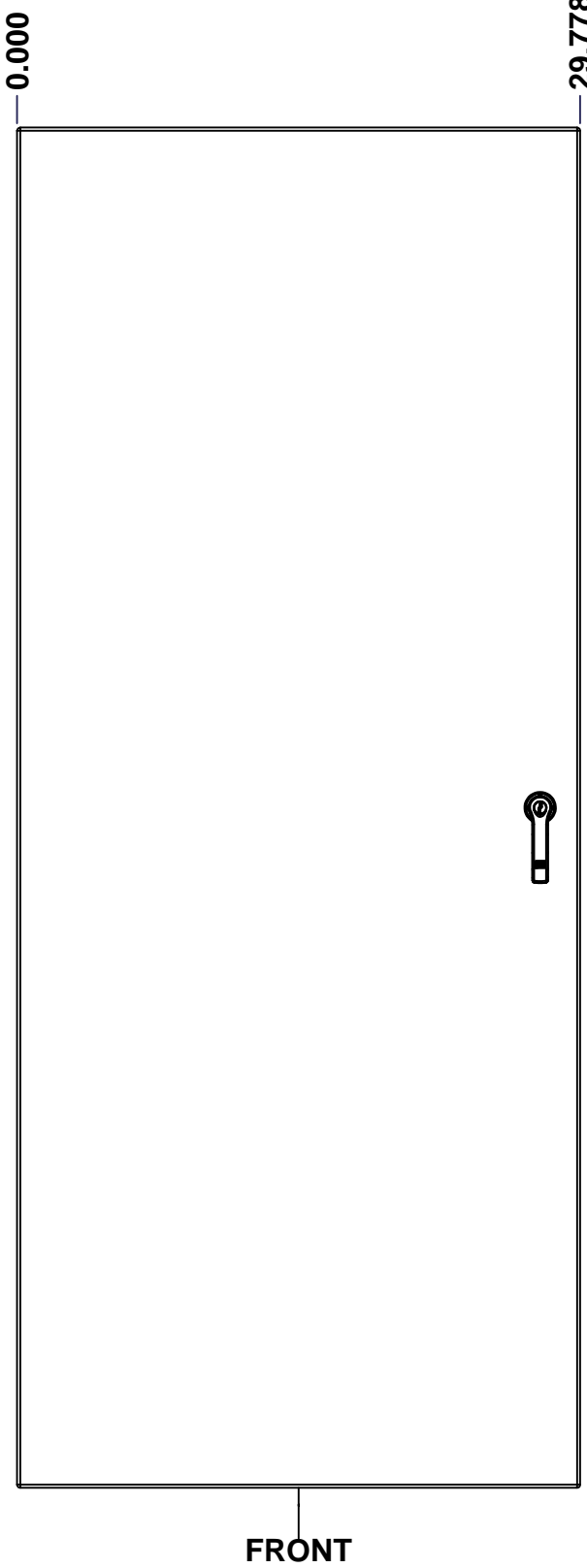
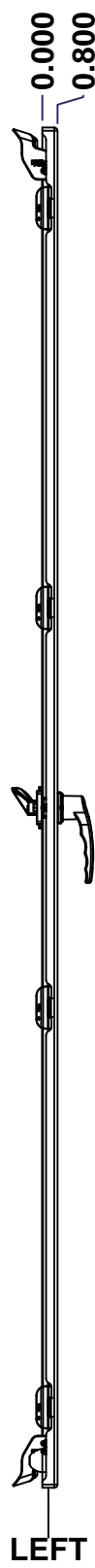
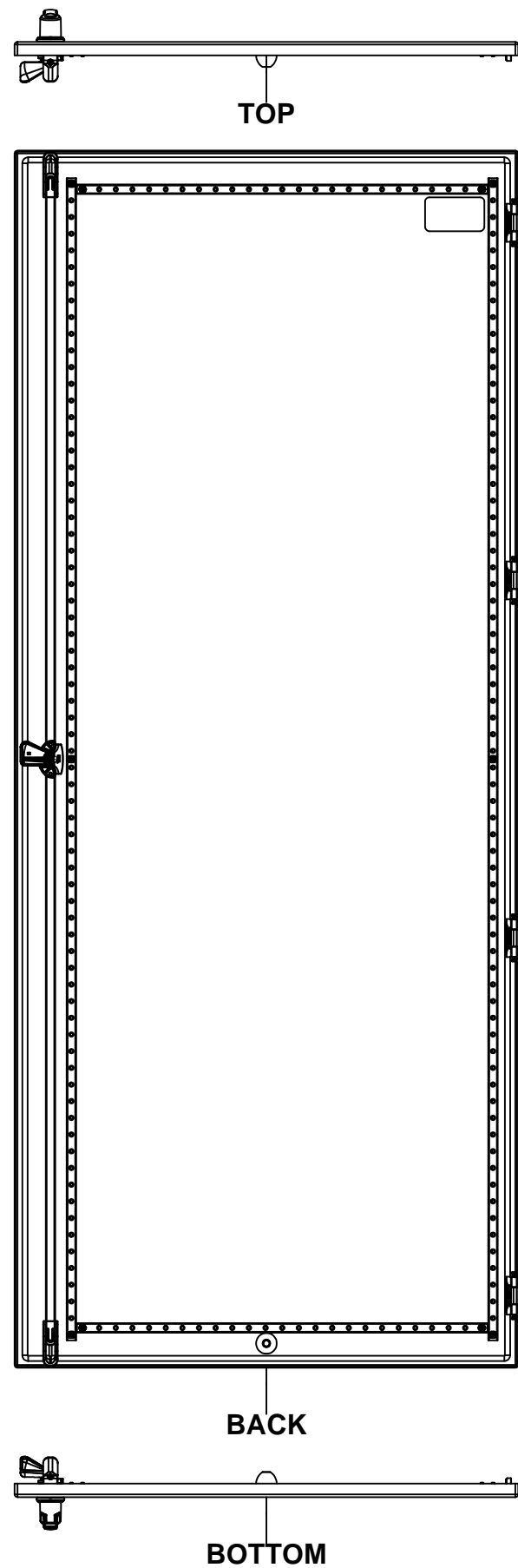

No.	Revisions	Date	By/Par

Isometric View

<p>Tél: (450) 979-4373 Fax: (450) 979-4626 www.exmweb.com</p>		Flatness Aplatissement	
		Max 3.0mm	
Customer Client		Projection	
Date			
Drawn By Dessiné Par	BoxCad: BoxCad	Date 13-May-14	
Material Matière		14 Ga Stainless Steel 304 (1.7mm)	
Color Couleur	Unpainted	Finish Fini	Brushed
Description		Detail Rev.	
5412ESSBU 72" x 30" Cover			
Part Number Numéro Pièce		Rev.	1
SEE BILL OF MATERIAL ON LAST PAGE		0	3

SEE BILL OF MATERIAL ON LAST PAGE **5412ESSBU723016C**

This drawing is confidential and must not be reproduced or used without the consent of EXM

Ce dessin est confidentiel et ne doit pas être reproduit ou utilisé sans le consentement de EXM

STANDARD FEATURES ARE NOT LISTED IN THIS HOLE TABLE

HOLE TABLE - FRONT VIEW (CUSTOM FEATURE ONLY)

CUT-OUT	XDIM	YDIM	DESCRIPTION
1	1.486	1.945	STUD M6 x 18mm (Inside)
2	1.486	69.858	STUD M6 x 18mm (Inside)
3	26.423	69.858	STUD M6 x 18mm (Inside)
4	26.423	1.945	STUD M6 x 18mm (Inside)
5	1.486	35.902	STUD M6 x 18mm (Inside)
6	26.423	35.902	STUD M6 x 18mm (Inside)
7	2.143	2.350	STUD M6 x 18mm (Inside)
8	2.143	69.524	STUD M6 x 18mm (Inside)
9	25.766	69.524	STUD M6 x 18mm (Inside)
10	25.766	2.350	STUD M6 x 18mm (Inside)
11	27.663	66.896	CLOSING BAR STUD (Inside)
12	27.663	4.907	CLOSING BAR STUD (Inside)
13	14.959	1.435	STUD M6 x 18mm (Inside)

14	3.750	68.053	LABEL_EXM (Inside)
15	27.663	35.902	HANDLE 885 ESL2A-LSS @ 0.0°

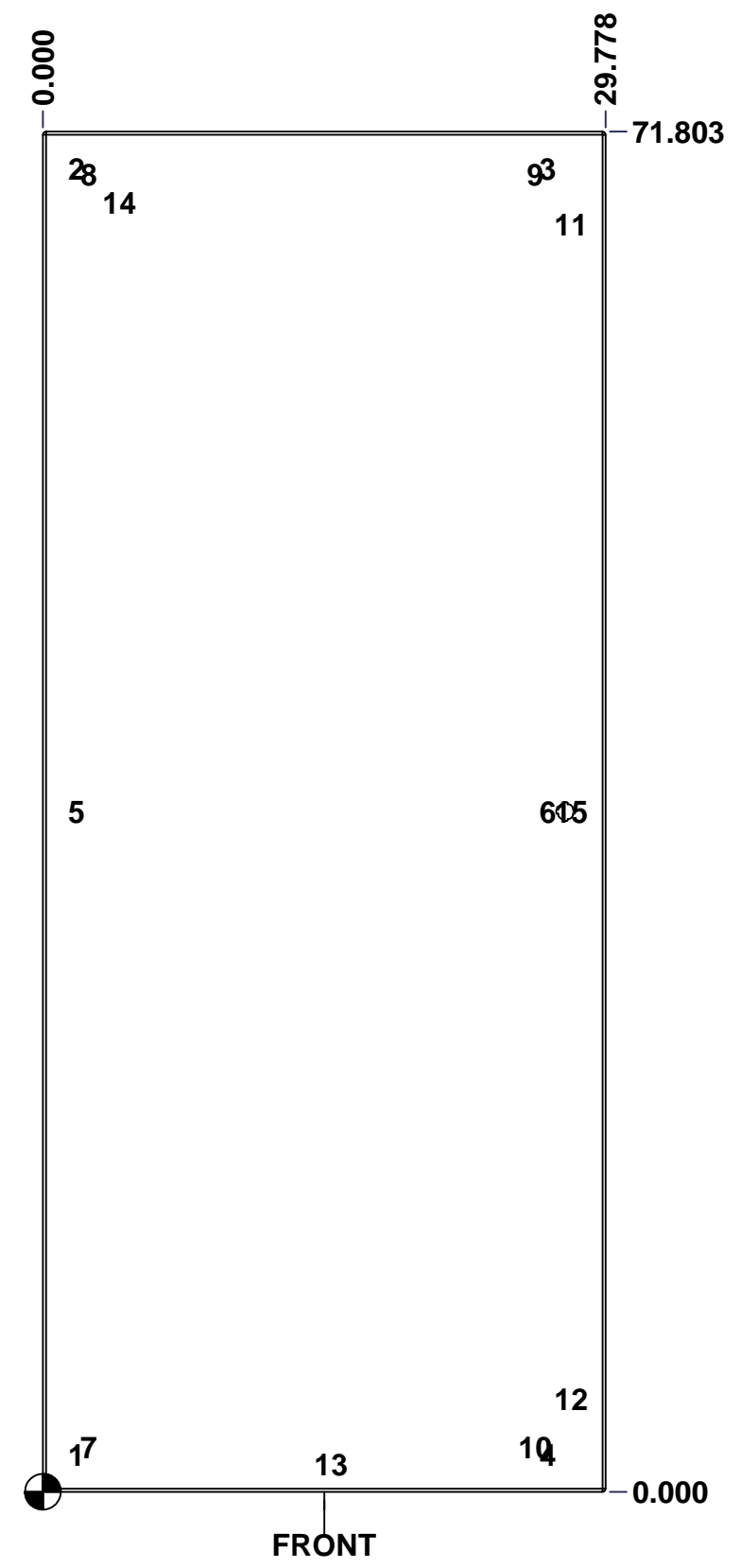

	Description	Status
	5412ESSBU 72" x 30" Cover	(NULL)
	Part Number Numéro Pièce	Rev.
	5412ESSBU723016C	0
		2
		3

This drawing is confidential and must not be reproduced or used without the consent of EXM

Ce dessin est confidentiel et ne doit pas être reproduit ou utilisé sans le consentement de EXM

No.	Revisions	Date	By/Par

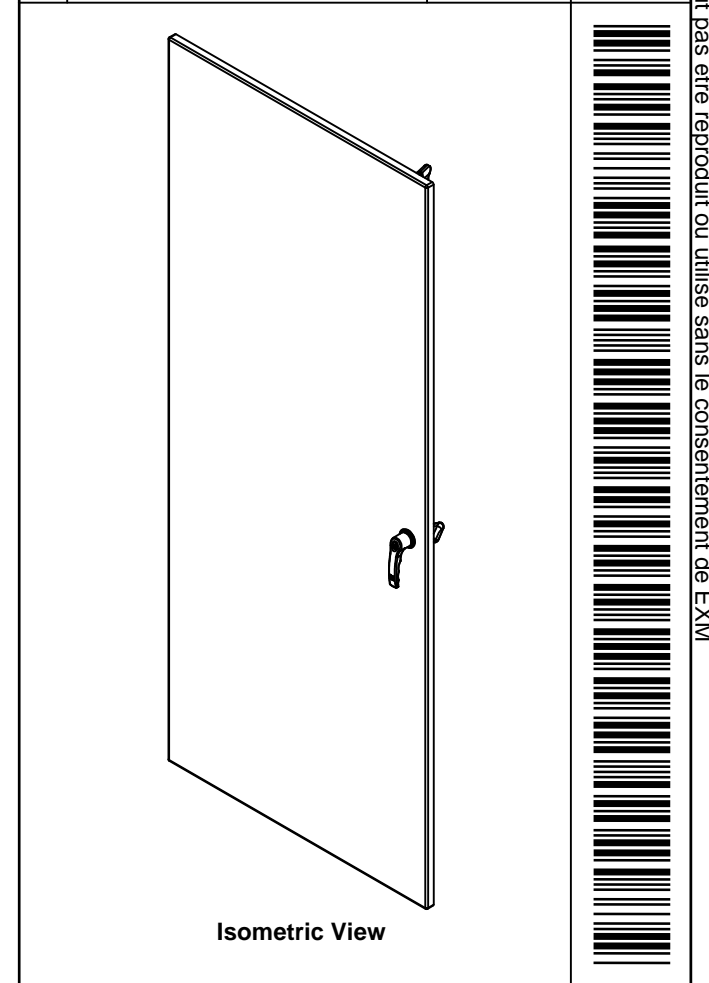

2	STK-Q-90042	4	5412 ES - Cabinet Closing Bar End (Small)
2	STK-Q-45655-72	0	5412 ES - Closing Bar
1	STK-Q-50536	11	5412 ES - Handle Cam Clockwise (Grip 32mm)
1	885 ESL2A-LSS	3	5412 ESS Key Lock L-Handle (3 Pts)
1	STK-S-00100	0	3.5" x 2" Silver Milar Flexcon Sticker
1	STK-Q-46515	3	5412 ES Door Support with Brass Insert
11	STK-Q-16070	1	Stud M6 x 18mm Stainless steel
1	5412ESSBU723016G	0	5412ESSBU 72" x 30" Cover Gasket Part
4	STK-A-33006	2	5412 ESSBU Hinge 180° (Body Part)
2	STK-Q-46025-30-3	4	5412 ES Horizontal Door Stiffener 30" (3Pts)
2	STK-Q-46020-72	5	5412 ES Vertical Door Stiffener 72"
2	STK-Q-16407	2	Guide Stud - Small (No Paint Cap Required)
1	5412ESSBU723016C-P	0	5412ESSBU 72" x 30" Cover Part
10	STK-Q-07220	1	M6 Nylon Insert Lock Nut
Qty	Part Name	Rev	Description
Parts List			

<p>Tél: (450) 979-4373 Fax: (450) 979-4626 www.exmweb.com</p>	Flatness Aplatissement
	Max 3.0mm
Projection	
Customer Client	Date
Drawn By Dessiné Par	Date 13-May-14
Material Matière	14 Ga Stainless Steel 304 (1.7mm)
Color Couleur	Unpainted
Finish Fini	Brushed
Description	Detail Rev.
5412ESSBU 72" x 30" Cover	
Part Number Numéro Pièce	Rev. 3
5412ESSBU723016C	0 3

This drawing is confidential and must not be reproduced or used without the consent of EXM

Ce dessin est confidentiel et ne doit pas être reproduit ou utilisé sans le consentement de EXM

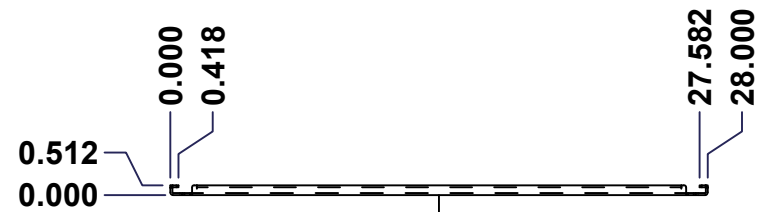

TOP

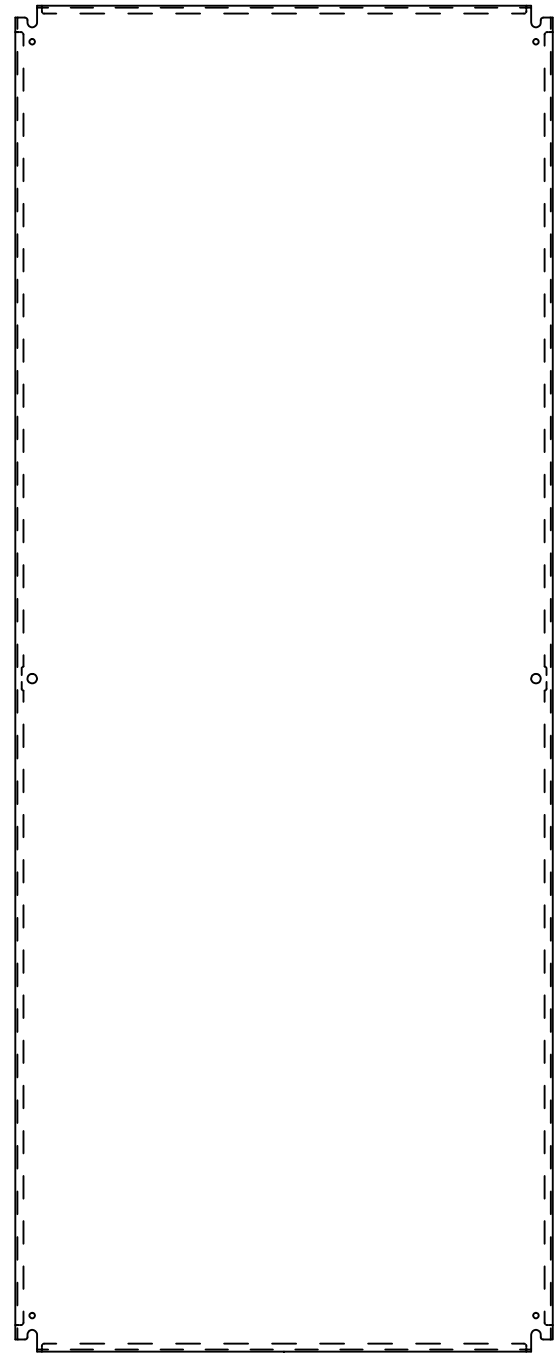

FRONT

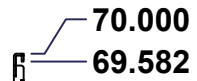

RIGHT

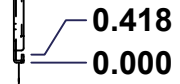

No.	Revisions	Date	By/Par

Isometric View

		Flatness Aplatissement Max 3.0mm	
Tél: (450) 979-4373 Fax: (450) 979-4626 www.exmweb.com		Projection 	
Customer Client		Date	
Drawn By / Dessiné Par: BoxCad		Date: 1/23/2007	
Material / Matière: See Part List			
Color / Couleur: See Part List		Finish / Fini: See Part List	
Description: 881 SP - Inner Panel			Detail Rev.
Part Number / Numéro Pièce: 881 SP7230G			Rev. 1/2

Qty	Part Number	Rev	Description	Material	Color	Finish
1	881 SP7230G-P	0	881 SP - Inner Panel Part	12 Ga Galvanized	Unpainted	Galvanized

Parts List

This drawing is confidential and must not be reproduced or used without the consent of EXM

Ce dessin est confidentiel et ne doit pas être reproduit ou utilisé sans le consentement de EXM

Table 1			FRONT VIEW
CUT-OUT	XDIM	YDIM	DESCRIPTION
1	0.875	1.875	GROUND HOLE (RND Ø0.290)
2	27.125	1.875	GROUND HOLE (RND Ø0.290)
3	0.875	68.125	GROUND HOLE (RND Ø0.290)
4	27.125	68.125	GROUND HOLE (RND Ø0.290)
5	0.875	35.000	MTG STUD HOLE (RND Ø0.500)
6	27.125	35.000	MTG STUD HOLE (RND Ø0.500)

All knockouts are actual size / Les disques défonçables sont grandeur réel

No.	Revisions	Date	By/Par

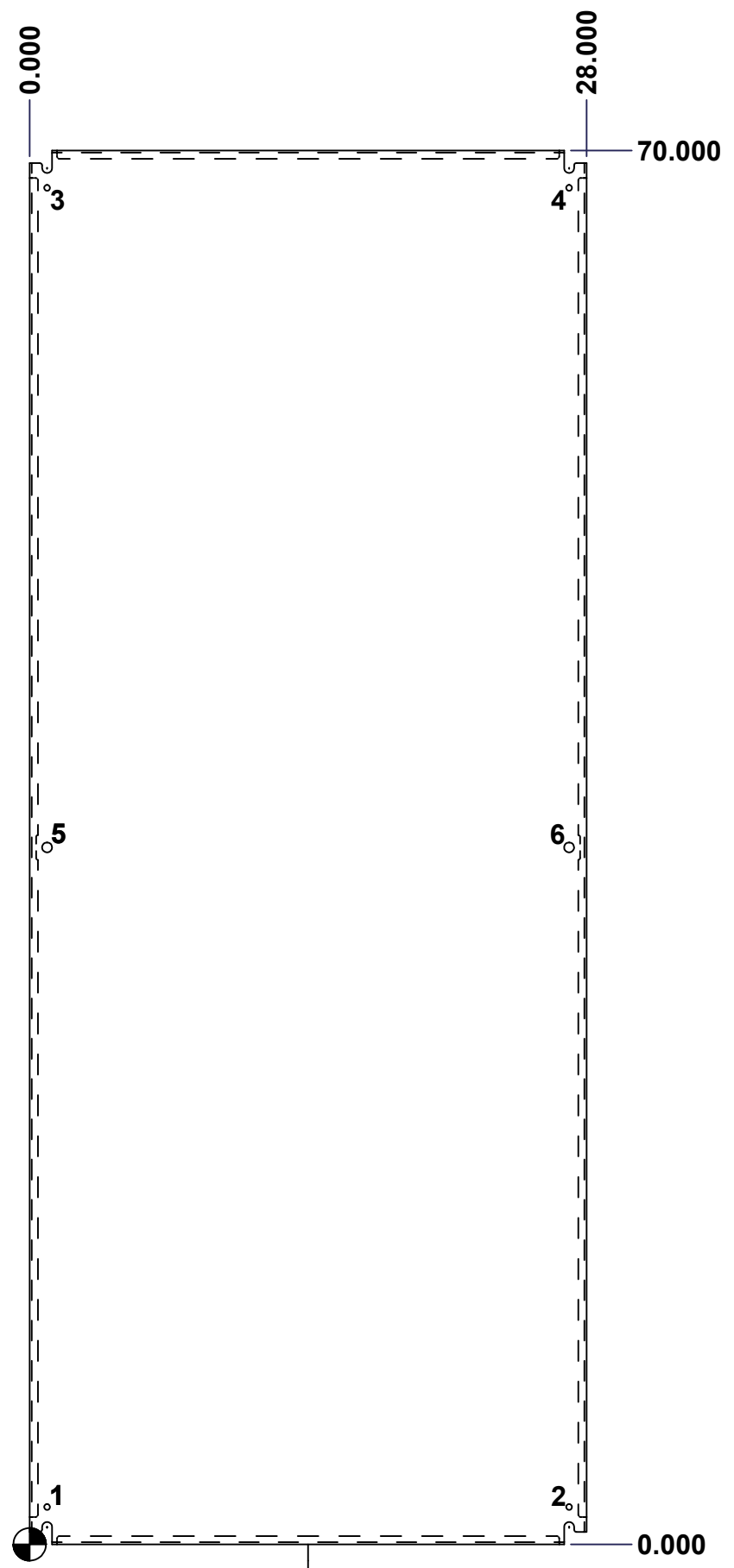

FRONT

Isometric View

		Tél: (450) 979-4373 Fax: (450) 979-4626 www.exmweb.com		Flatness Aplatissement Max 3.0mm
Customer Client		Date		Projection
Drawn By Dessiné Par BoxCad		Date 1/23/2007		
Material Matière See Part List				
Color Couleur See Part List		Finish Fini See Part List		
Description 881 SP - Inner Panel			Detail Rev.	
Part Number Numéro Pièce 881 SP7230G			Rev. 0	2 2