

This drawing is confidential and must not be reproduced or used without the consent of EXM

Ce dessin est confidentiel et ne doit pas être reproduit ou utilisé sans le consentement de EXM

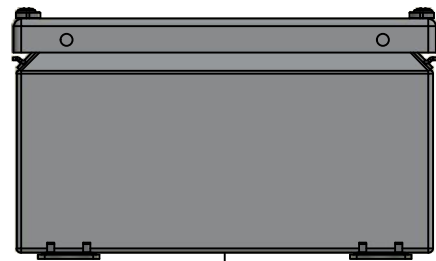

TOP

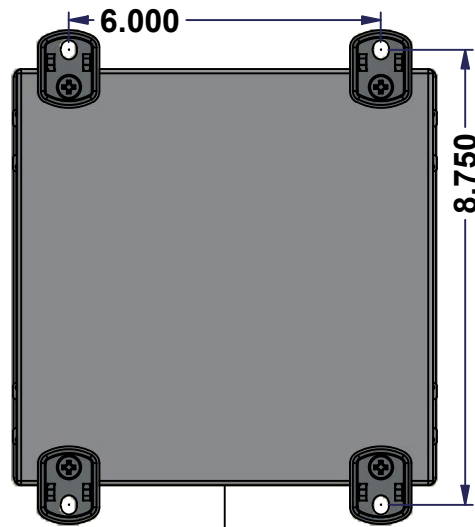

BACK

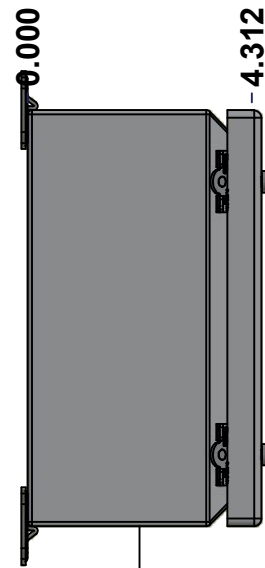

LEFT

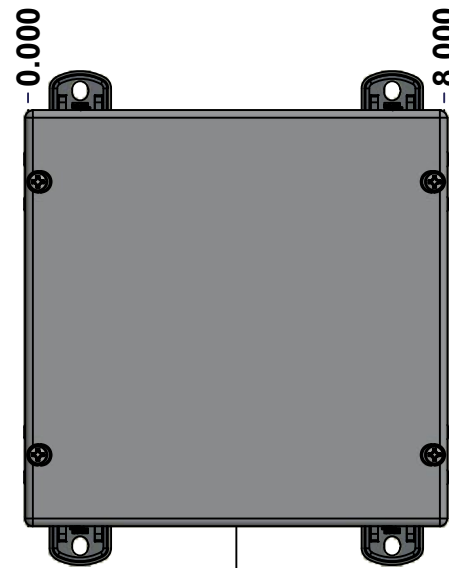

FRONT

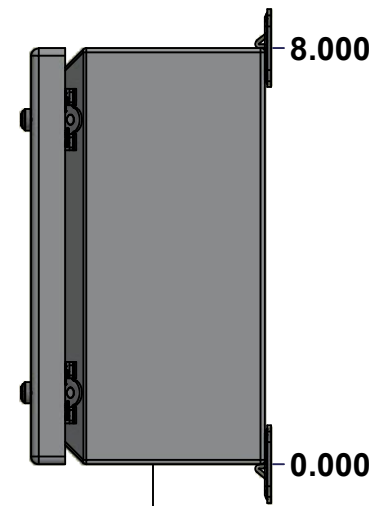

RIGHT

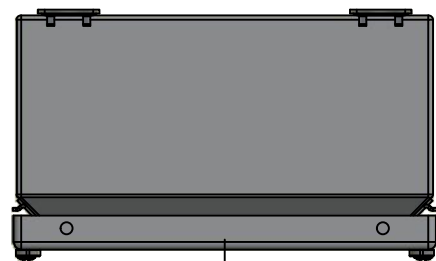

BOTTOM

No.	Revisions	Date	By/Par

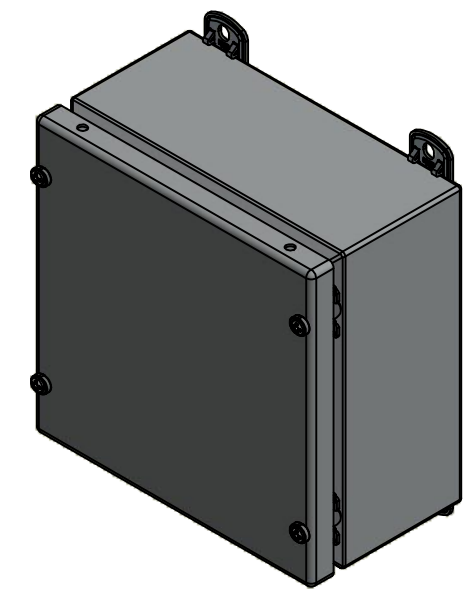

Isometric View



Tél: (450) 979-4373
 Fax: (450) 979-4626
www.exmweb.com

Flatness
Aplatissement
Max 3.0mm
Projection

Customer Client	Date
Drawn By Dessiné Par BoxCad: BoxCad	Date 6/13/2013
Material Matière 16 Ga Cold Rolled A1008 CS Type B (1.4mm)	
Color Couleur Asa-61 Grey	Finish Fini Smooth
Description 5412ESSC 8" x 8" x 4" Assembly	Detail Rev.
Part Number Numéro Pièce 5412ESSC080804	Rev. 1

SEE BILL OF MATERIAL ON LAST PAGE

5412ESSC080804

Rev. 0	1
	9

This drawing is confidential and must not be reproduced or used without the consent of EXM

Ce dessin est confidentiel et ne doit pas être reproduit ou utilisé sans le consentement de EXM

NOTE	
ITEM	DESCRIPTION
1	NEMA 4/12 Enclosure
2	C/W Standard ground standoffs on box and cover
3	W/O Standard door stiffener
4	C/W Standard inner panel (Included)
5	C/W Standard inner panel mounting standoffs

No.	Revisions	Date	By/Par

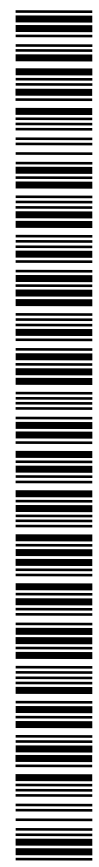
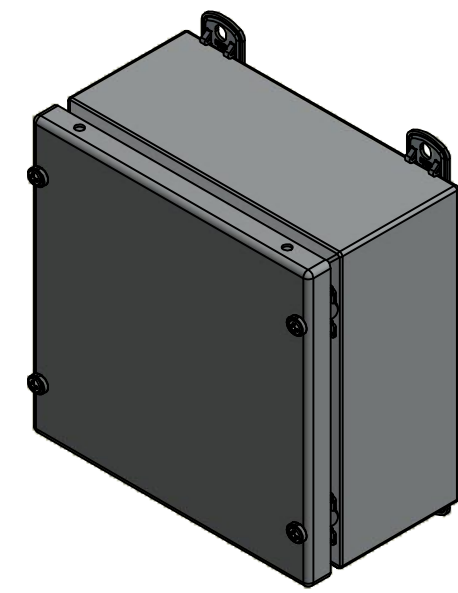

Isometric View



Tél: (450) 979-4373
 Fax: (450) 979-4626
www.exmweb.com

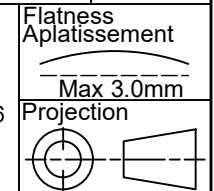

Customer Client	Date
Drawn By / Dessiné Par: BoxCad: BoxCad	Date: 6/13/2013
Material / Matière: 16 Ga Cold Rolled A1008 CS Type B (1.4mm)	

Color / Couleur: Asa-61 Grey	Finish / Fini: Smooth
------------------------------	-----------------------

Description: 5412ESSC 8" x 8" x 4" Assembly	Detail Rev.
---	-------------

Part Number / Numéro Pièce: 5412ESSC080804	Rev. 0	2/9
---	--------	-----

PACKING		
ITEM	QTY	DESCRIPTION
STK-E-04308	1	CARTON 5412 ESCH080804
Plastic bag	1	To protect cover surface and inside gasket
Packaging label	1	White label with product number
STK-S-01100	1	ESCH EXM SQUARE STICKER

Qty	Part Number	Rev	Description
1	5412ESSC080804C	0	5412ESSC 8" x 8" Cover
1	880 SP0808G	0	880 SP0808G - Inner Panel
1	STK-K-02920	3	5412 ESSC Accessory Kit
1	5412ESSC080804B	0	5412ESSC 8" x 8" x 4" Body

Parts List

This drawing is confidential and must not be reproduced or used without the consent of EXM

Ce dessin est confidentiel et ne doit pas être reproduit ou utilisé sans le consentement de EXM

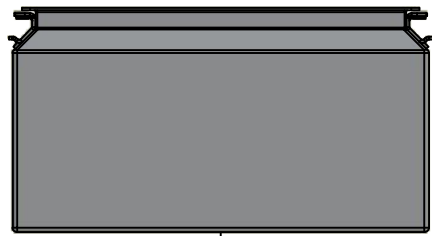

TOP

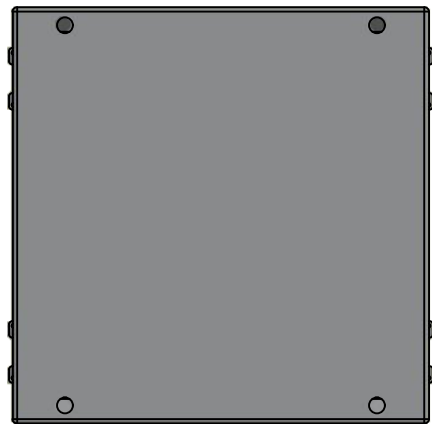

BACK

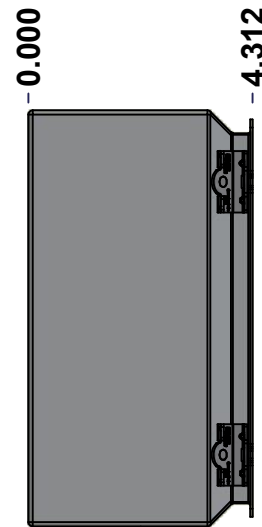

LEFT

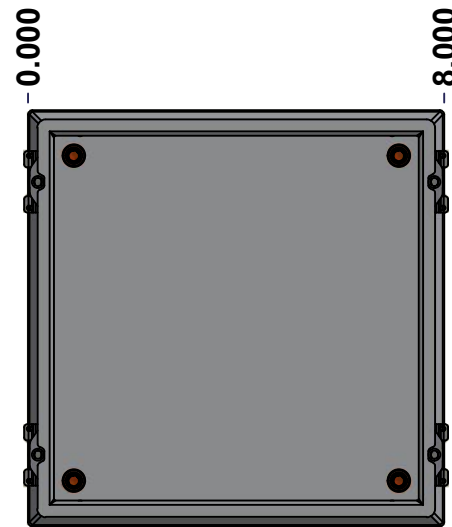

FRONT

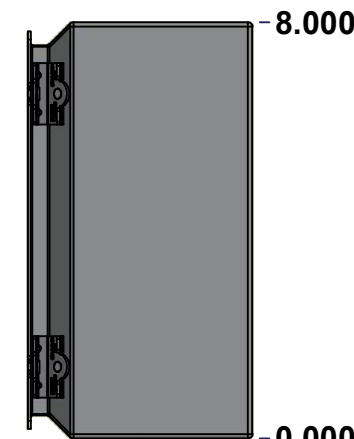

RIGHT



BOTTOM

No.	Revisions	Date	By/Par

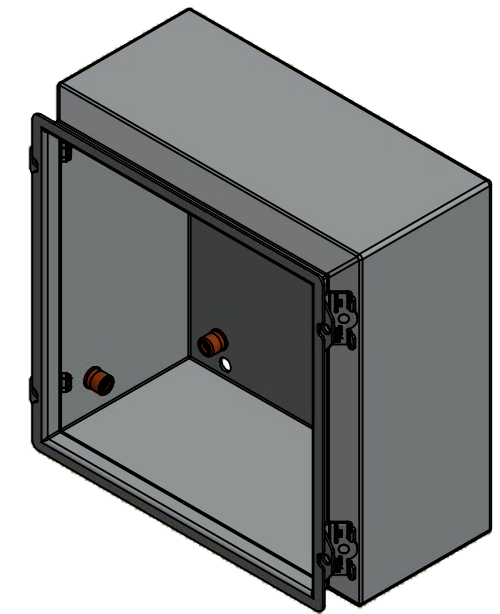

Isometric View



Tél: (450) 979-4373
 Fax: (450) 979-4626
www.exmweb.com

Flatness
Aplatissement

Max 3.0mm

Projection

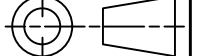

Customer Client	Date
Drawn By Dessiné Par BoxCad: BoxCad	Date 6/13/2013
Material Matière 16 Ga Cold Rolled A1008 CS Type B (1.4mm)	

Color Couleur Asa-61 Grey	Finish Fini Smooth
------------------------------	-----------------------

Description 5412ESSC 8" x 8" x 4" Body	Detail Rev.
---	-------------

Part Number Numéro Pièce 5412ESSC080804B	Rev. 0	3 9
---	------------------	----------------------

SEE BILL OF MATERIAL ON LAST PAGE

This drawing is confidential and must not be reproduced or used without the consent of EXM

Ce dessin est confidentiel et ne doit pas être reproduit ou utilisé sans le consentement de EXM

STANDARD FEATURES ARE NOT LISTED IN THIS HOLE TABLE			
HOLE TABLE - LEFT VIEW (CUSTOM FEATURE ONLY)			
CUT-OUT	XDIM	YDIM	DESCRIPTION
1	2.625	0.875	STANDOFF M6 x 10mm (Inside)

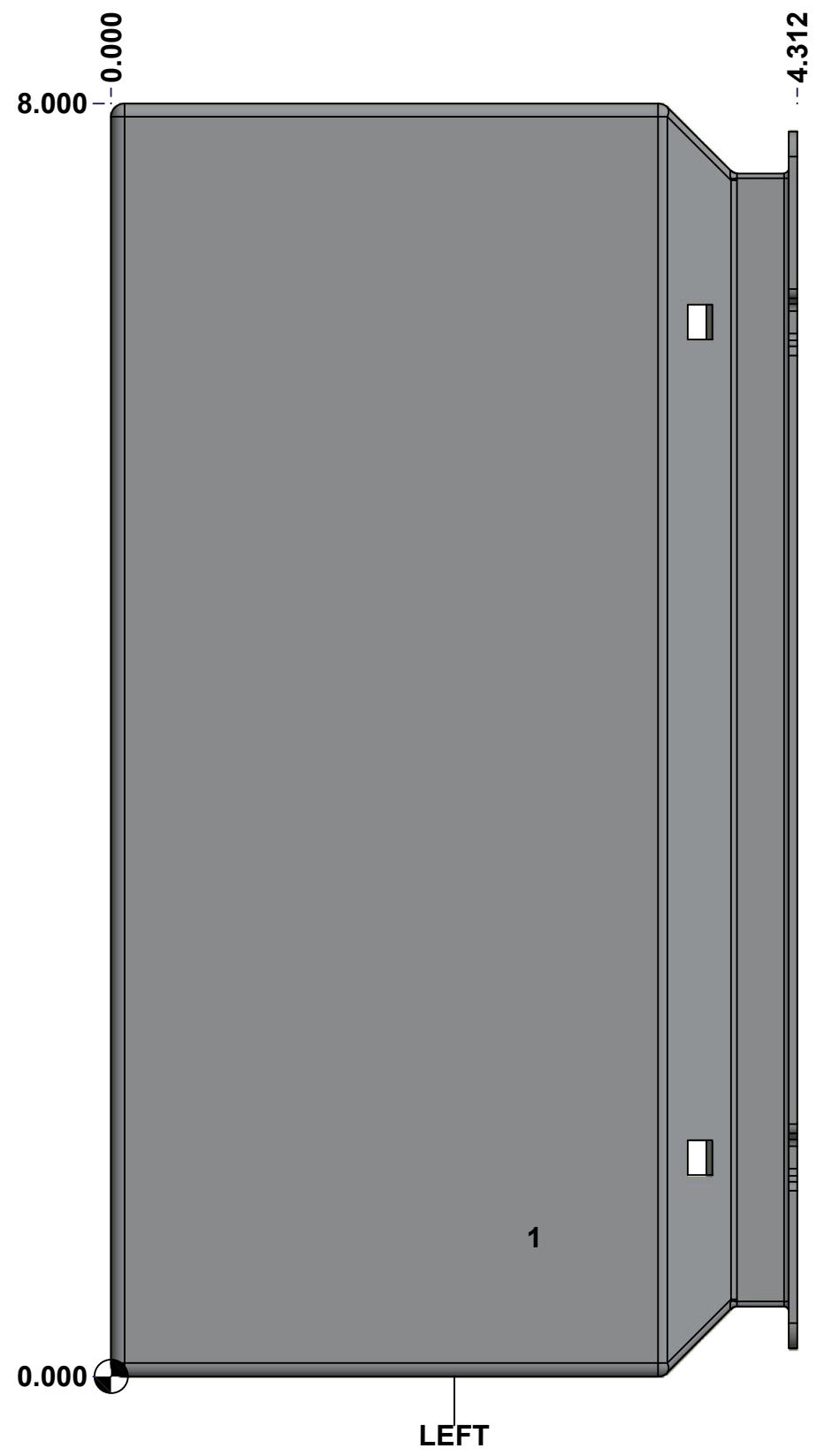

	Description	Status
	5412ESSC 8" x 8" x 4" Body	(NULL)
Part Number Numéro Pièce 5412ESSC080804B	Rev.	4
	0	9

This drawing is confidential and must not be reproduced or used without the consent of EXM

Ce dessin est confidentiel et ne doit pas être reproduit ou utilisé sans le consentement de EXM

STANDARD FEATURES ARE NOT LISTED IN THIS HOLE TABLE

HOLE TABLE - BACK VIEW (CUSTOM FEATURE ONLY)

CUT-OUT	XDIM	YDIM	DESCRIPTION
1	0.875	0.875	IP STANDOFF M6 x 10mm (Inside)
2	0.875	7.125	IP STANDOFF M6 x 10mm (Inside)
3	7.125	7.125	IP STANDOFF M6 x 10mm (Inside)
4	7.125	0.875	IP STANDOFF M6 x 10mm (Inside)

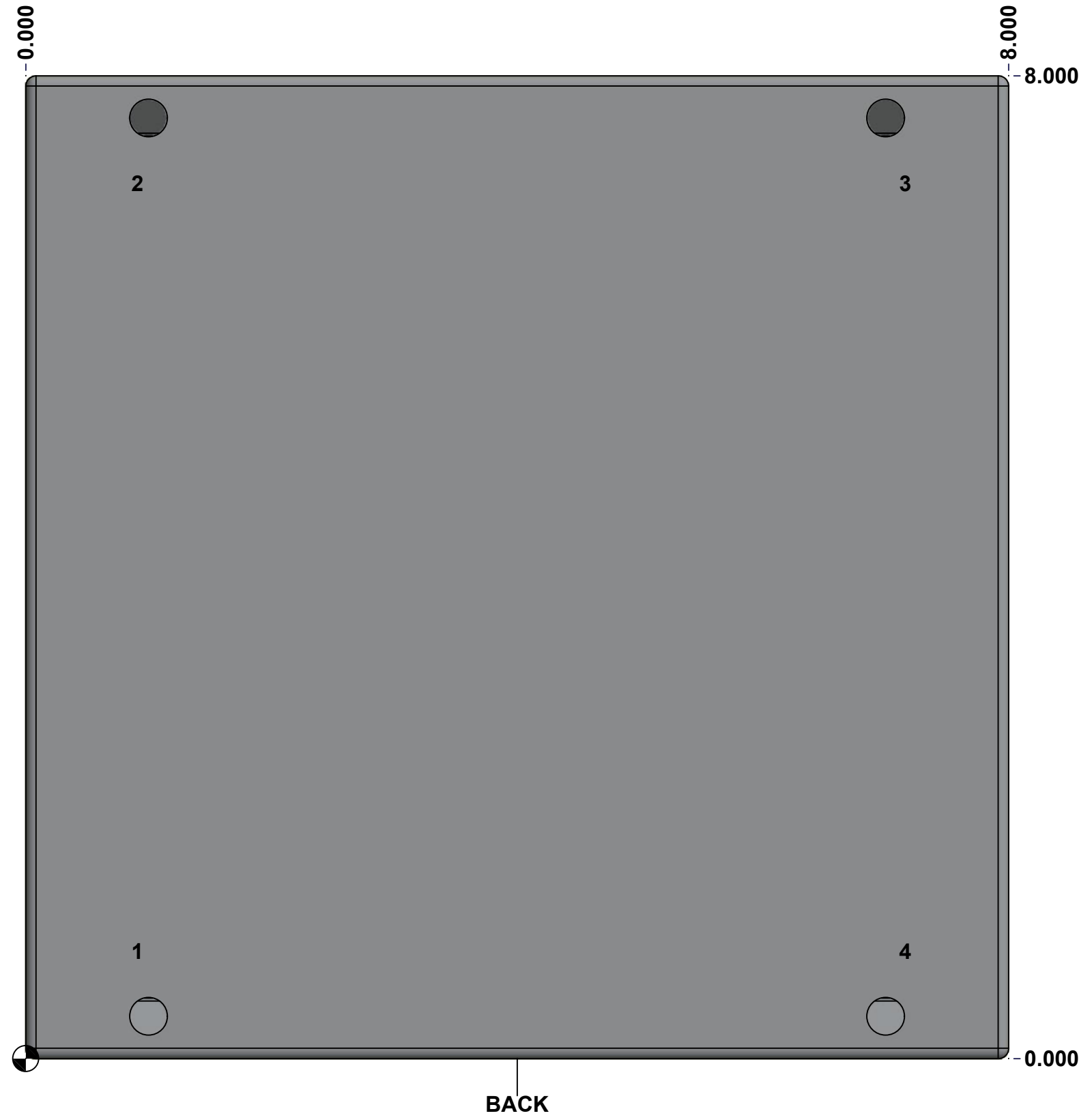

	Description		Status	
	5412ESSC 8" x 8" x 4" Body		(NULL)	
Part Number Numéro Pièce		Rev.	5	
5412ESSC080804B		0	9	

This drawing is confidential and must not be reproduced or used without the consent of EXM

Ce dessin est confidentiel et ne doit pas être reproduit ou utilisé sans le consentement de EXM

No.	Revisions	Date	By/Par

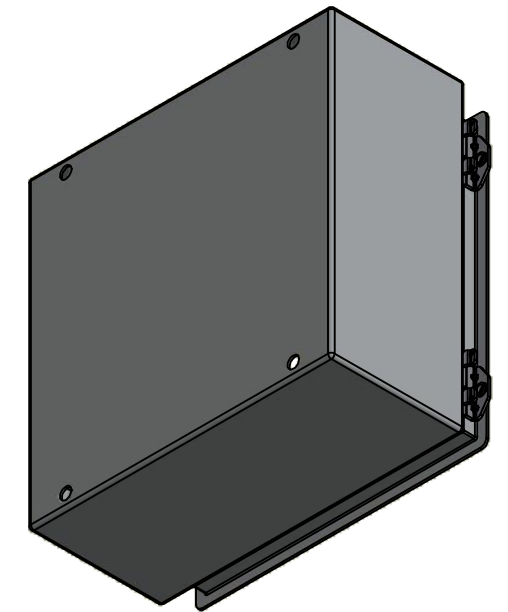

Isometric View



Tél: (450) 979-4373
 Fax: (450) 979-4626
www.exmweb.com

Flatness
Aplatissement

Max 3.0mm

Projection



Customer Client	Date
Drawn By / Dessiné Par: BoxCad: BoxCad	Date: 6/13/2013
Material / Matière: 16 Ga Cold Rolled A1008 CS Type B (1.4mm)	

Color / Couleur: Asa-61 Grey	Finish / Fini: Smooth
------------------------------	-----------------------

Description: 5412ESSC 8" x 8" x 4" Body	Detail Rev.
---	-------------

Part Number / Numéro Pièce: 5412ESSC080804B	Rev. 0	6/9
--	--------	-----

Qty	Part Number	Rev	Description
1	STK-P-02400S	0	Powder Paint (Asa-61 Grey / Smooth)
1	5412ESSC080804B-P	0	5412ESSC 8" x 8" x 4" Body Part
4	STK-Q-08100	1	M5 Nylon Insert Lock Nut
5	STK-Q-08350	5	Standoff M6 x 10mm
4	STK-Q-70464	2	5412 ESSC & ESSC Stainless Steel Body Catch Assembly
Parts List			

This drawing is confidential and must not be reproduced or used without the consent of EXM

Ce dessin est confidentiel et ne doit pas être reproduit ou utilisé sans le consentement de EXM



TOP

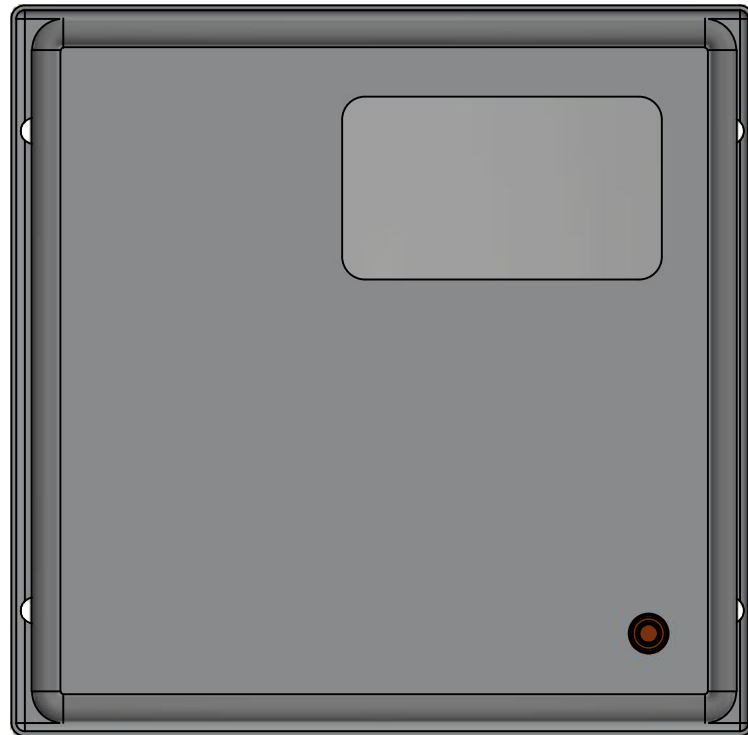

BACK



BOTTOM

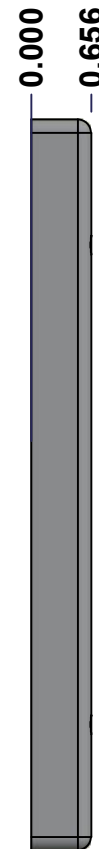

LEFT

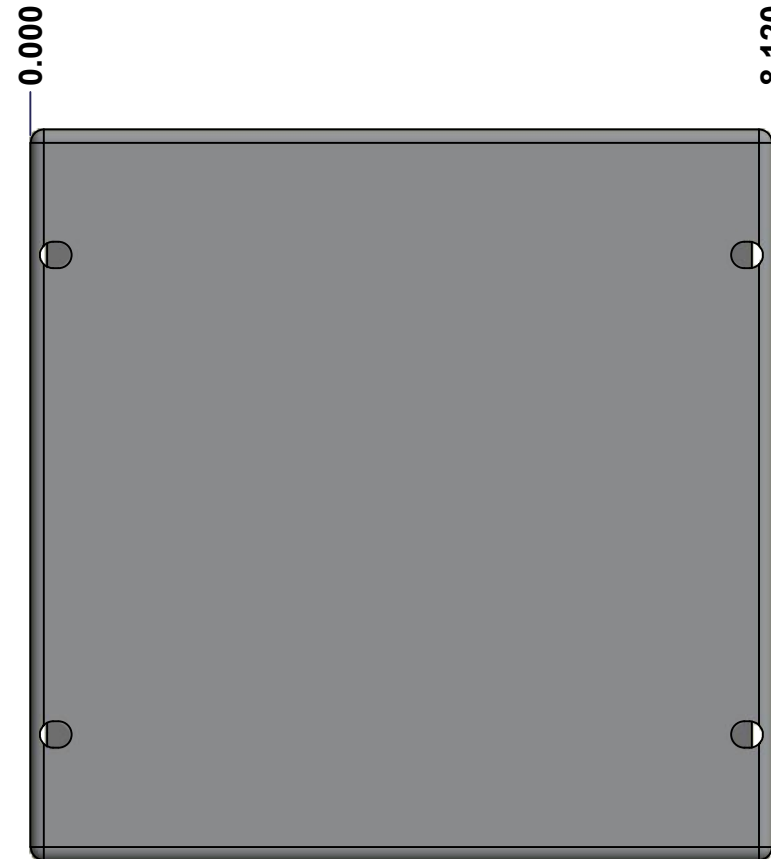

FRONT

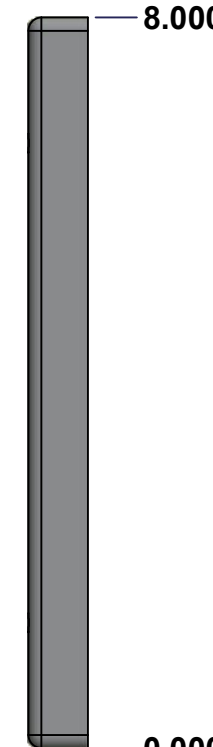

RIGHT

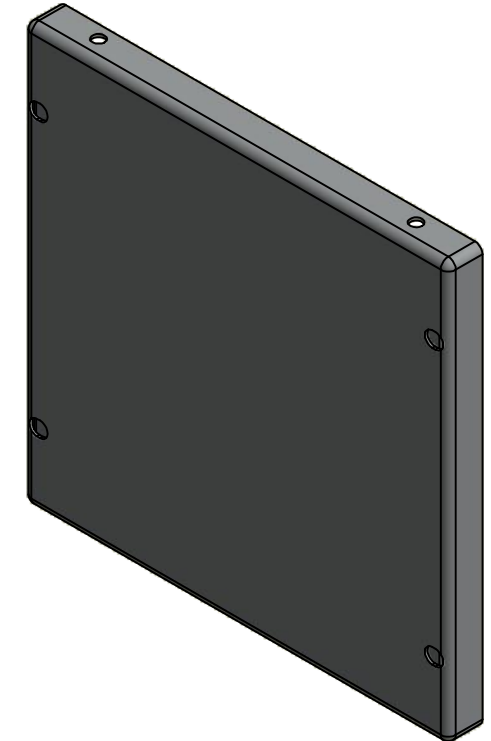

Isometric View

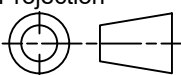

No.	Revisions	Date	By/Par

 Tél: (450) 979-4373 Fax: (450) 979-4626 www.exmweb.com		Flatness Aplatissement Max 3.0mm Projection 
Customer Client	Date	
Drawn By Dessiné Par	BoxCad: BoxCad	Date 6/13/2013
Material Matière	16 Ga Cold Rolled A1008 CS Type B (1.4mm)	
Color Couleur	Asa-61 Grey	Finish Fini Smooth
Description 5412ESSC 8" x 8" Cover		Detail Rev.
Part Number Numéro Pièce	5412ESSC080804C	Rev. 7 0

SEE BILL OF MATERIAL ON LAST PAGE

This drawing is confidential and must not be reproduced or used without the consent of EXM

Ce dessin est confidentiel et ne doit pas être reproduit ou utilisé sans le consentement de EXM

STANDARD FEATURES ARE NOT LISTED IN THIS HOLE TABLE			
HOLE TABLE - FRONT VIEW (CUSTOM FEATURE ONLY)			
CUT-OUT	XDIM	YDIM	DESCRIPTION
1	1.145	1.125	STANDOFF M6 x 10mm (Inside)
2	2.750	6.000	LABEL_EXM

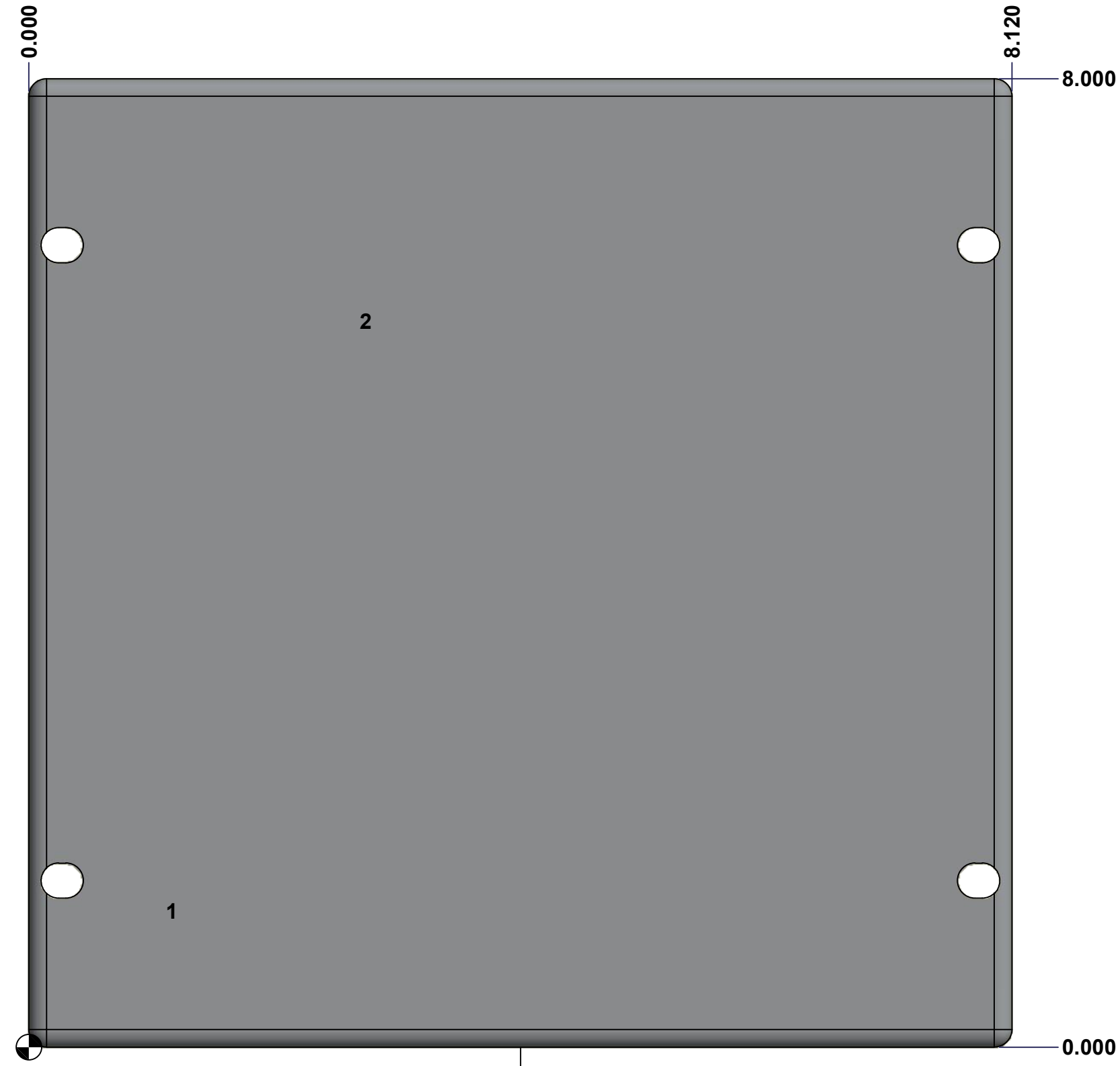

FRONT

	Description	Status
	5412ESSC 8" x 8" Cover	(NULL)
	Part Number Numéro Pièce	Rev.
	5412ESSC080804C	0
		8
		9

This drawing is confidential and must not be reproduced or used without the consent of EXM

Ce dessin est confidentiel et ne doit pas être reproduit ou utilisé sans le consentement de EXM

No.	Revisions	Date	By/Par

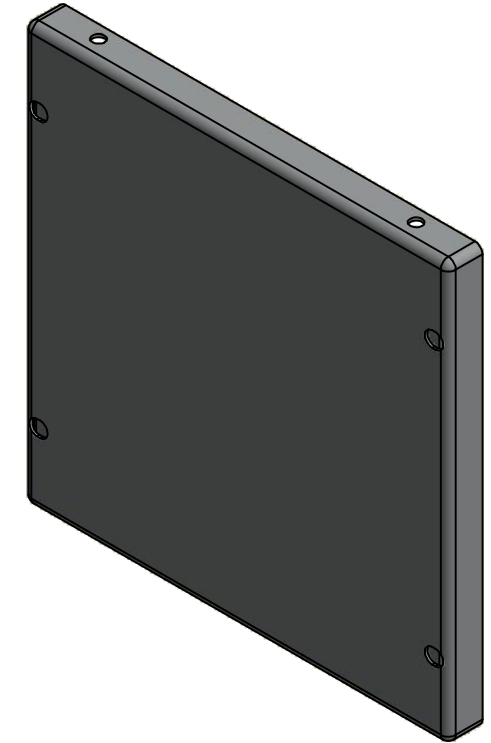

Isometric View

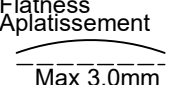
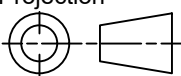

 Tél: (450) 979-4373 Fax: (450) 979-4626 www.exmweb.com		Flatness Aplatissement  Max 3.0mm
Projection 		Date
Customer Client	BoxCad: BoxCad	Date 6/13/2013
Drawn By / Dessiné Par	16 Ga Cold Rolled A1008 CS Type B (1.4mm)	
Material / Matière	Color / Couleur: Asa-61 Grey	Finish / Fini: Smooth
Description: 5412ESSC 8" x 8" Cover		Detail Rev.
Part Number / Numéro Pièce: 5412ESSC080804C	Rev. 0	9

Qty	Part Number	Rev	Description
1	STK-Q-08350	5	Standoff M6 x 10mm
1	STK-P-02400S	0	Powder Paint (Asa-61 Grey / Smooth)
1	5412ESSC080804G	0	5412ESSC 8" x 8" Gasket
1	STK-S-00100	0	3.5" x 2" Silver Milar Flexcon Sticker
1	5412ESSC080804C-P	0	5412ESSC 8" x 8" Cover Part
Parts List			

This drawing is confidential and must not be reproduced or used without the consent of EXM

Ce dessin est confidentiel et ne doit pas être reproduit ou utilisé sans le consentement de EXM

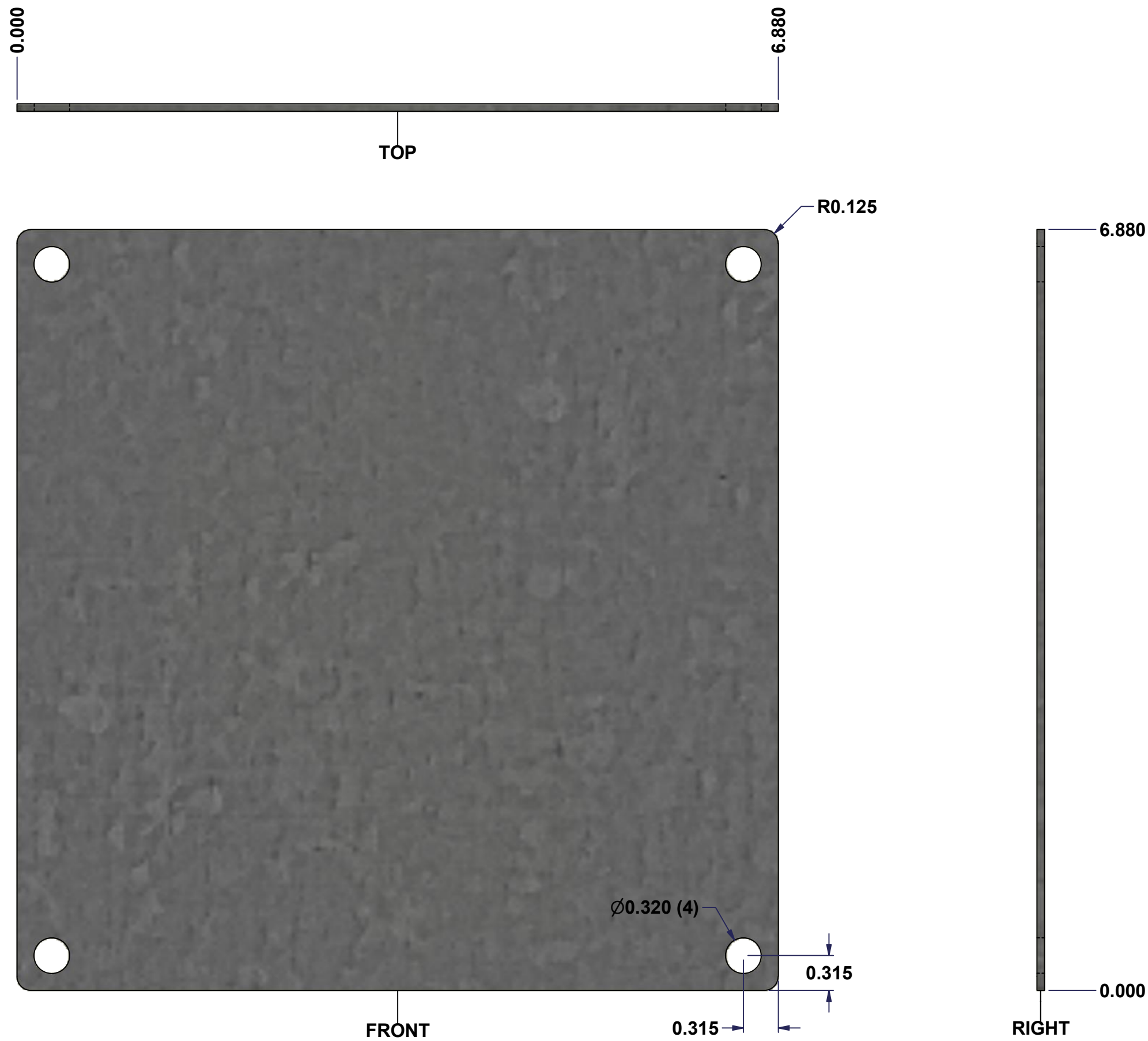

No.	Revisions	Date	By/Par



<p>Tél: (450) 979-4373 Fax: (450) 979-4626 www.exmweb.com</p>	Flatness Aplatissement	Max 3.0mm
	Projection	
Customer Client	Date	
Drawn By Dessiné Par	BoxCad	Date 23-Jan-07
Material Matière	14 Ga Galvanized (1.7mm)	
Color Couleur	Unpainted	Finish Fini Galvanized
Description	880 SP0808G - Inner Panel	
Part Number Numéro Pièce	Rev. 0	1 2

SEE BILL OF MATERIAL ON LAST PAGE

880 SP0808G

This drawing is confidential and must not be reproduced or used without the consent of EXM

Ce dessin est confidentiel et ne doit pas être reproduit ou utilisé sans le consentement de EXM

No.	Revisions	Date	By/Par

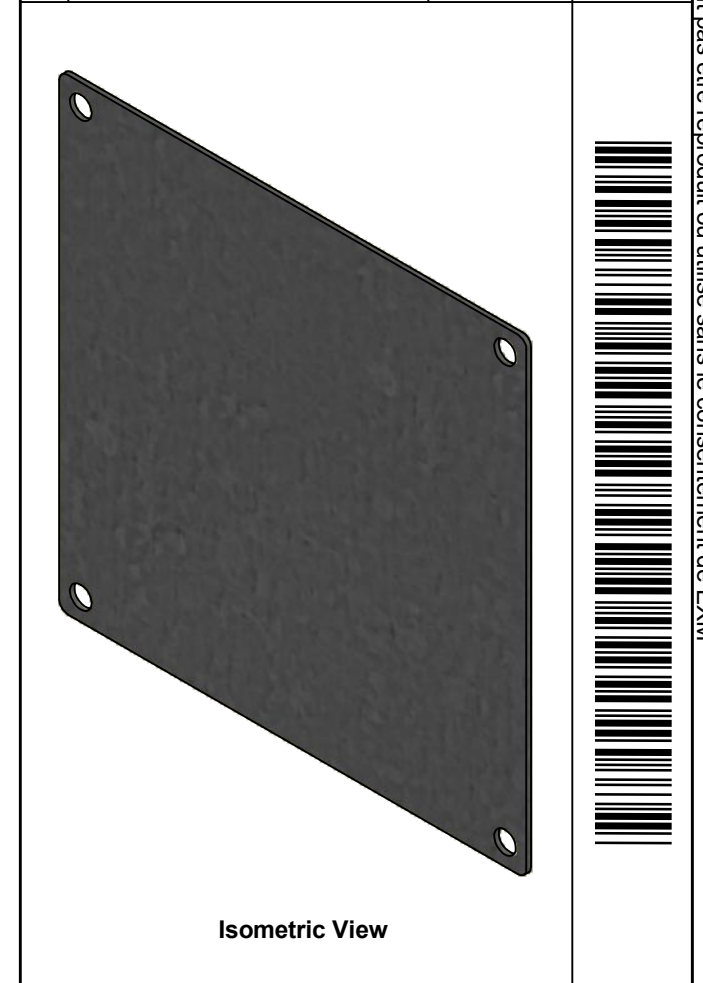

 Tél: (450) 979-4373 Fax: (450) 979-4626 www.exmweb.com		Flatness Aplatissement Max 3.0mm
Customer Client		Date
Drawn By / Dessiné Par: BoxCad		Date: 23-Jan-07
Material / Matière: 14 Ga Galvanized (1.7mm)		
Color / Couleur: Unpainted	Finish / Fini: Galvanized	
Description: 880 SP0808G - Inner Panel		Detail Rev.
Part Number / Numéro Pièce: 880 SP0808G		Rev. 0 / 2

Qty	Part Number	Rev	Description
1	880 SP0808G-P	0	880 SP0808G - Inner Panel Part
Parts List			