

This drawing is confidential and must not be reproduced or used without the consent of EXM

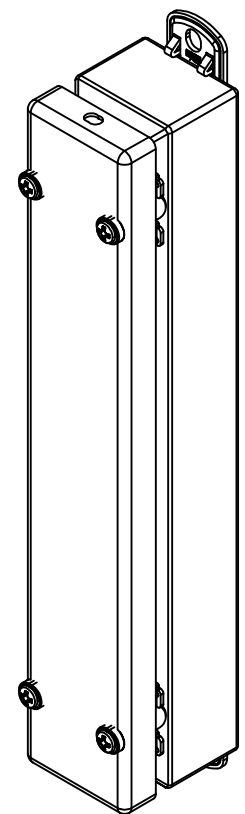

Isometric View

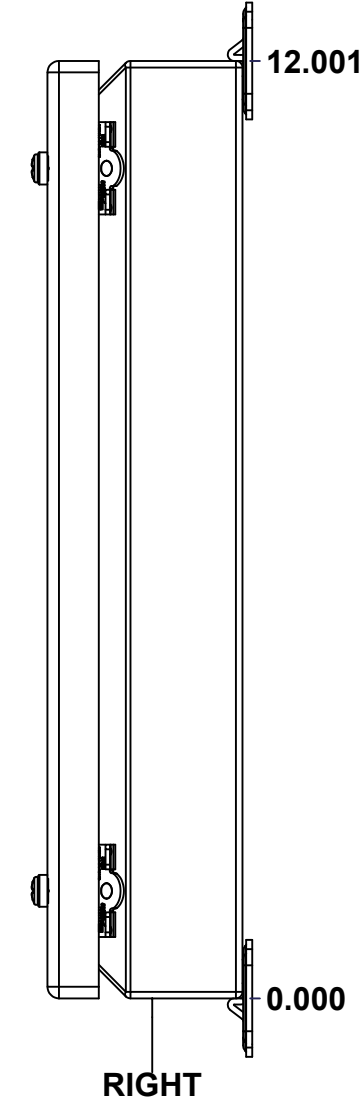
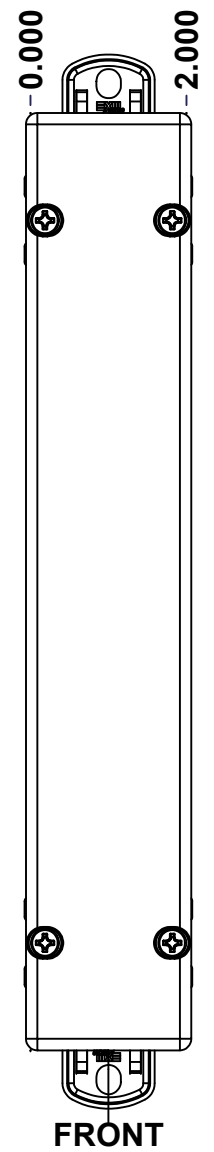
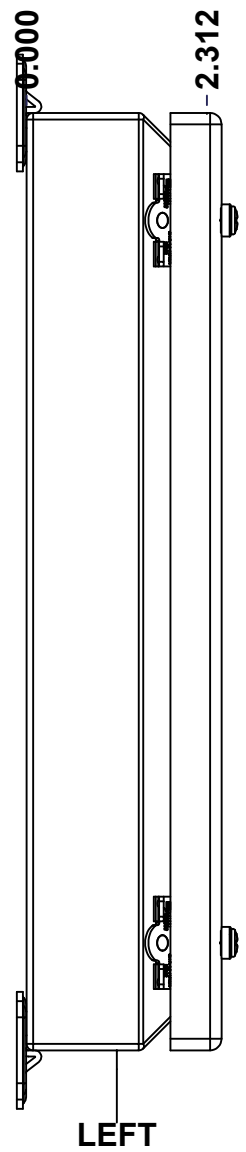
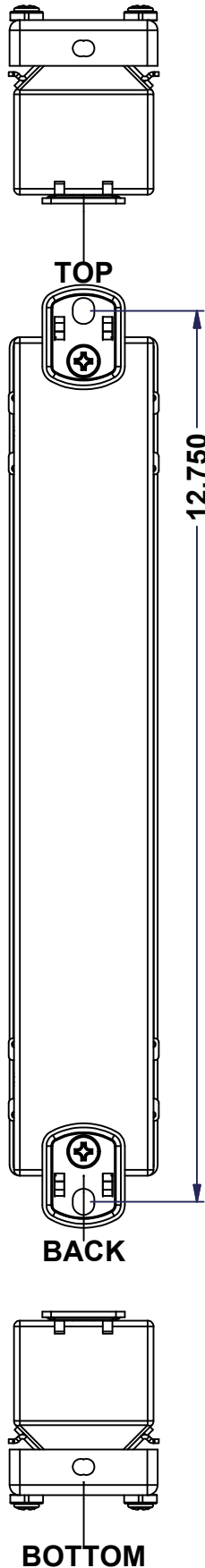
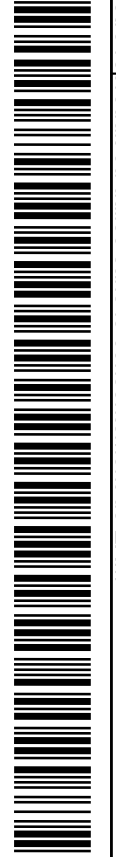

Ce dessin est confidentiel et ne doit pas être reproduit ou utilisé sans le consentement de EXM

No.	Revisions	Date	By/Par

		Tél: (450) 979-4373 Fax: (450) 979-4626 www.exmweb.com	Flatness Aplatissement Max 3.0mm Projection
Customer Client			Date
Drawn By Dessiné Par	BoxCad: BoxCad	Date 22-Oct-13	
Material Matière	16 Ga H.R.P. & O. (1.4mm)		
Color Couleur	Asa-61 Grey	Finish Fini	Smooth
Description	5412ESSC 12" x 2" x 2" Assembly		Detail Rev.
Part Number Numéro Pièce	5412ESSC120202	Rev.	1 0 2

SEE BILL OF MATERIAL ON LAST PAGE

This drawing is confidential and must not be reproduced or used without the consent of EXM

Ce dessin est confidentiel et ne doit pas être reproduit ou utilisé sans le consentement de EXM

NOTE	
ITEM	DESCRIPTION
1	NEMA 4/12 Enclosure
2	C/W Standard ground standoffs on box and cover
3	W/O Standard door stiffener
4	W/O Inner panel
5	W/O Inner panel mounting standoffs

No.	Revisions	Date	By/Par

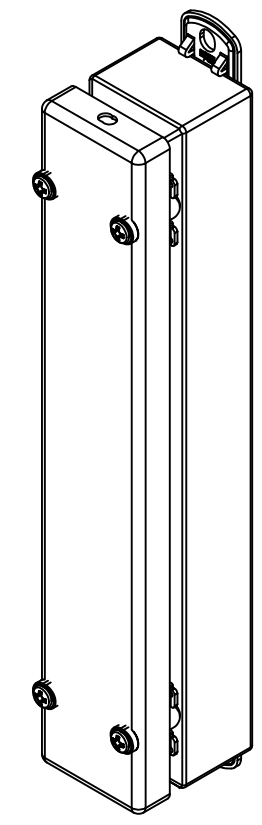

Isometric View

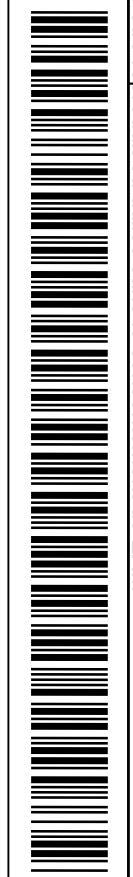

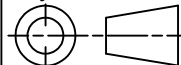
 Tél: (450) 979-4373 Fax: (450) 979-4626 www.exmweb.com	Flatness Aplatissement Max 3.0mm
	Projection 
Customer Client	Date
Drawn By Dessiné Par BoxCad: BoxCad	Date 22-Oct-13
Material Matière 16 Ga H.R.P. & O. (1.4mm)	
Color Couleur Asa-61 Grey	Finish Fini Smooth
Description 5412ESSC 12" x 2" x 2" Assembly	Detail Rev.
Part Number Numéro Pièce 5412ESSC120202	Rev. 0

PACKING		
ITEM	QTY	DESCRIPTION
Cardboard sleeve	2	Top and Bottom
Cardboard strip	2	Between back of enclosure and inner panel
Plastic bag	1	To protect cover surface and inside gasket
Packaging label	1	White label with product number

Qty	Part Number	Rev	Description
1	STK-K-02920	3	5412 ESSC Accessory Kit
1	5412ESSC120202C	0	5412ESSC 12" x 2" Cover
1	5412ESSC120202B	0	5412ESSC 12" x 2" x 2" Body
Parts List			

This drawing is confidential and must not be reproduced or used without the consent of EXM

Ce dessin est confidentiel et ne doit pas être reproduit ou utilisé sans le consentement de EXM

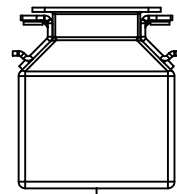

TOP

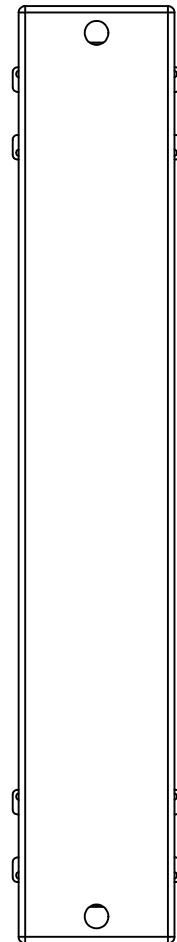

BACK

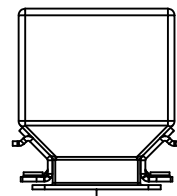

BOTTOM

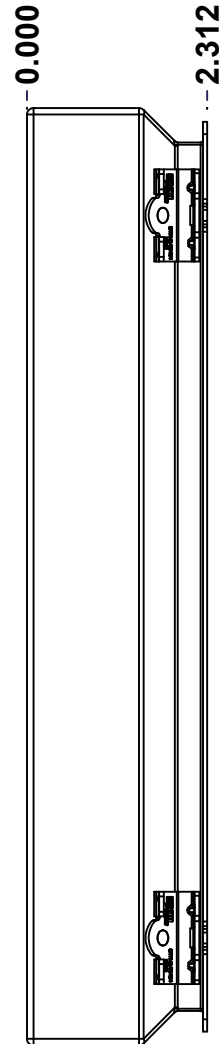

LEFT

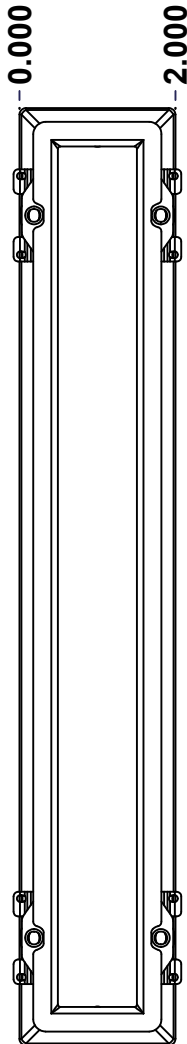

FRONT

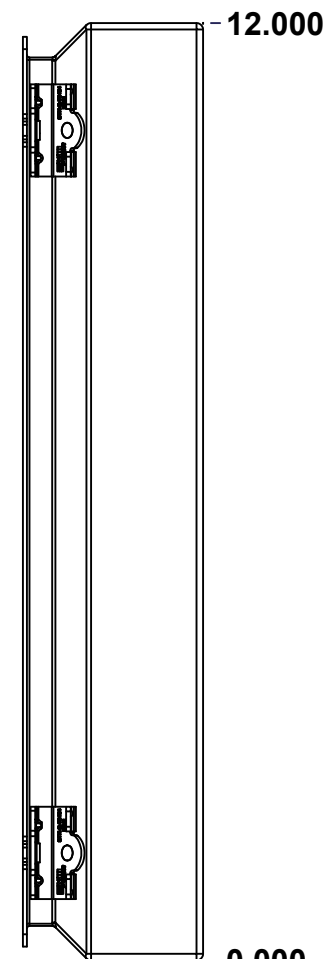

RIGHT

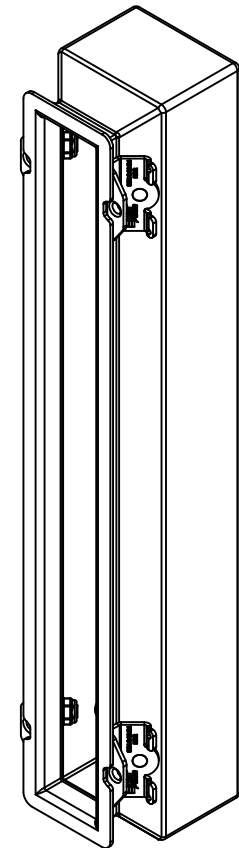

Isometric View

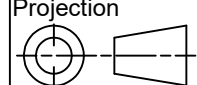

No.	Revisions	Date	By/Par

 Tél: (450) 979-4373 Fax: (450) 979-4626 www.exmweb.com		Flatness Aplatissement Max 3.0mm Projection 
Customer Client	Date	
Drawn By Dessiné Par	BoxCad: BoxCad	Date 22-Oct-13
Material Matière	16 Ga H.R.P. & O. (1.4mm)	
Color Couleur	Asa-61 Grey	Finish Fini Smooth
Description	Detail Rev.	
5412ESSC 12" x 2" x 2" Body		
Part Number Numéro Pièce	Rev.	1 7
5412ESSC120202B	0	

SEE BILL OF MATERIAL ON LAST PAGE

This drawing is confidential and must not be reproduced or used without the consent of EXM

Ce dessin est confidentiel et ne doit pas être reproduit ou utilisé sans le consentement de EXM

STANDARD FEATURES ARE NOT LISTED IN THIS HOLE TABLE			
HOLE TABLE - LEFT VIEW (CUSTOM FEATURE ONLY)			
CUT-OUT	XDIM	YDIM	DESCRIPTION
1	0.625	0.875	STANDOFF M6 x 10mm (Inside)

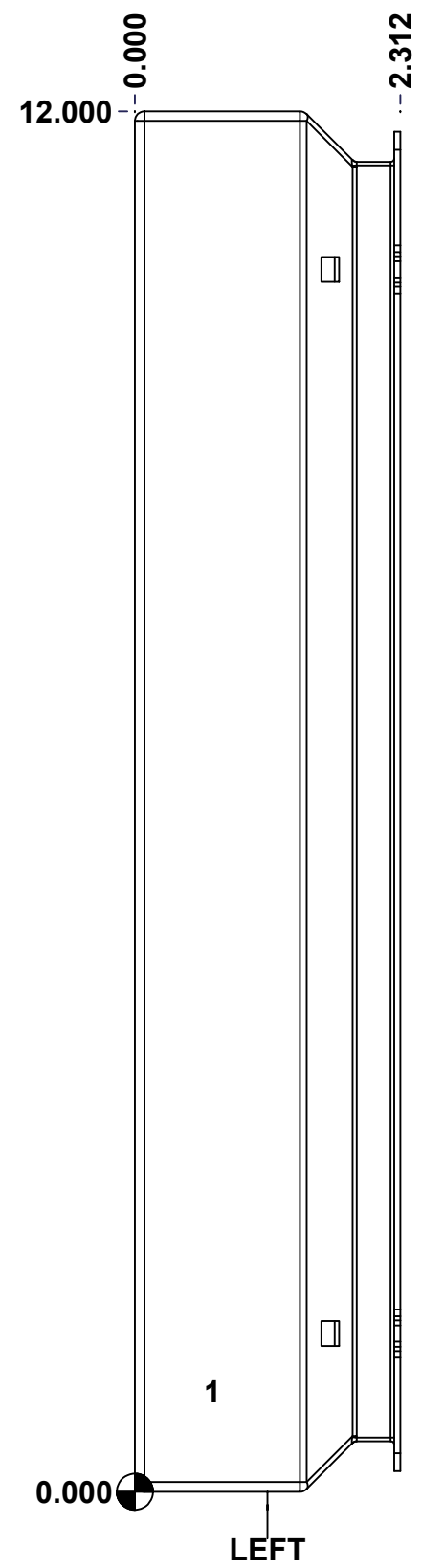

	Description	Status	
	5412ESSC 12" x 2" x 2" Body	(NULL)	
	Part Number Numéro Pièce	Rev.	
	5412ESSC120202B	0	5 7

This drawing is confidential and must not be reproduced or used without the consent of EXM

Ce dessin est confidentiel et ne doit pas être reproduit ou utilisé sans le consentement de EXM

No.	Revisions	Date	By/Par

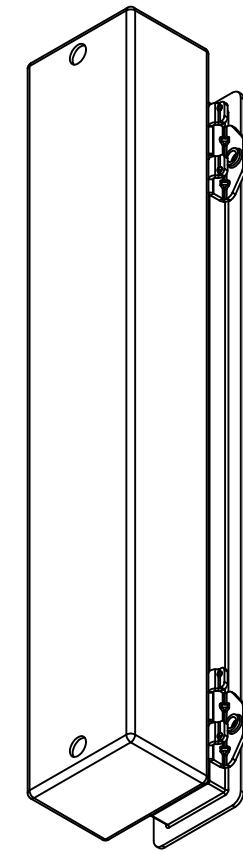

Isometric View

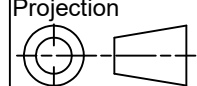

 Tél: (450) 979-4373 Fax: (450) 979-4626 www.exmweb.com		Flatness Aplatissement Max 3.0mm Projection 
Customer Client	Date	
Drawn By Dessiné Par	BoxCad: BoxCad	Date 22-Oct-13
Material Matière	16 Ga H.R.P. & O. (1.4mm)	
Color Couleur	Asa-61 Grey	Finish Fini Smooth
Description		Detail Rev.
5412ESSC 12" x 2" x 2" Body		
Part Number Numéro Pièce	Rev.	7
5412ESSC120202B	0	7

Qty	Part Number	Rev	Description
1	STK-Q-08350	5	Standoff M6 x 10mm
1	STK-P-02400S	0	Powder Paint (Asa-61 Grey / Smooth)
1	5412ESSC120202B-P	0	5412ESSC 12" x 2" x 2" Body Part
4	STK-Q-08100	1	M5 Nylon Insert Lock Nut
4	STK-Q-70464	2	5412 ESSC & ESSSC Stainless Steel Body Catch Assembly
Parts List			

This drawing is confidential and must not be reproduced or used without the consent of EXM

Ce dessin est confidentiel et ne doit pas être reproduit ou utilisé sans le consentement de EXM



TOP

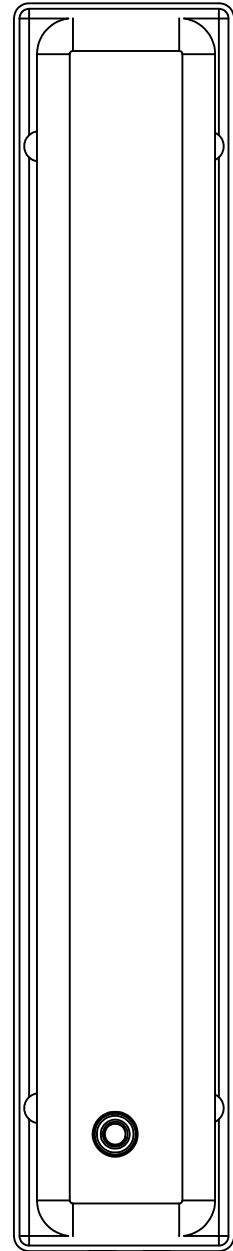

BACK

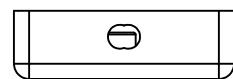

BOTTOM

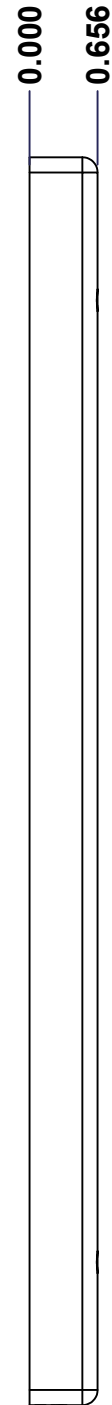

LEFT

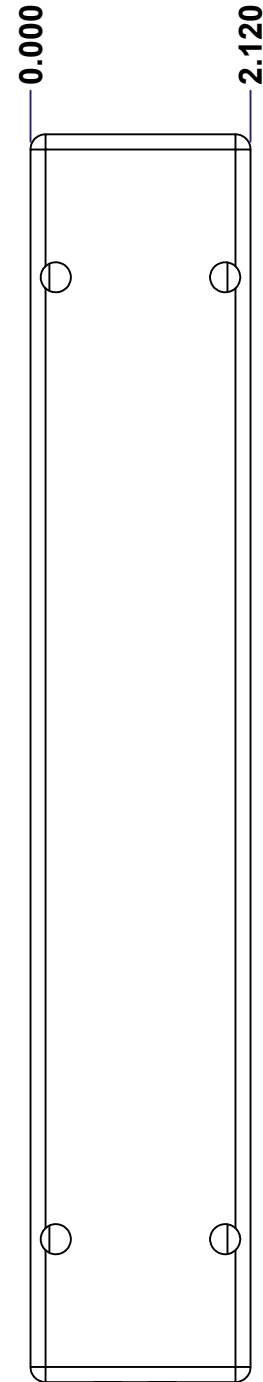

FRONT

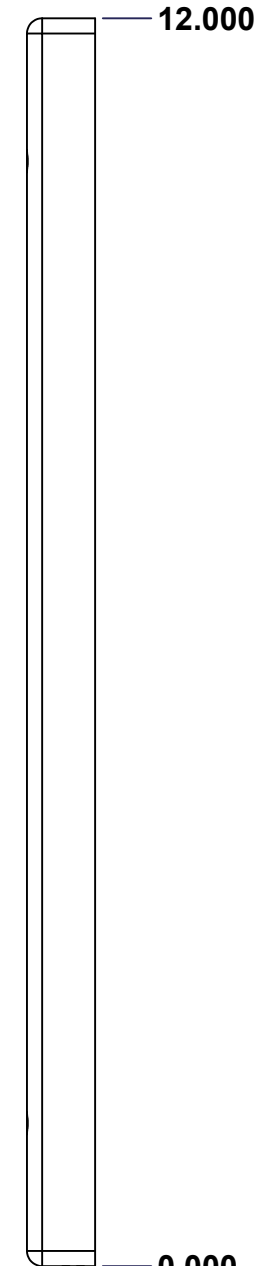

RIGHT

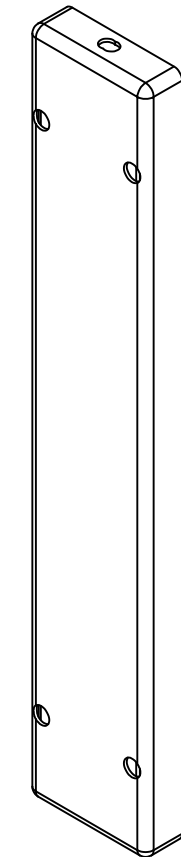

Isometric View

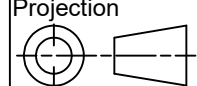

No.	Revisions	Date	By/Par

 Tél: (450) 979-4373 Fax: (450) 979-4626 www.exmweb.com		Flatness Aplatissement Max 3.0mm Projection 
Customer Client	Date	Date
Drawn By Dessiné Par	BoxCad: BoxCad	22-Oct-13
Material Matière 16 Ga H.R.P. & O. (1.4mm)		
Color Couleur	Asa-61 Grey	Finish Fini Smooth
Description 5412ESSC 12" x 2" Cover		Detail Rev.
Part Number Numéro Pièce	Rev. 0	1 / 3

SEE BILL OF MATERIAL ON LAST PAGE

5412ESSC120202C

This drawing is confidential and must not be reproduced or used without the consent of EXM

Ce dessin est confidentiel et ne doit pas être reproduit ou utilisé sans le consentement de EXM

STANDARD FEATURES ARE NOT LISTED IN THIS HOLE TABLE			
HOLE TABLE - FRONT VIEW (CUSTOM FEATURE ONLY)			
CUT-OUT	XDIM	YDIM	DESCRIPTION
1	1.145	1.125	STANDOFF M6 x 10mm (Inside)

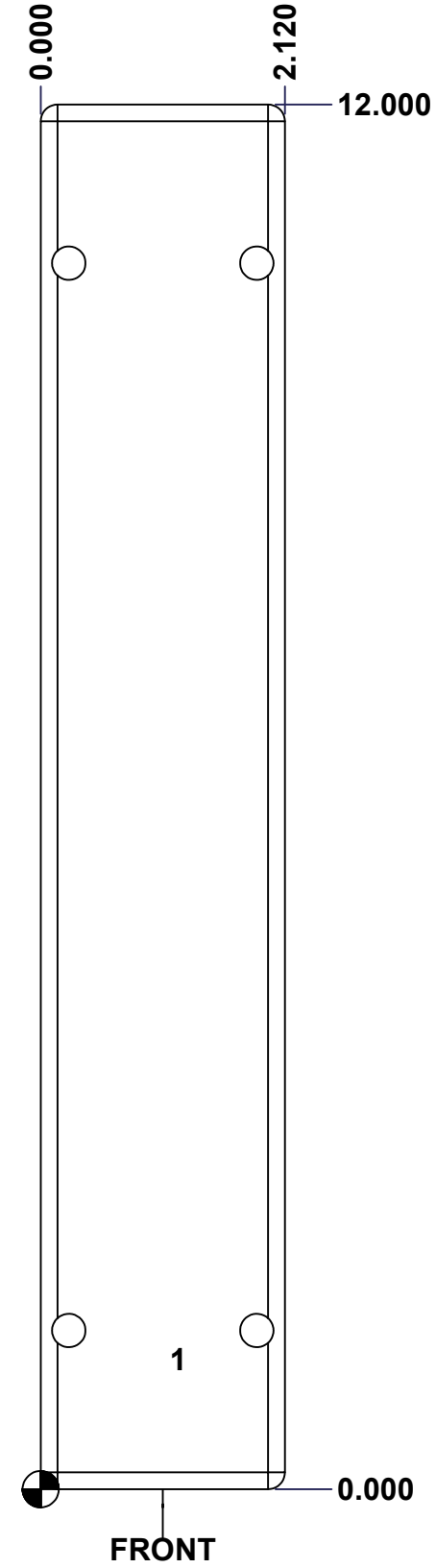

	Description		Status
	5412ESSC 12" x 2" Cover		(NULL)
	Part Number Numéro Pièce		Rev.
5412ESSC120202C		0	2 3

This drawing is confidential and must not be reproduced or used without the consent of EXM

Ce dessin est confidentiel et ne doit pas être reproduit ou utilisé sans le consentement de EXM

No.	Revisions	Date	By/Par

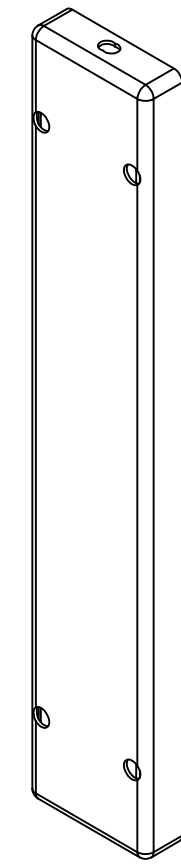

Isometric View

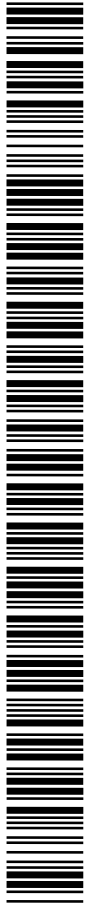

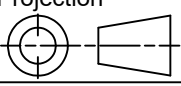
 Tél: (450) 979-4373 Fax: (450) 979-4626 www.exmweb.com		Flatness Aplatissement Max 3.0mm Projection 
Customer Client	Date	
Drawn By Dessiné Par	BoxCad: BoxCad	Date 22-Oct-13
Material Matière	16 Ga H.R.P. & O. (1.4mm)	
Color Couleur	Asa-61 Grey	Finish Fini Smooth
Description	Detail Rev.	
5412ESSC 12" x 2" Cover		
Part Number Numéro Pièce	Rev.	3
5412ESSC120202C	0	3

Qty	Part Number	Rev	Description
1	STK-Q-08350	5	Standoff M6 x 10mm
1	STK-P-02400S	0	Powder Paint (Asa-61 Grey / Smooth)
1	5412ESSC120202G	0	5412ESSC 12" x 2" Gasket
1	5412ESSC120202C-P	0	5412ESSC 12" x 2" Cover Part
Parts List			