

This drawing is confidential and must not be reproduced or used without the consent of EXM

Ce dessin est confidentiel et ne doit pas être reproduit ou utilisé sans le consentement de EXM

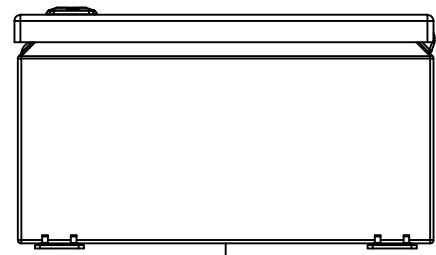

TOP

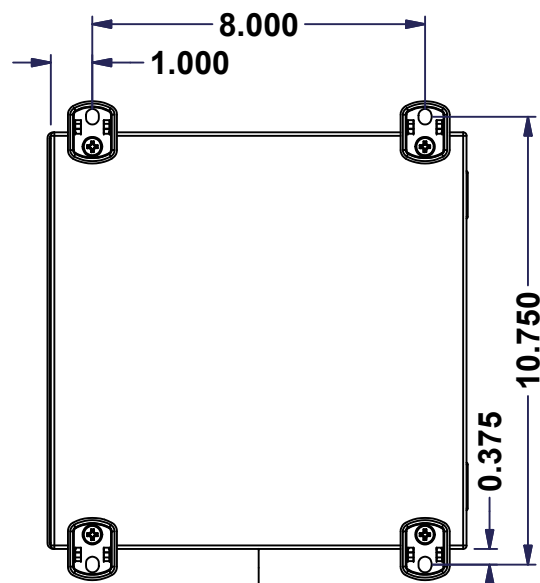

BACK

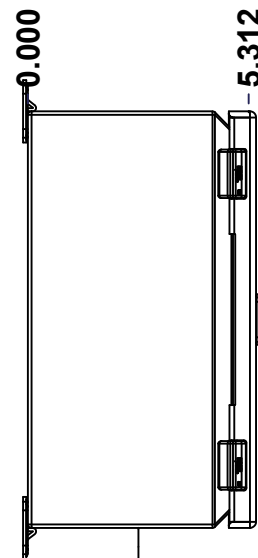

LEFT

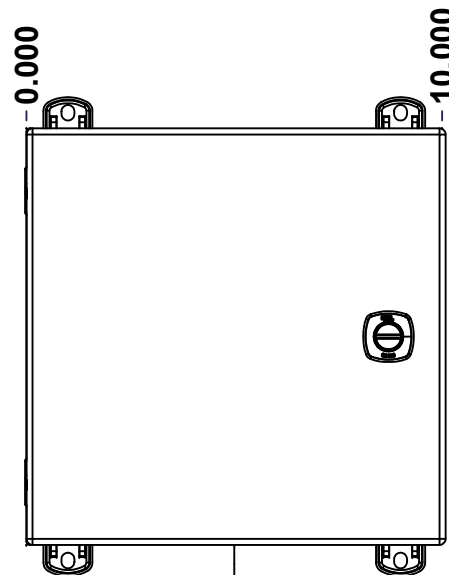

FRONT

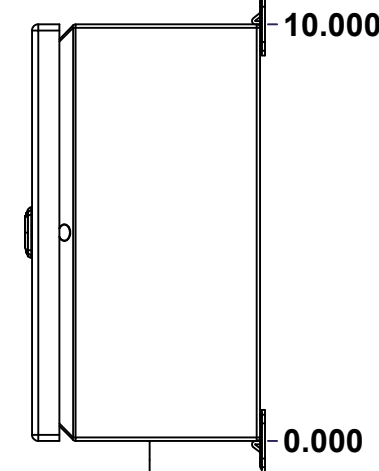

RIGHT

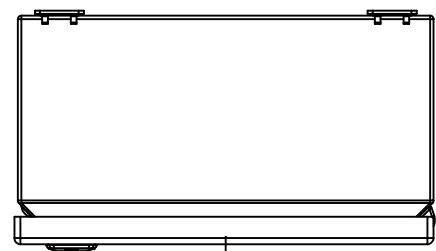

BOTTOM

No.	Revisions	Date	By/Par

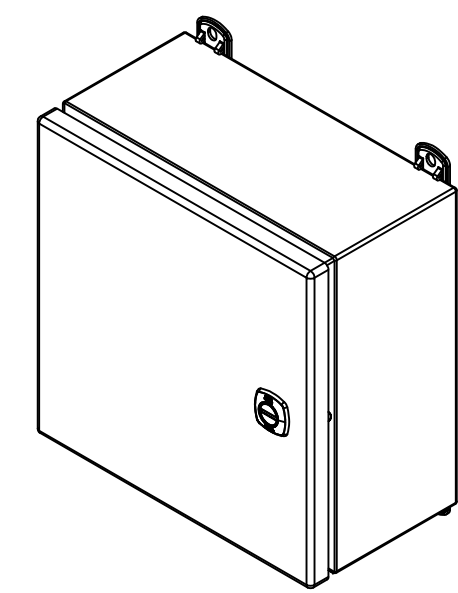

Isometric View

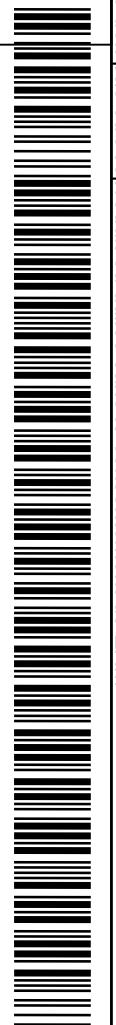

**GRAIN DIRECTION:
TOP/BOTTOM: HORIZONTAL
LEFT/RIGHT/BACK/FRONT: VERTICAL**

SEE BILL OF MATERIAL ON LAST PAGE

Tél: (450) 979-4373 Fax: (450) 979-4626 www.exmweb.com		Flatness Aplatissement Max 3.0mm Projection
Customer Client	Date	Date
Drawn By Dessiné Par	BoxCad: BoxCad	Date 10-Nov-21
Material Matière	16 Ga Stainless Steel 316 (1.4mm)	
Color Couleur	Unpainted	Finish Fini Brushed
Description	Detail Rev.	
5412ESSM 10" x 10" x 5" Assembly		
Part Number Numéro Pièce	Rev.	1
5412ESSM1010056NOIP	0	2

This drawing is confidential and must not be reproduced or used without the consent of EXM

Ce dessin est confidentiel et ne doit pas être reproduit ou utilisé sans le consentement de EXM

NOTE	
ITEM	DESCRIPTION
1	NEMA 4X Enclosure
2	C/W Standard ground standoffs on box and cover
3	W/O Standard door stiffener
4	W/O Inner panel
5	C/W Standard inner panel mounting standoffs
6	C/W 885 ESCHMF2 Mounting Feet (Installed)

No.	Revisions	Date	By/Par

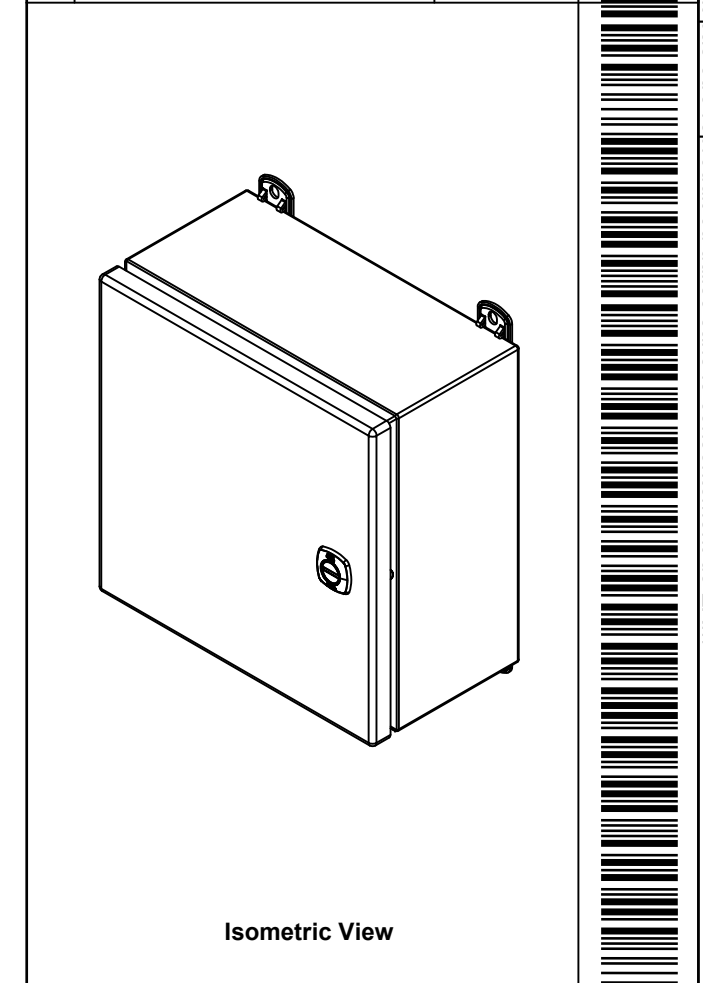

		Tél: (450) 979-4373 Fax: (450) 979-4626 www.exmweb.com	Flatness Aplatissement Max 3.0mm Projection
Customer Client	Date		Date 10-Nov-21
Drawn By Dessiné Par	BoxCad: BoxCad		Date 10-Nov-21
Material Matière	16 Ga Stainless Steel 316 (1.4mm)		
Color Couleur	Unpainted	Finish Fini	Brushed
Description	5412ESSM 10" x 10" x 5" Assembly		Detail Rev.
Part Number Numéro Pièce	5412ESSM1010056NOIP		Rev. 0

Qty	Part Number	Rev	Description
1	5412ESSM1010056NOIP C	0	5412ESSM 10" x 10" Cover
1	STK-K-02910	3	5412 ESCH Accessory Kit
1	885 ESSCHMFQ	0	5412 ESSCH Mounting Feet Accessory Kit
1	5412ESSM1010056NOIP B	0	5412ESSM 10" x 10" x 5" Body
2	STK-Q-08100	1	M5 Nylon Insert Lock Nut
Parts List			

PACKING		
ITEM	QTY	DESCRIPTION
STK-E-04312	1	CARTON 5412 ESCH101005
Plastic bag	1	To protect cover surface and inside gasket
Packaging label	1	White label with product number
STK-S-01100	1	ESCH EXM SQUARE STICKER

This drawing is confidential and must not be reproduced or used without the consent of EXM

Ce dessin est confidentiel et ne doit pas être reproduit ou utilisé sans le consentement de EXM

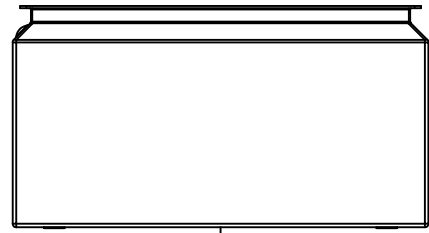

TOP

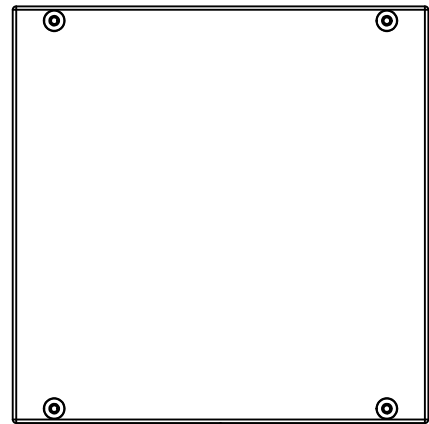

BACK

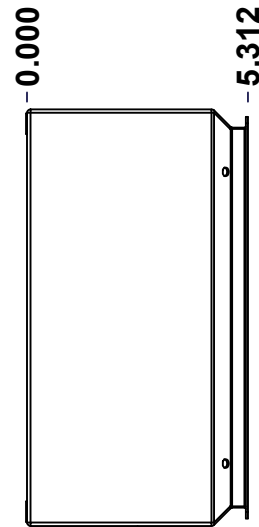

LEFT

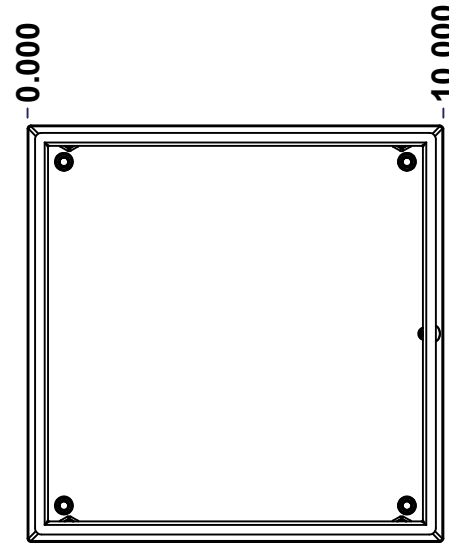

FRONT

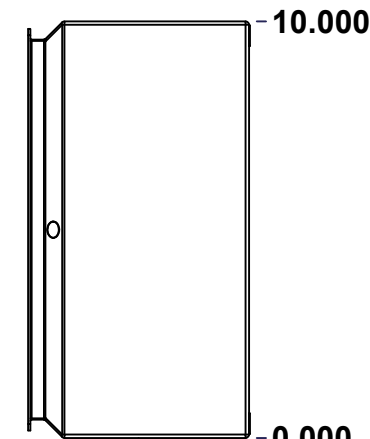

RIGHT

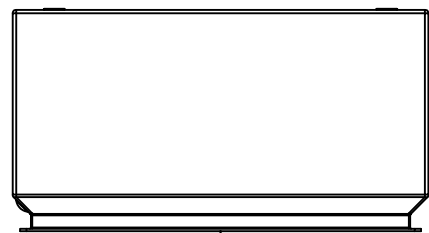

BOTTOM

No.	Revisions	Date	By/Par

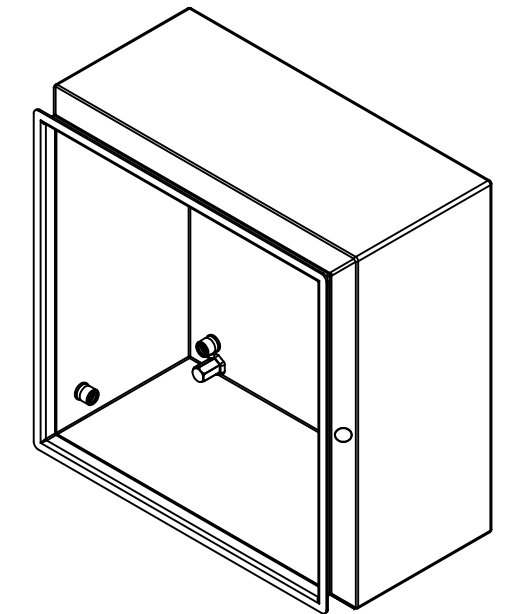

Isometric View



Tél: (450) 979-4373
 Fax: (450) 979-4626
www.exmweb.com

Flatness
Aplatissement
Max 3.0mm
Projection

Customer Client	Date
Drawn By / Dessiné Par: BoxCad: BoxCad	Date: 10-Nov-21
Material / Matière: 16 Ga Stainless Steel 316 (1.4mm)	
Color / Couleur: Unpainted	Finish / Fini: Brushed
Description: 5412ESSM 10" x 10" x 5" Body	
Part Number / Numéro Pièce: 5412ESSM1010056NOIPB	Rev. 0

SEE BILL OF MATERIAL ON LAST PAGE

Rev. 1
7

This drawing is confidential and must not be reproduced or used without the consent of EXM

Ce dessin est confidentiel et ne doit pas être reproduit ou utilisé sans le consentement de EXM

STANDARD FEATURES ARE NOT LISTED IN THIS HOLE TABLE			
HOLE TABLE - LEFT VIEW (CUSTOM FEATURE ONLY)			
CUT-OUT	XDIM	YDIM	DESCRIPTION
1	3.625	0.875	STANDOFF M6 x 10mm (Inside)

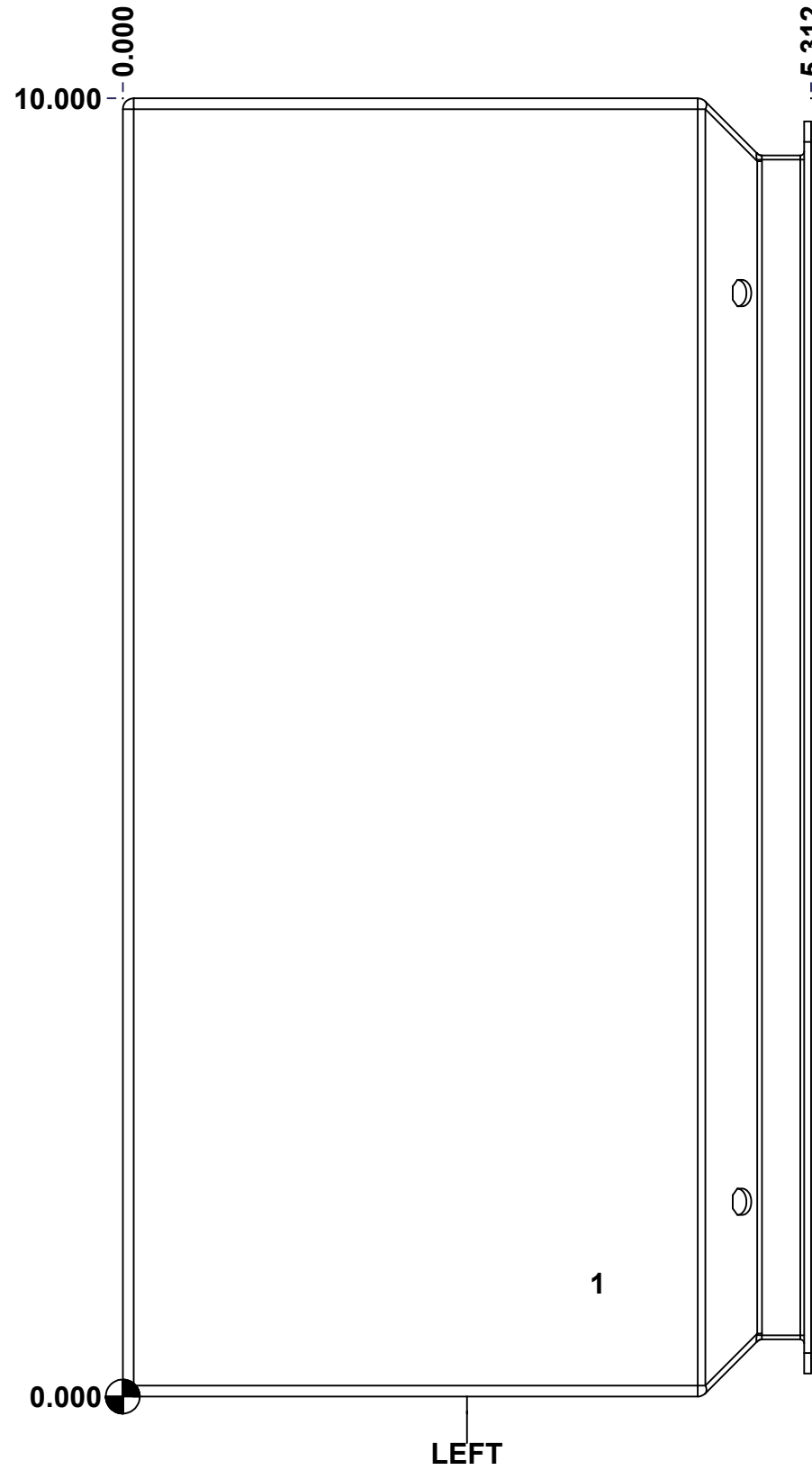

	Description		Status	
	5412ESSM 10" x 10" x 5" Body		(NULL)	
Part Number Numéro Pièce		Rev.	5	7
5412ESSM1010056NOIPB		0		

This drawing is confidential and must not be reproduced or used without the consent of EXM

Ce dessin est confidentiel et ne doit pas être reproduit ou utilisé sans le consentement de EXM

STANDARD FEATURES ARE NOT LISTED IN THIS HOLE TABLE

HOLE TABLE - BACK VIEW (CUSTOM FEATURE ONLY)

CUT-OUT	XDIM	YDIM	DESCRIPTION
1	0.875	0.875	IP STANDOFF M6 x 10mm (Inside)
2	0.875	9.125	IP STANDOFF M6 x 10mm (Inside)
3	9.125	9.125	IP STANDOFF M6 x 10mm (Inside)
4	9.125	0.875	IP STANDOFF M6 x 10mm (Inside)

5	1.000	10.000	FOOT 885 ESCHMF2
6	9.000	0.000	FOOT 885 ESCHMF2
7	1.000	0.000	FOOT 885 ESCHMF2
8	9.000	10.000	FOOT 885 ESCHMF2
9	1.000	9.656	RIVET NUT M6_FH_CE (Inside)
10	9.000	0.344	RIVET NUT M6_FH_CE (Inside)
11	1.000	0.344	RIVET NUT M6_FH_CE (Inside)
12	9.000	9.656	RIVET NUT M6_FH_CE (Inside)

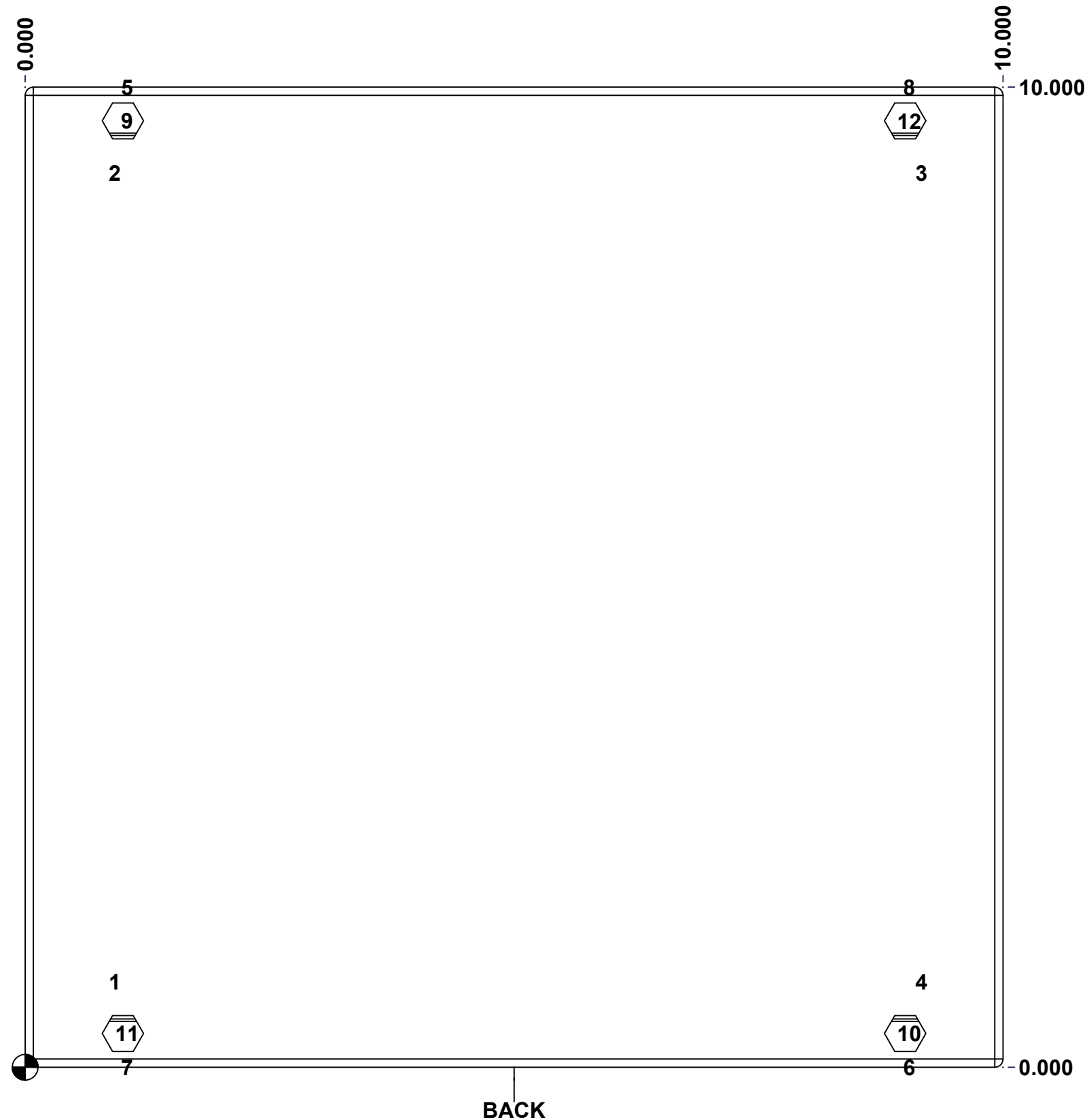



	Description	Status
	5412ESSM 10" x 10" x 5" Body	(NULL)
	Part Number Numéro Pièce	Rev.
	5412ESSM1010056NOIPB	0
		6
		7

This drawing is confidential and must not be reproduced or used without the consent of EXM

Ce dessin est confidentiel et ne doit pas être reproduit ou utilisé sans le consentement de EXM

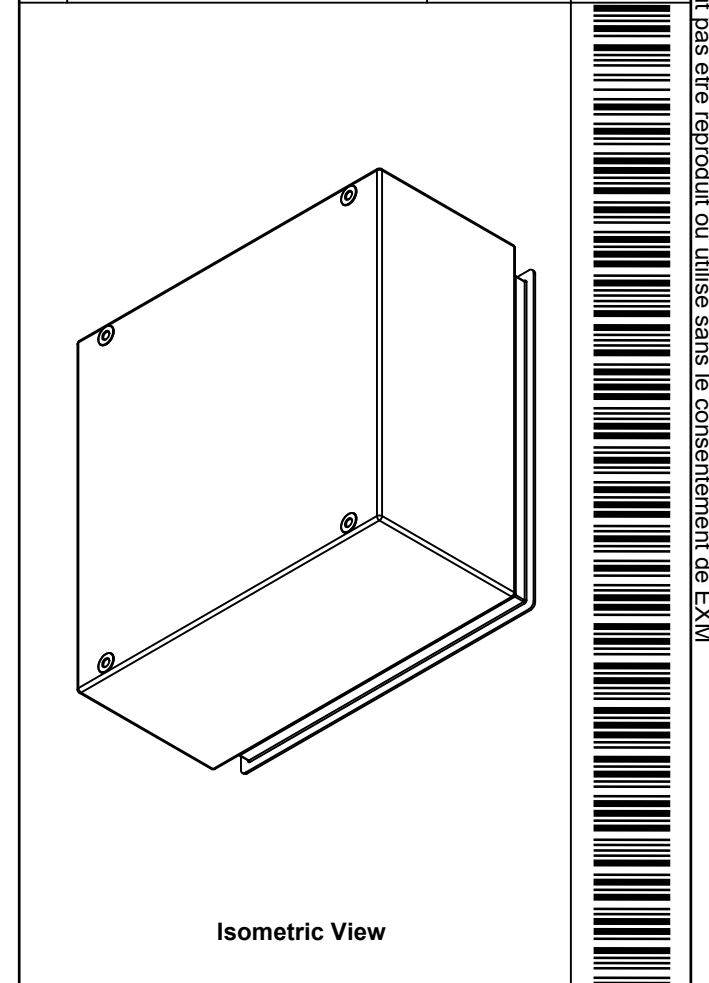
No.	Revisions	Date	By/Par

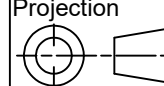

 Tél: (450) 979-4373 Fax: (450) 979-4626 www.exmweb.com		Flatness Aplatissement  Max 3.0mm
Customer Client		Date
Drawn By Dessiné Par BoxCad: BoxCad		Date 10-Nov-21
Material Matière 16 Ga Stainless Steel 316 (1.4mm)		Projection 
Color Couleur Unpainted		Finish Fini Brushed
Description 5412ESSM 10" x 10" x 5" Body		Detail Rev.
Part Number Numéro Pièce 5412ESSM1010056NOIPB		Rev. 0

Qty	Part Number	Rev	Description
4	RIVET_NUT_SS_M6_FH_CE	0	Stainless Steel Rivet Nut M6 (Low Profile Close End)
1	STK-Q-08112	3	M5 Stainless Steel 304 Nylon Insert Dome Nut
1	5412ESSM1010056NOIP B-P	0	5412ESSM 10" x 10" x 5" Body Part
1	STK-Q-00200	0	M5 x 8mm Stainless Steel 316 Carriage Bolt with Nyseal
5	STK-Q-08500	4	Stainless Steel Standoff M6 x 10mm
Parts List			

This drawing is confidential and must not be reproduced or used without the consent of EXM

Ce dessin est confidentiel et ne doit pas être reproduit ou utilisé sans le consentement de EXM

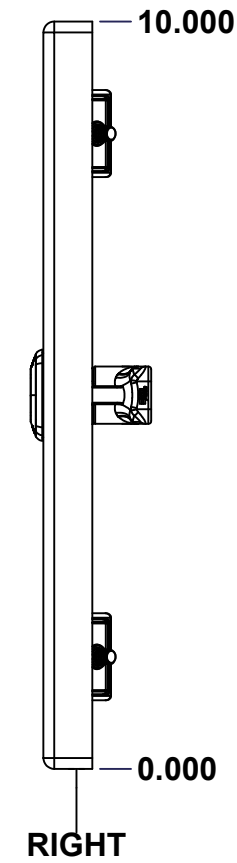
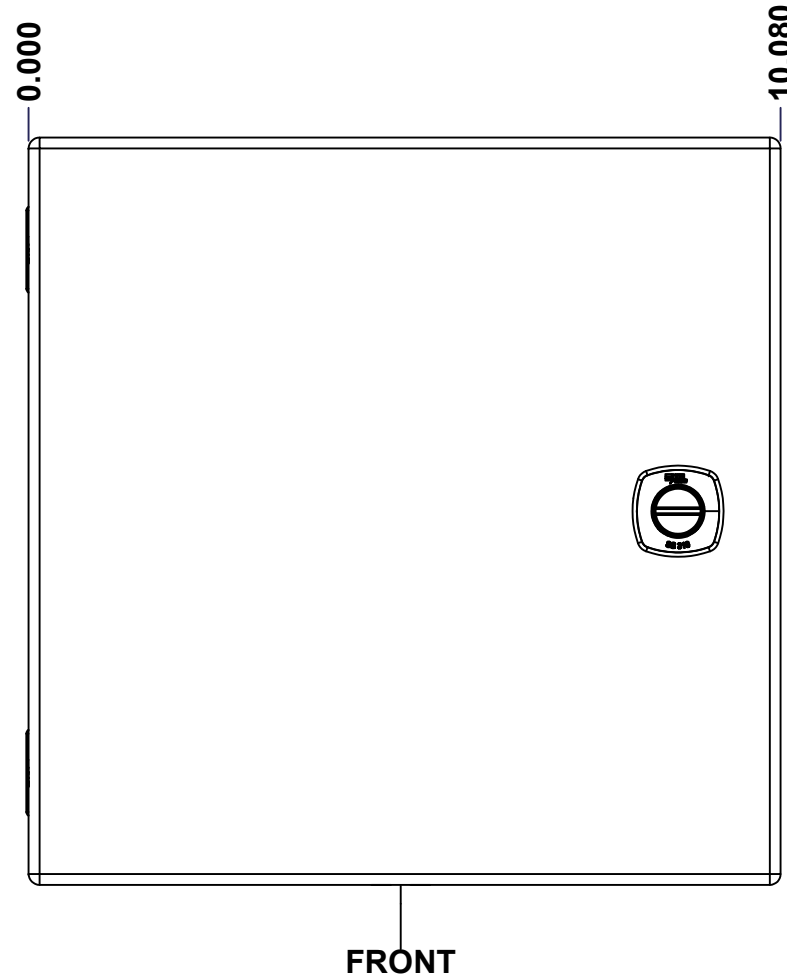
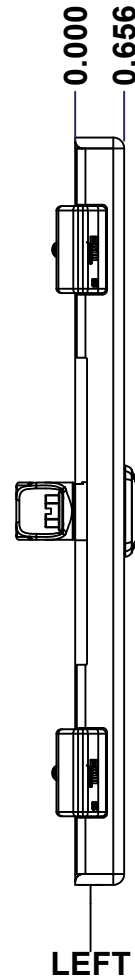
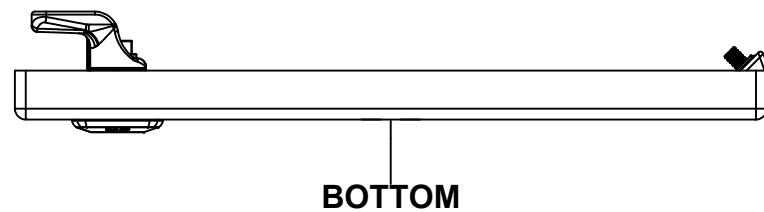
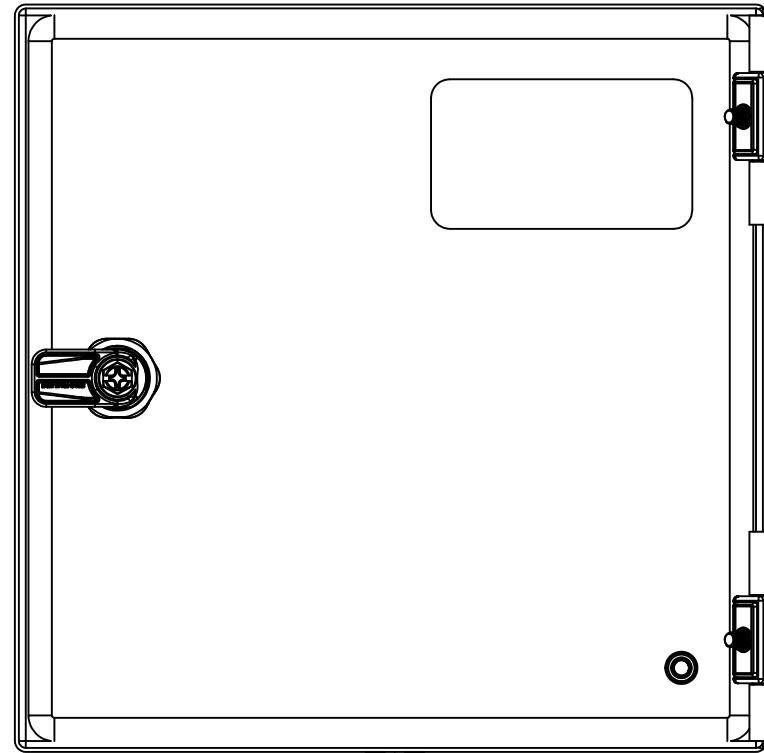
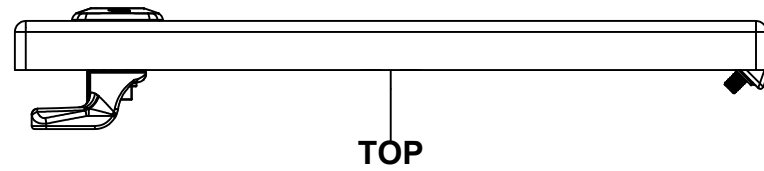

No.	Revisions	Date	By/Par

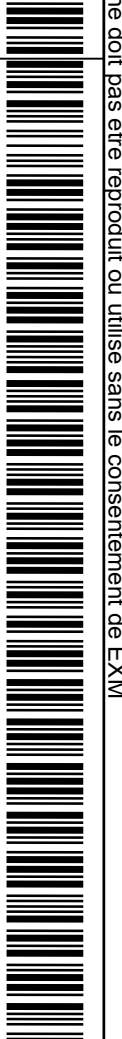
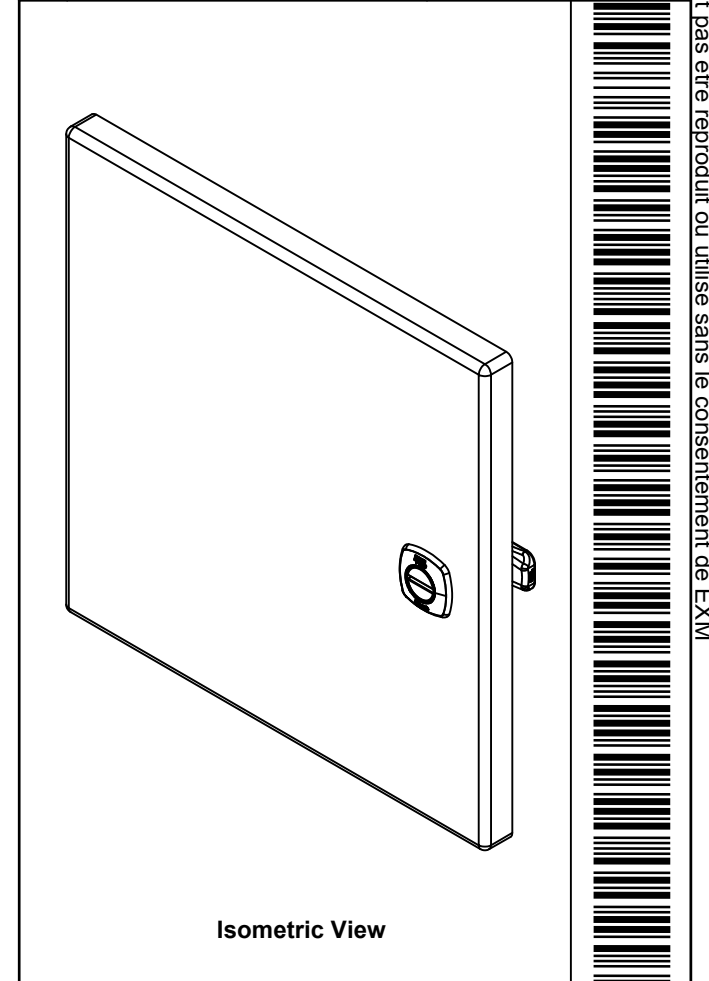

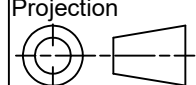
 Tél: (450) 979-4373 Fax: (450) 979-4626 www.exmweb.com		Flatness Aplatissement Max 3.0mm Projection 
Customer Client	Date	
Drawn By Dessiné Par	BoxCad: BoxCad	Date 10-Nov-21
Material Matière	16 Ga Stainless Steel 316 (1.4mm)	
Color Couleur	Unpainted	Finish Fini Brushed
Description	Detail Rev.	
5412ESSM 10" x 10" Cover		
Part Number Numéro Pièce	Rev. 0	1 / 3
5412ESSM1010056NOIPC		

SEE BILL OF MATERIAL ON LAST PAGE

This drawing is confidential and must not be reproduced or used without the consent of EXM

Ce dessin est confidentiel et ne doit pas être reproduit ou utilisé sans le consentement de EXM

STANDARD FEATURES ARE NOT LISTED IN THIS HOLE TABLE			
HOLE TABLE - FRONT VIEW (CUSTOM FEATURE ONLY)			
CUT-OUT	XDIM	YDIM	DESCRIPTION
1	1.145	1.125	STANDOFF M6 x 10mm (Inside)
2	2.750	8.000	LABEL_EXM
3	8.705	5.000	LOCK 880 SCQ4-SLSS6 @ 0.0°

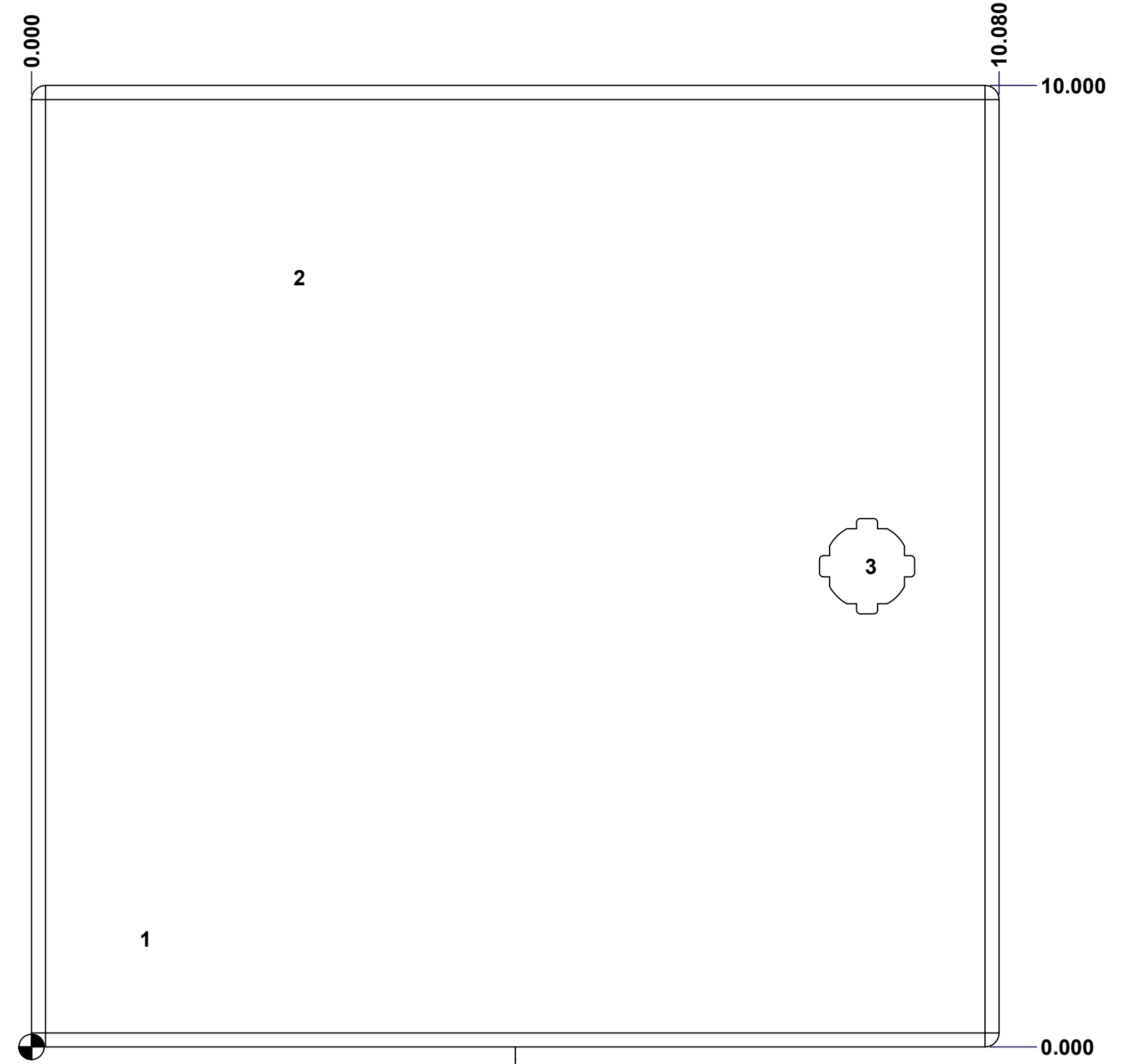

	Description	Status
	5412ESSM 10" x 10" Cover	(NULL)
	Part Number Numéro Pièce	Rev.
	5412ESSM1010056NOIPC	0
		2
		3

This drawing is confidential and must not be reproduced or used without the consent of EXM

Ce dessin est confidentiel et ne doit pas être reproduit ou utilisé sans le consentement de EXM

No.	Revisions	Date	By/Par

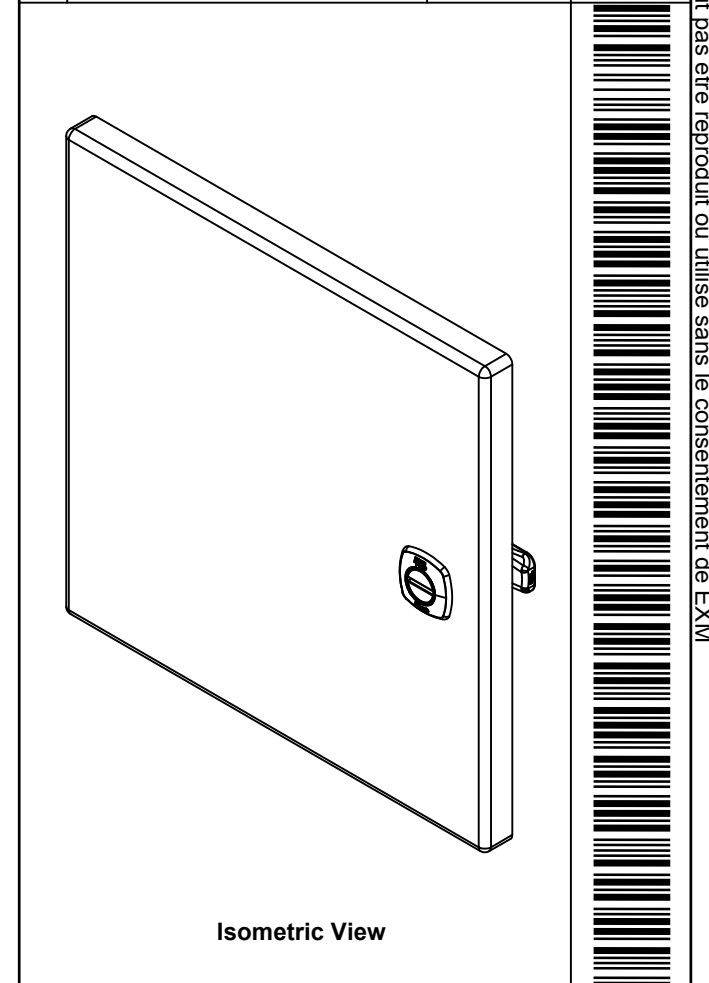

Tél: (450) 979-4373 Fax: (450) 979-4626 www.exmweb.com		Flatness Aplatissement Max 3.0mm Projection
Customer Client	Date	
Drawn By Dessiné Par	BoxCad: BoxCad	Date 10-Nov-21
Material Matière	16 Ga Stainless Steel 316 (1.4mm)	
Color Couleur	Unpainted	Finish Fini Brushed
Description	Detail Rev.	
5412ESSM 10" x 10" Cover		
Part Number Numéro Pièce	Rev. 0	3
5412ESSM1010056NOIPC		3

Qty	Part Number	Rev	Description
1	5412ESSM1010056NOIP G	0	5412ESSM 10" x 10" Gasket
1	880 SCQ4-SLSS6	7	5412 ESS 1/4 Turn Lock
1	STK-S-00100	0	3.5" x 2" Silver Milar Flexcon Sticker
1	STK-Q-08500	4	Stainless Steel Standoff M6 x 10mm
1	5412ESSM1010056NOIP C-P	0	5412ESSM 10" x 10" Cover Part
2	STK-A-33038	3	5412 ESSMCH - Stainless Steel Hinge
Parts List			