

This drawing is confidential and must not be reproduced or used without the consent of EXM

Ce dessin est confidentiel et ne doit pas être reproduit ou utilisé sans le consentement de EXM

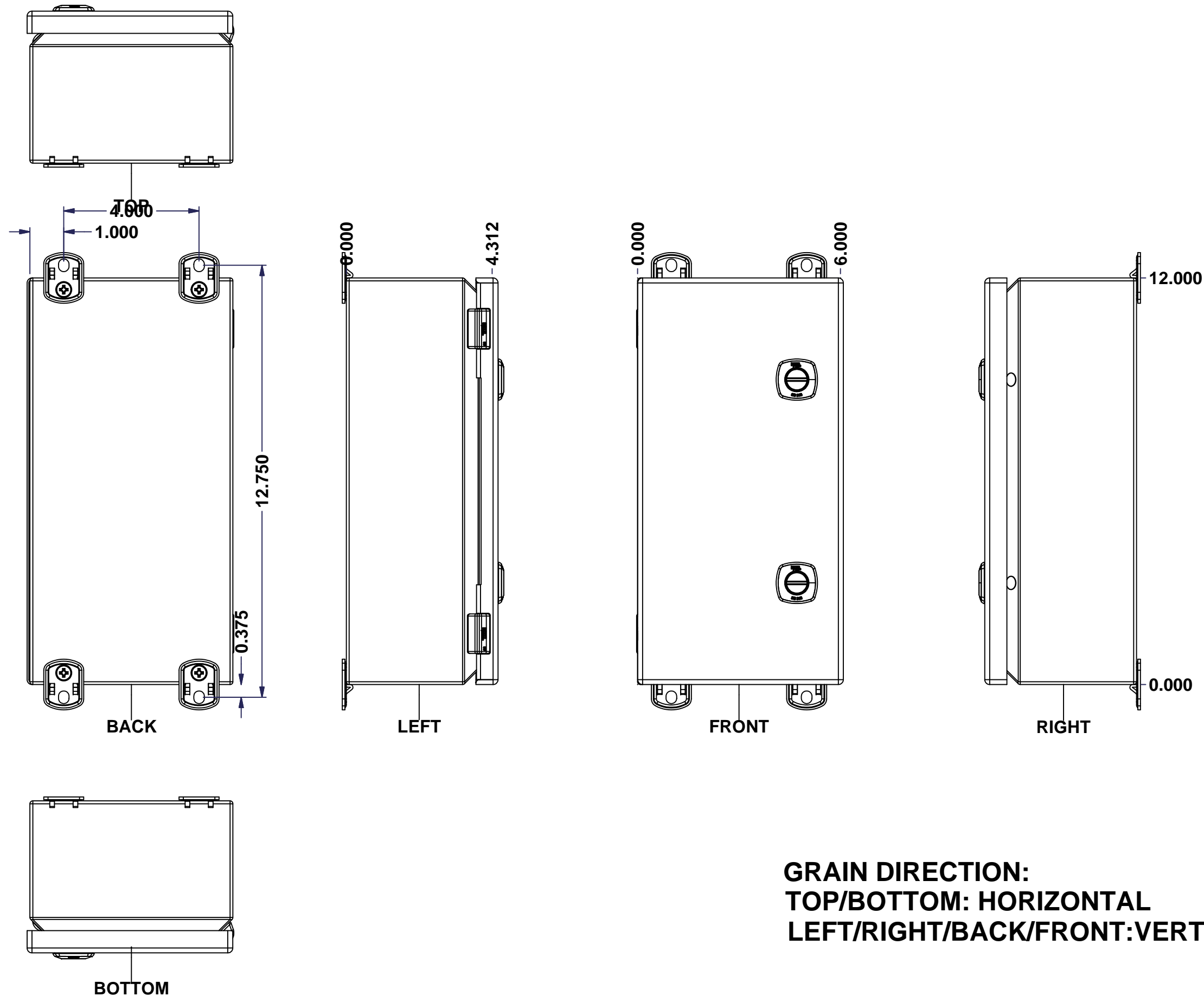

**GRAIN DIRECTION:
TOP/BOTTOM: HORIZONTAL
LEFT/RIGHT/BACK/Front: VERTICAL**

No.	Revisions	Date	By/Par

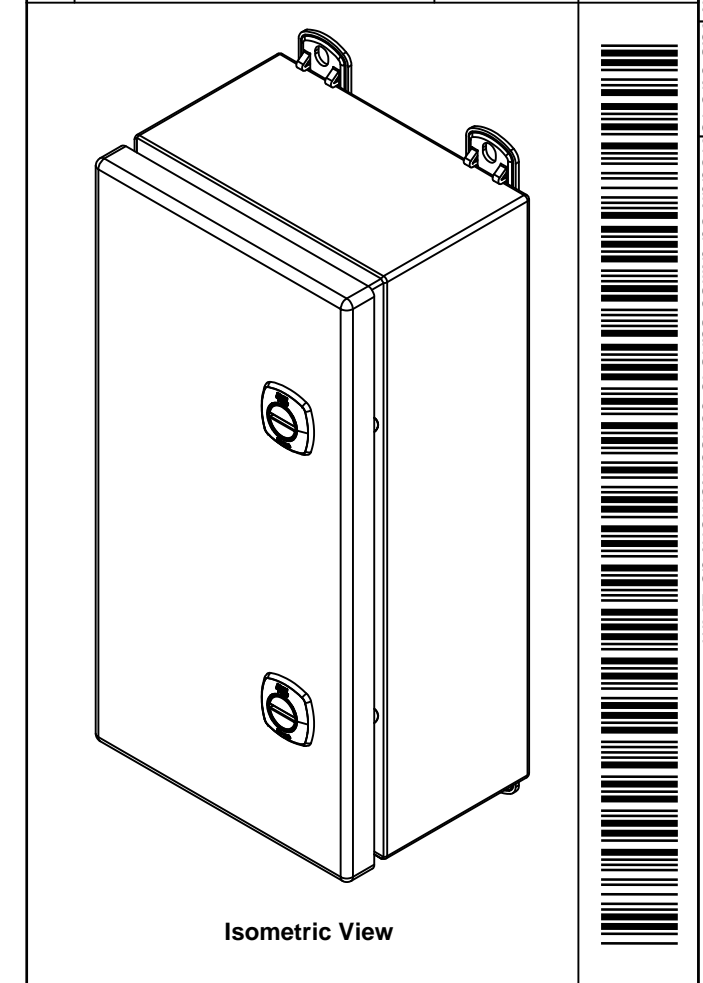

		Tél: (450) 979-4373 Fax: (450) 979-4626 www.exmweb.com		Flatness Aplatissement Max 3.0mm Projection 	
Customer Client		Date		Date 23-Oct-19	
Drawn By Dessiné Par BoxCad: BoxCad		Material Matière 16 Ga Stainless Steel 316 (1.4mm)		Color Couleur Unpainted	
Description 5412ESSM 12" x 6" x 4" Assembly		Finish Fini Brushed		Detail Rev.	
Part Number Numéro Pièce 5412ESSM1206046		Rev. 0		1 2	

SEE BILL OF MATERIAL ON LAST PAGE

This drawing is confidential and must not be reproduced or used without the consent of EXM

Ce dessin est confidentiel et ne doit pas être reproduit ou utilisé sans le consentement de EXM

NOTE	
ITEM	DESCRIPTION
1	NEMA 4X Enclosure
2	C/W Standard ground standoffs on box and cover
3	W/O Standard door stiffener
4	C/W Standard inner panel (Included)
5	C/W Standard inner panel mounting standoffs
6	C/W 885 ESCHMF2 Mounting Feet (Installed)

No.	Revisions	Date	By/Par

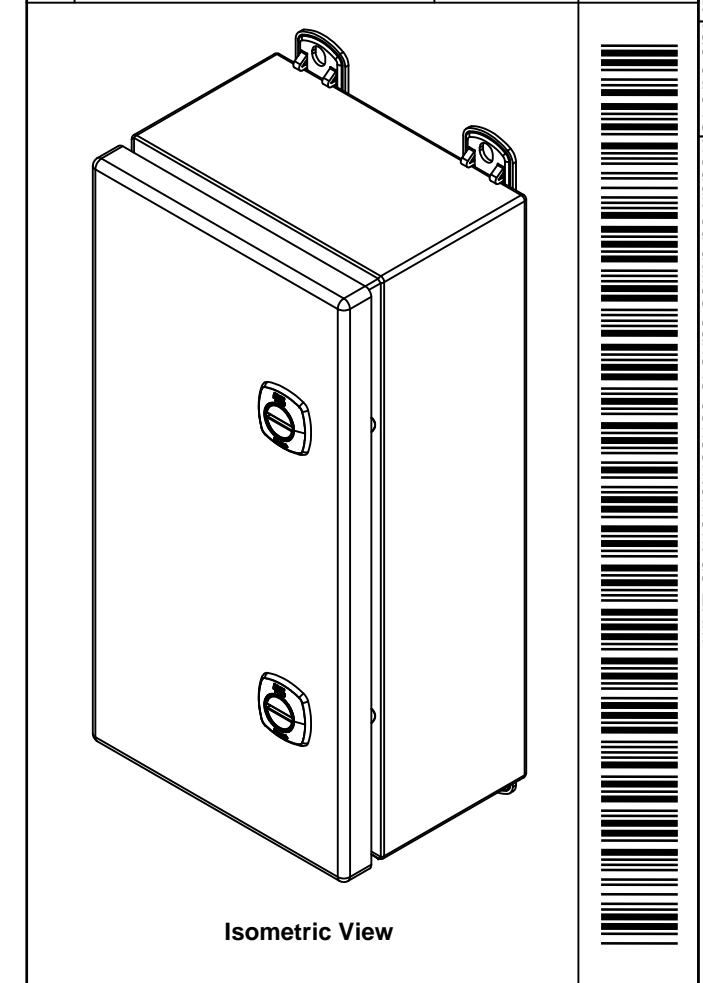

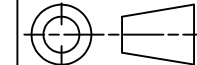
 Tél: (450) 979-4373 Fax: (450) 979-4626 www.exmweb.com	Flatness Aplatissement
	Max 3.0mm
Projection	
Customer Client	Date
Drawn By Dessiné Par	Date 23-Oct-19
Material Matière	16 Ga Stainless Steel 316 (1.4mm)

PACKING		
ITEM	QTY	DESCRIPTION
STK-E-04315	1	CARTON 5412 ESCH120604
Plastic bag	1	To protect cover surface and inside gasket
Packaging label	1	White label with product number
STK-S-01100	1	ESCH EXM SQUARE STICKER

Qty	Part Number	Rev	Description
1	5412ESSM1206046C	0	5412ESSM 12" x 6" Cover
1	885 ESSCHMFQ	0	5412 ESSCH Mounting Feet Accessory Kit
1	880 SP1206G	0	880 SP1206G - Inner Panel
1	STK-K-02910	3	5412 ESCH Accessory Kit
1	5412ESSM1206046B	0	5412ESSM 12" x 6" x 4" Body
2	STK-Q-08100	1	M5 Nylon Insert Lock Nut
Parts List			

Color Couleur	Unpainted	Finish Fini	Brushed
Description	5412ESSM 12" x 6" x 4" Assembly		
Part Number Numéro Pièce	5412ESSM1206046		Rev. 2
			0

This drawing is confidential and must not be reproduced or used without the consent of EXM

Ce dessin est confidentiel et ne doit pas être reproduit ou utilisé sans le consentement de EXM

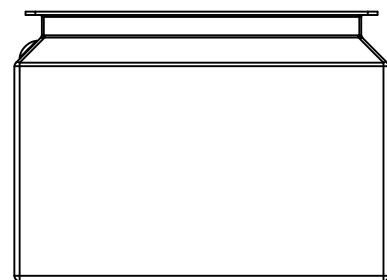

TOP

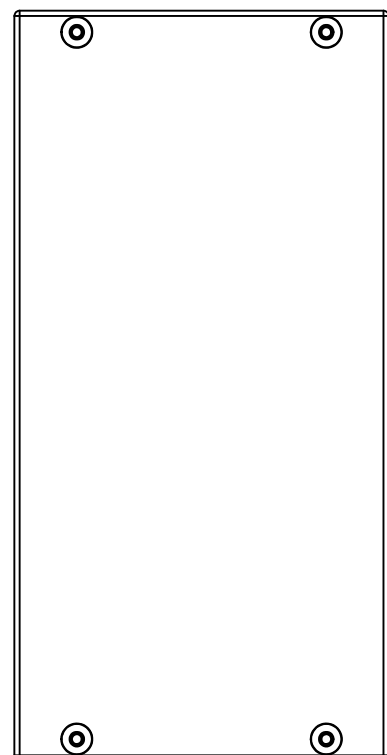

BACK

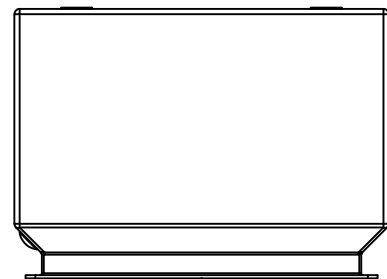

BOTTOM

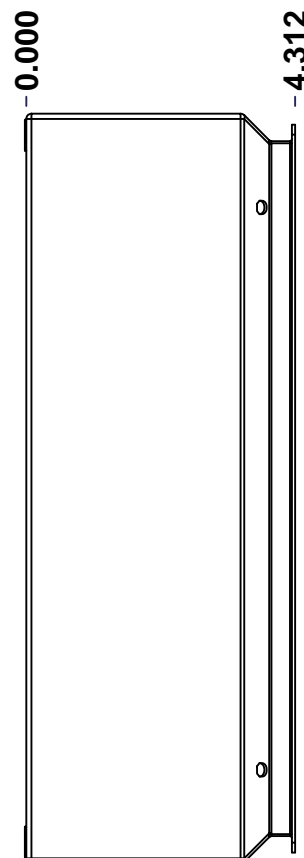

LEFT

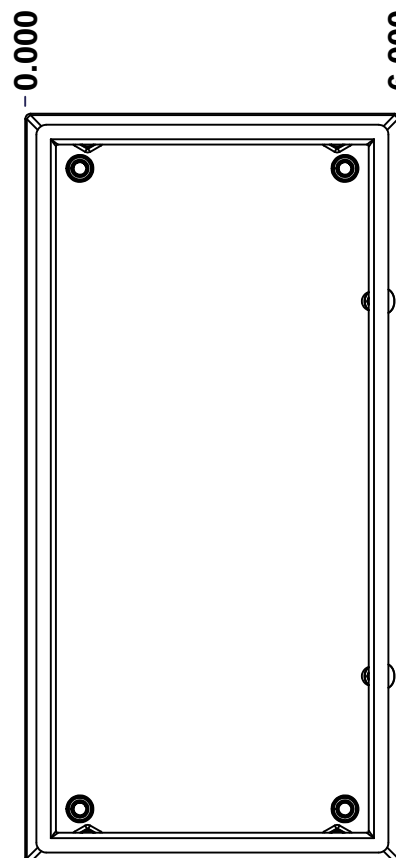

FRONT

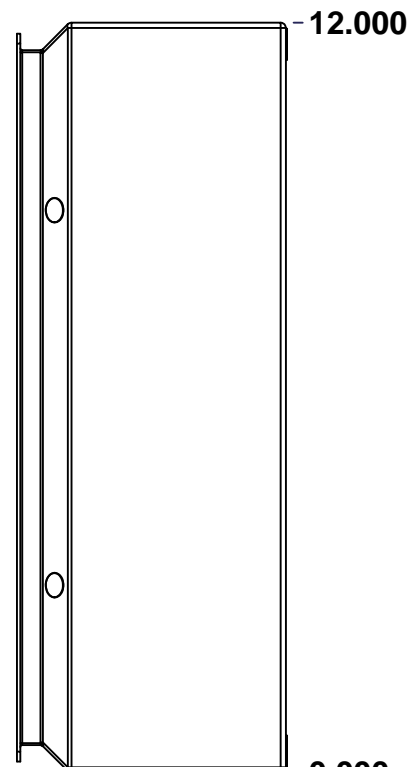

RIGHT

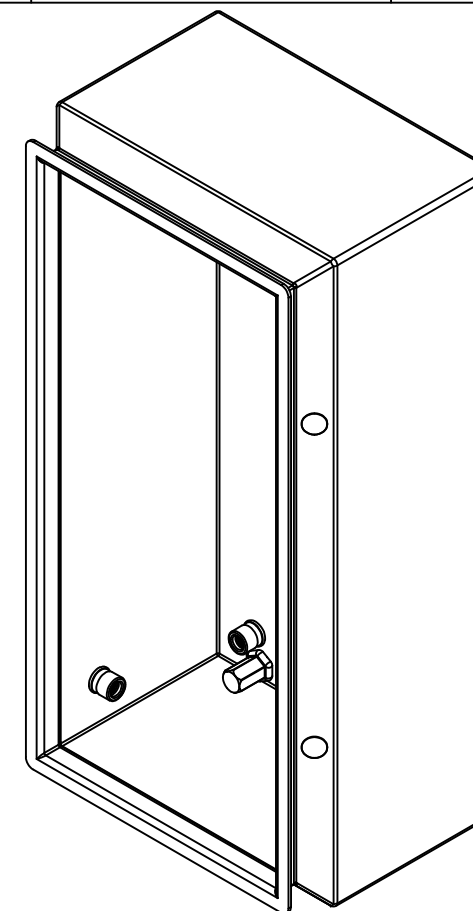

Isometric View



Tél: (450) 979-4373
 Fax: (450) 979-4626
www.exmweb.com

Flatness
Aplatissement

Max 3.0mm

Projection



Customer Client	Date
Drawn By / Dessiné Par: BoxCad: BoxCad	Date: 23-Oct-19

Material / Matière: 16 Ga Stainless Steel 316 (1.4mm)

Color / Couleur: Unpainted Finish / Fini: Brushed

Description: 5412ESSM 12" x 6" x 4" Body Detail Rev.

Part Number / Numéro Pièce: 5412ESSM1206046B	Rev. 0	1 / 7
--	--------	-------

SEE BILL OF MATERIAL ON LAST PAGE

This drawing is confidential and must not be reproduced or used without the consent of EXM

Ce dessin est confidentiel et ne doit pas être reproduit ou utilisé sans le consentement de EXM

STANDARD FEATURES ARE NOT LISTED IN THIS HOLE TABLE			
HOLE TABLE - LEFT VIEW (CUSTOM FEATURE ONLY)			
CUT-OUT	XDIM	YDIM	DESCRIPTION
1	2.625	0.875	STANDOFF M6 x 10mm (Inside)

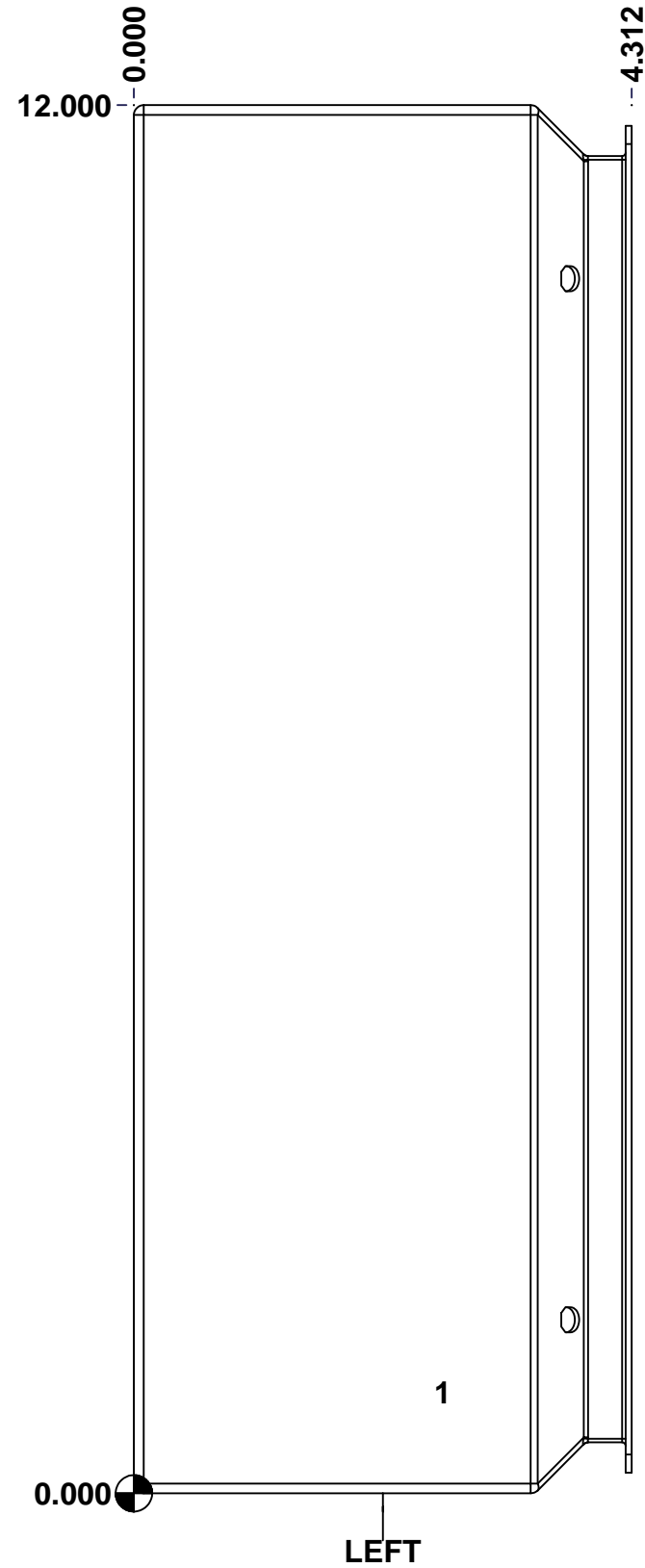

	Description	Status	
	5412ESSM 12" x 6" x 4" Body	(NULL)	
	Part Number Numéro Pièce	Rev.	5 7
	5412ESSM1206046B	0	

This drawing is confidential and must not be reproduced or used without the consent of EXM

Ce dessin est confidentiel et ne doit pas être reproduit ou utilisé sans le consentement de EXM

STANDARD FEATURES ARE NOT LISTED IN THIS HOLE TABLE

HOLE TABLE - BACK VIEW (CUSTOM FEATURE ONLY)

CUT-OUT	XDIM	YDIM	DESCRIPTION
1	0.875	0.875	IP STANDOFF M6 x 10mm (Inside)
2	0.875	11.125	IP STANDOFF M6 x 10mm (Inside)
3	5.125	11.125	IP STANDOFF M6 x 10mm (Inside)
4	5.125	0.875	IP STANDOFF M6 x 10mm (Inside)

5	1.000	12.000	FOOT 885 ESCHMF2
6	5.000	0.000	FOOT 885 ESCHMF2
7	1.000	0.000	FOOT 885 ESCHMF2
8	5.000	12.000	FOOT 885 ESCHMF2
9	1.000	11.656	RIVET NUT M6_FH_CE (Inside)
10	5.000	0.344	RIVET NUT M6_FH_CE (Inside)
11	1.000	0.344	RIVET NUT M6_FH_CE (Inside)
12	5.000	11.656	RIVET NUT M6_FH_CE (Inside)

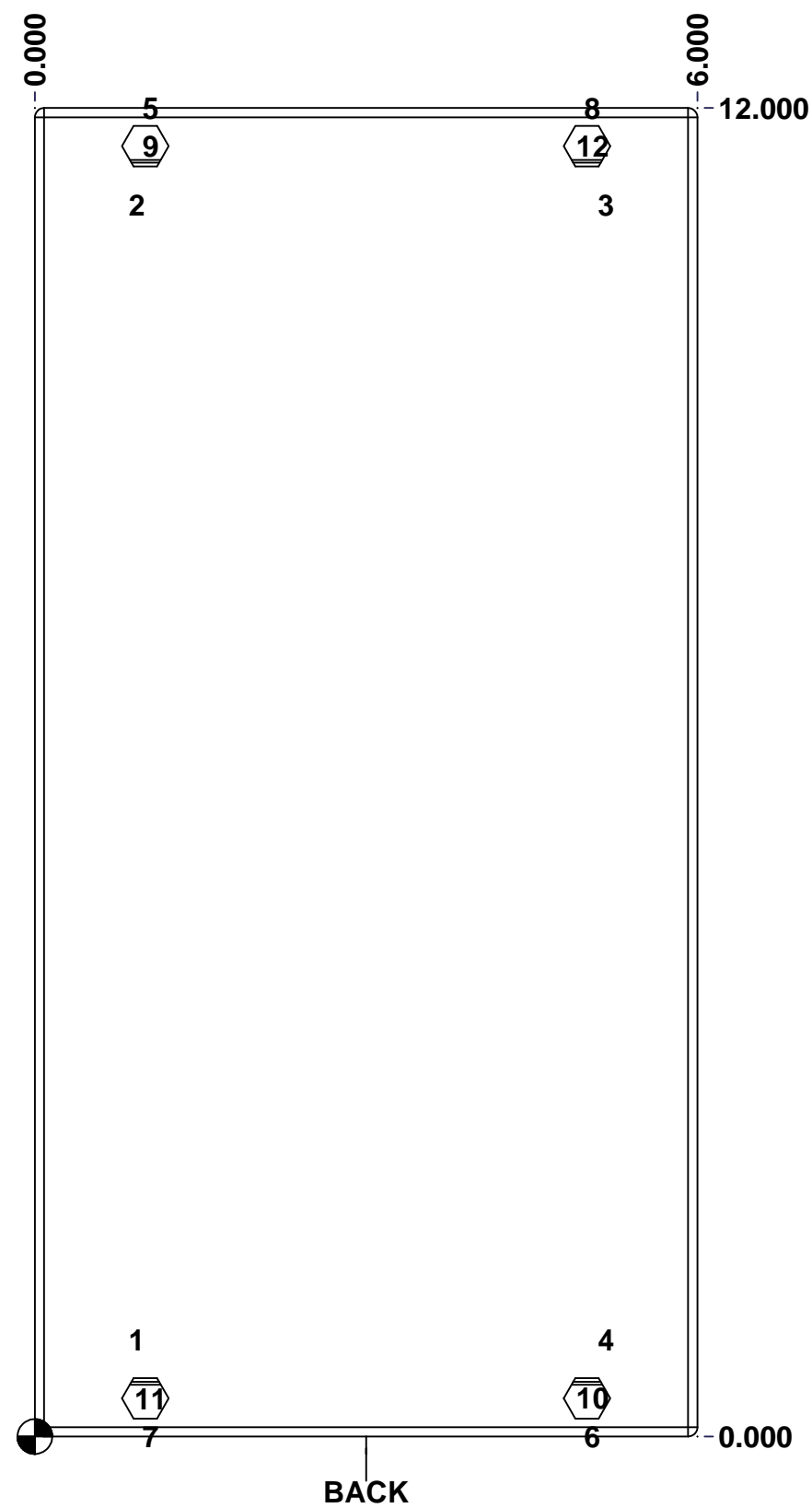

	Description	Status
	5412ESSM 12" x 6" x 4" Body	(NULL)
	Part Number Numéro Pièce	Rev.
	5412ESSM1206046B	0
		6
		7

This drawing is confidential and must not be reproduced or used without the consent of EXM

Ce dessin est confidentiel et ne doit pas être reproduit ou utilisé sans le consentement de EXM

No.	Revisions	Date	By/Par

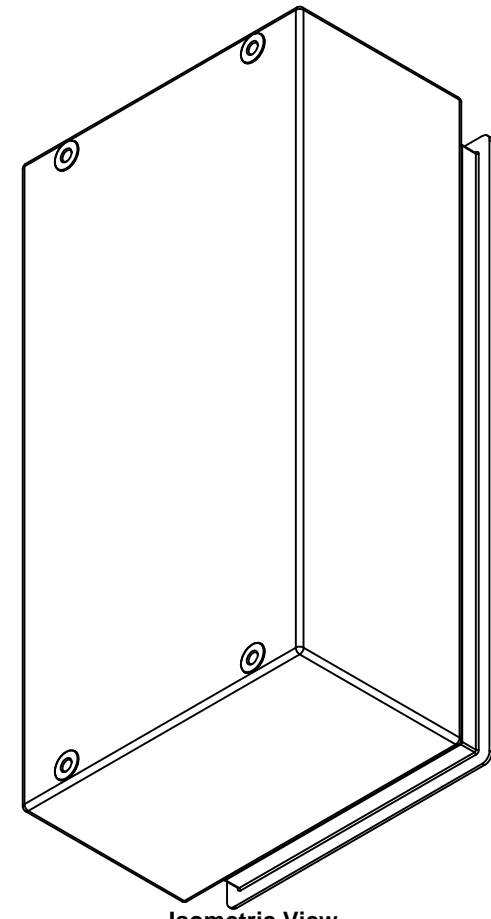

Isometric View



Tél: (450) 979-4373
 Fax: (450) 979-4626
www.exmweb.com

Flatness
Aplatissement
Max 3.0mm
Projection

Customer Client	Date
Drawn By / Dessiné Par: BoxCad: BoxCad	Date: 23-Oct-19
Material / Matière: 16 Ga Stainless Steel 316 (1.4mm)	

Color / Couleur: Unpainted	Finish / Fini: Brushed
----------------------------	------------------------

Description: 5412ESSM 12" x 6" x 4" Body	Detail Rev.
--	-------------

Part Number / Numéro Pièce: 5412ESSM1206046B	Rev. 0	7
---	--------	---

Qty	Part Number	Rev	Description
4	RIVET_NUT_SS_M6_FH_CE	0	Stainless Steel Rivet Nut M6 (Low Profile Close End)
2	STK-Q-08112	3	M5 Stainless Steel 304 Nylon Insert Dome Nut
1	5412ESSM1206046B-P	0	5412ESSM 12" x 6" x 4" Body Part
2	STK-Q-00200	0	M5 x 8mm Stainless Steel 316 Carriage Bolt with Nyseal
5	STK-Q-08500	4	Stainless Steel Standoff M6 x 10mm
Parts List			

This drawing is confidential and must not be reproduced or used without the consent of EXM

Ce dessin est confidentiel et ne doit pas être reproduit ou utilisé sans le consentement de EXM

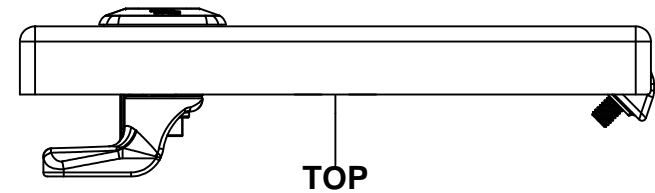

TOP

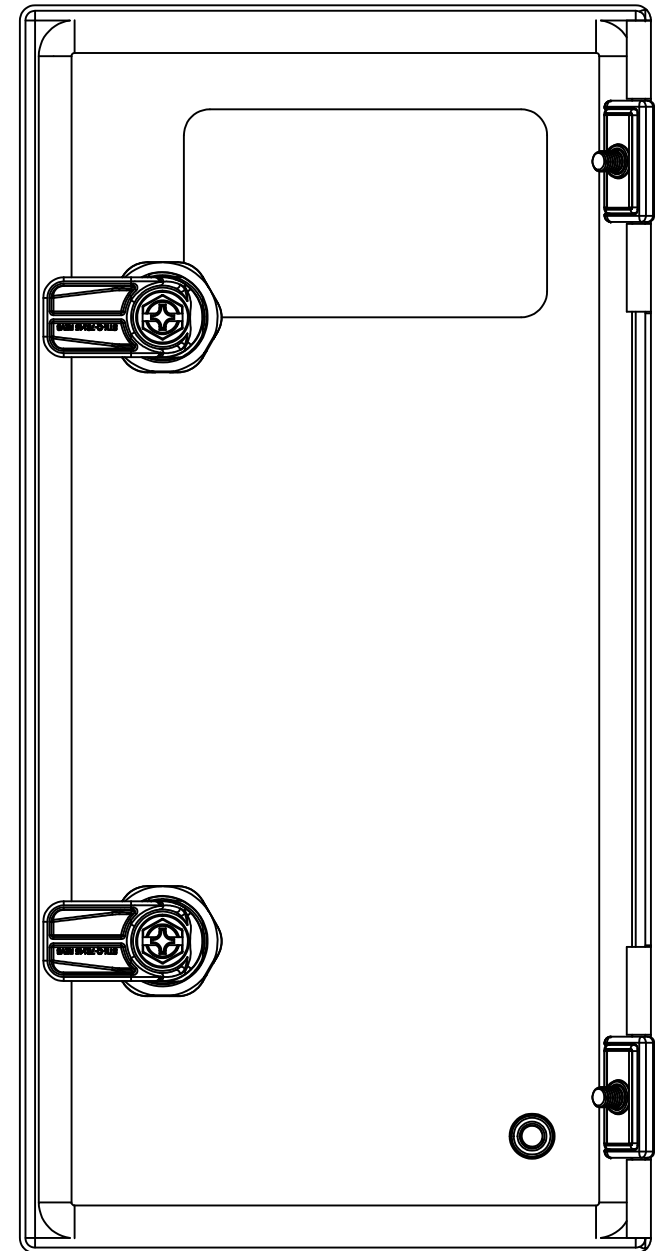

BACK

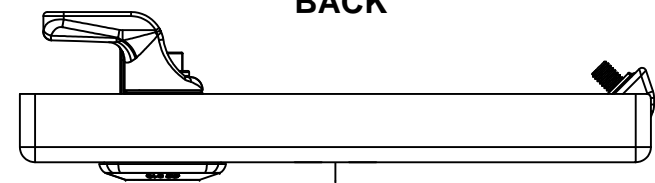

BOTTOM

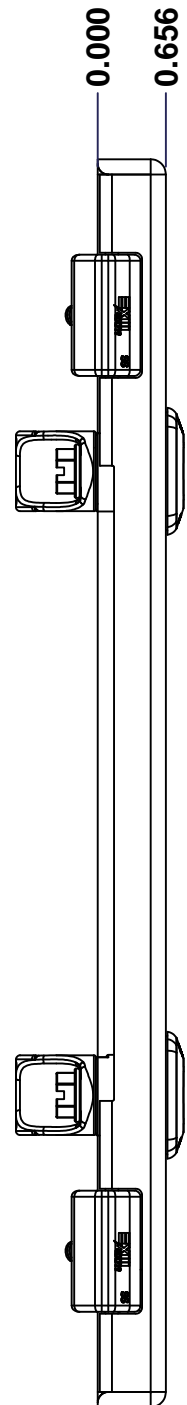

LEFT

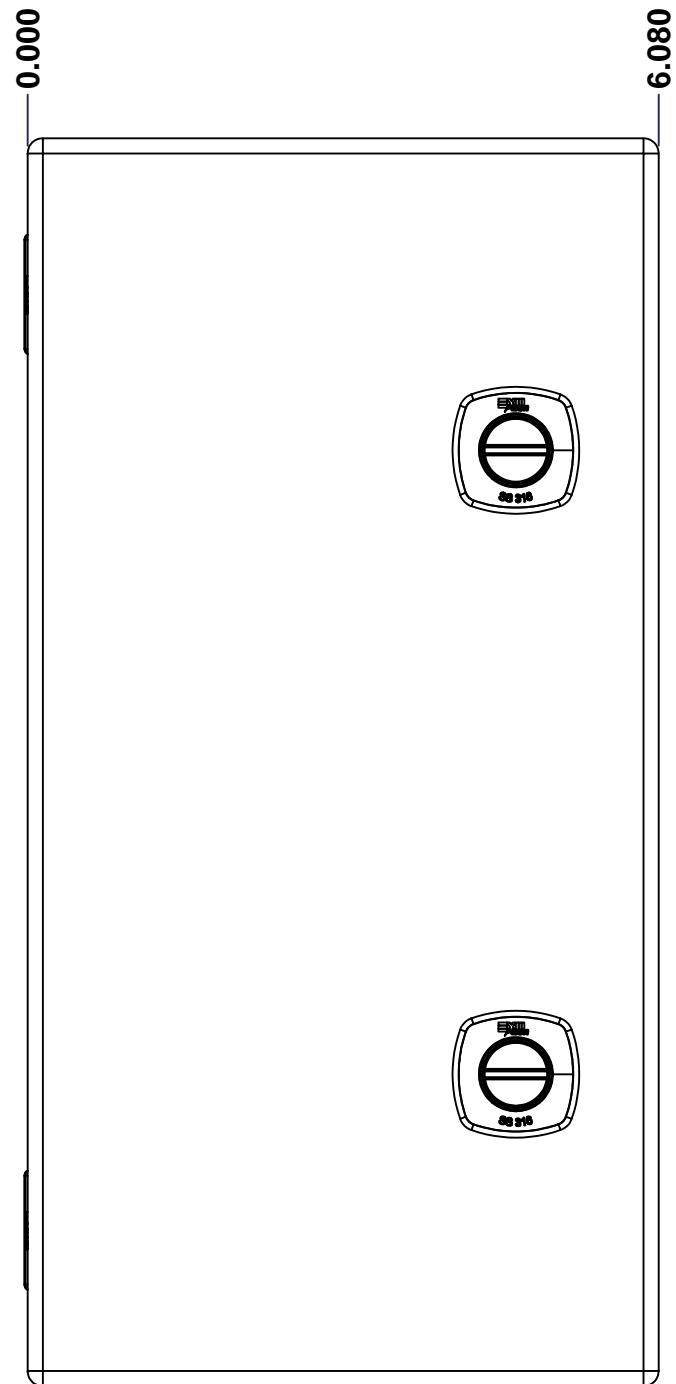

FRONT

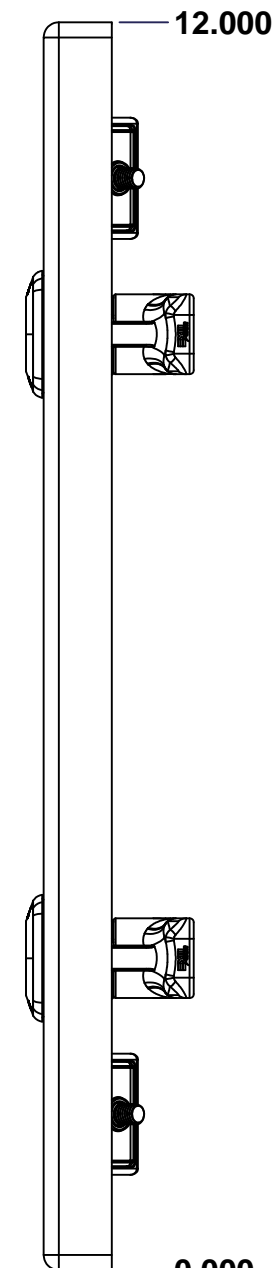

RIGHT

No.	Revisions	Date	By/Par

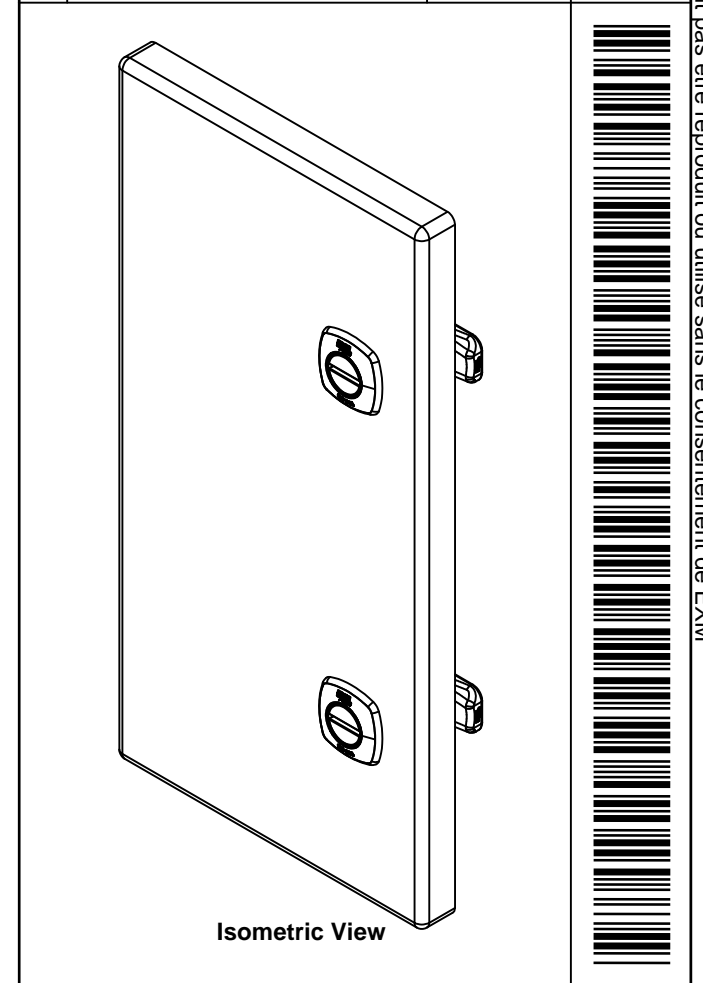

Isometric View

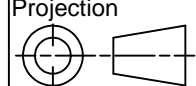

 Tél: (450) 979-4373 Fax: (450) 979-4626 www.exmweb.com		Flatness Aplatissement Max 3.0mm Projection 
Customer Client	Date	Date
Drawn By Dessiné Par	BoxCad: BoxCad	Date 23-Oct-19
Material Matière	16 Ga Stainless Steel 316 (1.4mm)	
Color Couleur	Unpainted	Finish Fini Brushed
Description	Detail Rev.	
5412ESSM 12" x 6" Cover		
Part Number Numéro Pièce	Rev.	1
5412ESSM1206046C	0	3

SEE BILL OF MATERIAL ON LAST PAGE

This drawing is confidential and must not be reproduced or used without the consent of EXM

Ce dessin est confidentiel et ne doit pas être reproduit ou utilisé sans le consentement de EXM

STANDARD FEATURES ARE NOT LISTED IN THIS HOLE TABLE			
HOLE TABLE - FRONT VIEW (CUSTOM FEATURE ONLY)			
CUT-OUT	XDIM	YDIM	DESCRIPTION
1	1.145	1.125	STANDOFF M6 x 10mm (Inside)
2	2.750	10.000	LABEL_EXM
3	4.705	9.000	LOCK 880 SCQ4-SLSS6 @ 0.0°
4	4.705	LOCK 880 SCQ4-SLSS6 @ 0.0°	

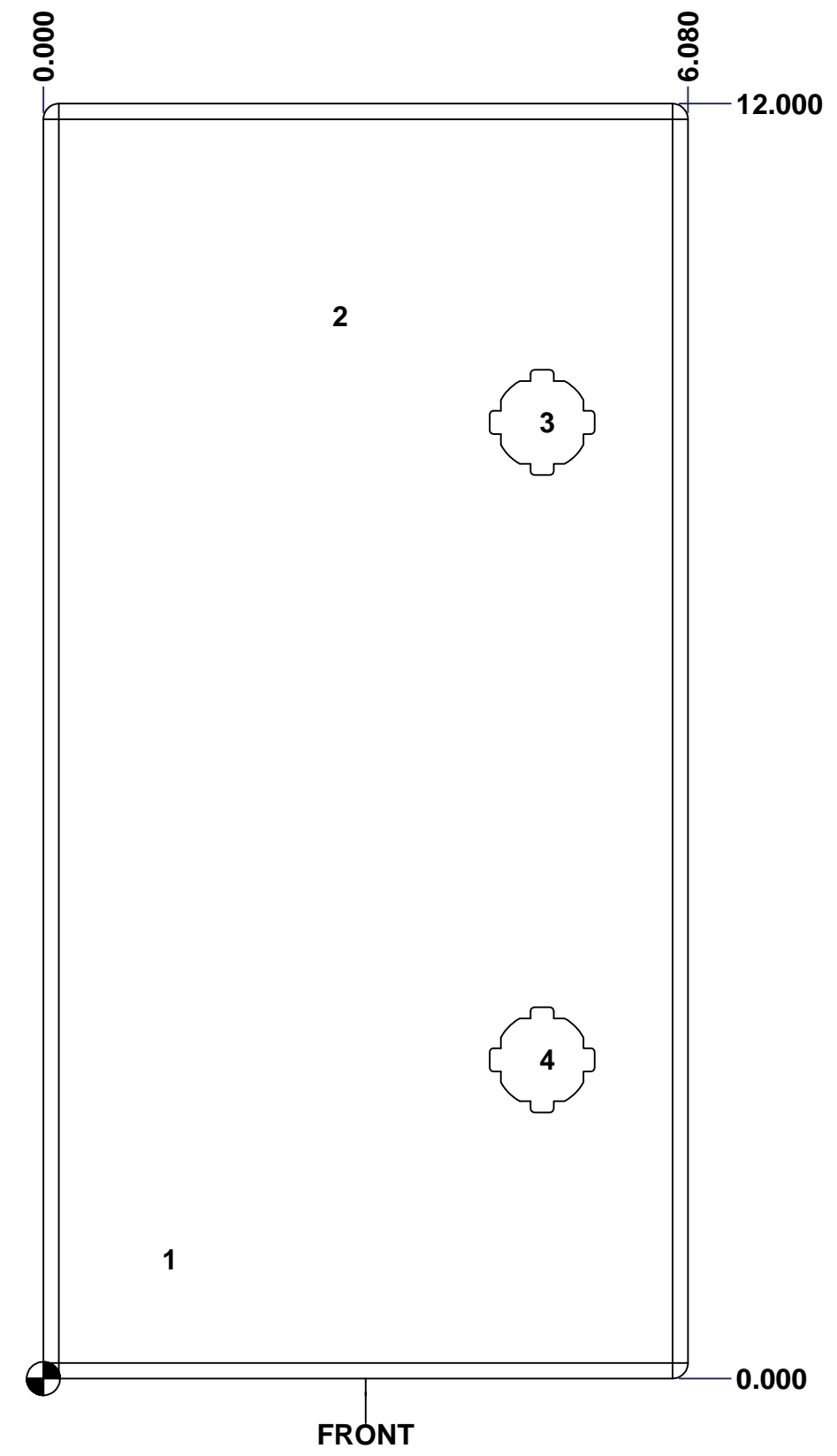



	Description	Status	
	5412ESSM 12" x 6" Cover	(NULL)	
	Part Number Numéro Pièce	Rev.	
	5412ESSM1206046C	0	2 3

This drawing is confidential and must not be reproduced or used without the consent of EXM

Ce dessin est confidentiel et ne doit pas être reproduit ou utilisé sans le consentement de EXM

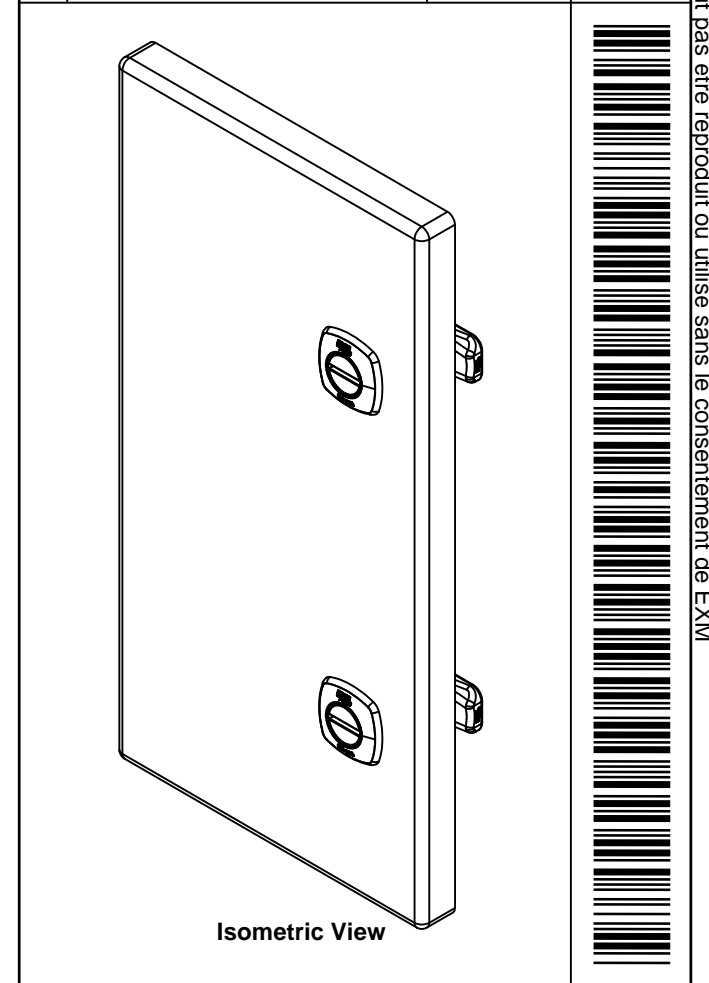
No.	Revisions	Date	By/Par

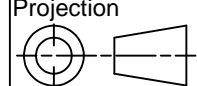

 Tél: (450) 979-4373 Fax: (450) 979-4626 www.exmweb.com		Flatness Aplatissement Max 3.0mm Projection 
Customer Client	Date	
Drawn By Dessiné Par	BoxCad: BoxCad	Date 23-Oct-19
Material Matière	16 Ga Stainless Steel 316 (1.4mm)	
Color Couleur	Unpainted	Finish Fini Brushed
Description		Detail Rev.
5412ESSM 12" x 6" Cover		
Part Number Numéro Pièce	Rev.	3
5412ESSM1206046C	0	3

Qty	Part Number	Rev	Description
1	5412ESSM1206046G	0	5412ESSM 12" x 6" Gasket
1	STK-S-00100	0	3.5" x 2" Silver Milar Flexcon Sticker
1	STK-Q-08500	4	Stainless Steel Standoff M6 x 10mm
1	5412ESSM1206046C-P	0	5412ESSM 12" x 6" Cover Part
2	STK-A-33038	3	5412 ESSMCH - Stainless Steel Hinge
2	880 SCQ4-SLSS6	7	5412 ESS 1/4 Turn Lock
Parts List			

This drawing is confidential and must not be reproduced or used without the consent of EXM

Ce dessin est confidentiel et ne doit pas être reproduit ou utilisé sans le consentement de EXM

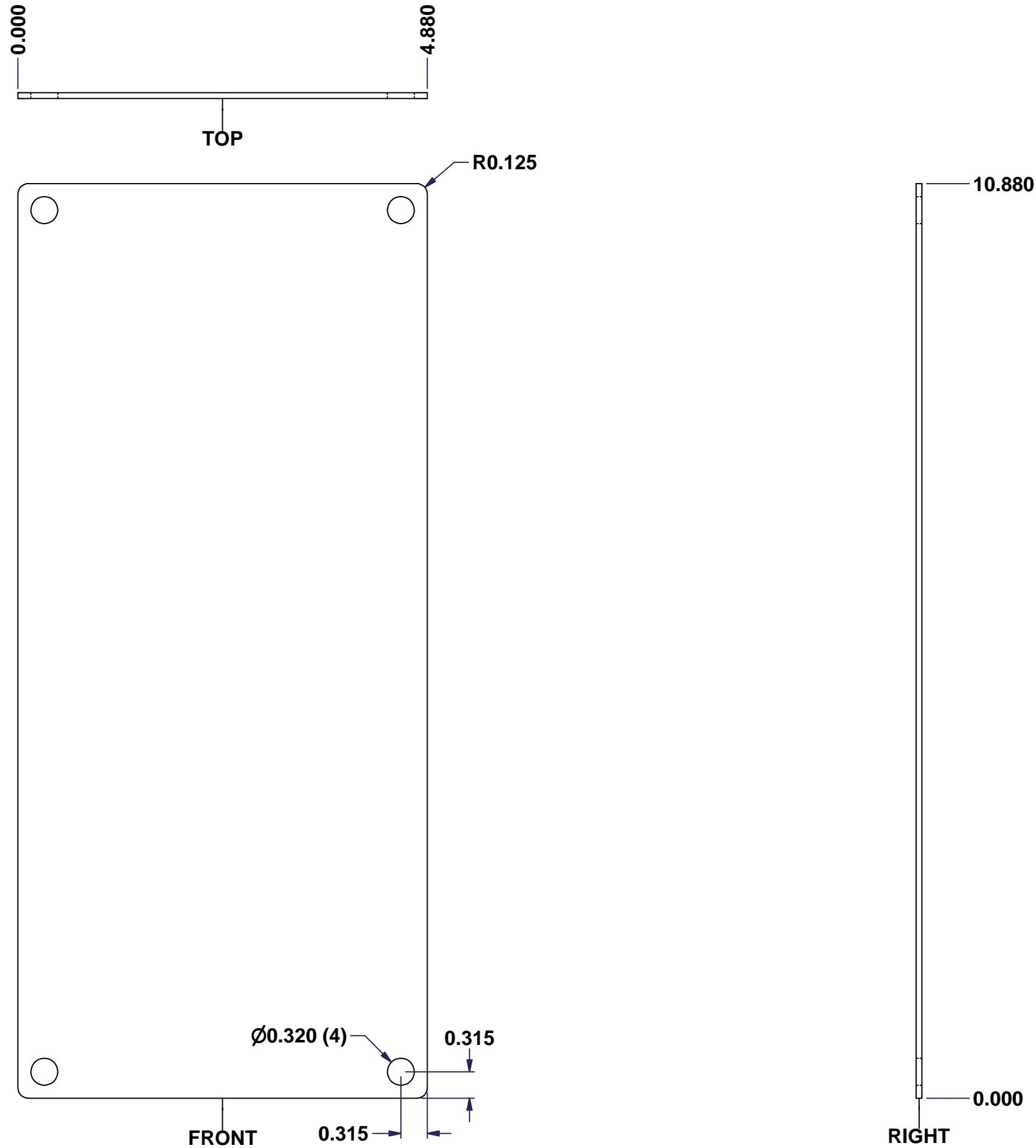

No.	Revisions	Date	By/Par

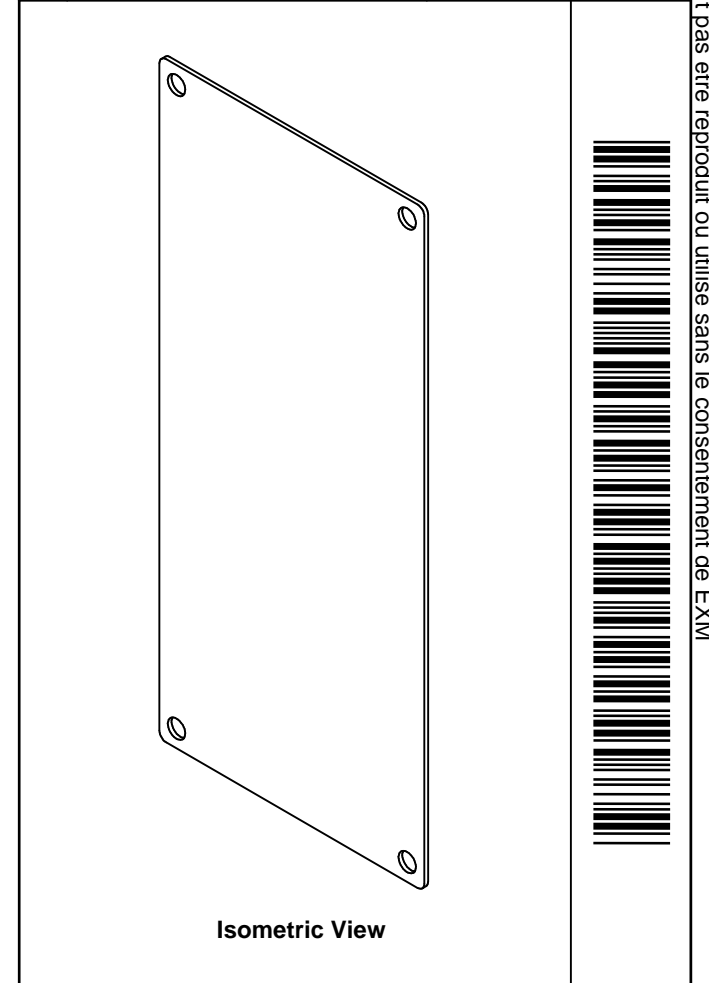

 Tél: (450) 979-4373 Fax: (450) 979-4626 www.exmweb.com		Flatness Aplatissement	
		Max 3.0mm	
Customer Client		Date	
Drawn By Dessiné Par BoxCad		Date 23-Jan-07	
Material Matière		14 Ga Galvanized (1.7mm)	
Color Couleur Unpainted		Finish Fini Galvanized	
Description		Detail Rev.	
880 SP1206G - Inner Panel			
Part Number Numéro Pièce		Rev.	
880 SP1206G		0	1 2

SEE BILL OF MATERIAL ON LAST PAGE

This drawing is confidential and must not be reproduced or used without the consent of EXM

Ce dessin est confidentiel et ne doit pas être reproduit ou utilisé sans le consentement de EXM

No.	Revisions	Date	By/Par

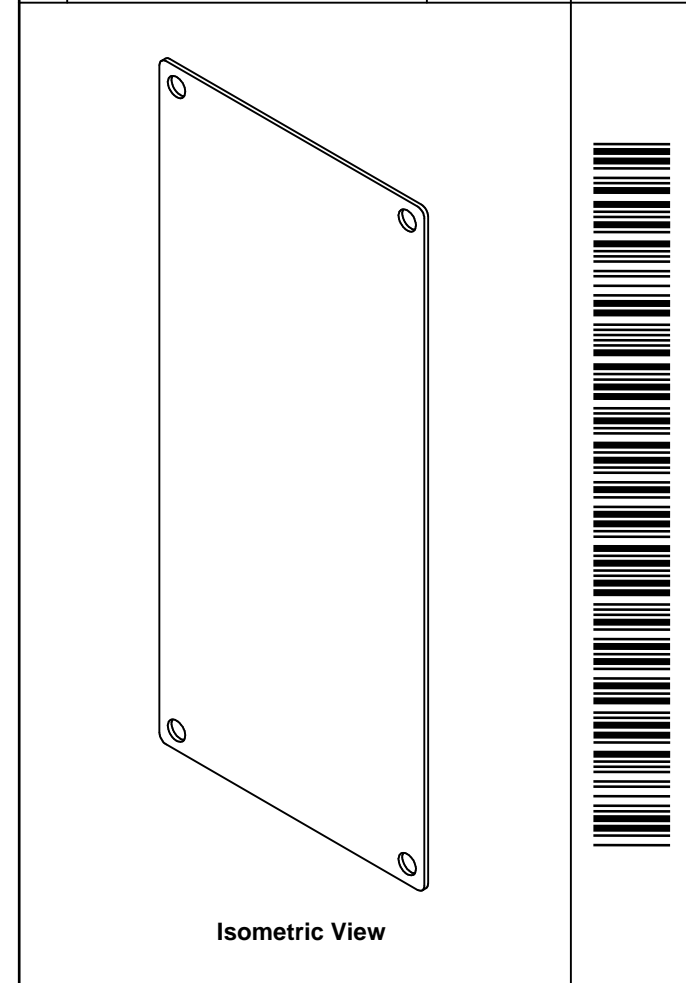

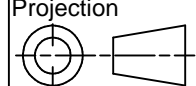
 Tél: (450) 979-4373 Fax: (450) 979-4626 www.exmweb.com		Flatness Aplatissement Max 3.0mm
Customer Client		Projection 
Drawn By Dessiné Par BoxCad		Date 23-Jan-07
Material Matière 14 Ga Galvanized (1.7mm)		
Color Couleur Unpainted	Finish Fini Galvanized	
Description 880 SP1206G - Inner Panel		Detail Rev.
Part Number Numéro Pièce 880 SP1206G		Rev. 0

Qty	Part Number	Rev	Description
1	880 SP1206G-P	0	880 SP1206G - Inner Panel Part
Parts List			

2
2