

This drawing is confidential and must not be reproduced or used without the consent of EXM

Ce dessin est confidentiel et ne doit pas être reproduit ou utilisé sans le consentement de EXM

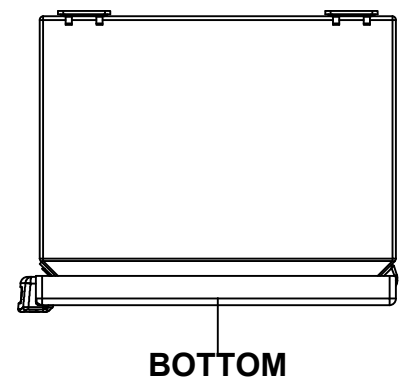

No.	Revisions	Date	By/Par

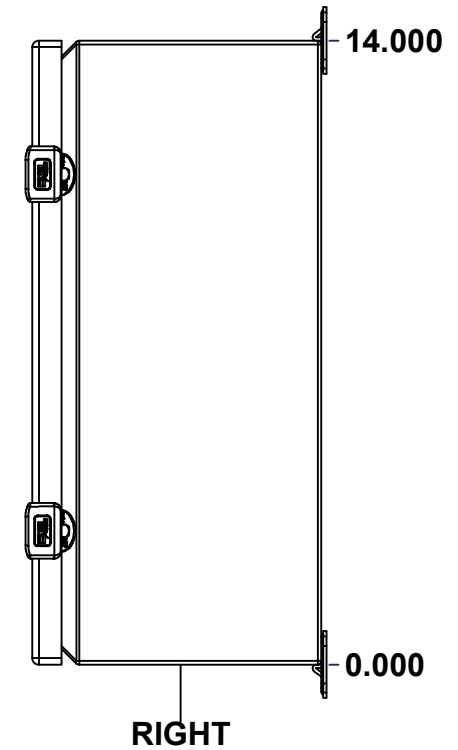
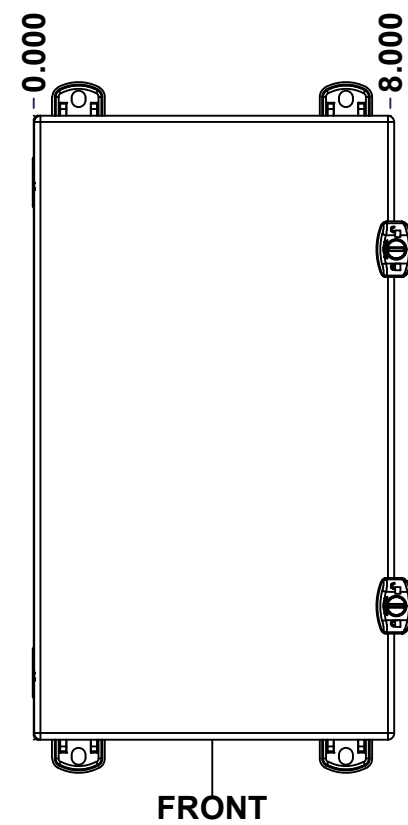
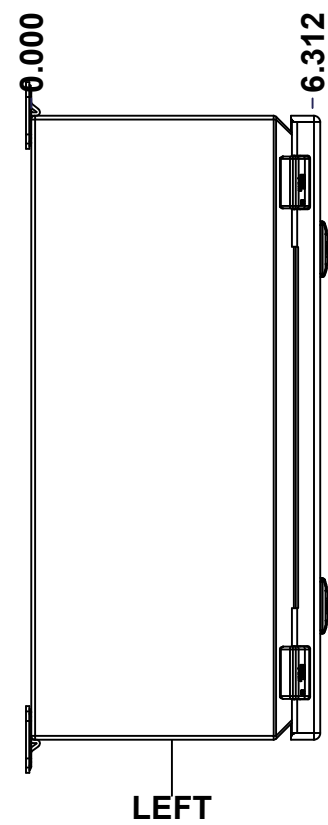
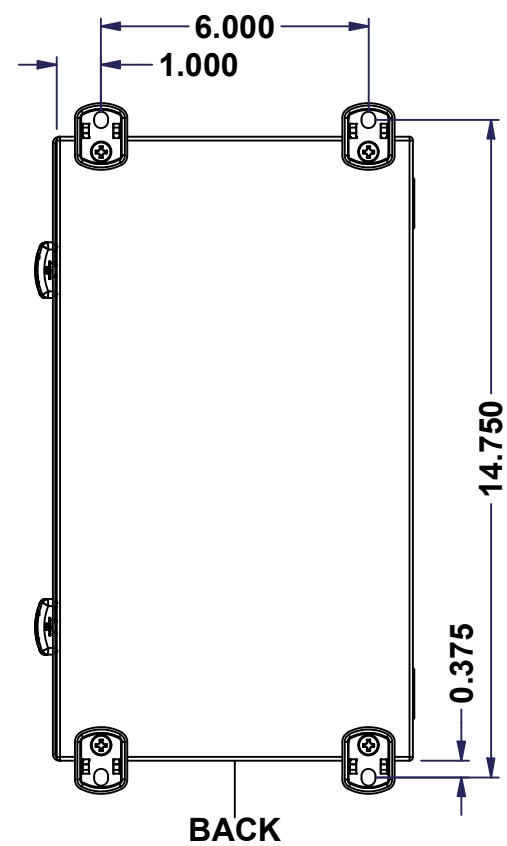
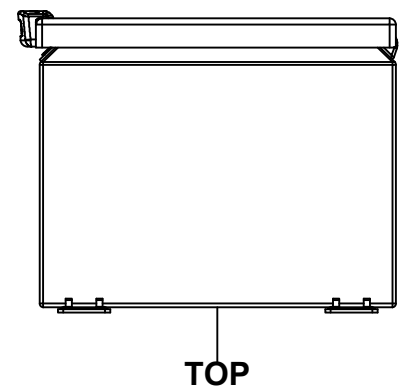
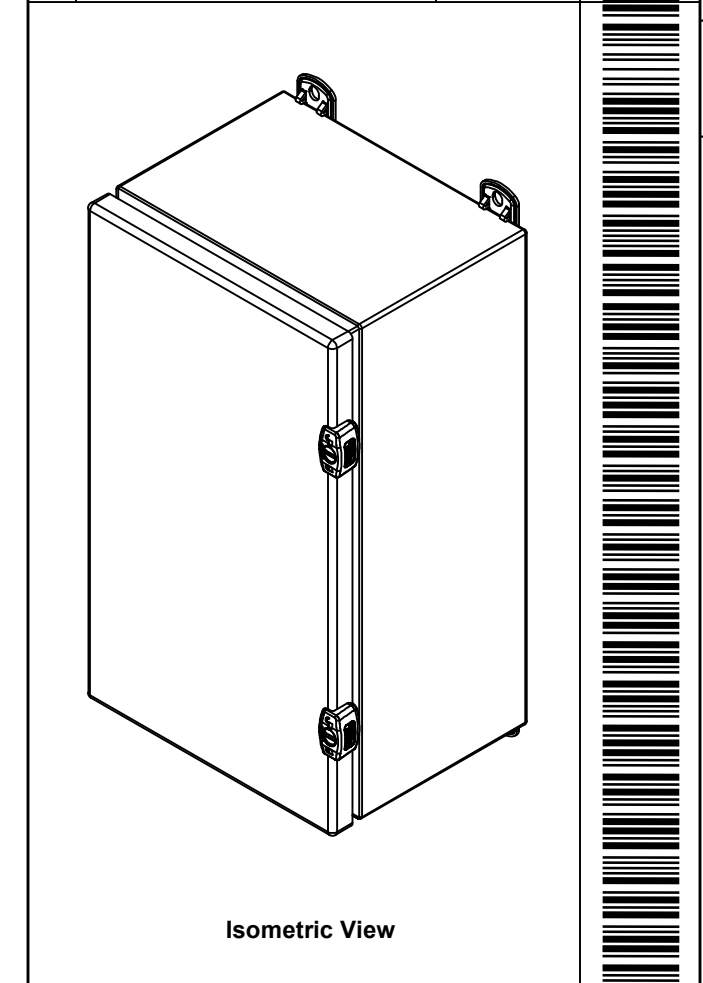

**GRAIN DIRECTION:
TOP/BOTTOM: HORIZONTAL
LEFT/RIGHT/BACK/FRONT: VERTICAL**

Tél: (450) 979-4373 Fax: (450) 979-4626 www.exmweb.com		Flatness Aplatissement Max 3.0mm Projection
Customer Client		Date
Drawn By Dessiné Par	BoxCad: BoxCad	Date 13-Mar-23
Material Matière	16 Ga Stainless Steel 316 (1.4mm)	
Color Couleur	Unpainted	Finish Fini Brushed
Description	Detail Rev.	
5412ESSMCH 14" x 8" x 6" Assembly		
Part Number Numéro Pièce	Rev. 0	1 9

SEE BILL OF MATERIAL ON LAST PAGE **5412ESSMCH1408066NOIP**

This drawing is confidential and must not be reproduced or used without the consent of EXM

Ce dessin est confidentiel et ne doit pas être reproduit ou utilisé sans le consentement de EXM

NOTE	
ITEM	DESCRIPTION
1	NEMA 4X Enclosure
2	C/W Standard ground standoffs on box and cover
3	W/O Standard door stiffener
4	W/O Inner panel
5	C/W Standard inner panel mounting standoffs
6	C/W 885 ESCHMF2 Mounting Feet (Kit)

No.	Revisions	Date	By/Par

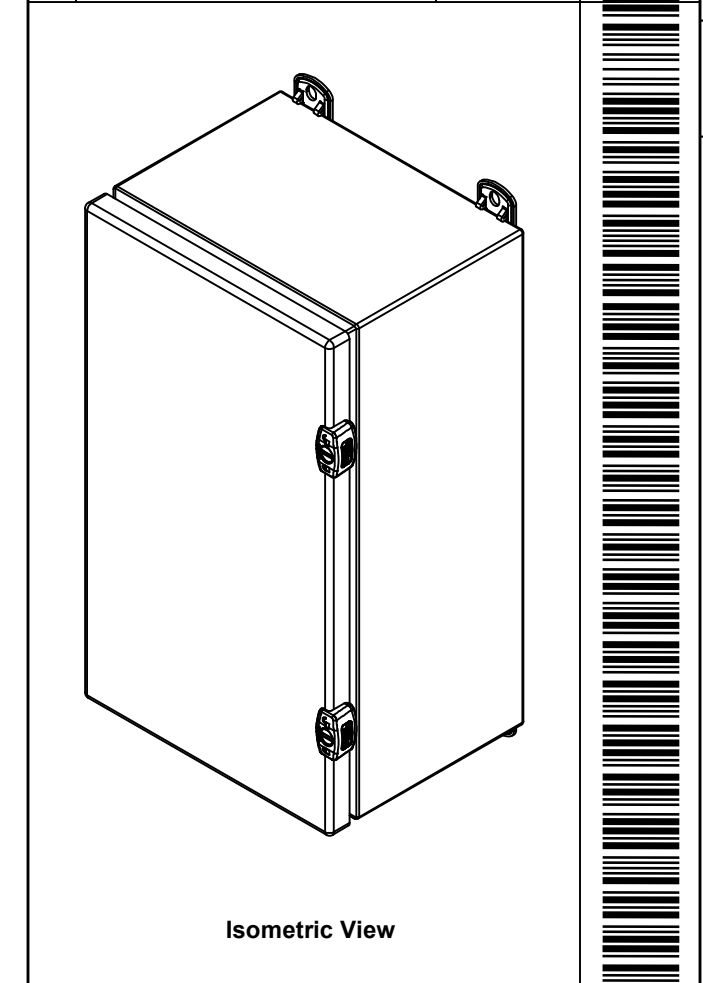

	Tél: (450) 979-4373 Fax: (450) 979-4626 www.exmweb.com	Flatness Aplatissement Max 3.0mm
		Projection
Customer Client	Date	
Drawn By Dessiné Par	BoxCad: BoxCad	Date 13-Mar-23
Material Matière	16 Ga Stainless Steel 316 (1.4mm)	
Color Couleur	Unpainted	Finish Fini Brushed
Description	Detail Rev.	
5412ESSMCH 14" x 8" x 6" Assembly		
Part Number Numéro Pièce	Rev. 0	2 9

PACKING		
ITEM	QTY	DESCRIPTION
STK-E-04321	1	CARTON 5412 ESCH140806
Plastic bag	1	To protect cover surface and inside gasket
Packaging label	1	White label with product number
STK-S-01100	1	ESCH EXM SQUARE STICKER

Qty	Part Number	Rev	Description
1	STK-K-02945	0	5412 ESSMCH Accessory Kit
1	5412ESSMCH1408066NO IPC	0	5412ESSMCH 14" x 8" Cover
1	5412ESSMCH1408066NO IPB	0	5412ESSMCH 14" x 8" x 6" Body
2	STK-Q-08100	1	M5 Nylon Insert Lock Nut
2	STK-Q-10249	0	M5 Sealing Washer

Parts List

This drawing is confidential and must not be reproduced or used without the consent of EXM

Ce dessin est confidentiel et ne doit pas être reproduit ou utilisé sans le consentement de EXM

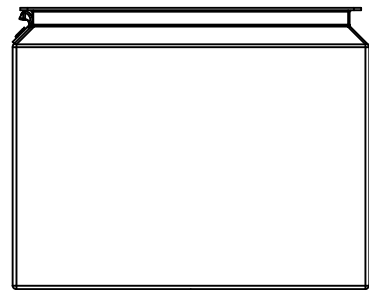

TOP

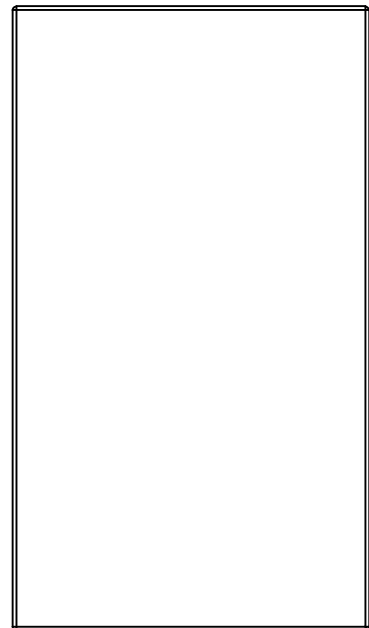

BACK

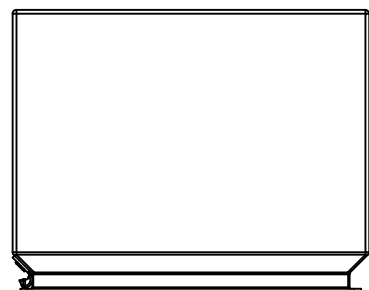

BOTTOM

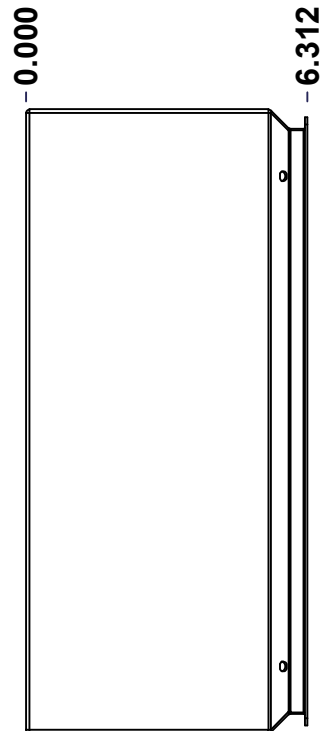

LEFT

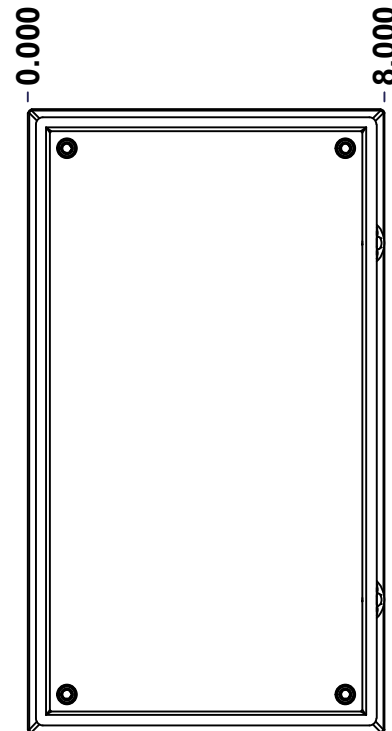

FRONT

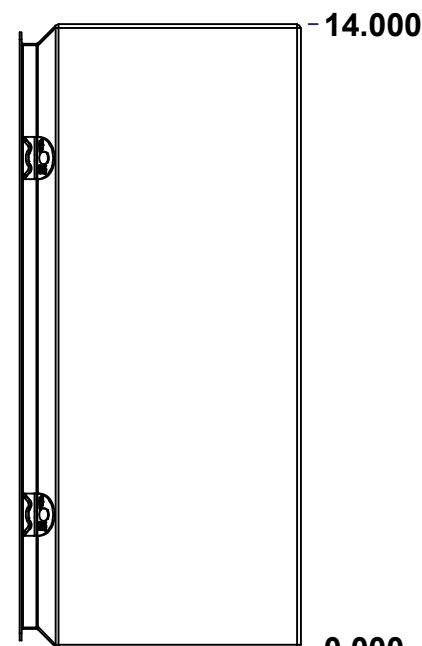

RIGHT

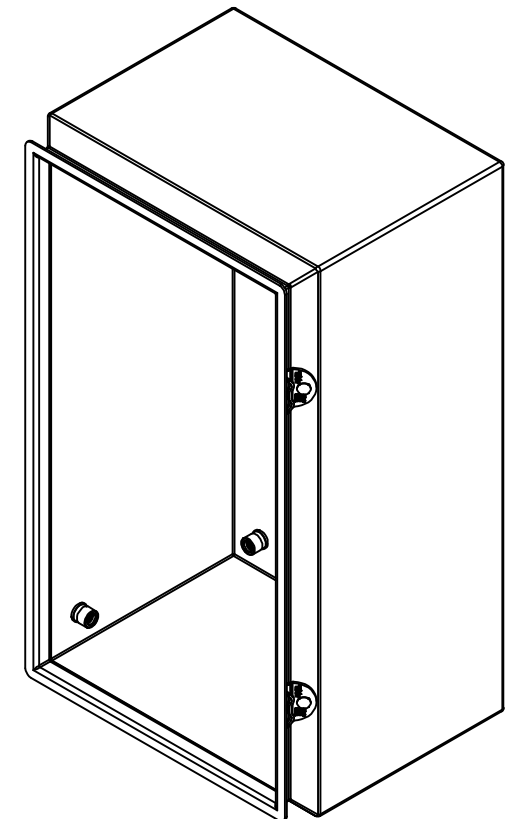

Isometric View

No.	Revisions	Date	By/Par



Tél: (450) 979-4373
 Fax: (450) 979-4626
www.exmweb.com

Flatness
 Aplatissement
 Max 5.0mm
 Projection

Customer Client	Date
Drawn By Dessiné Par BoxCad: BoxCad	Date 13-Mar-23
Material Matière 16 Ga Stainless Steel 316 (1.4mm)	
Color Couleur Unpainted	Finish Fini Brushed
Description 5412ESSMCH 14" x 8" x 6" Body	Detail Rev.

Part Number Numéro Pièce	Rev. 3
-----------------------------	--------

This drawing is confidential and must not be reproduced or used without the consent of EXM

Ce dessin est confidentiel et ne doit pas être reproduit ou utilisé sans le consentement de EXM

STANDARD FEATURES ARE NOT LISTED IN THIS HOLE TABLE			
HOLE TABLE - LEFT VIEW (CUSTOM FEATURE ONLY)			
CUT-OUT	XDIM	YDIM	DESCRIPTION
1	4.625	0.875	STANDOFF M6 x 10mm (Inside)

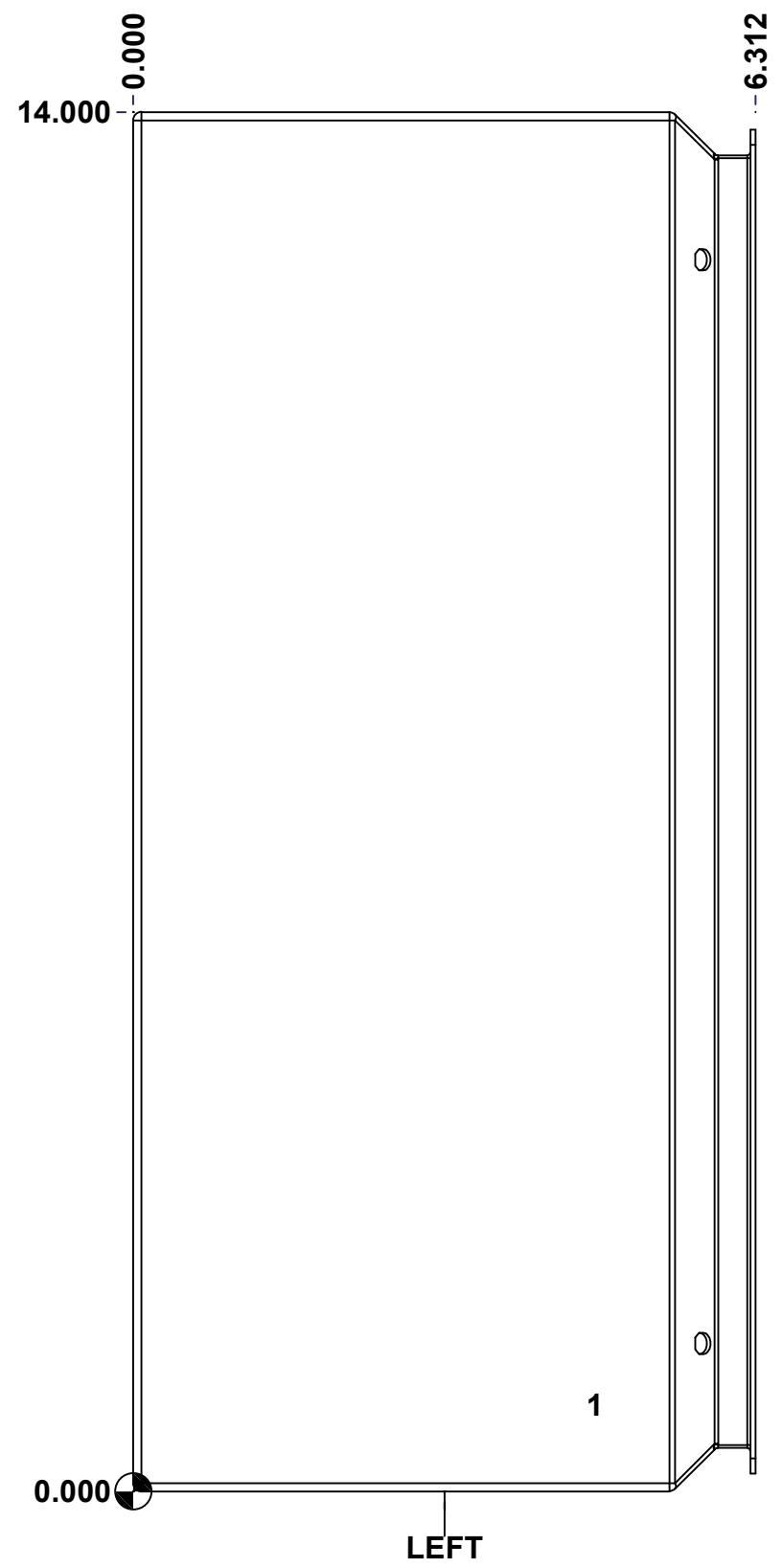

	Description	Status
	5412ESSMCH 14" x 8" x 6" Body	(NULL)
	Part Number Numéro Pièce	Rev.
	5412ESSMCH1408066NOIPB 0	4 9

This drawing is confidential and must not be reproduced or used without the consent of EXM

Ce dessin est confidentiel et ne doit pas être reproduit ou utilisé sans le consentement de EXM

STANDARD FEATURES ARE NOT LISTED IN THIS HOLE TABLE			
HOLE TABLE - BACK VIEW (CUSTOM FEATURE ONLY)			
CUT-OUT	XDIM	YDIM	DESCRIPTION
1	0.875	0.875	IP STANDOFF M6 x 10mm (Inside)
2	0.875	13.125	IP STANDOFF M6 x 10mm (Inside)
3	7.125	13.125	IP STANDOFF M6 x 10mm (Inside)
4	7.125	0.875	IP STANDOFF M6 x 10mm (Inside)

5	1.000	0.000	FOOT 885 ESCHMF2
6	7.000	14.000	FOOT 885 ESCHMF2
7	1.000	14.000	FOOT 885 ESCHMF2
8	7.000	0.000	FOOT 885 ESCHMF2

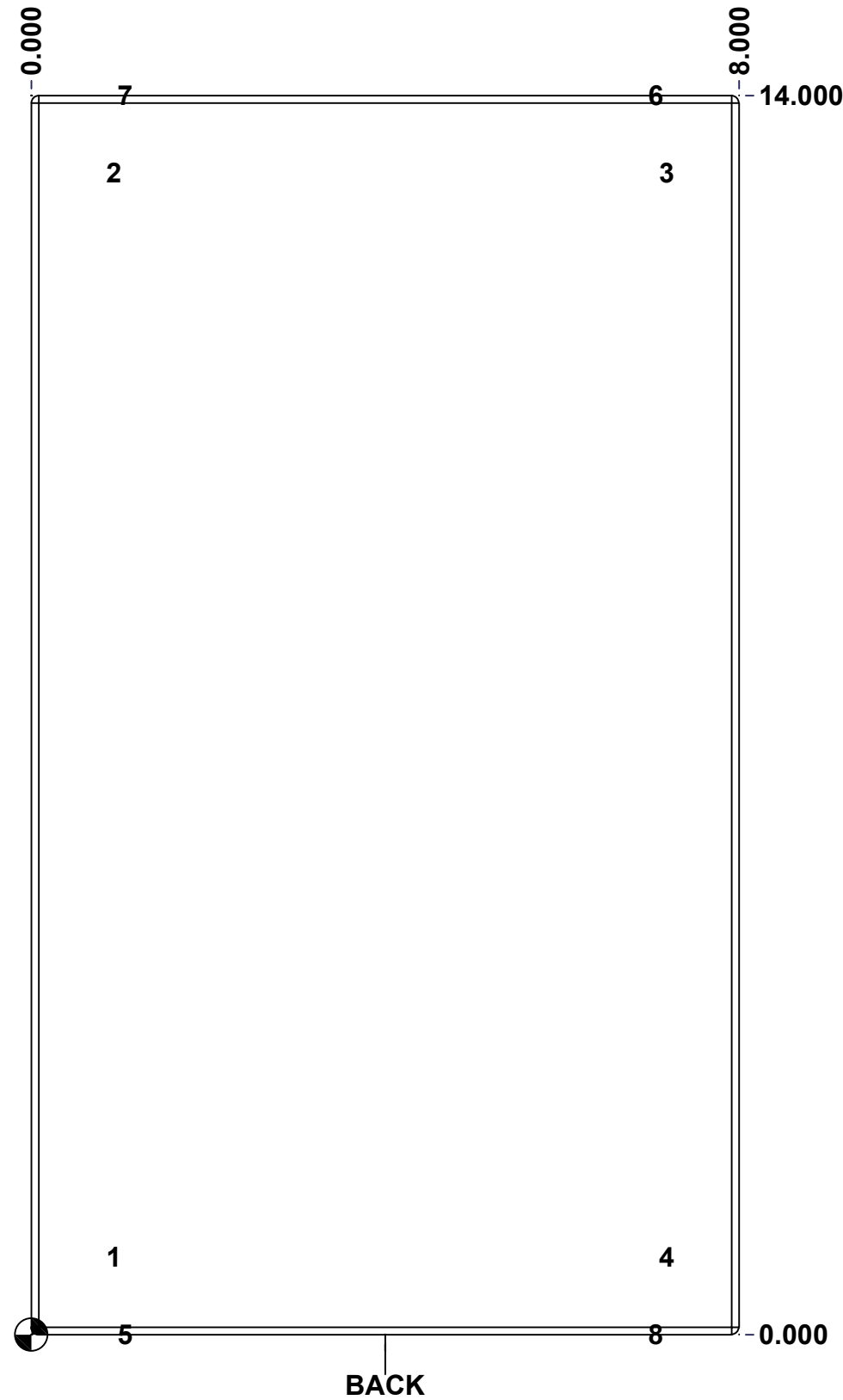

BACK

	Description	Status
	5412ESSMCH 14" x 8" x 6" Body	(NULL)
	Part Number Numéro Pièce	Rev.
	5412ESSMCH1408066NOIPB 0	5 9

This drawing is confidential and must not be reproduced or used without the consent of EXM

Ce dessin est confidentiel et ne doit pas être reproduit ou utilisé sans le consentement de EXM

No.	Revisions	Date	By/Par

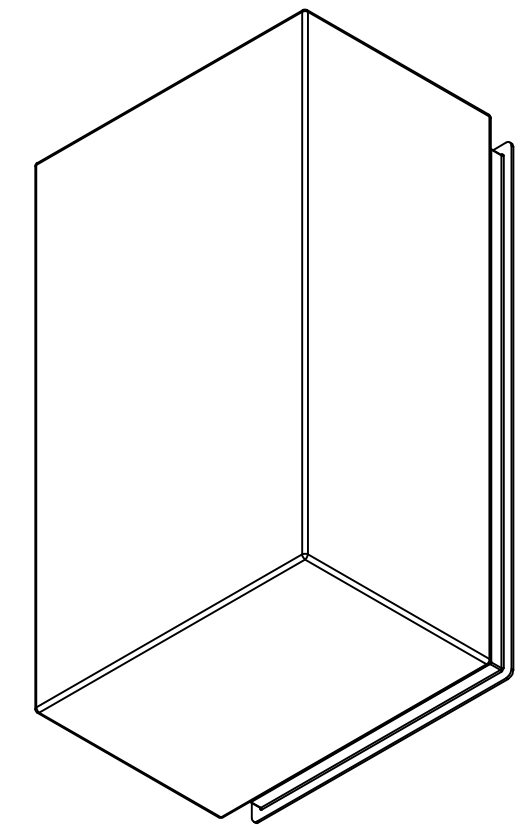

Isometric View

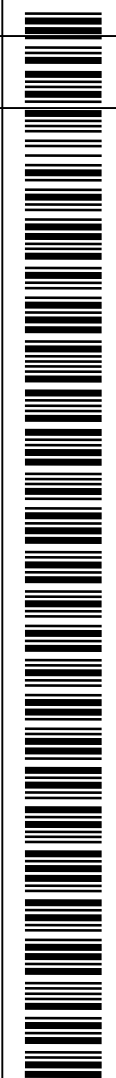

 Tél: (450) 979-4373
 Fax: (450) 979-4626
www.exmweb.com

Flatness:  Max 3.0mm
 Aplatissement:  Max 3.0mm
 Projection: 

Customer Client	Date
Drawn By / Dessiné Par: BoxCad: BoxCad	Date: 13-Mar-23
Material / Matière: 16 Ga Stainless Steel 316 (1.4mm)	

Color / Couleur: Unpainted	Finish / Fini: Brushed
----------------------------	------------------------

Description: 5412ESSMCH 14" x 8" x 6" Body	Detail Rev.
--	-------------

Part Number / Numéro Pièce: 5412ESSMCH1408066NOIPB	Rev. 6
--	--------

Qty	Part Number	Rev	Description
1	5412ESSMCH1408066NO IPB-P	0	5412ESSMCH 14" x 8" x 6" Body Part
2	STK-A-70469	6	5412 ESSMCH - Stainless Steel 316 Body Catch Assembly
2	STK-Q-08100	1	M5 Nylon Insert Lock Nut
5	STK-Q-08500	4	Stainless Steel Standoff M6 x 10mm

Parts List

5412ESSMCH1408066NOIPB 0

This drawing is confidential and must not be reproduced or used without the consent of EXM

Ce dessin est confidentiel et ne doit pas être reproduit ou utilisé sans le consentement de EXM

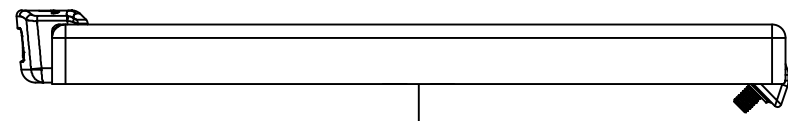

TOP

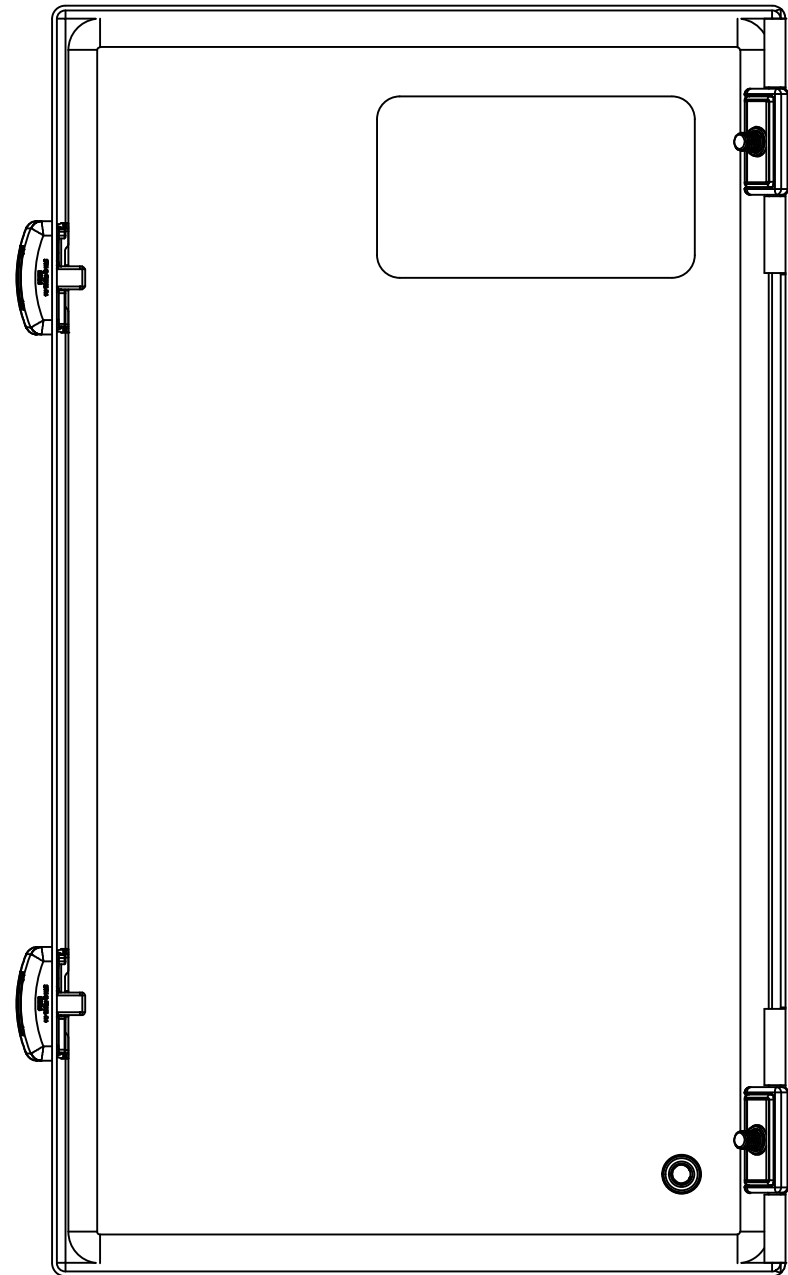

BACK

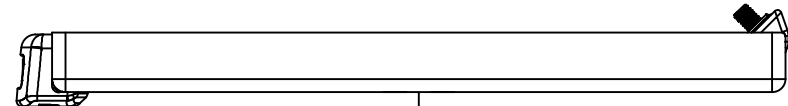

BOTTOM

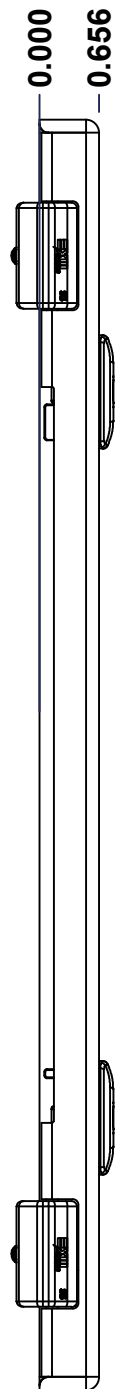

LEFT

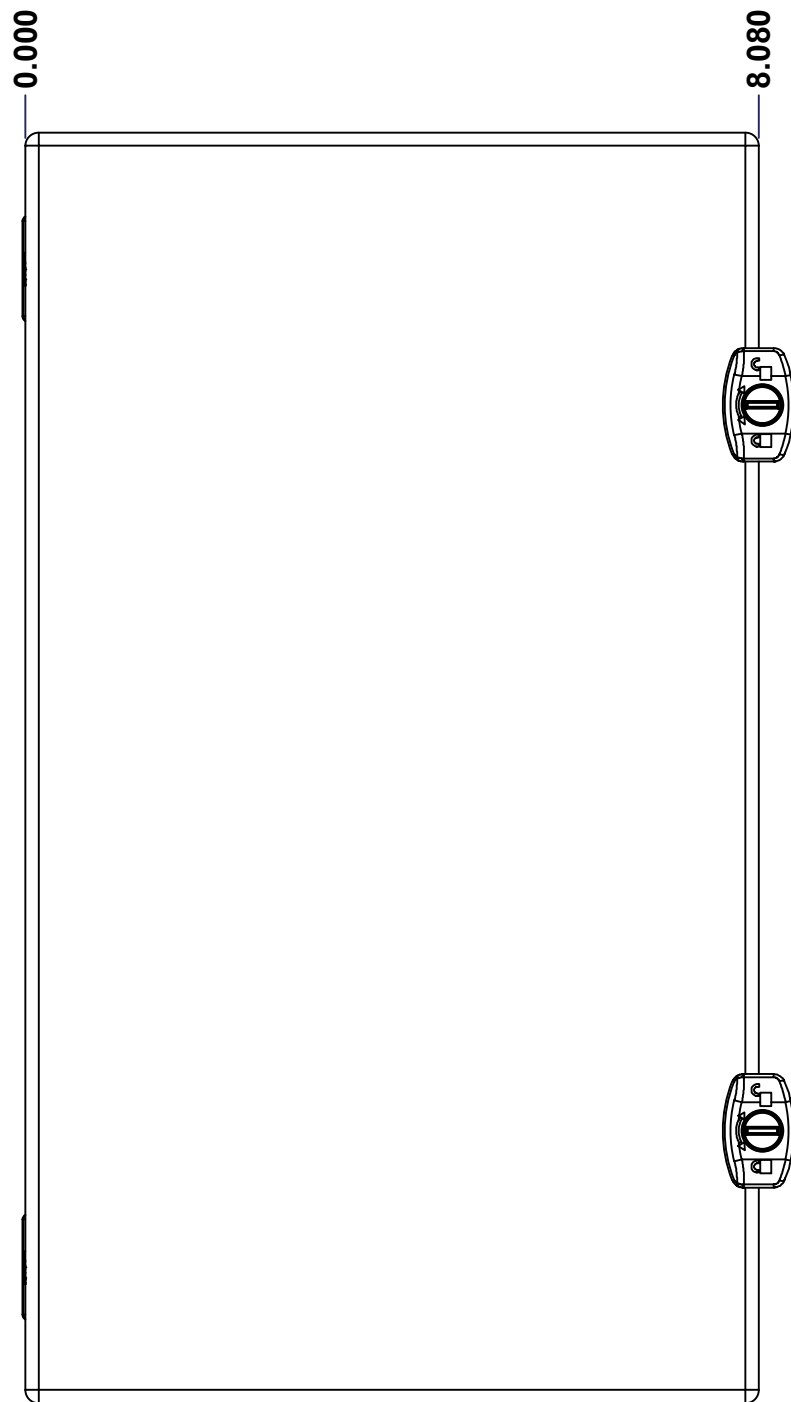

FRONT

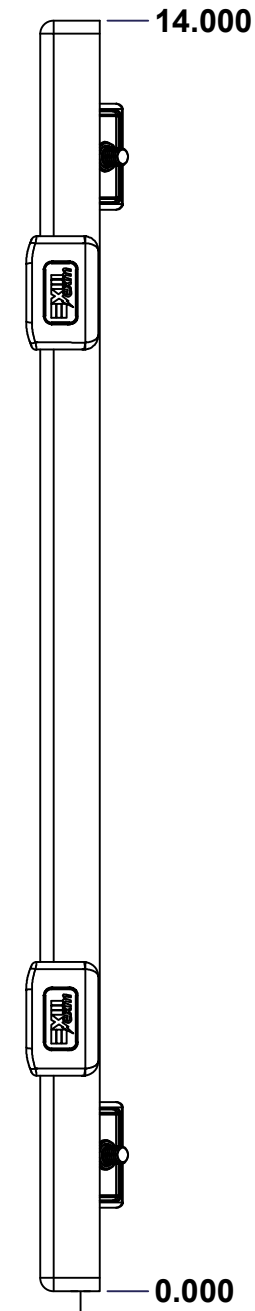

RIGHT

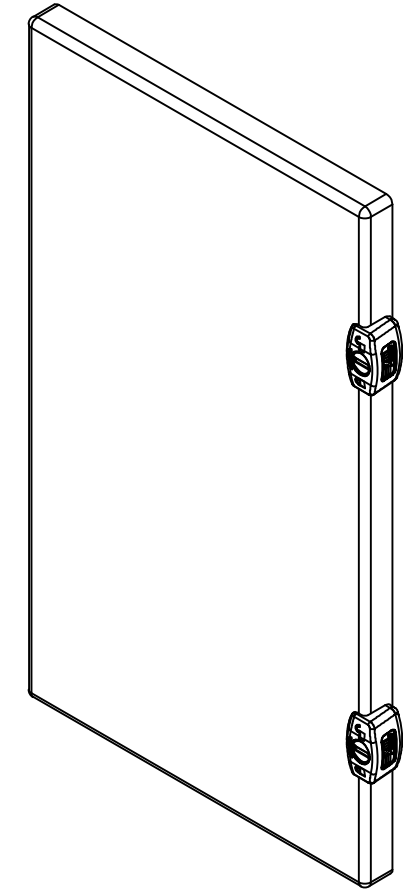

Isometric View



No.	Revisions	Date	By/Par

		Flatness: Aplatissement Max 5.0mm Projection	
Customer Client		Date	
Drawn By / Dessiné Par: BoxCad: BoxCad		Date: 13-Mar-23	
Material / Matière: 16 Ga Stainless Steel 316 (1.4mm)			
Color / Couleur: Unpainted		Finish / Fini: Brushed	
Description: 5412ESSMCH 14" x 8" Cover			Detail Rev.
Part Number / Numéro Pièce: 5412ESSMCH1408066NOIPC			Rev. 7

SEE BILL OF MATERIAL ON LAST PAGE 5412ESSMCH1408066NOIPC 0

This drawing is confidential and must not be reproduced or used without the consent of EXM

Ce dessin est confidentiel et ne doit pas être reproduit ou utilisé sans le consentement de EXM

STANDARD FEATURES ARE NOT LISTED IN THIS HOLE TABLE			
HOLE TABLE - FRONT VIEW (CUSTOM FEATURE ONLY)			
CUT-OUT	XDIM	YDIM	DESCRIPTION
1	1.145	1.125	STANDOFF M6 x 10mm (Inside)
2	2.750	12.000	LABEL_EXM
3	8.080	11.000	LOCK 880 SCQ3MS @ 0.0°
4	8.080	3.000	LOCK 880 SCQ3MS @ 0.0°

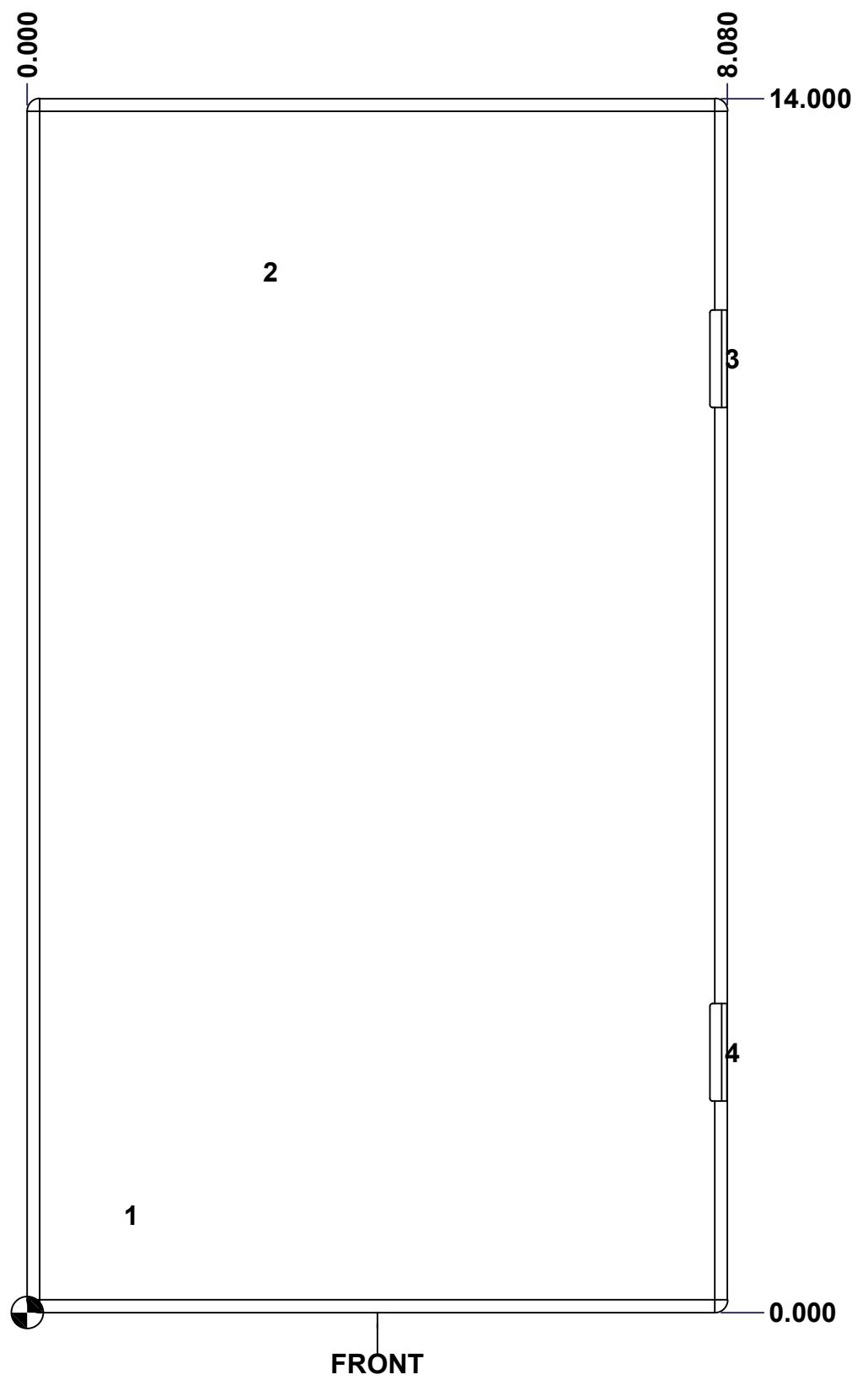

	Description	Status
	5412ESSMCH 14" x 8" Cover	(NULL)
	Part Number Numéro Pièce	Rev.
	5412ESSMCH1408066NOIPC 0	8 9

This drawing is confidential and must not be reproduced or used without the consent of EXM

Ce dessin est confidentiel et ne doit pas être reproduit ou utilisé sans le consentement de EXM

No.	Revisions	Date	By/Par

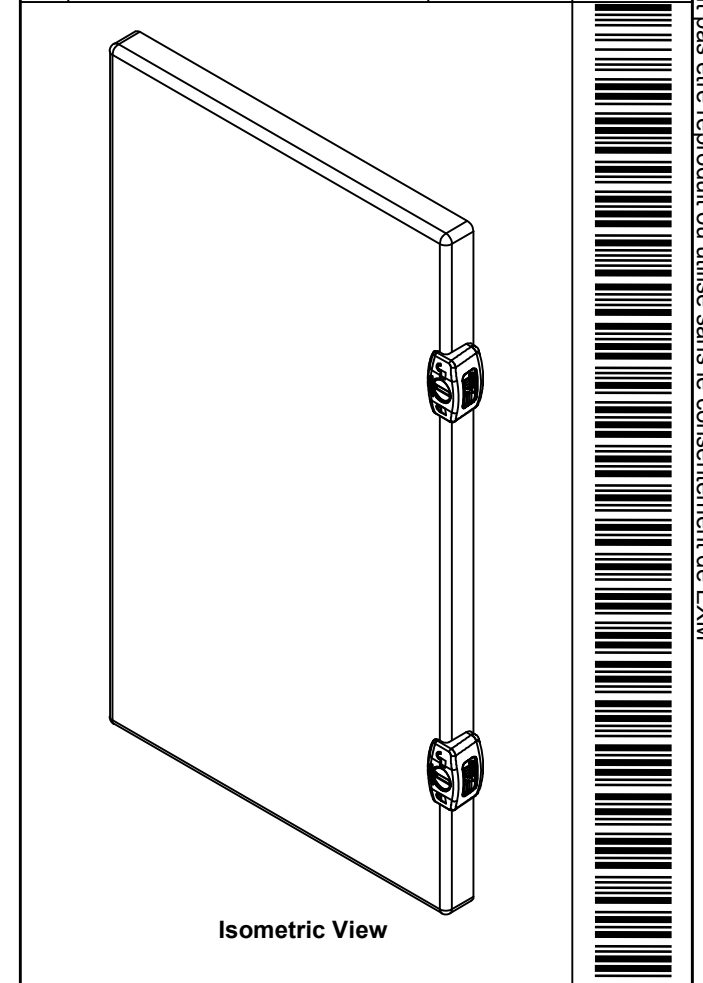

 Tél: (450) 979-4373
 Fax: (450) 979-4626
www.exmweb.com

Flatness:  Max 5.0mm
 Aplatissement:  Max 5.0mm
 Projection: 

Customer Client	Date
Drawn By / Dessiné Par: BoxCad: BoxCad	Date: 13-Mar-23

Material / Matière	16 Ga Stainless Steel 316 (1.4mm)
--------------------	-----------------------------------

Color / Couleur	Unpainted	Finish / Fini	Brushed
-----------------	-----------	---------------	---------

Description	Detail Rev.
5412ESSMCH 14" x 8" Cover	

Part Number / Numéro Pièce	Rev.	9
5412ESSMCH1408066NOIPC 0		9

Qty	Part Number	Rev	Description
1	5412ESSMCH1408066NO IPG	0	5412ESSMCH 14" x 8" Gasket
1	STK-S-00100	0	3.5" x 2" Silver Milar Flexcon Sticker
1	STK-Q-08500	4	Stainless Steel Standoff M6 x 10mm
1	5412ESSMCH1408066NO IPC-P	0	5412ESSMCH 14" x 8" Cover Part
2	STK-A-33038	3	5412 ESSMCH - Stainless Steel Hinge
2	880SCQ3S	4	5412 ESSMCH - Stainless Steel External Lock Assy - Slot Lock
Parts List			