

This drawing is confidential and must not be reproduced or used without the consent of EXM

Ce dessin est confidentiel et ne doit pas être reproduit ou utilisé sans le consentement de EXM

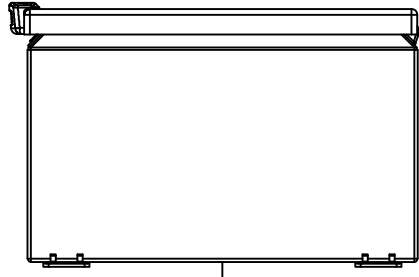

TOP

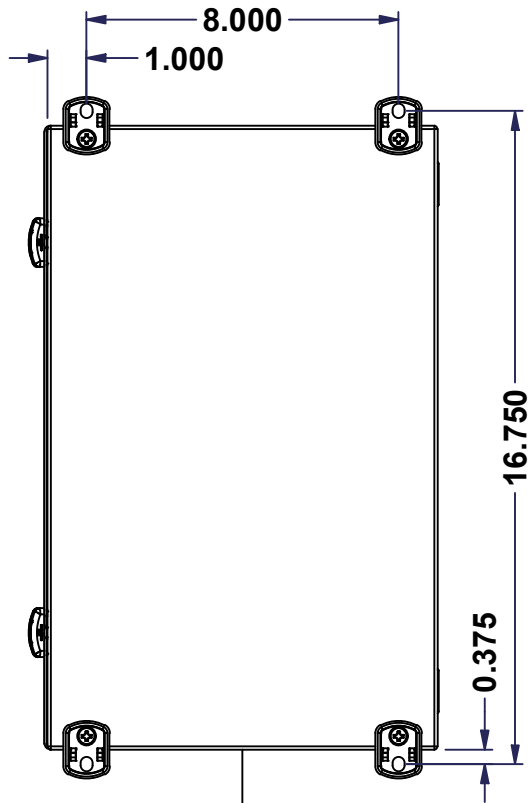

BACK

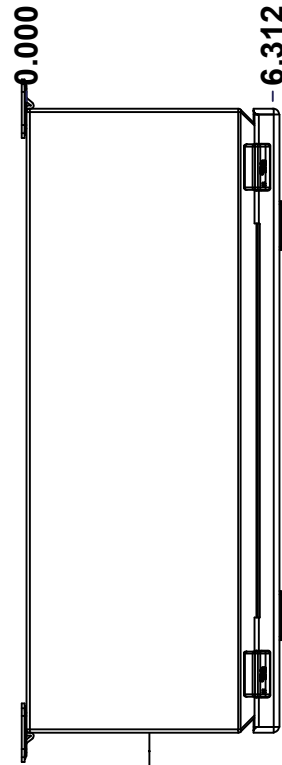

LEFT

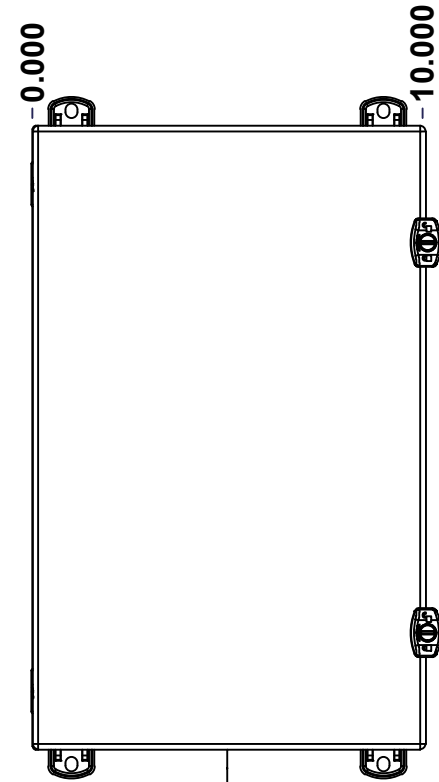

FRONT

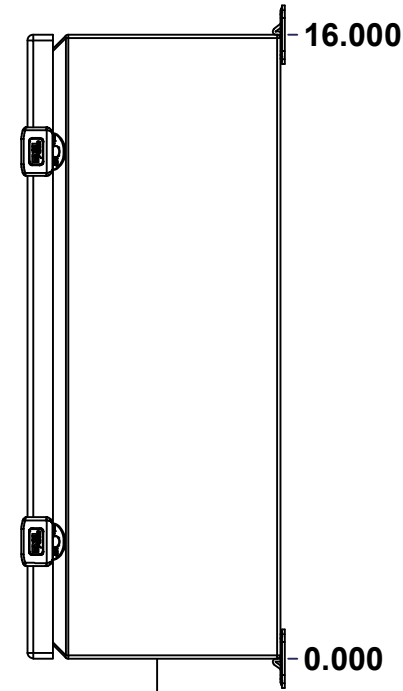

RIGHT

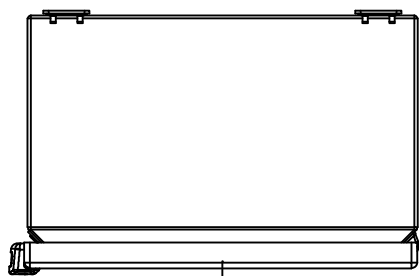

BOTTOM

No.	Revisions	Date	By/Par

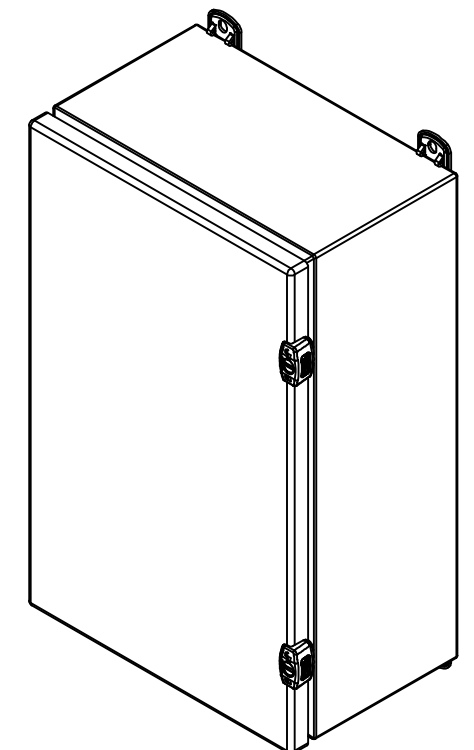

Isometric View



**GRAIN DIRECTION:  
TOP/BOTTOM: HORIZONTAL  
LEFT/RIGHT/BACK/FRONT: VERTICAL**

Tél: (450) 979-4373 Fax: (450) 979-4626 <a href="http://www.exmweb.com">www.exmweb.com</a>		Flatness Aplatissement Max 3.0mm Projection 
Customer Client		Date
Drawn By Dessiné Par	BoxCad: BoxCad	Date 13-Mar-23
Material Matière	16 Ga Stainless Steel 316 (1.4mm)	
Color Couleur	Unpainted	Finish Fini Brushed
Description 5412ESSMCH 16" x 10" x 6" Assembly		Detail Rev.
Part Number Numéro Pièce	5412ESSMCH1610066NOIP	Rev. 1 0

SEE BILL OF MATERIAL ON LAST PAGE

This drawing is confidential and must not be reproduced or used without the consent of EXM

Ce dessin est confidentiel et ne doit pas être reproduit ou utilisé sans le consentement de EXM

NOTE	
ITEM	DESCRIPTION
1	NEMA 4X Enclosure
2	C/W Standard ground standoffs on box and cover
3	W/O Standard door stiffener
4	W/O Inner panel
5	C/W Standard inner panel mounting standoffs
6	C/W 885 ESCHMF2 Mounting Feet (Kit)

No.	Revisions	Date	By/Par

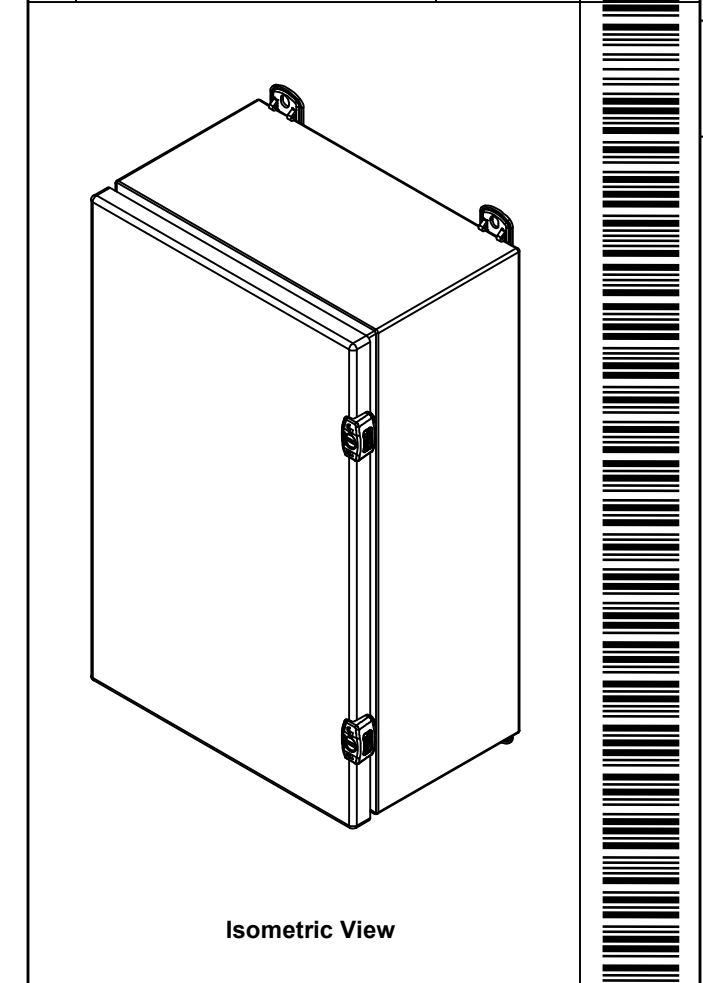

	Tél: (450) 979-4373 Fax: (450) 979-4626 <a href="http://www.exmweb.com">www.exmweb.com</a>	Flatness Aplatissement Max 3.0mm
		Projection 
Customer Client	Date	
Drawn By Dessiné Par	BoxCad: BoxCad	Date 13-Mar-23
Material Matière	16 Ga Stainless Steel 316 (1.4mm)	
Color Couleur	Unpainted	Finish Fini Brushed
Description	5412ESSMCH 16" x 10" x 6" Assembly	
Part Number Numéro Pièce	5412ESSMCH1610066NOIP	Rev. 0

PACKING		
ITEM	QTY	DESCRIPTION
STK-E-04325	1	CARTON 5412 ESCH161006
Plastic bag	1	To protect cover surface and inside gasket
Packaging label	1	White label with product number
STK-S-01100	1	ESCH EXM SQUARE STICKER

Qty	Part Number	Rev	Description
1	STK-K-02945	0	5412 ESSMCH Accessory Kit
1	5412ESSMCH1610066NO IPC	0	5412ESSMCH 16" x 10" Cover
1	5412ESSMCH1610066NO IPB	0	5412ESSMCH 16" x 10" x 6" Body
2	STK-Q-08100	1	M5 Nylon Insert Lock Nut
2	STK-Q-10249	0	M5 Sealing Washer

Parts List

This drawing is confidential and must not be reproduced or used without the consent of EXM

Ce dessin est confidentiel et ne doit pas être reproduit ou utilisé sans le consentement de EXM

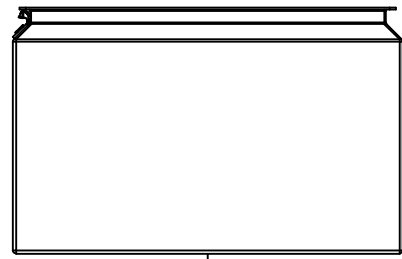

TOP

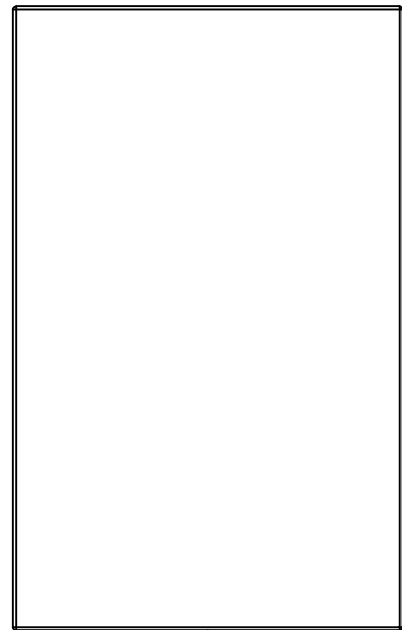

BACK

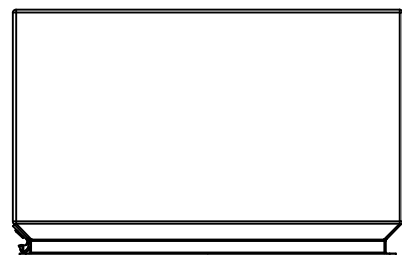

BOTTOM

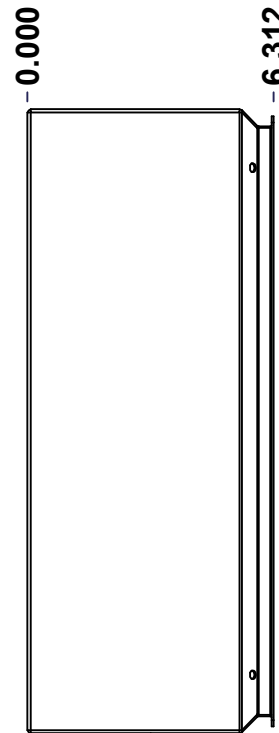

LEFT

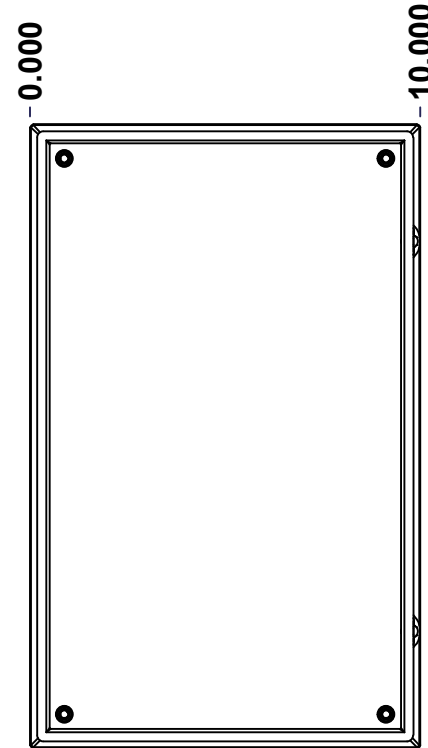

FRONT

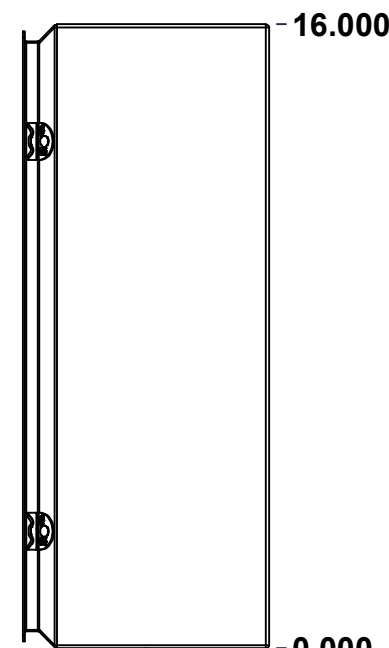

RIGHT

No.	Revisions	Date	By/Par

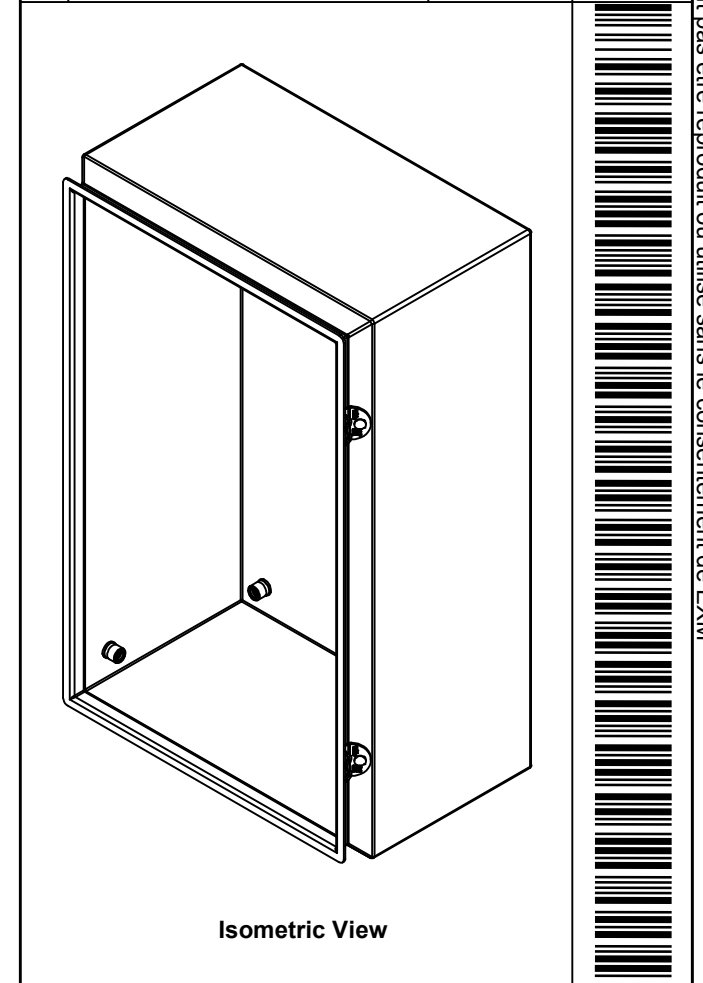

Isometric View

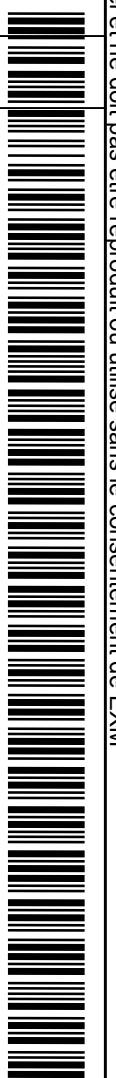

 Tél: (450) 979-4373 Fax: (450) 979-4626 <a href="http://www.exmweb.com">www.exmweb.com</a>		Flatness Aplatissement Max 5.0mm Projection
Customer Client	Date	
Drawn By Dessiné Par	BoxCad: BoxCad	Date 13-Mar-23
Material Matière	16 Ga Stainless Steel 316 (1.4mm)	
Color Couleur	Unpainted	Finish Fini Brushed
Description	Detail Rev.	
5412ESSMCH 16" x 10" x 6" Body		
Part Number Numéro Pièce	Rev.	3
		9

SEE BILL OF MATERIAL ON LAST PAGE 5412ESSMCH1610066NOIPB 0

This drawing is confidential and must not be reproduced or used without the consent of EXM

Ce dessin est confidentiel et ne doit pas être reproduit ou utilisé sans le consentement de EXM

STANDARD FEATURES ARE NOT LISTED IN THIS HOLE TABLE			
HOLE TABLE - LEFT VIEW (CUSTOM FEATURE ONLY)			
CUT-OUT	XDIM	YDIM	DESCRIPTION
1	4.625	0.875	STANDOFF M6 x 10mm (Inside)

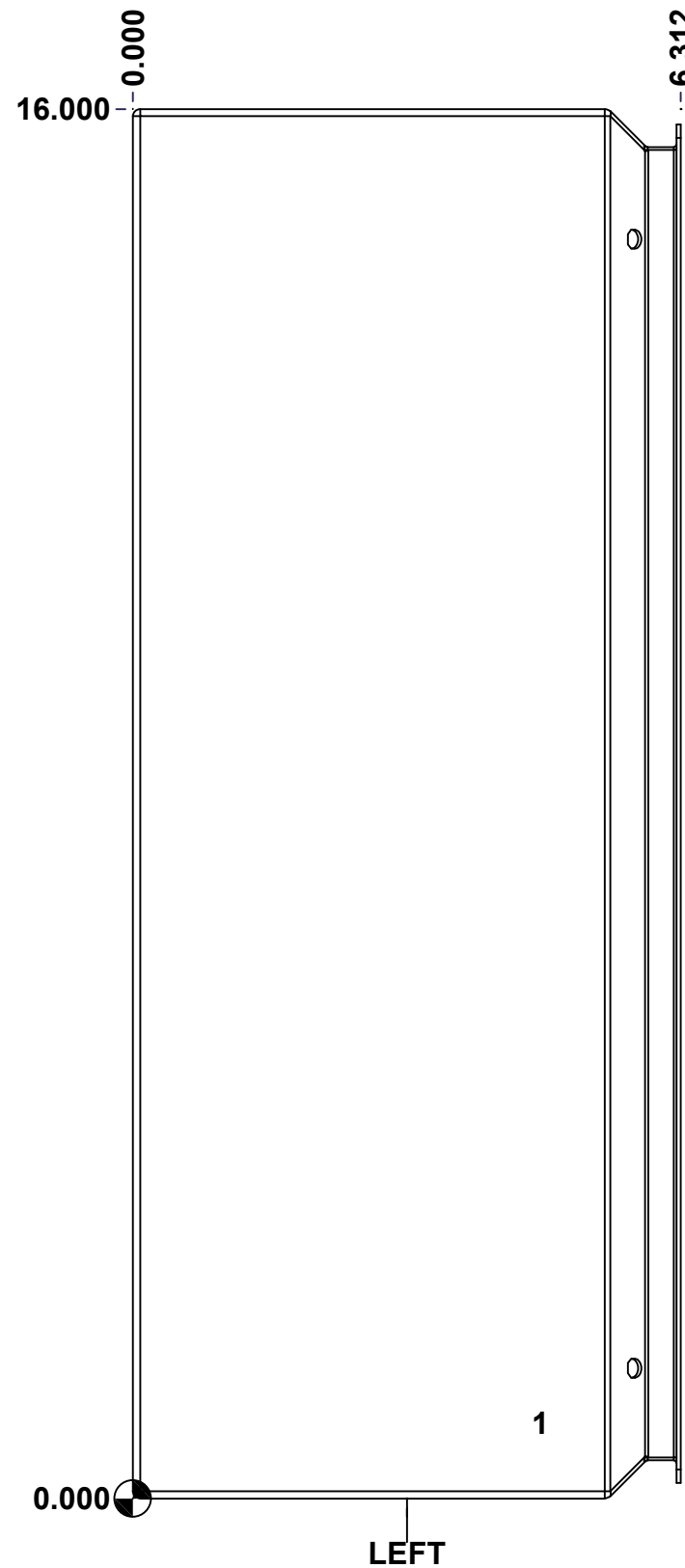

	Description	Status
	5412ESSMCH 16" x 10" x 6" Body	(NULL)
	Part Number Numéro Pièce	Rev.
	<b>5412ESSMCH1610066NOIPB 0</b>	4 9

This drawing is confidential and must not be reproduced or used without the consent of EXM

Ce dessin est confidentiel et ne doit pas être reproduit ou utilisé sans le consentement de EXM

**STANDARD FEATURES ARE NOT LISTED IN THIS HOLE TABLE**

**HOLE TABLE - BACK VIEW (CUSTOM FEATURE ONLY)**

CUT-OUT	XDIM	YDIM	DESCRIPTION
1	0.875	0.875	IP STANDOFF M6 x 10mm (Inside)
2	0.875	15.125	IP STANDOFF M6 x 10mm (Inside)
3	9.125	15.125	IP STANDOFF M6 x 10mm (Inside)
4	9.125	0.875	IP STANDOFF M6 x 10mm (Inside)
-----			
5	9.000	0.000	FOOT 885 ESCHMF2
6	1.000	0.000	FOOT 885 ESCHMF2
7	9.000	16.000	FOOT 885 ESCHMF2
8	1.000	16.000	FOOT 885 ESCHMF2

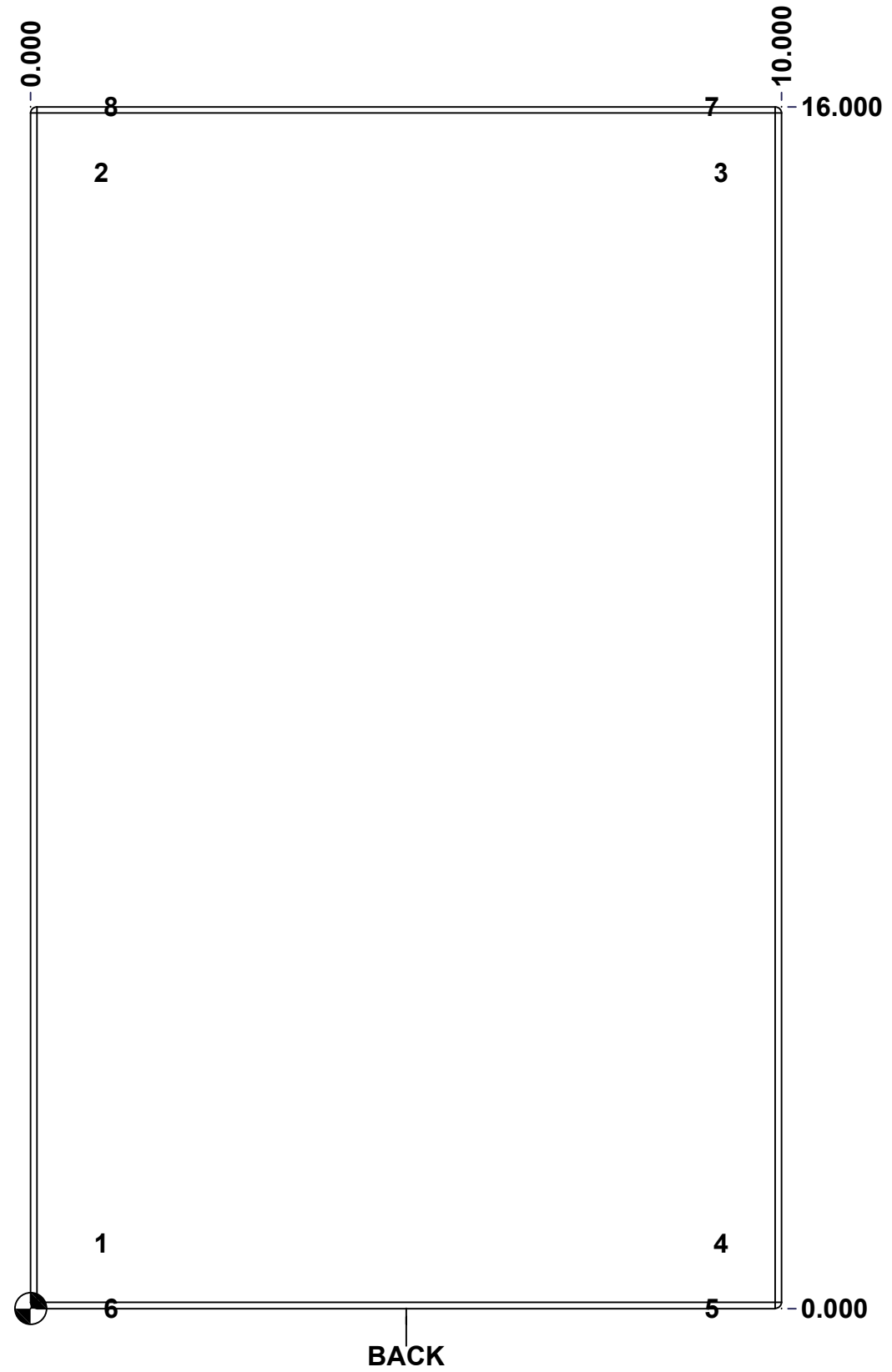

BACK

	Description	Status
	5412ESSMCH 16" x 10" x 6" Body	(NULL)
	Part Number Numéro Pièce	Rev.
	<b>5412ESSMCH1610066NOIPB 0</b>	5 9

This drawing is confidential and must not be reproduced or used without the consent of EXM

Ce dessin est confidentiel et ne doit pas être reproduit ou utilisé sans le consentement de EXM

No.	Revisions	Date	By/Par

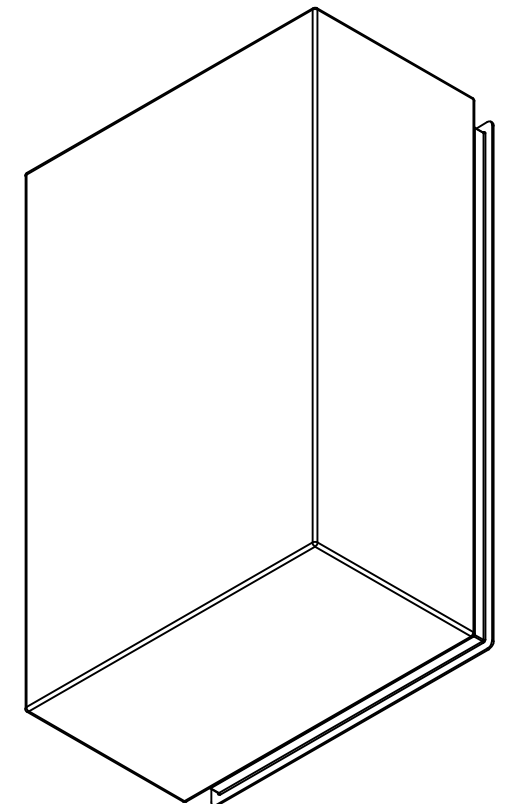

Isometric View



Tél: (450) 979-4373  
 Fax: (450) 979-4626  
[www.exmweb.com](http://www.exmweb.com)

Flatness  
 Aplatissement  
 Max 3.0mm  
 Projection

Customer Client	Date
Drawn By / Dessiné Par: BoxCad: BoxCad	Date: 13-Mar-23
Material / Matière: 16 Ga Stainless Steel 316 (1.4mm)	

Color / Couleur: Unpainted	Finish / Fini: Brushed
----------------------------	------------------------

Description: 5412ESSMCH 16" x 10" x 6" Body	Detail Rev.
---	-------------

Part Number / Numéro Pièce: 5412ESSMCH1610066NOIPB	Rev. 6
--	--------

Qty	Part Number	Rev	Description
1	5412ESSMCH1610066NO IPB-P	0	5412ESSMCH 16" x 10" x 6" Body Part
2	STK-A-70469	6	5412 ESSMCH - Stainless Steel 316 Body Catch Assembly
2	STK-Q-08100	1	M5 Nylon Insert Lock Nut
5	STK-Q-08500	4	Stainless Steel Standoff M6 x 10mm

Parts List

**5412ESSMCH1610066NOIPB 0**

This drawing is confidential and must not be reproduced or used without the consent of EXM

Ce dessin est confidentiel et ne doit pas être reproduit ou utilisé sans le consentement de EXM

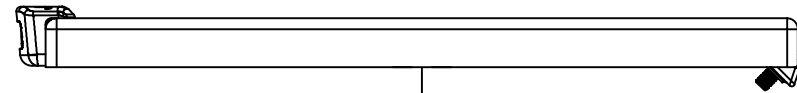

TOP

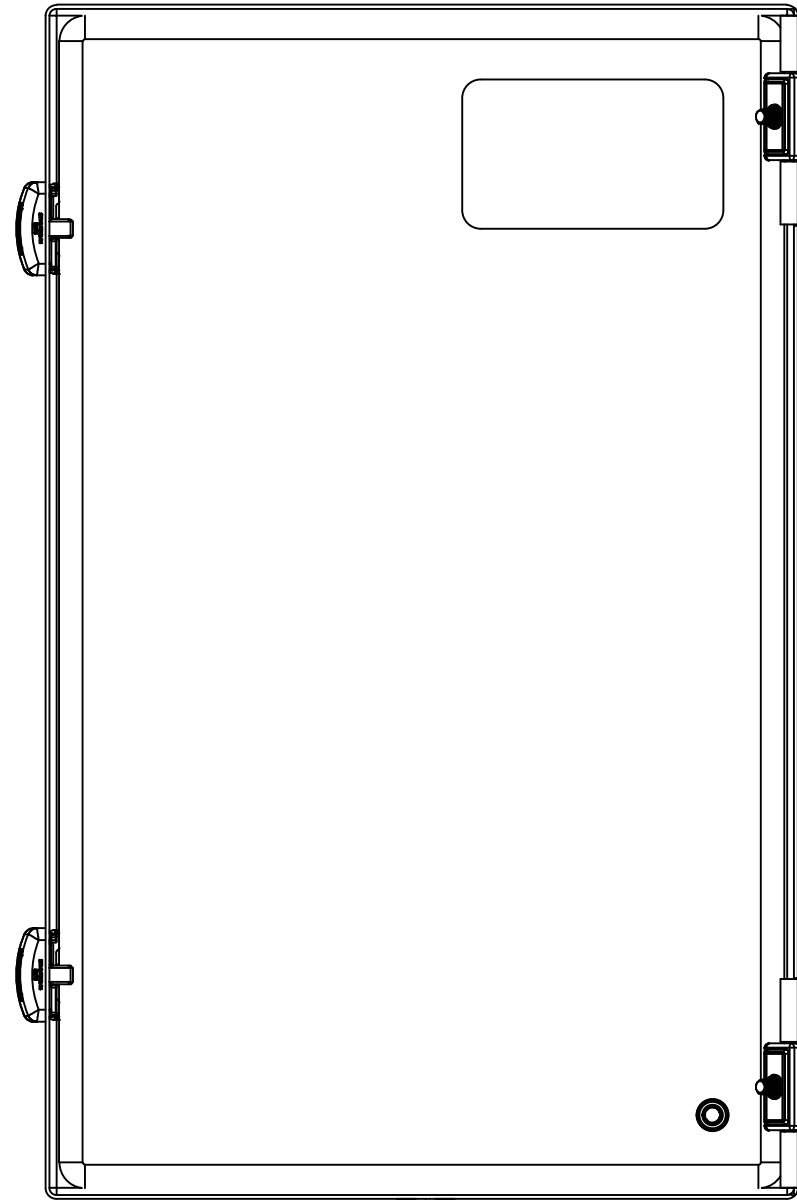

BACK

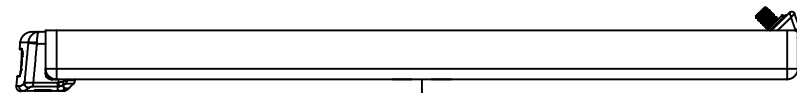

BOTTOM

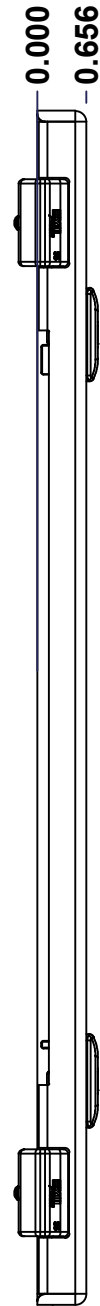

LEFT

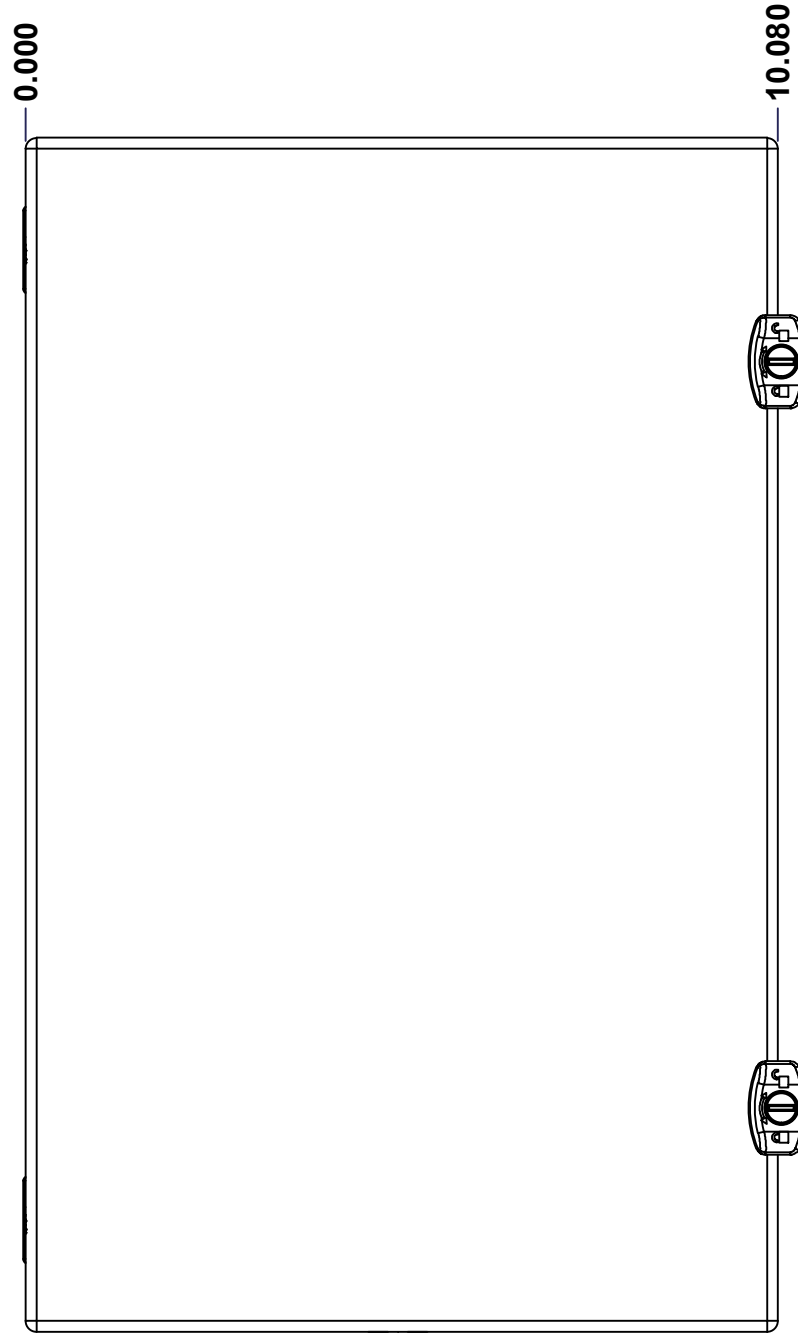

FRONT

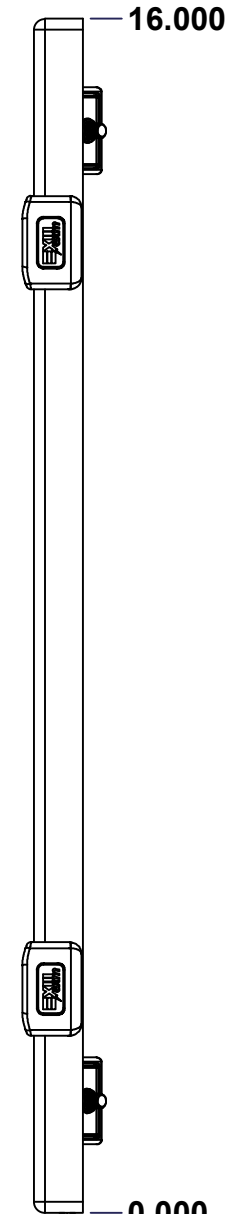

RIGHT

No.	Revisions	Date	By/Par

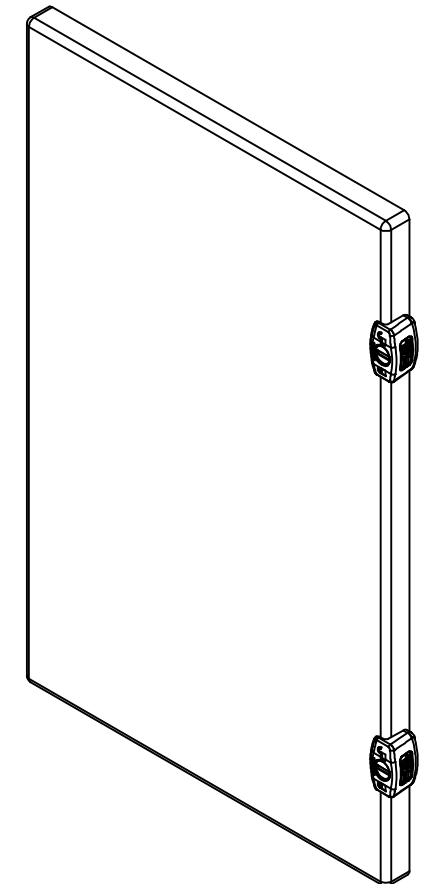

Isometric View



Tél: (450) 979-4373  
 Fax: (450) 979-4626  
[www.exmweb.com](http://www.exmweb.com)

Flatness  
Aplatissement  
Max 5.0mm  
Projection

Customer Client	Date
Drawn By Dessiné Par BoxCad: BoxCad	Date 13-Mar-23
Material Matière 16 Ga Stainless Steel 316 (1.4mm)	
Color Couleur Unpainted	Finish Fini Brushed
Description 5412ESSMCH 16" x 10" Cover	Detail Rev.
Part Number Numéro Pièce	Rev. 7

SEE BILL OF MATERIAL ON LAST PAGE 5412ESSMCH1610066NOIPC 0

This drawing is confidential and must not be reproduced or used without the consent of EXM

Ce dessin est confidentiel et ne doit pas être reproduit ou utilisé sans le consentement de EXM

STANDARD FEATURES ARE NOT LISTED IN THIS HOLE TABLE			
HOLE TABLE - FRONT VIEW (CUSTOM FEATURE ONLY)			
CUT-OUT	XDIM	YDIM	DESCRIPTION
1	1.145	1.125	STANDOFF M6 x 10mm (Inside)
2	2.750	14.000	LABEL_EXM
3	10.080	13.000	LOCK 880 SCQ3MS @ 0.0°
4	10.080	3.000	LOCK 880 SCQ3MS @ 0.0°

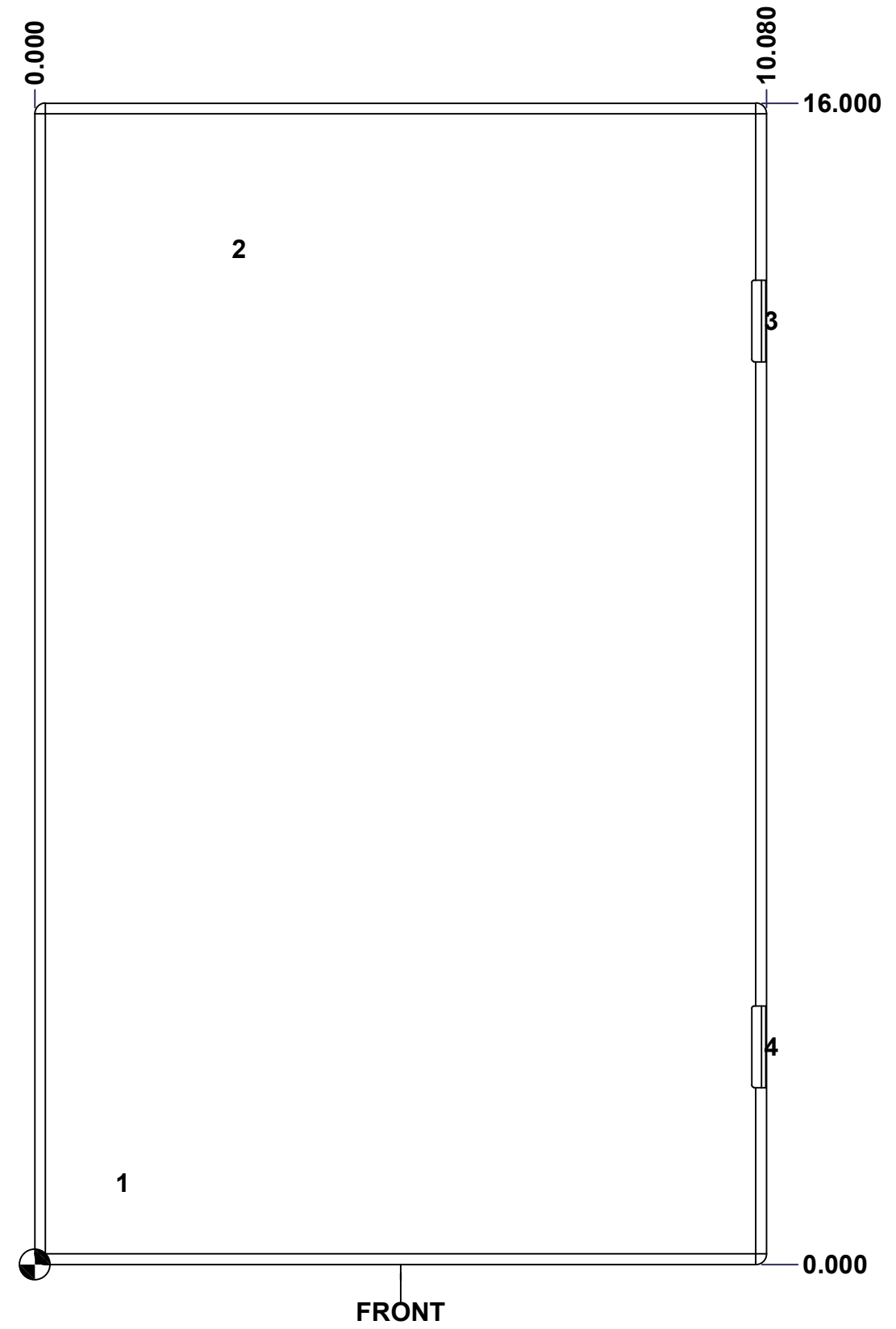

	Description	Status
	5412ESSMCH 16" x 10" Cover	(NULL)
	Part Number Numéro Pièce	Rev.
	<b>5412ESSMCH1610066NOIPC 0</b>	8 9



This drawing is confidential and must not be reproduced or used without the consent of EXM

Ce dessin est confidentiel et ne doit pas être reproduit ou utilisé sans le consentement de EXM

No.	Revisions	Date	By/Par

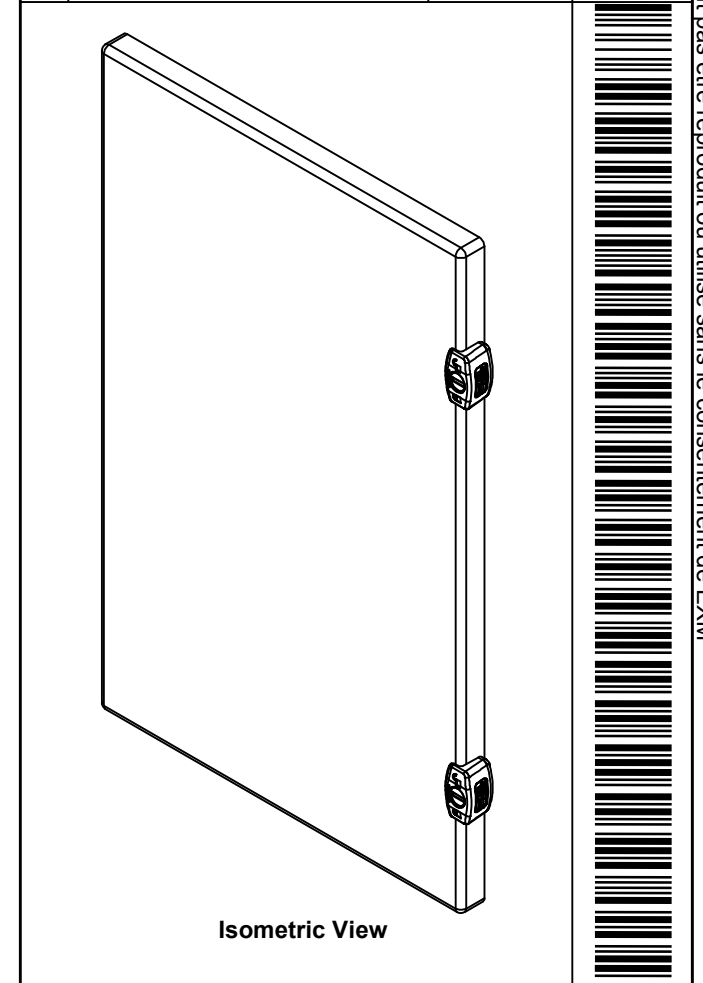

 Tél: (450) 979-4373  
 Fax: (450) 979-4626  
[www.exmweb.com](http://www.exmweb.com)

Flatness:  Max 5.0mm  
 Aplatissement:  Max 5.0mm  
 Projection: 

Customer Client	Date
Drawn By / Dessiné Par: BoxCad: BoxCad	Date: 13-Mar-23

Material / Matière	16 Ga Stainless Steel 316 (1.4mm)
--------------------	-----------------------------------

Color / Couleur	Unpainted	Finish / Fini	Brushed
-----------------	-----------	---------------	---------

Description	Detail Rev.
5412ESSMCH 16" x 10" Cover	

Part Number / Numéro Pièce	Rev.	9
<b>5412ESSMCH1610066NOIPC</b>	<b>0</b>	<b>9</b>

Qty	Part Number	Rev	Description
1	5412ESSMCH1610066NO IPG	0	5412ESSMCH 16" x 10" Gasket
1	STK-S-00100	0	3.5" x 2" Silver Milar Flexcon Sticker
1	STK-Q-08500	4	Stainless Steel Standoff M6 x 10mm
1	5412ESSMCH1610066NO IPC-P	0	5412ESSMCH 16" x 10" Cover Part
2	STK-A-33038	3	5412 ESSMCH - Stainless Steel Hinge
2	880SCQ3S	4	5412 ESSMCH - Stainless Steel External Lock Assy - Slot Lock
Parts List			