

This drawing is confidential and must not be reproduced or used without the consent of EXM

Ce dessin est confidentiel et ne doit pas être reproduit ou utilisé sans le consentement de EXM

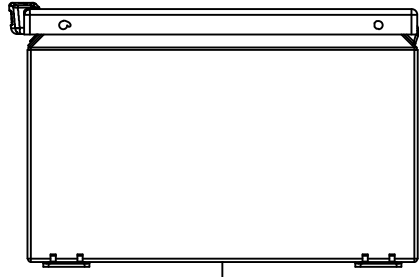

TOP

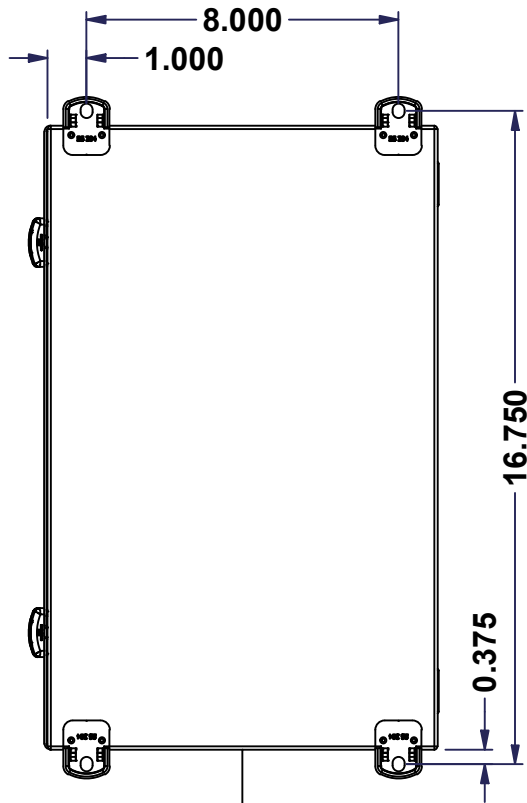

BACK

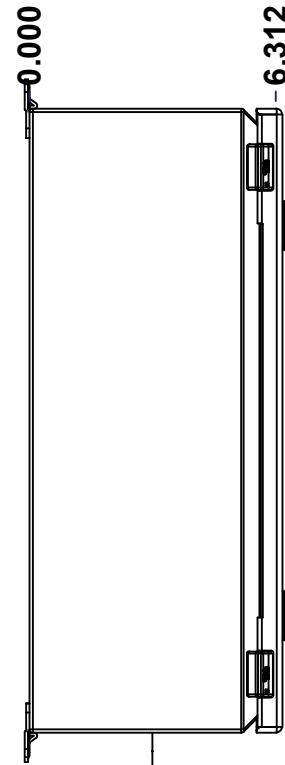

LEFT

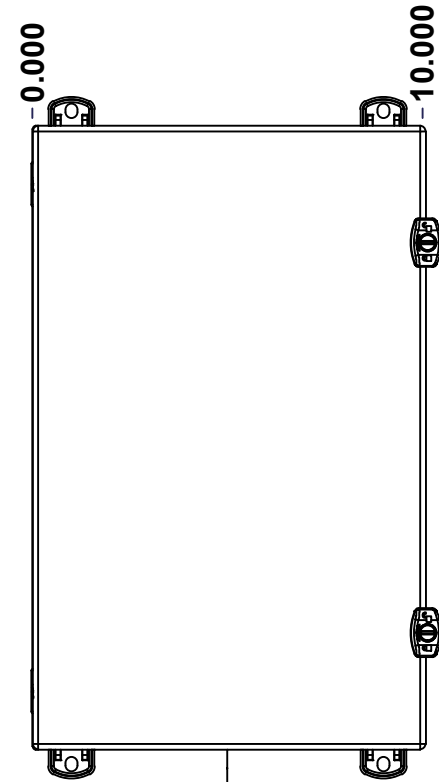

FRONT

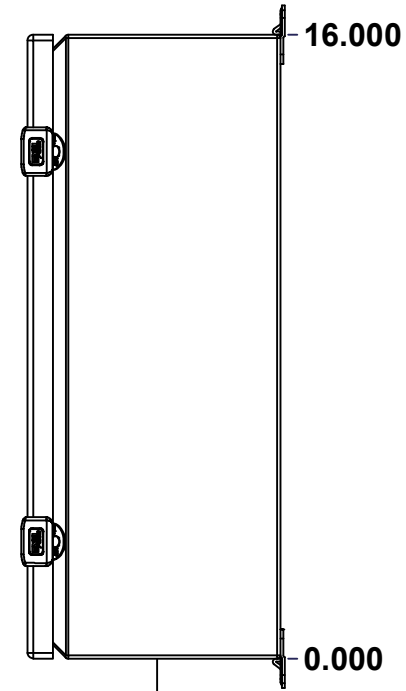

RIGHT

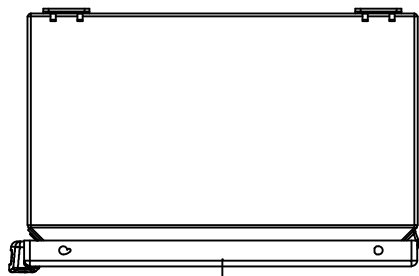

BOTTOM

No.	Revisions	Date	By/Par

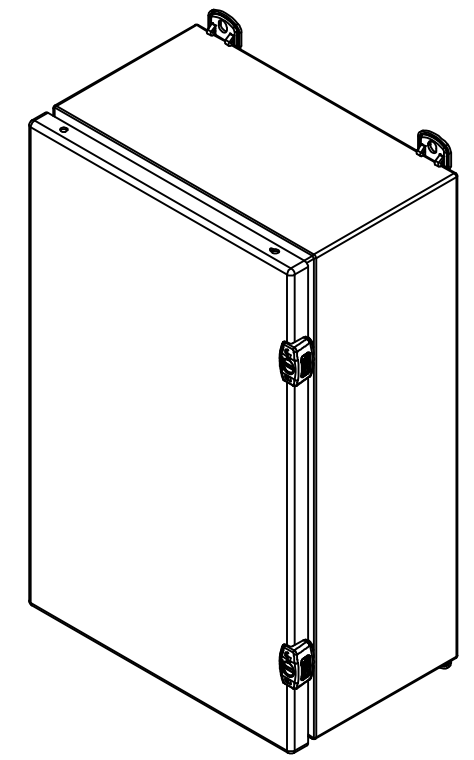

Isometric View



Tél: (450) 979-4373
 Fax: (450) 979-4626
www.exmweb.com

Flatness
Aplatissement
Max 3.0mm
Projection

Customer Client	Date
Drawn By Dessiné Par BoxCad: BoxCad	Date 13-Mar-23
Material Matière 16 Ga Stainless Steel 316 (1.4mm)	
Color Couleur Asa-61 Grey	Finish Fini Smooth
Description 5412ESSMPCH 16" x 10" x 6" Assembly	Detail Rev.
Part Number Numéro Pièce 5412ESSMPCH1610066	Rev. 1 0

SEE BILL OF MATERIAL ON LAST PAGE

This drawing is confidential and must not be reproduced or used without the consent of EXM

Ce dessin est confidentiel et ne doit pas être reproduit ou utilisé sans le consentement de EXM

NOTE	
ITEM	DESCRIPTION
1	NEMA 4X Enclosure
2	C/W Standard ground standoffs on box and cover
3	W/O Standard door stiffener
4	C/W Standard inner panel (Included)
5	C/W Standard inner panel mounting standoffs
6	C/W 885 ESCHMF2 Mounting Feet (Welded)

No.	Revisions	Date	By/Par

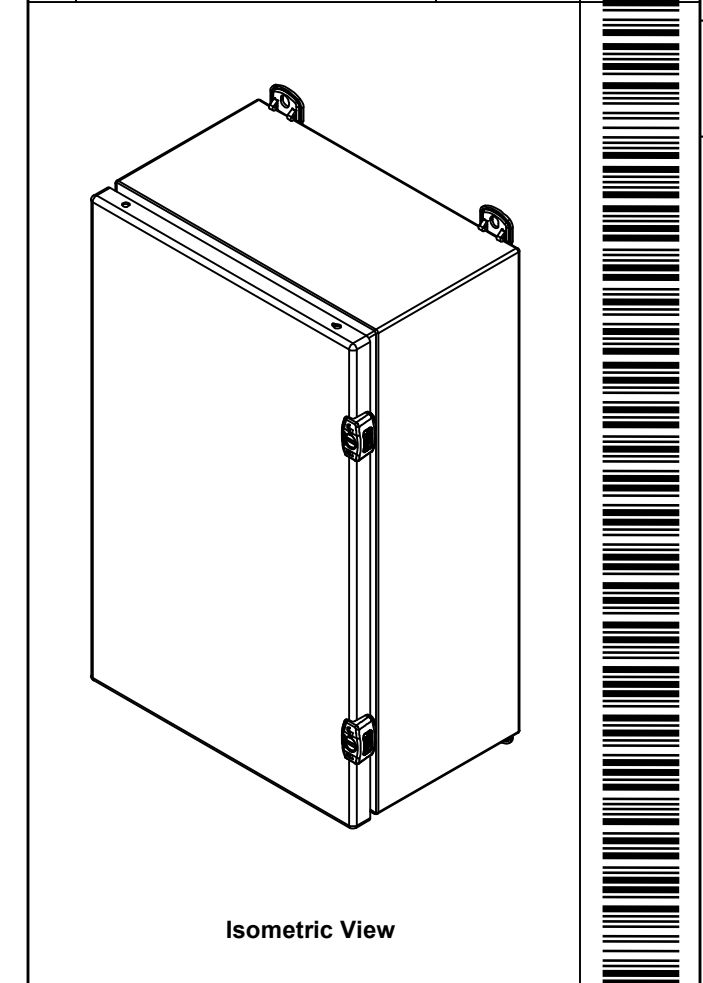

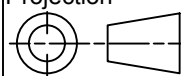
 Tél: (450) 979-4373 Fax: (450) 979-4626 www.exmweb.com	Flatness Aplatissement Max 3.0mm
	Projection 
Customer Client	Date
Drawn By Dessiné Par BoxCad: BoxCad	Date 13-Mar-23
Material Matière 16 Ga Stainless Steel 316 (1.4mm)	
Color Couleur Asa-61 Grey	Finish Fini Smooth
Description 5412ESSMPCH 16" x 10" x 6" Assembly	Detail Rev.
Part Number Numéro Pièce 5412ESSMPCH1610066	Rev. 0

PACKING		
ITEM	QTY	DESCRIPTION
STK-E-04325	1	CARTON 5412 ESCH161006
Plastic bag	1	To protect cover surface and inside gasket
Packaging label	1	White label with product number
STK-S-01100	1	ESCH EXM SQUARE STICKER

Qty	Part Number	Rev	Description
1	5412ESSMPCH1610066C	0	5412ESSMPCH 16" x 10" Cover
1	880 SP1610G	0	880 SP1610G - Inner Panel
1	STK-K-02910	3	5412 ESCH Accessory Kit
1	5412ESSMPCH1610066B	0	5412ESSMPCH 16" x 10" x 6" Body
2	STK-Q-08100	1	M5 Nylon Insert Lock Nut
2	STK-Q-10249	0	M5 Sealing Washer

Parts List

This drawing is confidential and must not be reproduced or used without the consent of EXM

Ce dessin est confidentiel et ne doit pas être reproduit ou utilisé sans le consentement de EXM

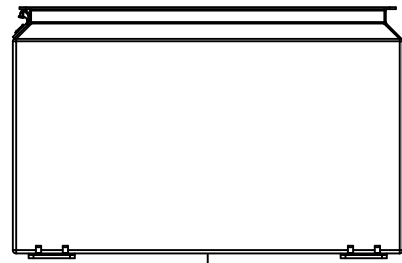

TOP

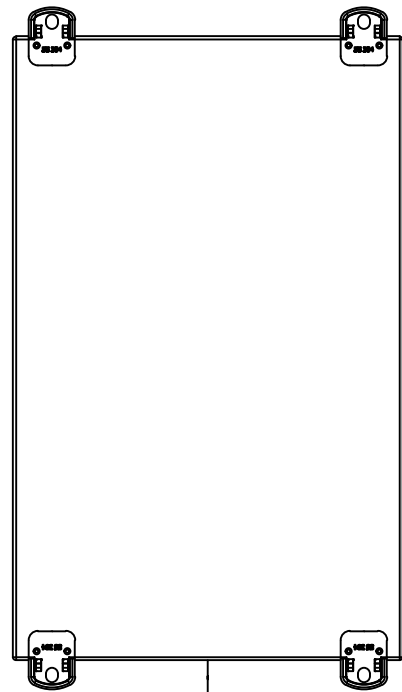

BACK

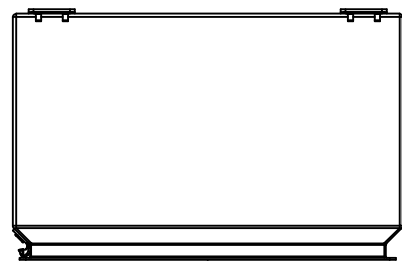

BOTTOM

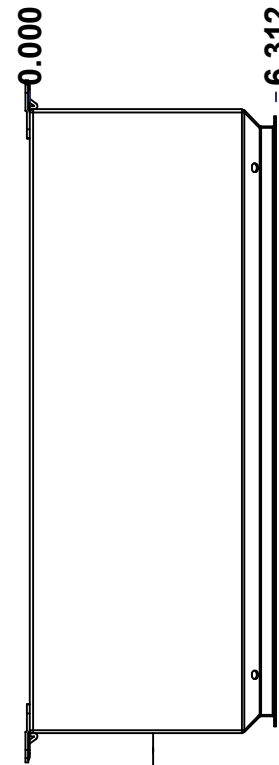

LEFT

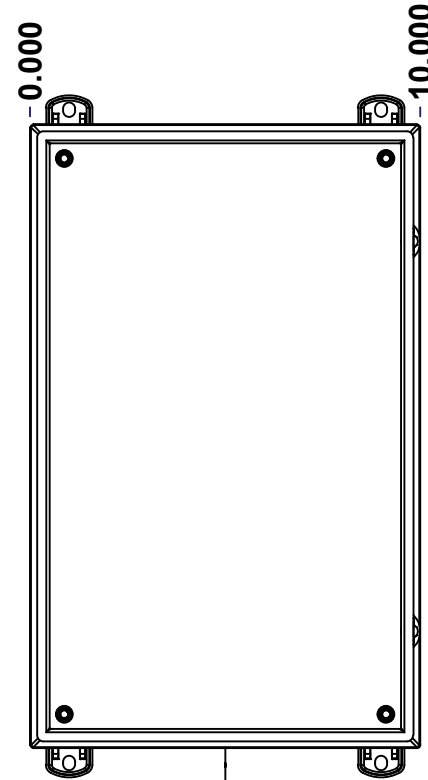

FRONT

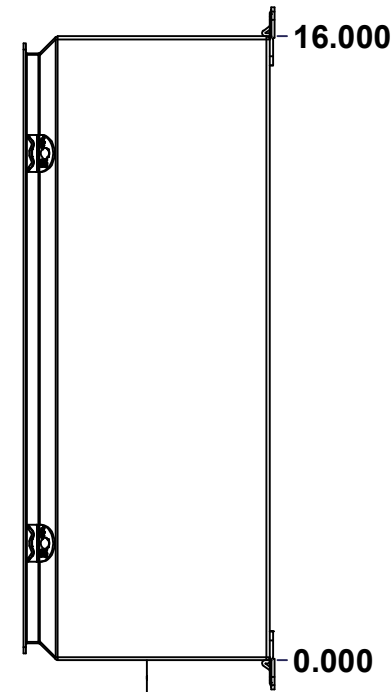

RIGHT

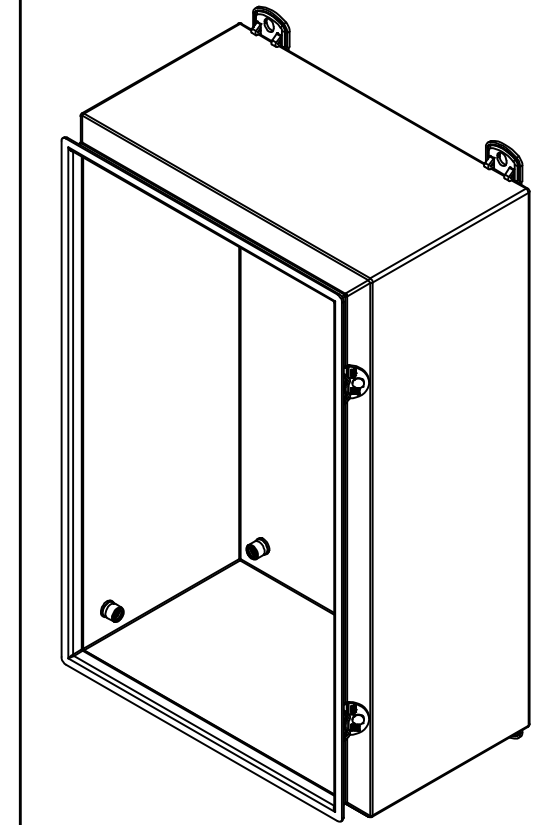

Isometric View

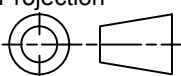

No.	Revisions	Date	By/Par

 Tél: (450) 979-4373 Fax: (450) 979-4626 www.exmweb.com		Flatness Aplatissement Max 3.0mm Projection 
Customer Client	Date	
Drawn By Dessiné Par	BoxCad: BoxCad	Date 13-Mar-23
Material Matière	16 Ga Stainless Steel 316 (1.4mm)	
Color Couleur	Asa-61 Grey	Finish Fini Smooth
Description	Detail Rev.	
5412ESSMPCH 16" x 10" x 6" Body		
Part Number Numéro Pièce	Rev. 0	3 9
5412ESSMPCH1610066B		

SEE BILL OF MATERIAL ON LAST PAGE

This drawing is confidential and must not be reproduced or used without the consent of EXM

Ce dessin est confidentiel et ne doit pas être reproduit ou utilisé sans le consentement de EXM

STANDARD FEATURES ARE NOT LISTED IN THIS HOLE TABLE			
HOLE TABLE - LEFT VIEW (CUSTOM FEATURE ONLY)			
CUT-OUT	XDIM	YDIM	DESCRIPTION
1	4.625	0.875	STANDOFF M6 x 10mm (Inside)

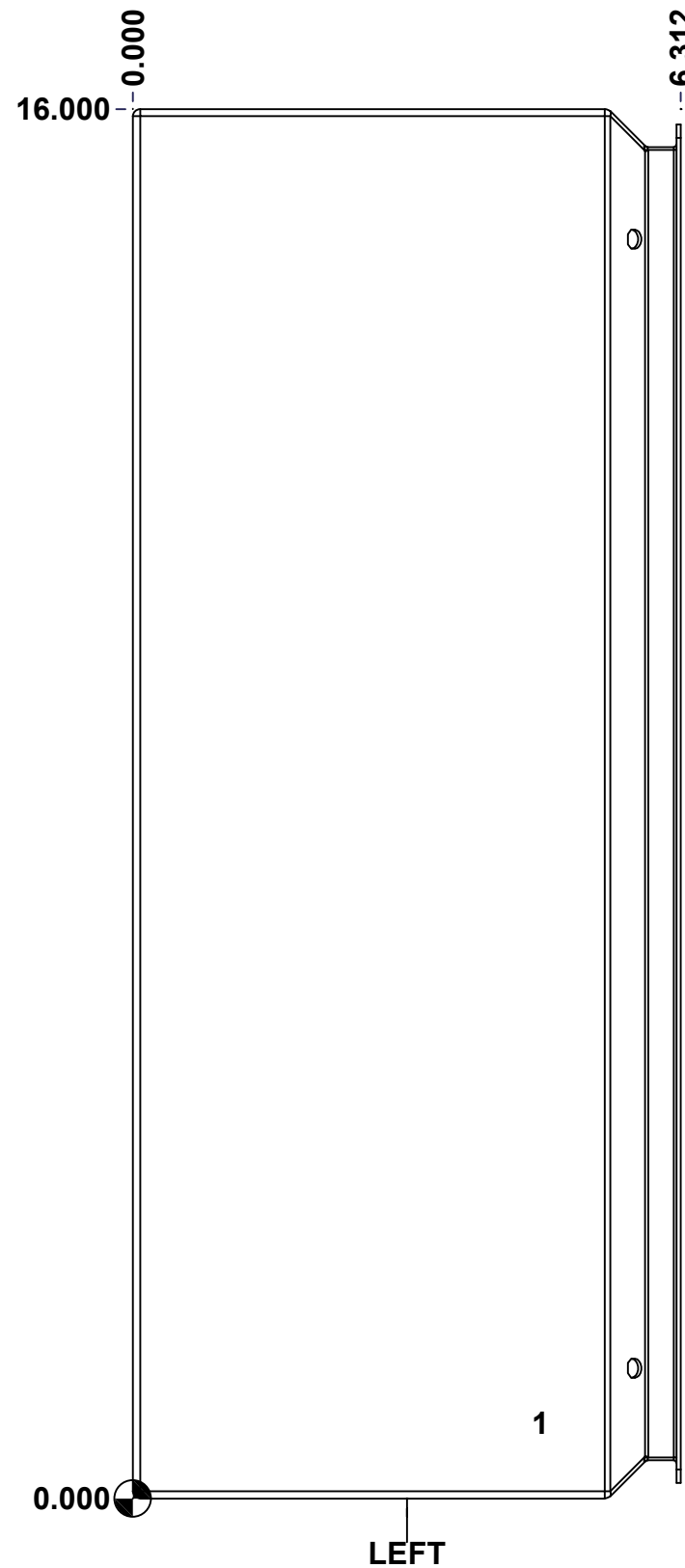

	Description	Status
	5412ESSMPCH 16" x 10" x 6" Body	(NULL)
Part Number Numéro Pièce 5412ESSMPCH1610066B	Rev.	4
	0	9

This drawing is confidential and must not be reproduced or used without the consent of EXM

Ce dessin est confidentiel et ne doit pas être reproduit ou utilisé sans le consentement de EXM

STANDARD FEATURES ARE NOT LISTED IN THIS HOLE TABLE

HOLE TABLE - BACK VIEW (CUSTOM FEATURE ONLY)

CUT-OUT	XDIM	YDIM	DESCRIPTION
1	0.875	0.875	IP STANDOFF M6 x 10mm (Inside)
2	0.875	15.125	IP STANDOFF M6 x 10mm (Inside)
3	9.125	15.125	IP STANDOFF M6 x 10mm (Inside)
4	9.125	0.875	IP STANDOFF M6 x 10mm (Inside)

5	9.000	0.000	FOOT 885 ESCHMF2
6	1.000	0.000	FOOT 885 ESCHMF2
7	9.000	16.000	FOOT 885 ESCHMF2
8	1.000	16.000	FOOT 885 ESCHMF2

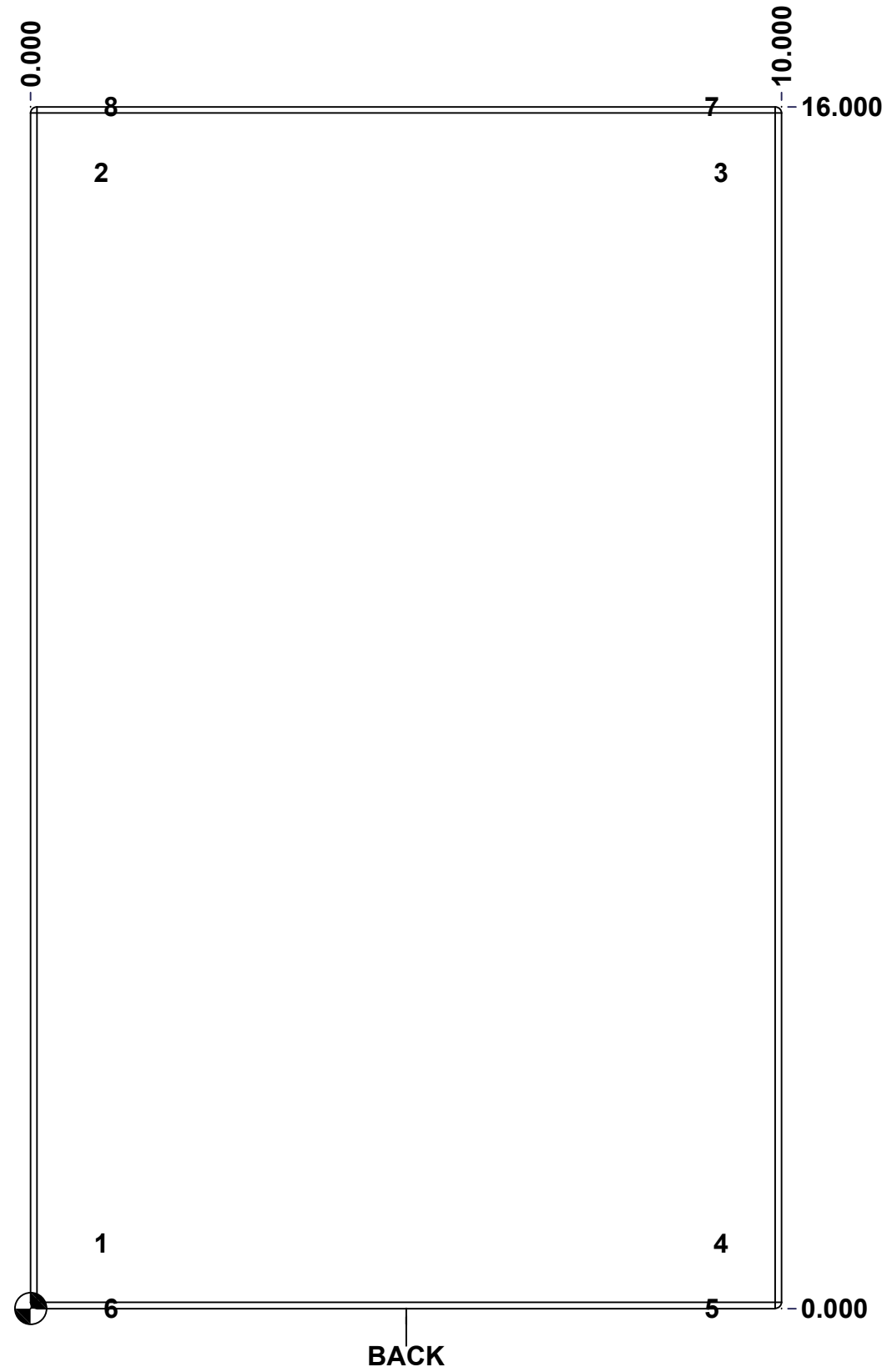

BACK

	Description	Status
	5412ESSMPCH 16" x 10" x 6" Body	(NULL)
	Part Number Numéro Pièce	Rev.
	5412ESSMPCH1610066B	0 / 5 / 9

This drawing is confidential and must not be reproduced or used without the consent of EXM

Ce dessin est confidentiel et ne doit pas être reproduit ou utilisé sans le consentement de EXM

No.	Revisions	Date	By/Par

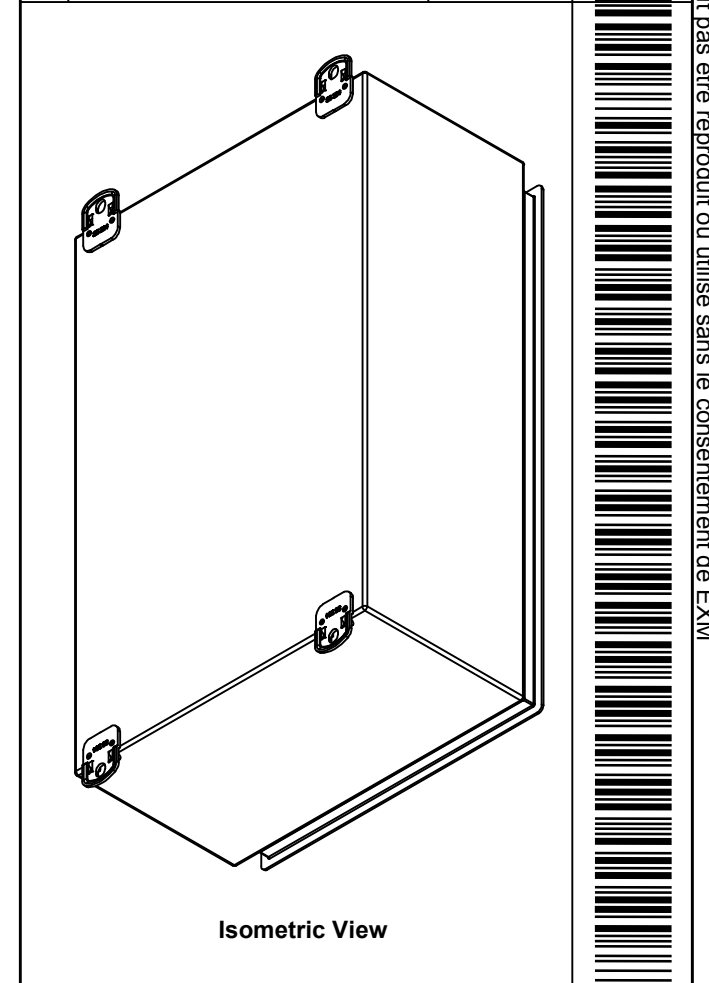

Tél: (450) 979-4373 Fax: (450) 979-4626 www.exmweb.com		Flatness Aplatissement
		Max 3.0mm
Customer Client		Date
Drawn By Dessiné Par BoxCad: BoxCad		Date 13-Mar-23
Material Matière 16 Ga Stainless Steel 316 (1.4mm)		
Color Couleur	Asa-61 Grey	Finish Fini Smooth
Description		Detail Rev.
5412ESSMPCH 16" x 10" x 6" Body		
Part Number Numéro Pièce		Rev. 6
5412ESSMPCH1610066B		0 / 9

Qty	Part Number	Rev	Description
4	STK-Q-71316	4	5412 ESSMCH Stainless Steel Mounting Foot
1	STK-P-02400S	0	Powder Paint (Asa-61 Grey / Smooth)
1	5412ESSMPCH1610066B-P	0	5412ESSMPCH 16" x 10" x 6" Body Part
2	STK-A-70469	6	5412 ESSMCH - Stainless Steel 316 Body Catch Assembly
2	STK-Q-08100	1	M5 Nylon Insert Lock Nut
5	STK-Q-08500	4	Stainless Steel Standoff M6 x 10mm
Parts List			

This drawing is confidential and must not be reproduced or used without the consent of EXM

Ce dessin est confidentiel et ne doit pas être reproduit ou utilisé sans le consentement de EXM

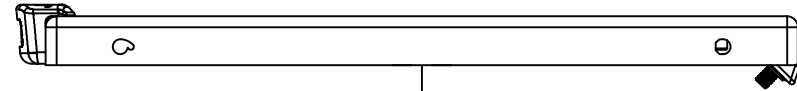

TOP

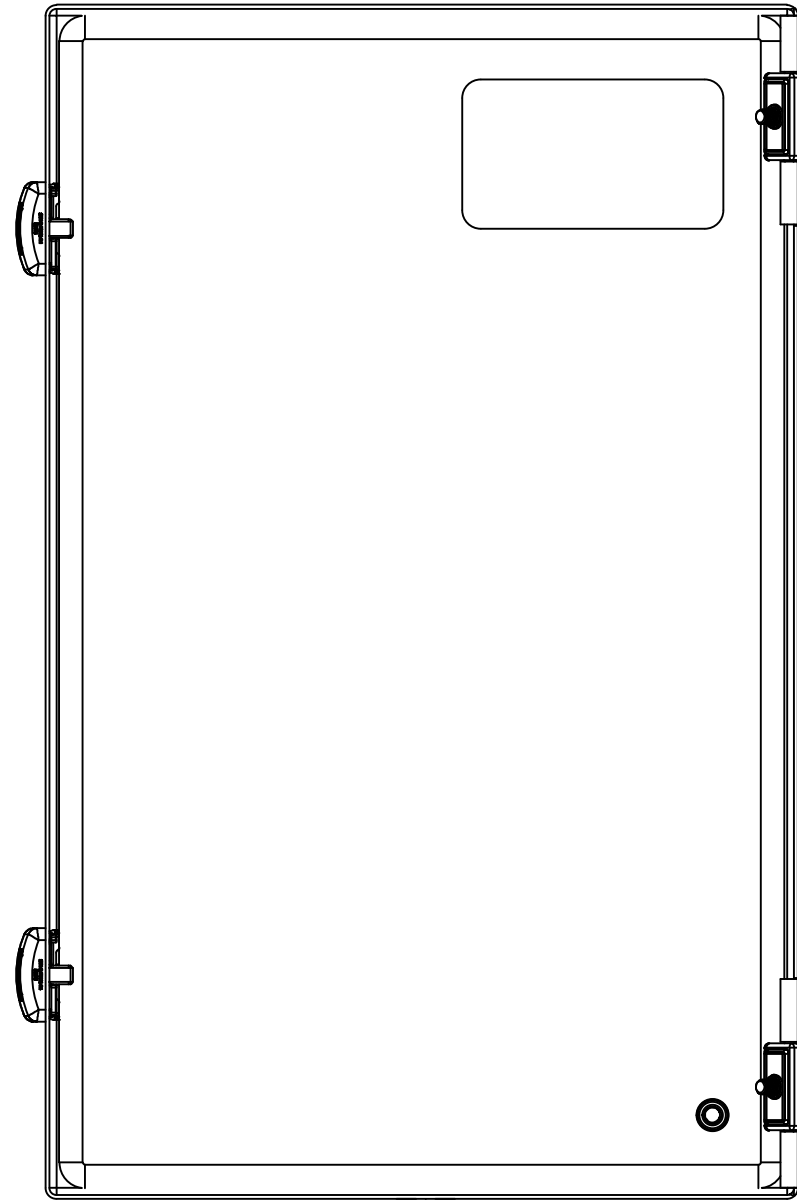

BACK

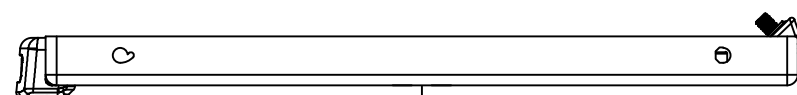

BOTTOM

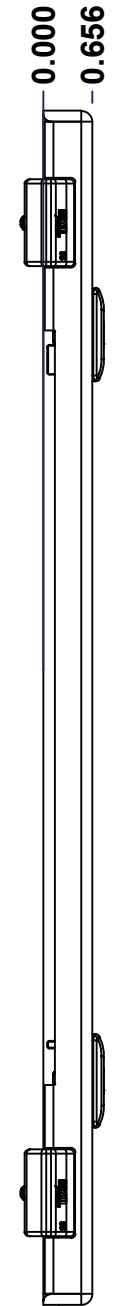

LEFT

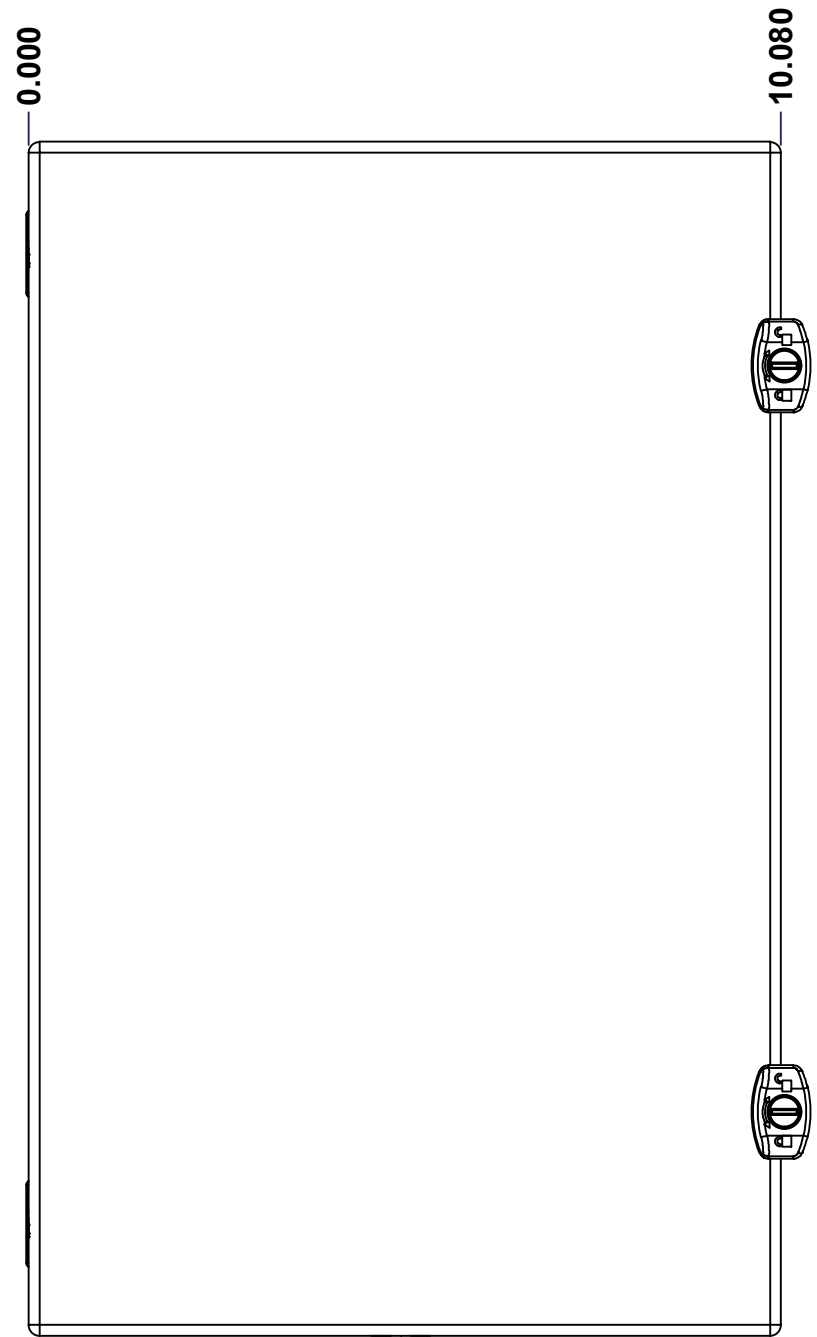

FRONT

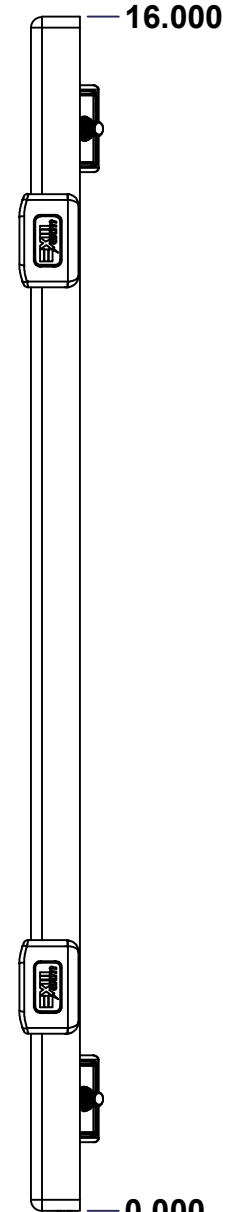

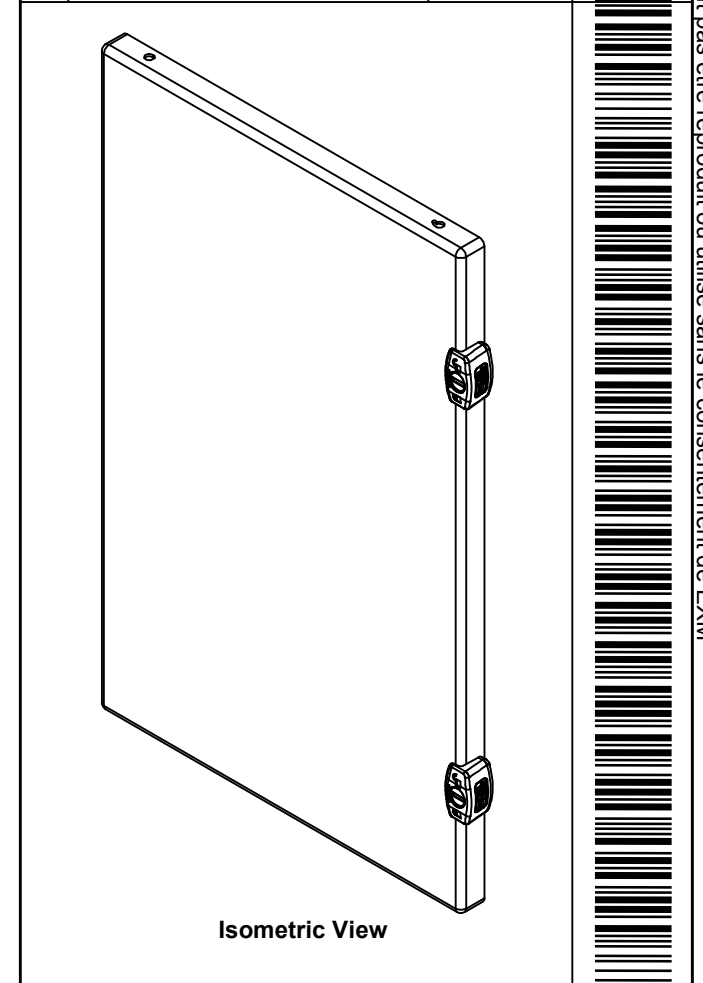

RIGHT

No.	Revisions	Date	By/Par

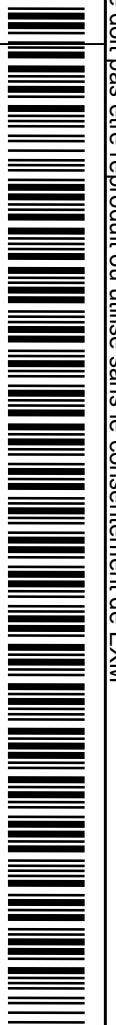

Isometric View

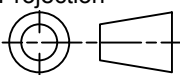

 Tél: (450) 979-4373 Fax: (450) 979-4626 www.exmweb.com		Flatness Aplatissement Max 3.0mm Projection 
Customer Client	Date	
Drawn By Dessiné Par	BoxCad: BoxCad	Date 13-Mar-23
Material Matière	16 Ga Stainless Steel 316 (1.4mm)	
Color Couleur	Asa-61 Grey	Finish Fini Smooth
Description	Detail Rev.	
5412ESSMPCH 16" x 10" Cover		
Part Number Numéro Pièce	Rev.	7
5412ESSMPCH1610066C	0	9

SEE BILL OF MATERIAL ON LAST PAGE

This drawing is confidential and must not be reproduced or used without the consent of EXM

Ce dessin est confidentiel et ne doit pas être reproduit ou utilisé sans le consentement de EXM

STANDARD FEATURES ARE NOT LISTED IN THIS HOLE TABLE

HOLE TABLE - FRONT VIEW (CUSTOM FEATURE ONLY)

CUT-OUT	XDIM	YDIM	DESCRIPTION
1	1.145	1.125	STANDOFF M6 x 10mm (Inside)
2	2.750	14.000	LABEL_EXM
3	10.080	13.000	LOCK 880 SCQ3MS @ 0.0°
4	10.080	3.000	LOCK 880 SCQ3MS @ 0.0°

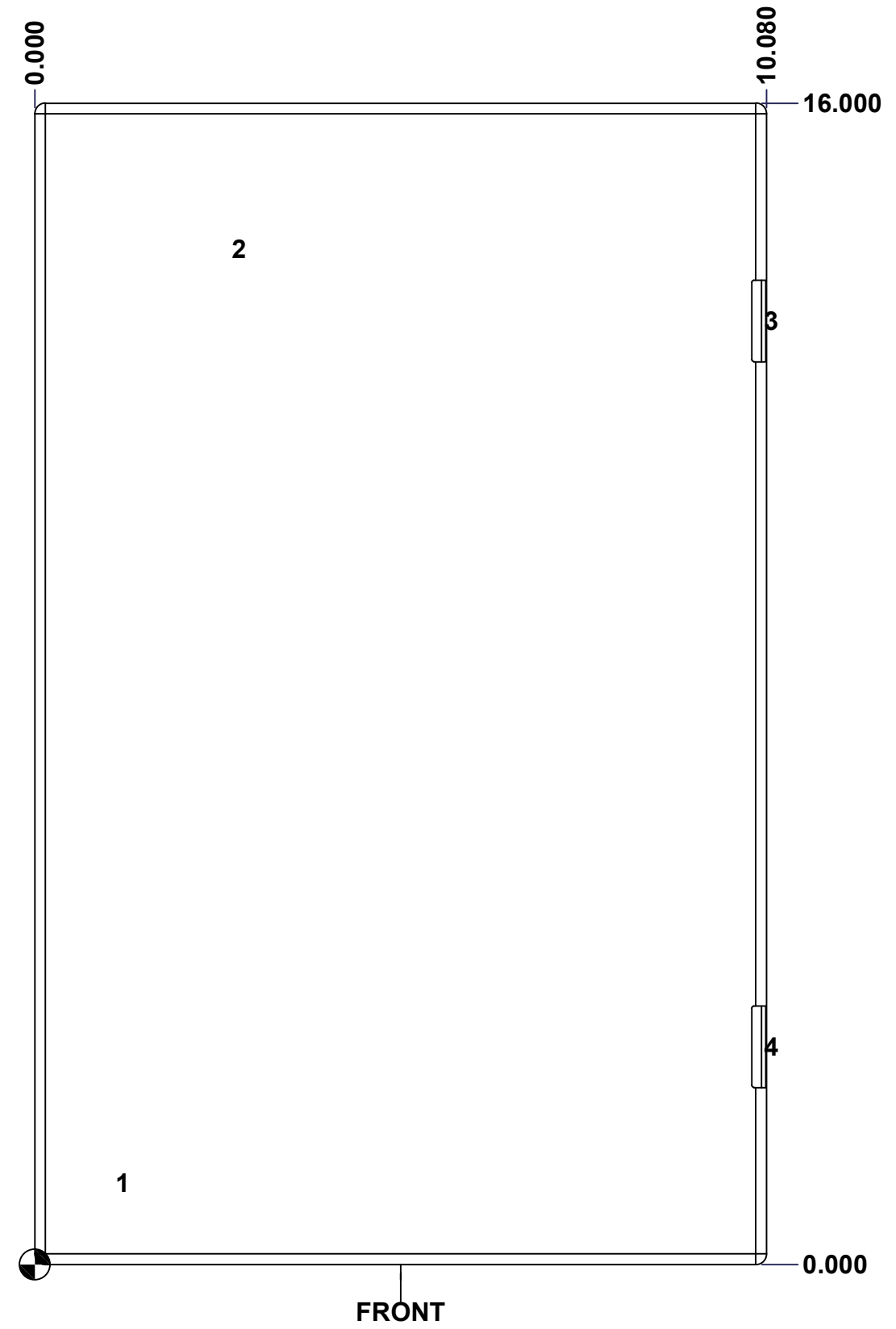

	Description	Status
	5412ESSMPCH 16" x 10" Cover	(NULL)
	Part Number Numéro Pièce	Rev.
	5412ESSMPCH1610066C	0 / 8 / 9

This drawing is confidential and must not be reproduced or used without the consent of EXM

Ce dessin est confidentiel et ne doit pas être reproduit ou utilisé sans le consentement de EXM

No.	Revisions	Date	By/Par

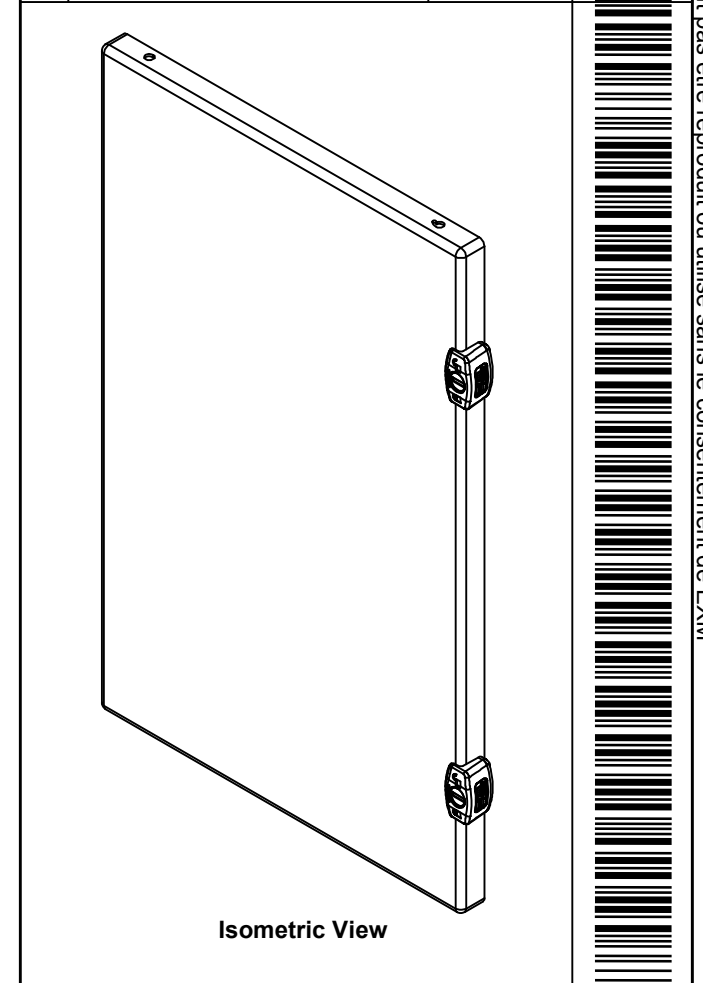

Qty	Part Number	Rev	Description
1	5412ESSMPCH1610066G	0	5412ESSMPCH 16" x 10" Gasket
1	STK-S-00100	0	3.5" x 2" Silver Milar Flexcon Sticker
1	STK-Q-08500	4	Stainless Steel Standoff M6 x 10mm
1	STK-P-02400S	0	Powder Paint (Asa-61 Grey / Smooth)
1	5412ESSMPCH1610066C-P	0	5412ESSMPCH 16" x 10" Cover Part
2	STK-A-33038	3	5412 ESSMCH - Stainless Steel Hinge
2	880SCQ3S	4	5412 ESSMCH - Stainless Steel External Lock Assy - Slot Lock
Parts List			

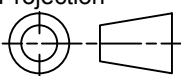
 Tél: (450) 979-4373 Fax: (450) 979-4626 www.exmweb.com		Flatness Aplatissement Max 3.0mm Projection 
Customer Client	Date	
Drawn By / Dessiné Par: BoxCad: BoxCad	Date: 13-Mar-23	
Material / Matière: 16 Ga Stainless Steel 316 (1.4mm)	Color / Couleur: Asa-61 Grey	
Finish / Fini: Smooth		Detail Rev.
Description: 5412ESSMPCH 16" x 10" Cover		Rev. 9
Part Number / Numéro Pièce: 5412ESSMPCH1610066C		0

This drawing is confidential and must not be reproduced or used without the consent of EXM

Ce dessin est confidentiel et ne doit pas être reproduit ou utilisé sans le consentement de EXM

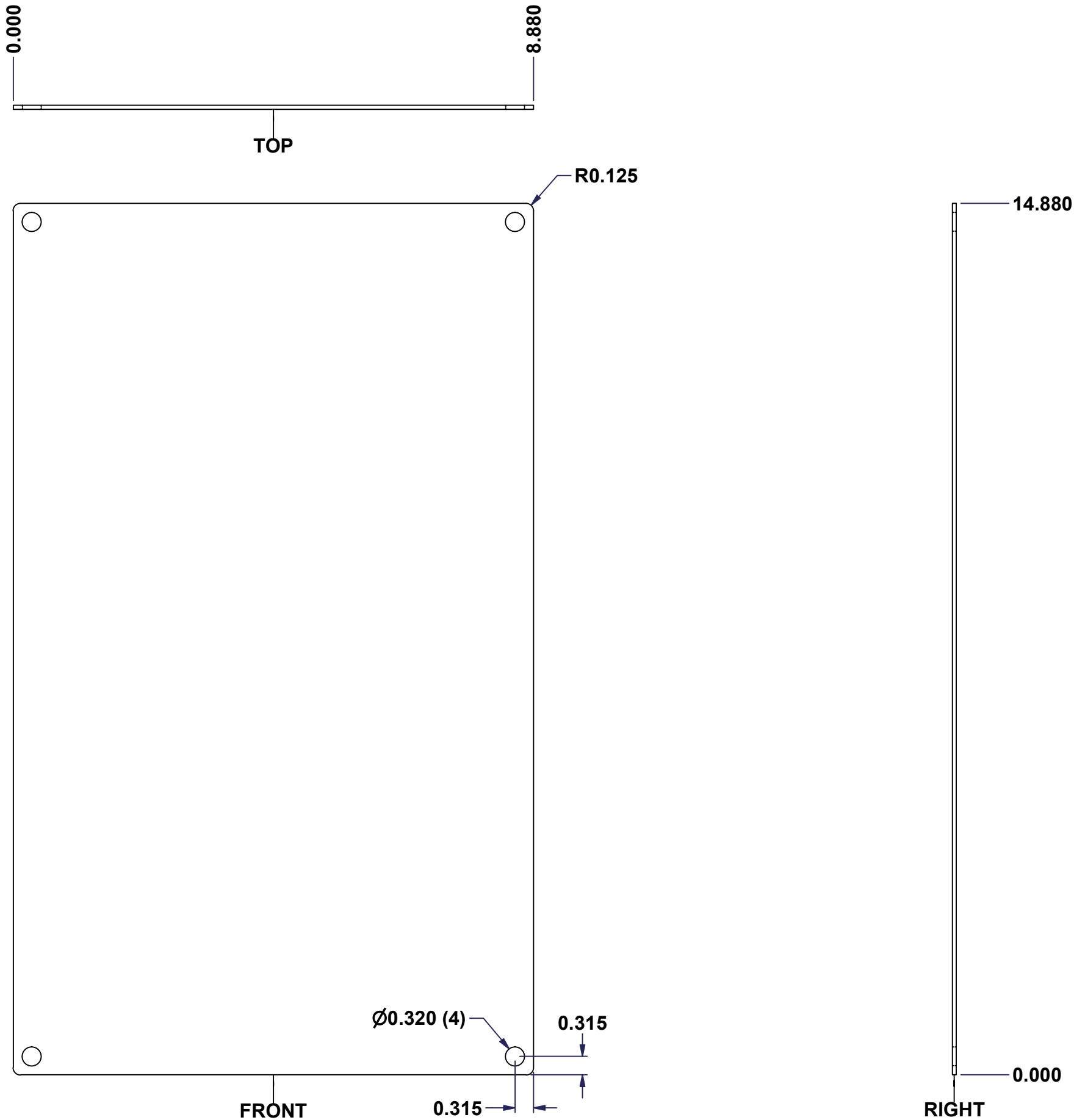

No.	Revisions	Date	By/Par

Isometric View

<p>Tél: (450) 979-4373 Fax: (450) 979-4626 www.exmweb.com</p>		Flatness Aplatissement	
		Max 3.0mm	
Customer Client		Date	
Drawn By Dessiné Par BoxCad		Date 23-Jan-07	
Material Matière 14 Ga Galvanized (1.7mm)		Projection	
Color Couleur Unpainted		Finish Fini Galvanized	
Description 880 SP1610G - Inner Panel		Detail Rev.	
Part Number Numéro Pièce 880 SP1610G		Rev. 0	1 2

SEE BILL OF MATERIAL ON LAST PAGE

This drawing is confidential and must not be reproduced or used without the consent of EXM

Ce dessin est confidentiel et ne doit pas être reproduit ou utilisé sans le consentement de EXM

No.	Revisions	Date	By/Par

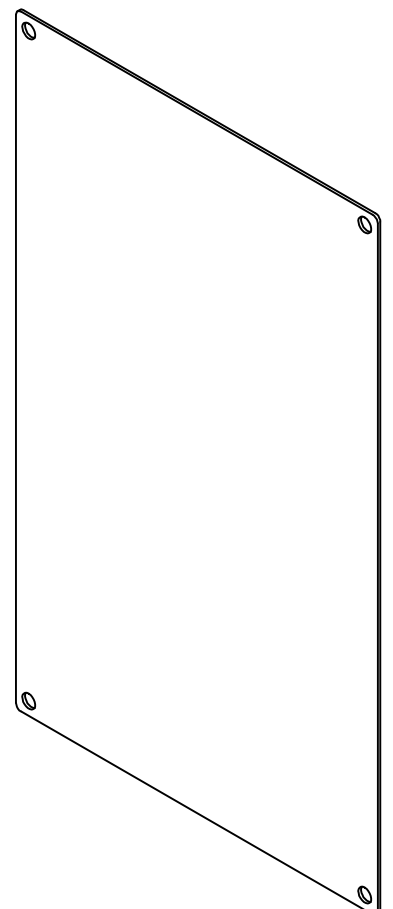

Isometric View

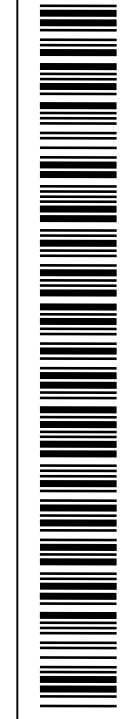

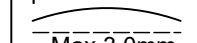
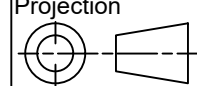
		Tél: (450) 979-4373 Fax: (450) 979-4626 www.exmweb.com		Flatness Aplatissement  Max 3.0mm	
Projection 		Customer Client		Date	
Drawn By Dessiné Par		BoxCad		Date 23-Jan-07	
Material Matière		14 Ga Galvanized (1.7mm)			
Color Couleur		Unpainted		Finish Fini Galvanized	
Description				Detail Rev.	
880 SP1610G - Inner Panel					
Part Number Numéro Pièce		880 SP1610G		Rev.	2
				0	2

Qty	Part Number	Rev	Description
1	880 SP1610G-P	0	880 SP1610G - Inner Panel Part
Parts List			