

This drawing is confidential and must not be reproduced or used without the consent of EXM

Ce dessin est confidentiel et ne doit pas être reproduit ou utilisé sans le consentement de EXM

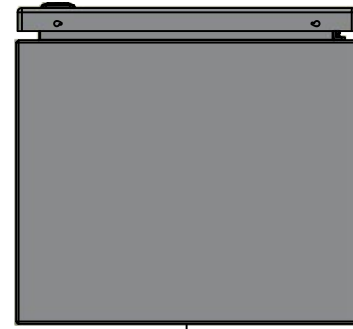

TOP



BACK

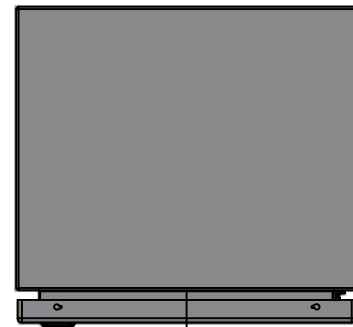

BOTTOM

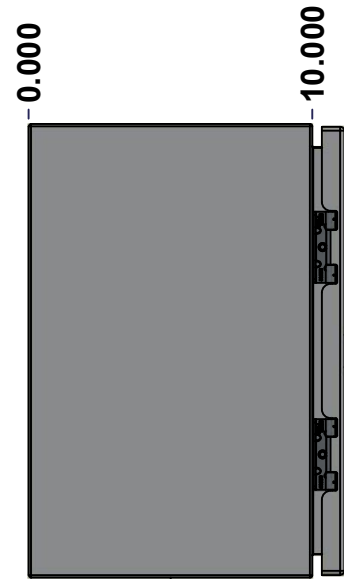

LEFT

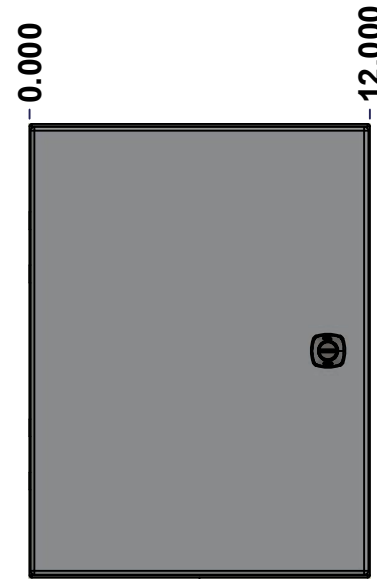

FRONT

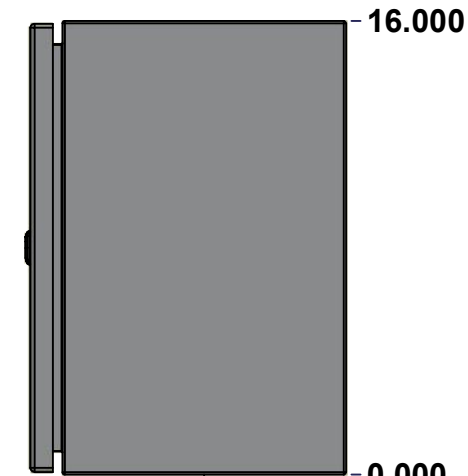

RIGHT

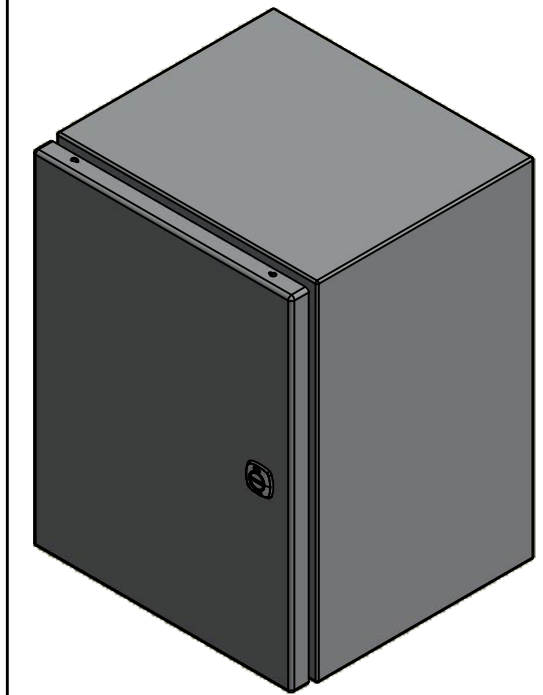

Isometric View

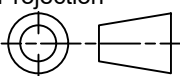

No.	Revisions	Date	By/Par

 Tél: (450) 979-4373 Fax: (450) 979-4626 <a href="http://www.exmweb.com">www.exmweb.com</a>		Flatness Aplatissement Max 3.0mm Projection 
Customer Client	Date	
Drawn By Dessiné Par	BoxCad: BoxCad	Date 6/23/2022
Material Matière	16 Ga Stainless Steel 316 (1.4mm)	
Color Couleur	Asa-61 Grey	Finish Fini Smooth
Description	Detail Rev.	
5412ESSP 16" x 12" x 10" Assembly		
Part Number Numéro Pièce	Rev.	1
5412ESSP1612106	0	9

SEE BILL OF MATERIAL ON LAST PAGE

This drawing is confidential and must not be reproduced or used without the consent of EXM

Ce dessin est confidentiel et ne doit pas être reproduit ou utilisé sans le consentement de EXM

NOTE	
ITEM	DESCRIPTION
1	NEMA 4X Enclosure
2	C/W Standard ground studs on box and cover
3	C/W Standard door stiffener
4	C/W Standard inner panel (Included)
5	C/W Standard inner panel mounting studs

No.	Revisions	Date	By/Par

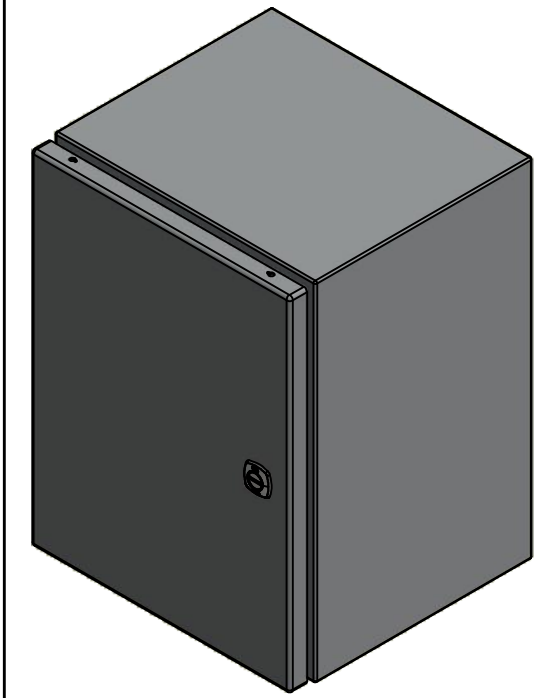

Isometric View



 Tél: (450) 979-4373  
 Fax: (450) 979-4626  
[www.exmweb.com](http://www.exmweb.com)

Flatness  
 Aplatissement  
 Max 3.0mm  
 Projection  

Customer Client	Date
Drawn By / Dessiné Par: BoxCad: BoxCad	Date: 6/23/2022

Material / Matière: 16 Ga Stainless Steel 316 (1.4mm)

Color / Couleur: Asa-61 Grey	Finish / Fini: Smooth
------------------------------	-----------------------

Description: 5412ESSP 16" x 12" x 10" Assembly

Part Number / Numéro Pièce: <b>5412ESSP1612106</b>	Rev. 0	2
--	--------	---

Qty	Part Number	Rev	Description
1	STK-K-01800	5	5412 ES Accessory Kit
1	881 SP1612G	0	881 SP - Inner Panel
1	5412ESSP1612106C	0	5412ESSP 16" x 12" Cover
4	STK-Q-07310	2	Flange Lock Nut M8
4	STK-Q-07610	8	M8 Plastic Spacer 22.2mm
1	5412ESSP1612106B	0	5412ESSP 16" x 12" x 10" Body
2	STK-Q-04051-07	8	M6 x 7mm Stainless Steel Hexagon Socket Head Machine Screw with Nyseal
Parts List			

PACKING		
ITEM	QTY	DESCRIPTION
Cardboard sleeve	2	Top and Bottom
Cardboard strip	2	Between back of enclosure and inner panel
Plastic bag	1	To protect cover surface and inside gasket
Plastic strap - Black	2	To Squeeze the 2 cardboard sleeve together
Packaging label	1	White label with product number

This drawing is confidential and must not be reproduced or used without the consent of EXM

Ce dessin est confidentiel et ne doit pas être reproduit ou utilisé sans le consentement de EXM

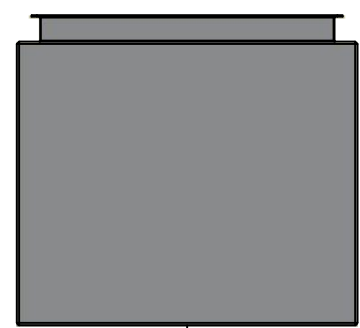

TOP

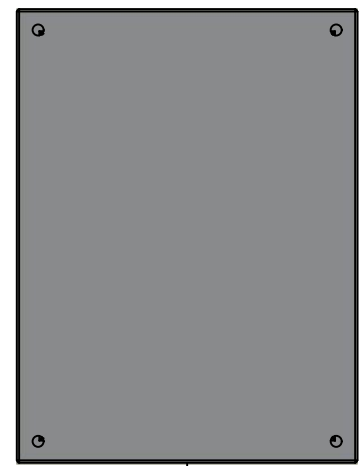

BACK

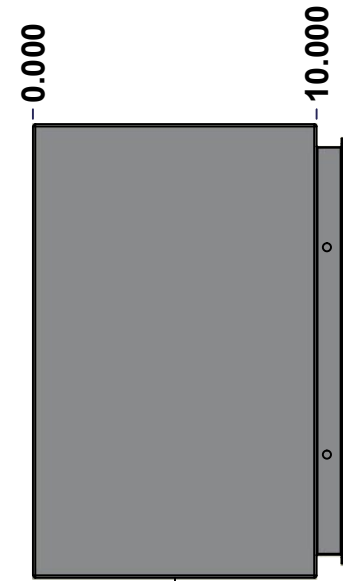

LEFT

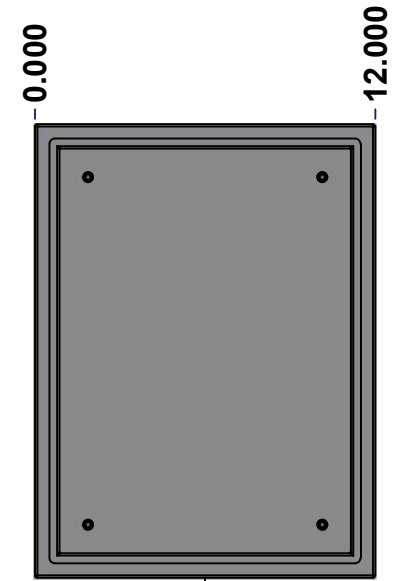

FRONT

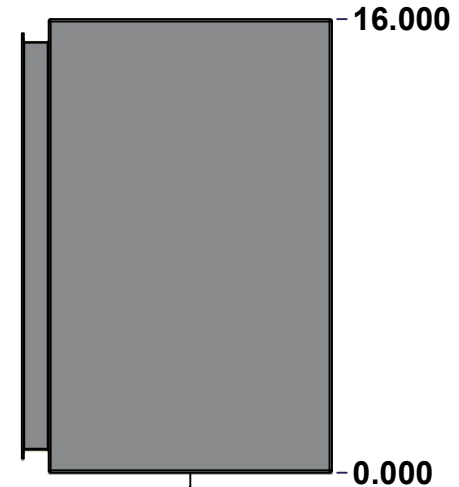

RIGHT

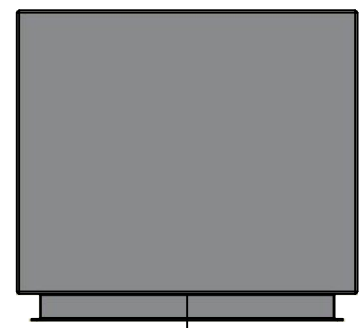

BOTTOM

No.	Revisions	Date	By/Par

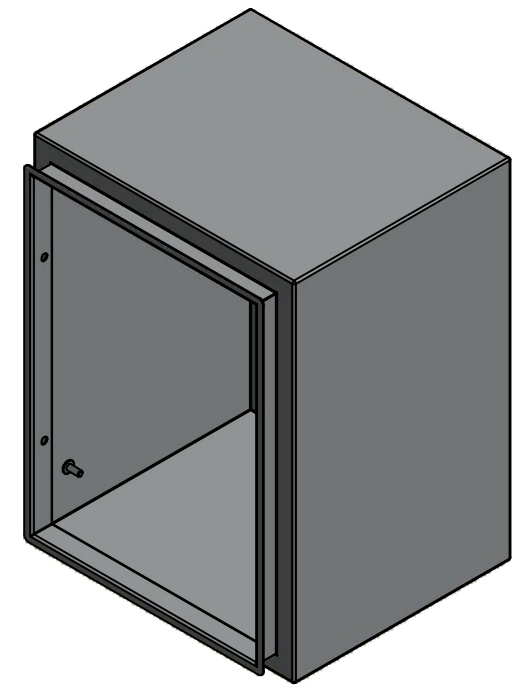

Isometric View

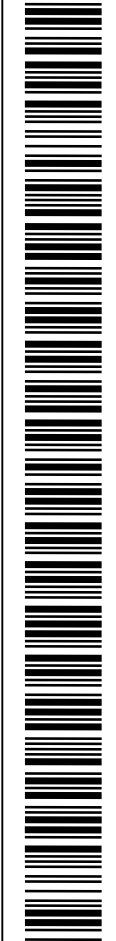

Tél: (450) 979-4373  
 Fax: (450) 979-4626  
[www.exmweb.com](http://www.exmweb.com)

Flatness  
 Aplatissement  
 Max 3.0mm  
 Projection

Customer Client	Date
Drawn By / Dessiné Par: BoxCad: BoxCad	Date: 6/23/2022
Material / Matière: 16 Ga Stainless Steel 316 (1.4mm)	
Color / Couleur: Asa-61 Grey	Finish / Fini: Smooth
Description: 5412ESSP 16" x 12" x 10" Body	Detail Rev.

Part Number / Numéro Pièce: <b>5412ESSP1612106B</b>	Rev. 0	3 / 9
---	--------	-------

SEE BILL OF MATERIAL ON LAST PAGE

This drawing is confidential and must not be reproduced or used without the consent of EXM

Ce dessin est confidentiel et ne doit pas être reproduit ou utilisé sans le consentement de EXM

**STANDARD FEATURES ARE NOT LISTED IN THIS HOLE TABLE**

**HOLE TABLE - LEFT VIEW (CUSTOM FEATURE ONLY)**

CUT-OUT	XDIM	YDIM	DESCRIPTION
1	8.500	2.000	GND STUD M6 x 16mm (Inside)

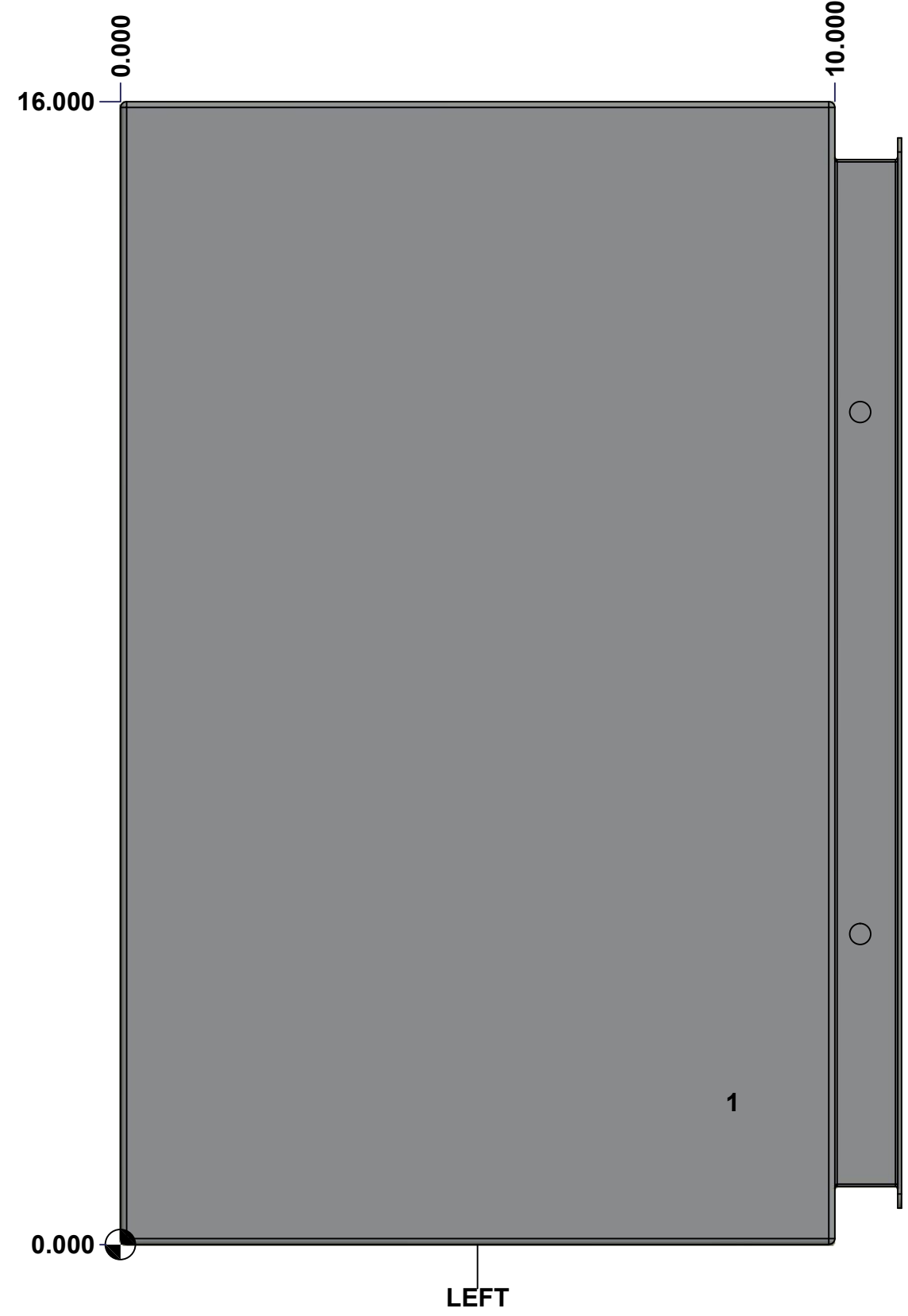

	Description	Status
	5412ESSP 16" x 12" x 10" Body	(NULL)
Part Number Numéro Pièce <b>5412ESSP1612106B</b>	Rev.	4
	<b>0</b>	9

This drawing is confidential and must not be reproduced or used without the consent of EXM

Ce dessin est confidentiel et ne doit pas être reproduit ou utilisé sans le consentement de EXM

**STANDARD FEATURES ARE NOT LISTED IN THIS HOLE TABLE**

**HOLE TABLE - BACK VIEW (CUSTOM FEATURE ONLY)**

CUT-OUT	XDIM	YDIM	DESCRIPTION
1	1.875	1.875	IP STUD M8 x 35mm (Inside)
2	1.875	14.125	IP STUD M8 x 35mm (Inside)
3	10.125	14.125	IP STUD M8 x 35mm (Inside)
4	10.125	1.875	IP STUD M8 x 35mm (Inside)
-----			
5	11.250	0.750	RND Ø0.390
6	11.250	15.250	RND Ø0.390
7	0.750	15.250	RND Ø0.390
8	0.750	0.750	RND Ø0.390

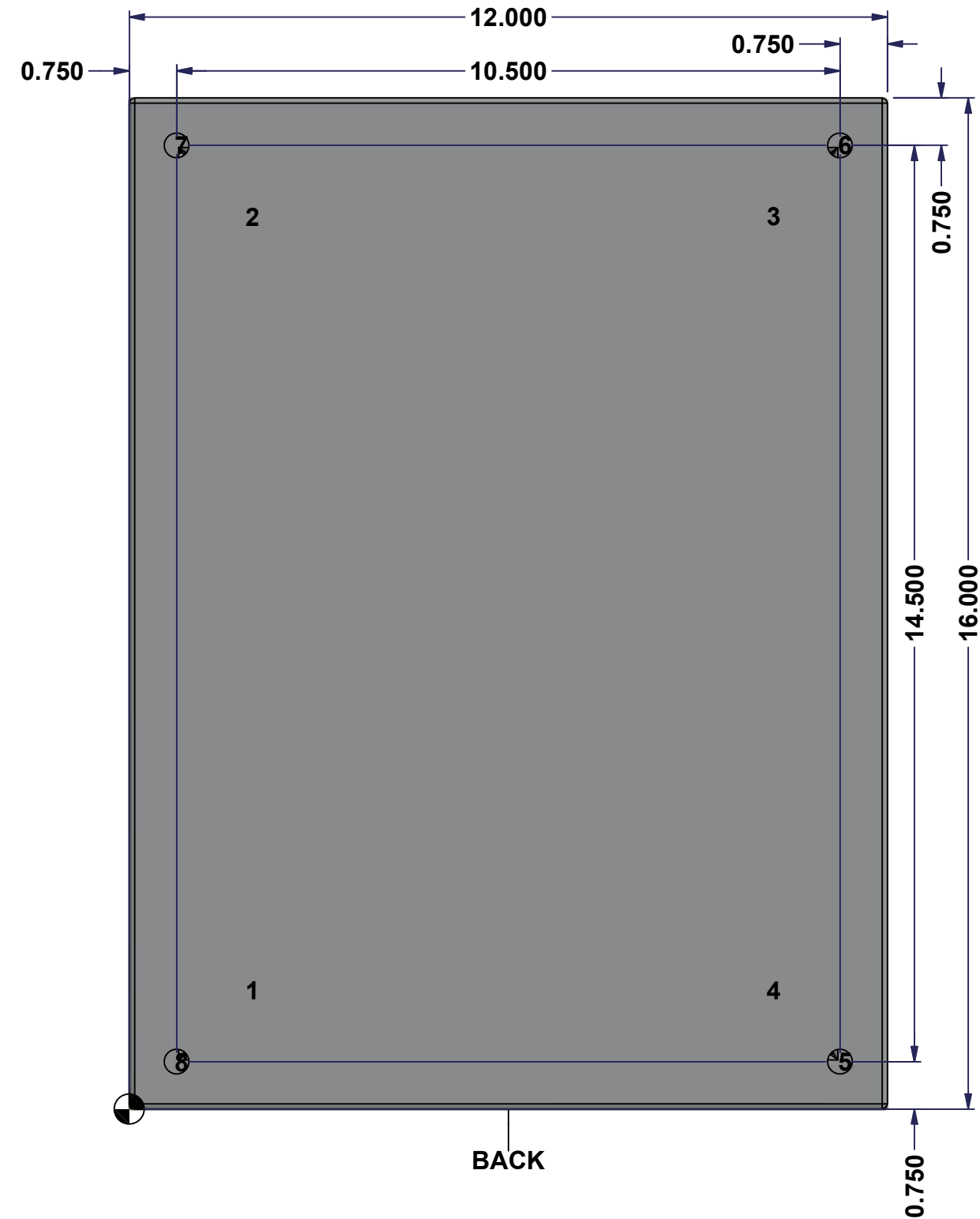

	Description	Status	
	5412ESSP 16" x 12" x 10" Body	(NULL)	
	Part Number	Rev.	5
	Numéro Pièce	<b>0</b>	9
	<b>5412ESSP1612106B</b>		

This drawing is confidential and must not be reproduced or used without the consent of EXM

Ce dessin est confidentiel et ne doit pas être reproduit ou utilisé sans le consentement de EXM

No.	Revisions	Date	By/Par

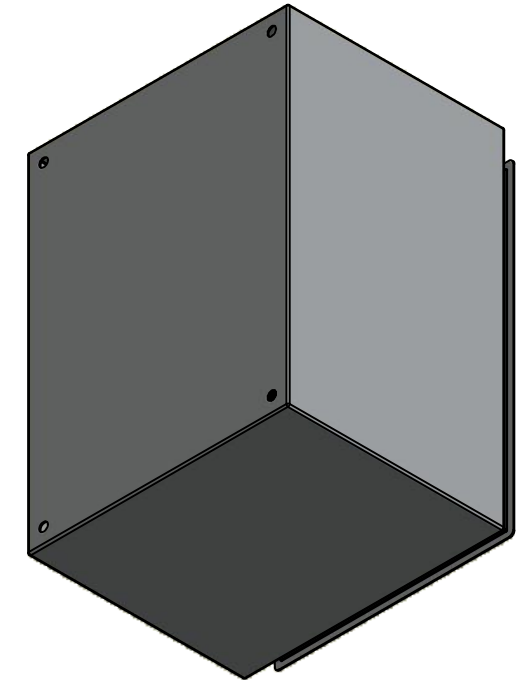

Isometric View



 Tél: (450) 979-4373 Fax: (450) 979-4626 <a href="http://www.exmweb.com">www.exmweb.com</a>		Flatness Aplatissement Max 3.0mm
Customer Client		Date
Drawn By / Dessiné Par: BoxCad: BoxCad		Date: 6/23/2022
Material / Matière: 16 Ga Stainless Steel 316 (1.4mm)		
Color / Couleur: Asa-61 Grey	Finish / Fini: Smooth	
Description: 5412ESSP 16" x 12" x 10" Body		Detail Rev.
Part Number / Numéro Pièce: <b>5412ESSP1612106B</b>		Rev. 6 0 / 9

Qty	Part Number	Rev	Description
1	STK-Q-16085	0	Ground Stud M6 x 16mm Stainless Steel
1	STK-P-02400S	0	Powder Paint (Asa-61 Grey / Smooth)
4	STK-Q-16020	1	Stud M8 x 35mm Stainless Steel
1	5412ESSP1612106B-P	0	5412ESSP 16" x 12" x 10" Body Part
Parts List			

This drawing is confidential and must not be reproduced or used without the consent of EXM

Ce dessin est confidentiel et ne doit pas être reproduit ou utilisé sans le consentement de EXM

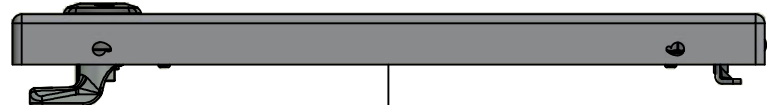

TOP

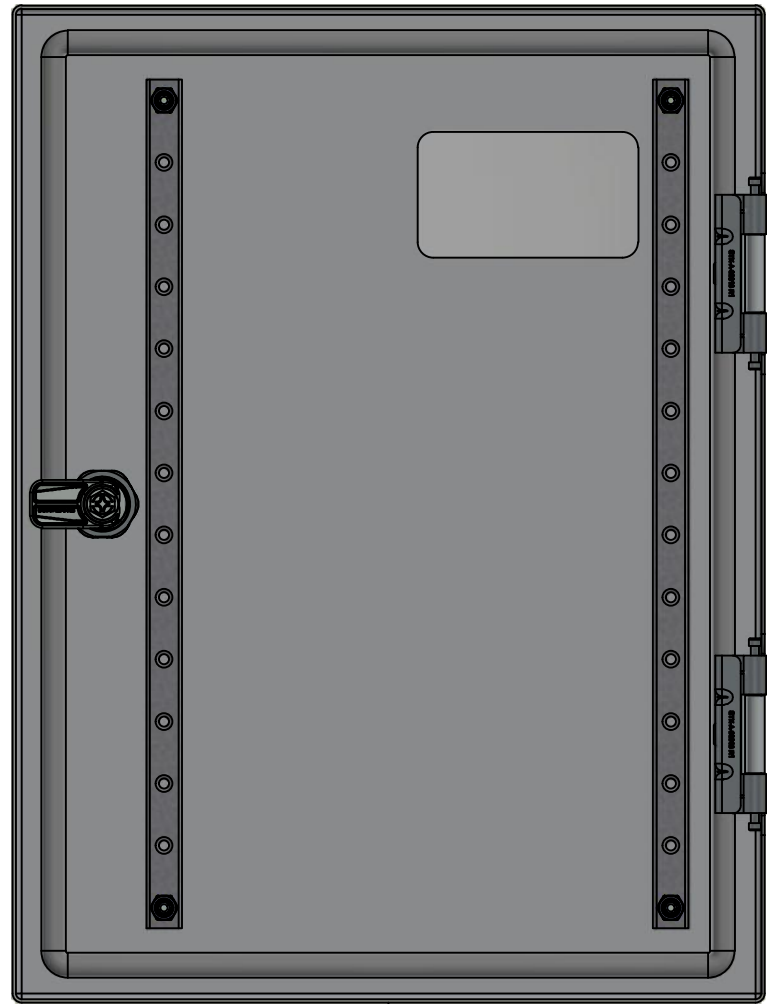

BACK



BOTTOM

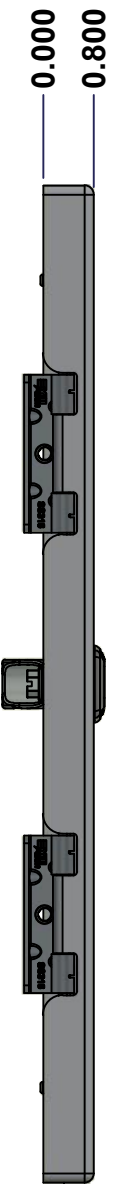

LEFT



FRONT

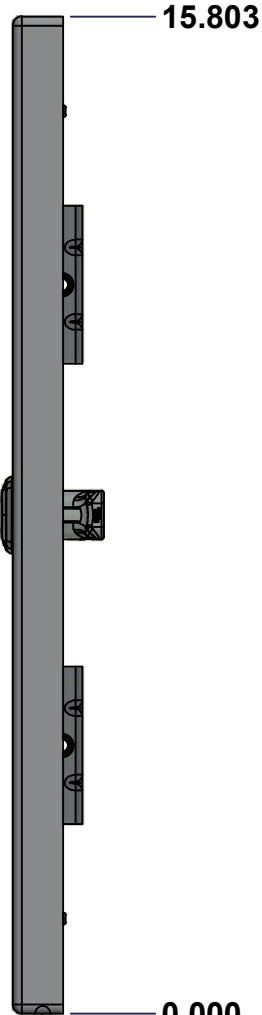

RIGHT

No.	Revisions	Date	By/Par

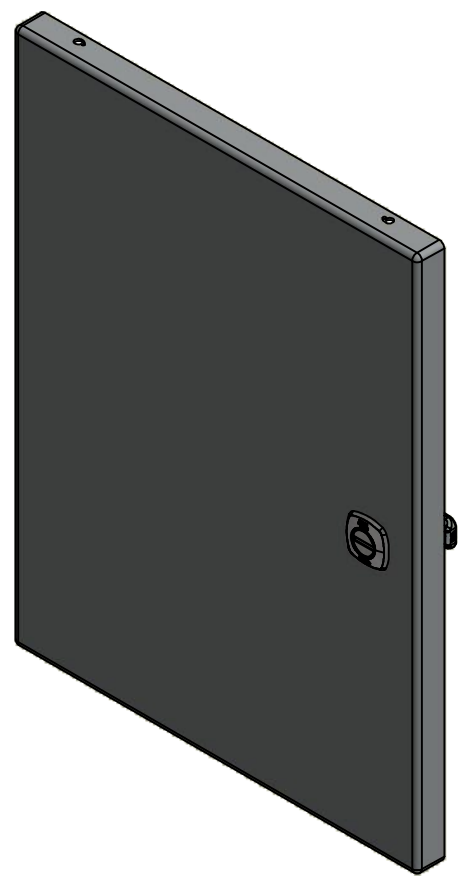

Isometric View

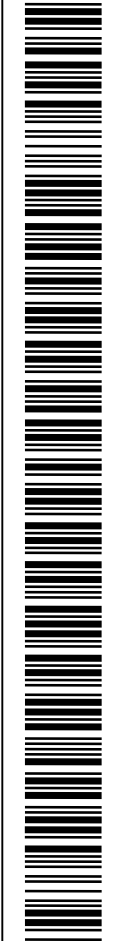

Tél: (450) 979-4373 Fax: (450) 979-4626 <a href="http://www.exmweb.com">www.exmweb.com</a>	Flatness Aplatissement	Max 3.0mm
	Projection	
Customer Client	Date	
Drawn By Dessiné Par	BoxCad: BoxCad	Date 6/23/2022
Material Matière	16 Ga Stainless Steel 316 (1.4mm)	
Color Couleur	Asa-61 Grey	Finish Fini Smooth
Description	5412ESSP 16" x 12" Cover	
Part Number Numéro Pièce	Rev. 0	7 9

SEE BILL OF MATERIAL ON LAST PAGE

**5412ESSP1612106C**

This drawing is confidential and must not be reproduced or used without the consent of EXM

Ce dessin est confidentiel et ne doit pas être reproduit ou utilisé sans le consentement de EXM

**STANDARD FEATURES ARE NOT LISTED IN THIS HOLE TABLE**

**HOLE TABLE - FRONT VIEW (CUSTOM FEATURE ONLY)**

CUT-OUT	XDIM	YDIM	DESCRIPTION
1	1.486	1.504	STUD M6 x 18mm (Inside)
2	1.486	14.299	STUD M6 x 18mm (Inside)
3	9.517	14.299	STUD M6 x 18mm (Inside)
4	9.517	1.504	STUD M6 x 18mm (Inside)
-----			
5	3.750	12.803	LABEL_EXM (Inside)
6	10.494	7.902	LOCK 880 SCQ4-SLSS6 @ 0.0°

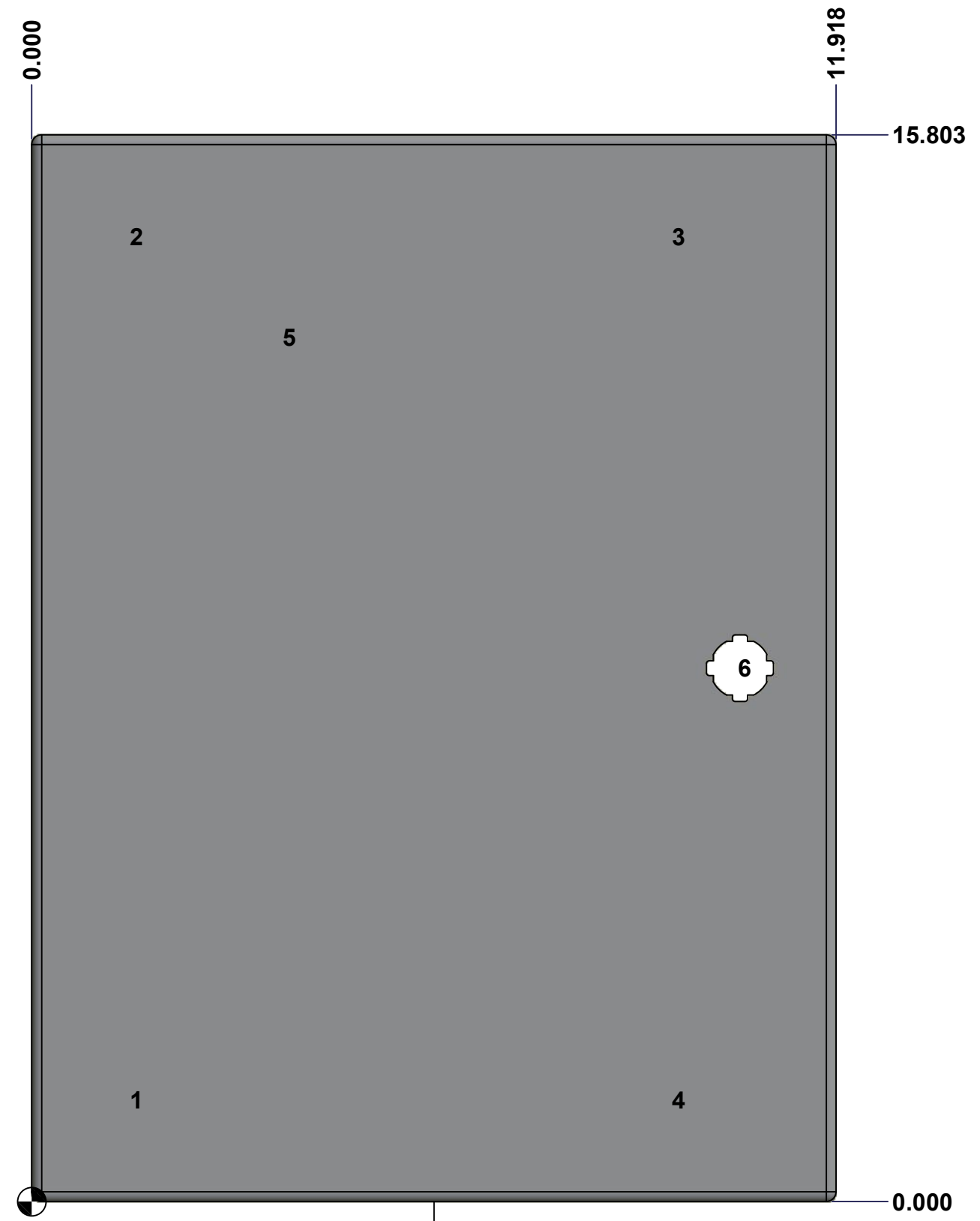

FRONT

	Description	Status	
	5412ESSP 16" x 12" Cover	(NULL)	
	Part Number Numéro Pièce	Rev.	
	<b>5412ESSP1612106C</b>	<b>0</b>	8 9



This drawing is confidential and must not be reproduced or used without the consent of EXM

Ce dessin est confidentiel et ne doit pas être reproduit ou utilisé sans le consentement de EXM

No.	Revisions	Date	By/Par

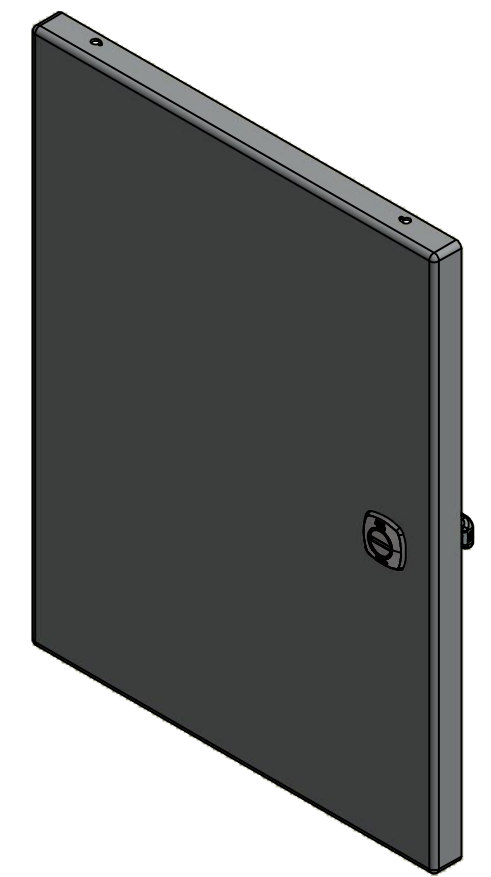

Isometric View



 Tél: (450) 979-4373  
 Fax: (450) 979-4626  
[www.exmweb.com](http://www.exmweb.com)

Flatness / Aplatissement: Max 3.0mm  
 Projection: 

Customer / Client	Date
Drawn By / Dessiné Par: BoxCad: BoxCad	Date: 6/23/2022
Material / Matière: 16 Ga Stainless Steel 316 (1.4mm)	
Color / Couleur: Asa-61 Grey	Finish / Fini: Smooth

Qty	Part Name	Rev	Description
1	880 SCQ4-SLSS6	7	5412 ESS 1/4 Turn Lock
1	STK-S-00100	0	3.5" x 2" Silver Milar Flexcon Sticker
1	STK-P-02400S	0	Powder Paint (Asa-61 Grey / Smooth)
2	STK-Q-46020-16	5	5412 ES Vertical Door Stiffener 16"
4	STK-Q-16070	1	Stud M6 x 18mm Stainless steel
1	5412ESSP1612106G	0	5412ESSP 16" x 12" Cover Gasket Part
1	5412ESSP1612106C-P	0	5412ESSP 16" x 12" Cover Part
2	STK-A-33016	0	5412 ESS Bended Hinge (Body Part)
4	STK-Q-07220	1	M6 Nylon Insert Lock Nut

Description: 5412ESSP 16" x 12" Cover	Detail Rev.
Part Number / Numéro Pièce: <b>5412ESSP1612106C</b>	Rev. 0

Parts List

9 / 9

This drawing is confidential and must not be reproduced or used without the consent of EXM

Ce dessin est confidentiel et ne doit pas être reproduit ou utilisé sans le consentement de EXM

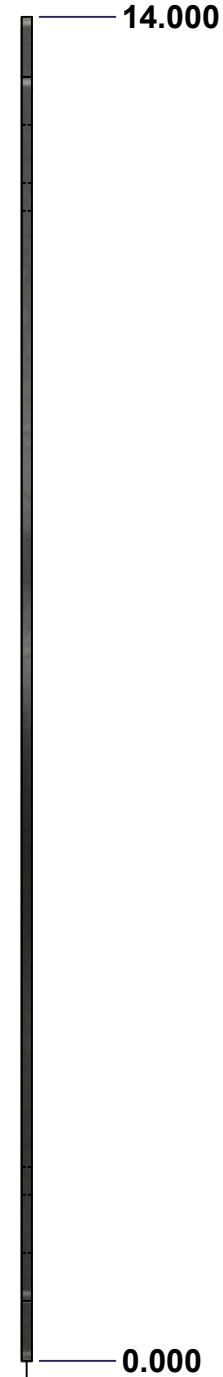
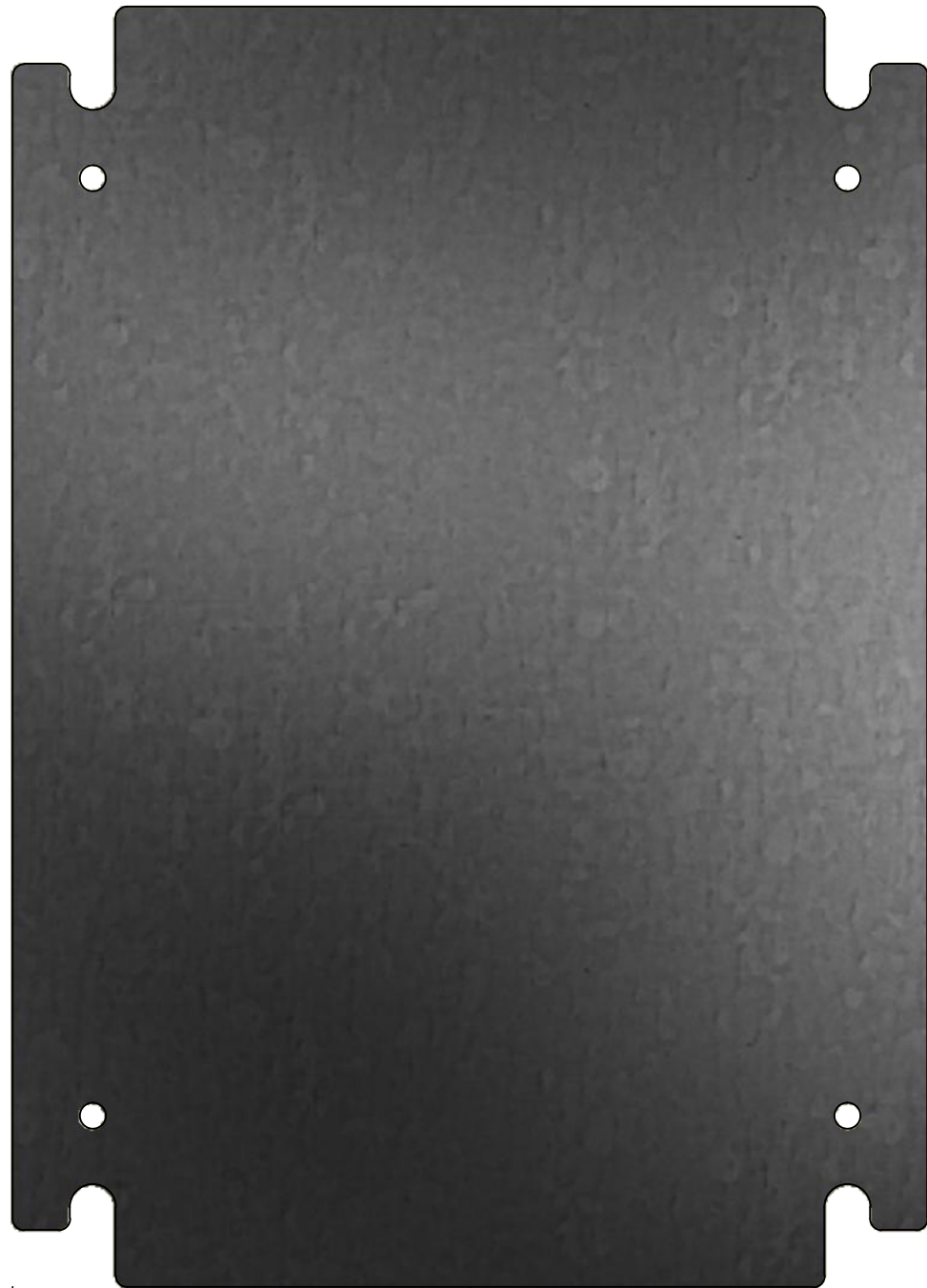
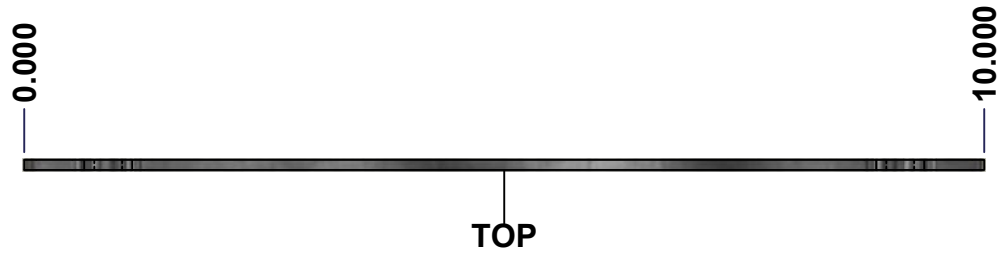

No.	Revisions	Date	By/Par



Isometric View



Tél: (450) 979-4373  
 Fax: (450) 979-4626  
 www.exmweb.com

Flatness  
 Aplatissement  
 Max 3.0mm  
 Projection

Customer Client	Date
Drawn By / Dessiné Par: BoxCad	Date: 1/23/2007
Material / Matière: See Part List	
Color / Couleur: See Part List	Finish / Fini: See Part List

Qty	Part Number	Rev	Description	Material	Color	Finish
1	881 SP1612G-P	0	881 SP - Inner Panel Part	12 Ga Galvanized	Unpainted	Galvanized

Parts List

Description: 881 SP - Inner Panel		Detail Rev.	
Part Number / Numéro Pièce: <b>881 SP1612G</b>		Rev.:	1
		0	2

This drawing is confidential and must not be reproduced or used without the consent of EXM

Ce dessin est confidentiel et ne doit pas être reproduit ou utilisé sans le consentement de EXM

Table 1			FRONT VIEW
CUT-OUT	XDIM	YDIM	DESCRIPTION
1	0.875	1.875	GROUND HOLE (RND Ø0.290)
2	9.125	1.875	GROUND HOLE (RND Ø0.290)
3	0.875	12.125	GROUND HOLE (RND Ø0.290)
4	9.125	12.125	GROUND HOLE (RND Ø0.290)

All knockouts are actual size / Les disques défonçables sont grandeur réel

No.	Revisions	Date	By/Par



Isometric View

FRONT

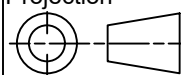
 Tél: (450) 979-4373 Fax: (450) 979-4626 www.exmweb.com		Flatness Aplatissement Max 3.0mm Projection 
Customer Client	Date	
Drawn By Dessiné Par	BoxCad	Date 1/23/2007
Material Matière	See Part List	
Color Couleur	See Part List	Finish Fini See Part List
Description 881 SP - Inner Panel		Detail Rev.
Part Number Numéro Pièce	881 SP1612G	Rev. 2 0