

This drawing is confidential and must not be reproduced or used without the consent of EXM

Ce dessin est confidentiel et ne doit pas être reproduit ou utilisé sans le consentement de EXM



TOP



BACK

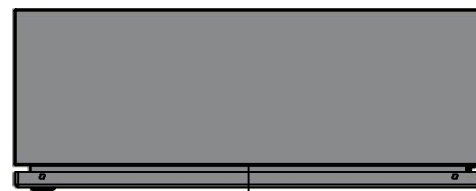

BOTTOM

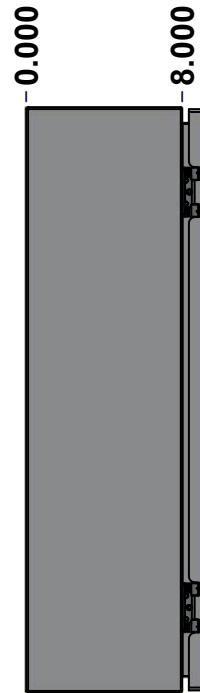

LEFT

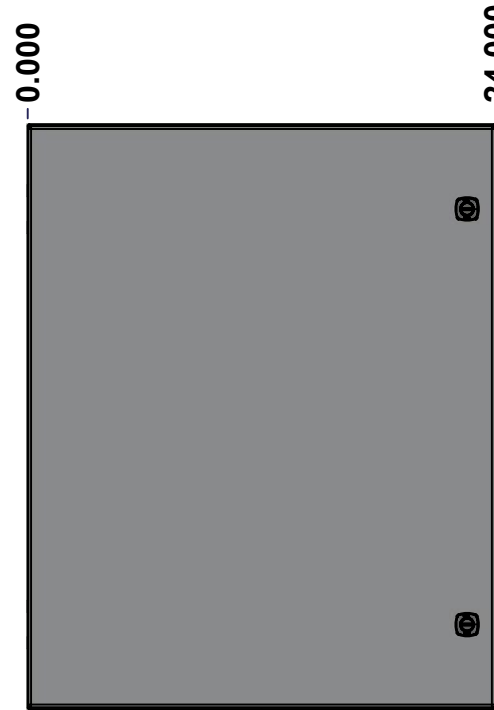

FRONT

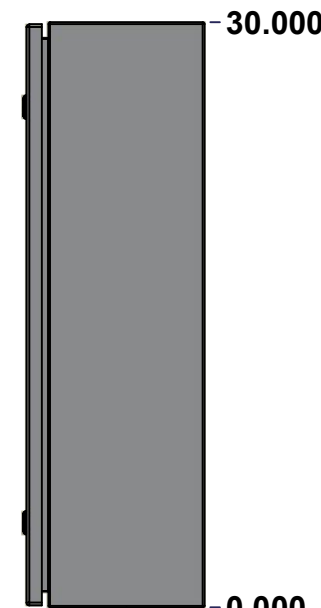

RIGHT

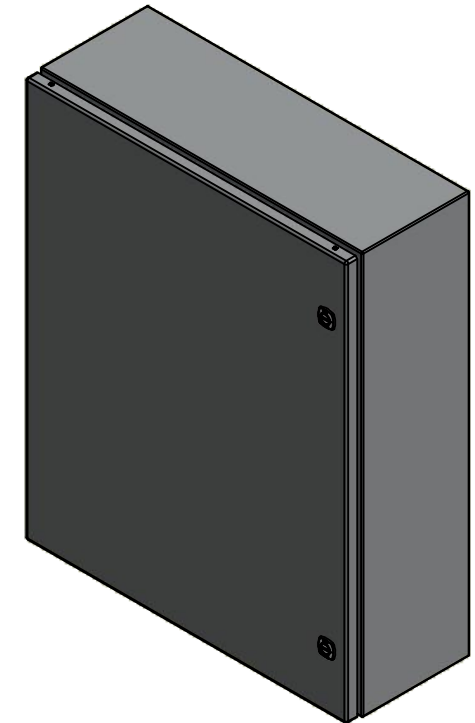

Isometric View

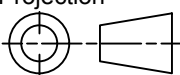

No.	Revisions	Date	By/Par

 Tél: (450) 979-4373 Fax: (450) 979-4626 www.exmweb.com		Flatness Aplatissement Max 3.0mm Projection 
Customer Client	Date	
Drawn By Dessiné Par	BoxCad: BoxCad	Date 17-Jun-22
Material Matière	16 Ga Stainless Steel 304 (1.4mm)	
Color Couleur	Asa-61 Grey	Finish Fini Smooth
Description	Detail Rev.	
5412ESSP 30" x 24" x 8" Assembly		
Part Number Numéro Pièce	Rev. 0	1 9
SEE BILL OF MATERIAL ON LAST PAGE		
5412ESSP302408NOIP		

This drawing is confidential and must not be reproduced or used without the consent of EXM

Ce dessin est confidentiel et ne doit pas être reproduit ou utilisé sans le consentement de EXM

NOTE	
ITEM	DESCRIPTION
1	NEMA 4X Enclosure
2	C/W Standard ground studs on box and cover
3	C/W Standard door stiffener
4	W/O Inner panel
5	C/W Standard inner panel mounting studs

No.	Revisions	Date	By/Par

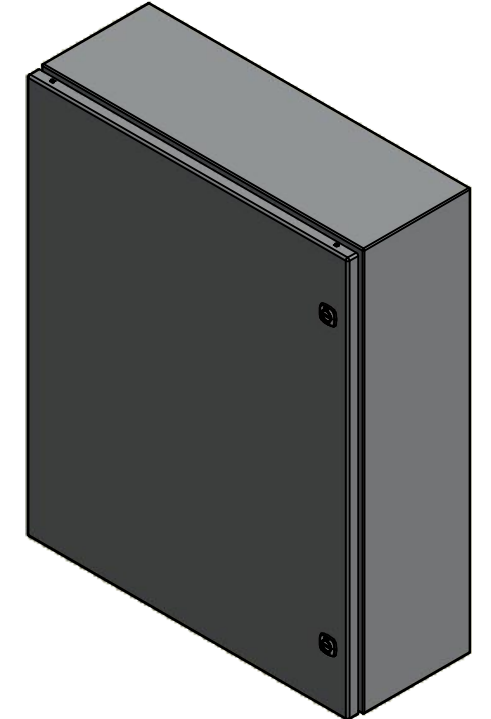

Isometric View

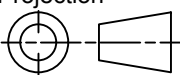

 Tél: (450) 979-4373 Fax: (450) 979-4626 www.exmweb.com	Flatness Aplatissement
	Max 3.0mm
Projection	
Customer Client	Date
Drawn By Dessiné Par BoxCad: BoxCad	Date 17-Jun-22
Material Matière	16 Ga Stainless Steel 304 (1.4mm)

PACKING		
ITEM	QTY	DESCRIPTION
Cardboard sleeve	2	Top and Bottom
Cardboard strip	2	Between back of enclosure and inner panel
Plastic bag	1	To protect cover surface and inside gasket
Plastic strap - Black	2	To Squeeze the 2 cardboard sleeve together
Packaging label	1	White label with product number

1	880 PP	6	Self Adhesive Print Pocket
1	STK-K-01800	5	5412 ES Accessory Kit
1	5412ESSP302408NOIPC	0	5412ESSP 30" x 24" Cover
1	5412ESSP302408NOIPB	0	5412ESSP 30" x 24" x 8" Body
2	STK-Q-04051-07	8	M6 x 7mm Stainless Steel Hexagon Socket Head Machine Screw with Nyseal
Qty	Part Number	Rev	Description
Parts List			

Color Couleur	Asa-61 Grey	Finish Fini	Smooth
Description	5412ESSP 30" x 24" x 8" Assembly		
Part Number Numéro Pièce	5412ESSP302408NOIP		Rev. 0
			2 9

This drawing is confidential and must not be reproduced or used without the consent of EXM

Ce dessin est confidentiel et ne doit pas être reproduit ou utilisé sans le consentement de EXM



TOP

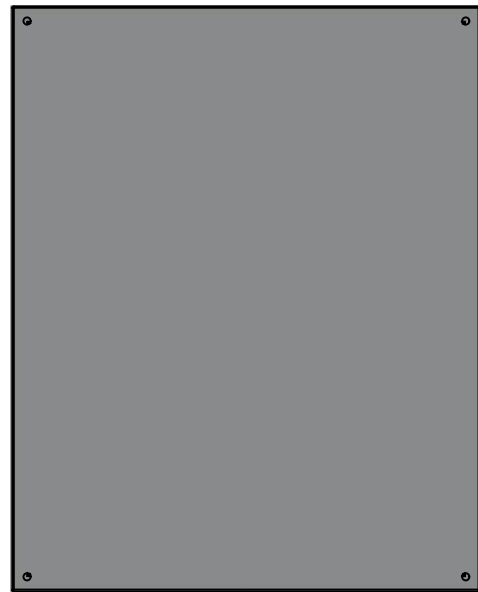

BACK

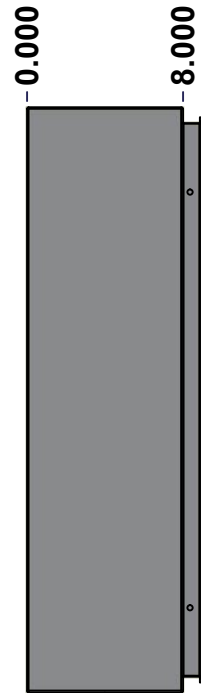

LEFT

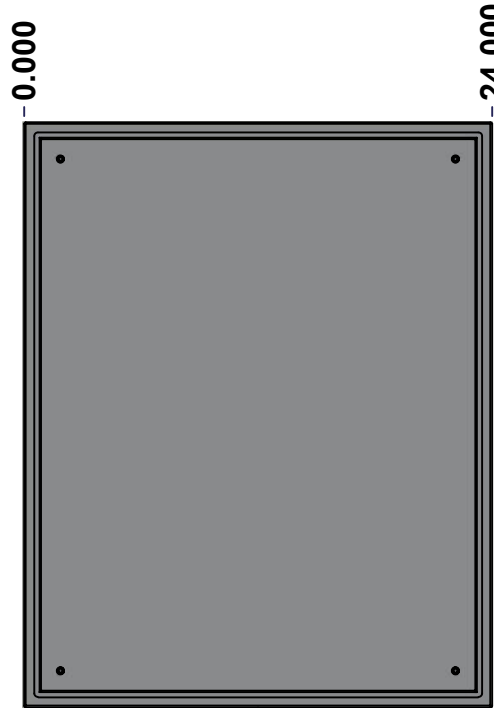

FRONT

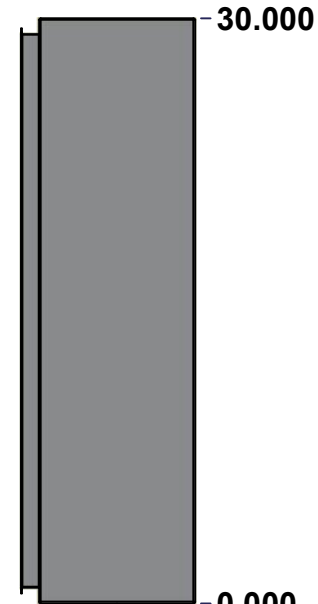

RIGHT



BOTTOM

No.	Revisions	Date	By/Par

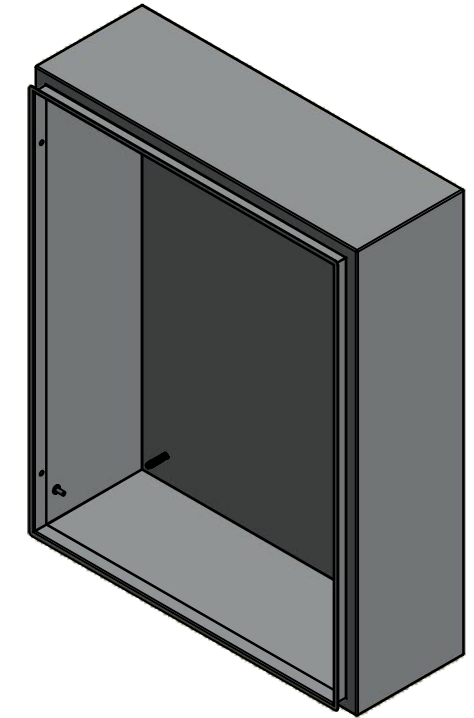

Isometric View



Tél: (450) 979-4373
 Fax: (450) 979-4626
www.exmweb.com

Flatness
Aplatissement

Max 3.0mm

Projection

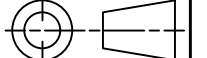

Customer Client	Date
Drawn By Dessiné Par BoxCad: BoxCad	Date 17-Jun-22
Material Matière 16 Ga Stainless Steel 304 (1.4mm)	
Color Couleur Asa-61 Grey	Finish Fini Smooth
Description 5412ESSP 30" x 24" x 8" Body	Detail Rev.
Part Number Numéro Pièce 5412ESSP302408NOIPB	Rev. 0
	3 9

SEE BILL OF MATERIAL ON LAST PAGE

This drawing is confidential and must not be reproduced or used without the consent of EXM

Ce dessin est confidentiel et ne doit pas être reproduit ou utilisé sans le consentement de EXM

STANDARD FEATURES ARE NOT LISTED IN THIS HOLE TABLE			
HOLE TABLE - LEFT VIEW (CUSTOM FEATURE ONLY)			
CUT-OUT	XDIM	YDIM	DESCRIPTION
1	6.500	2.000	GND STUD M6 x 16mm (Inside)

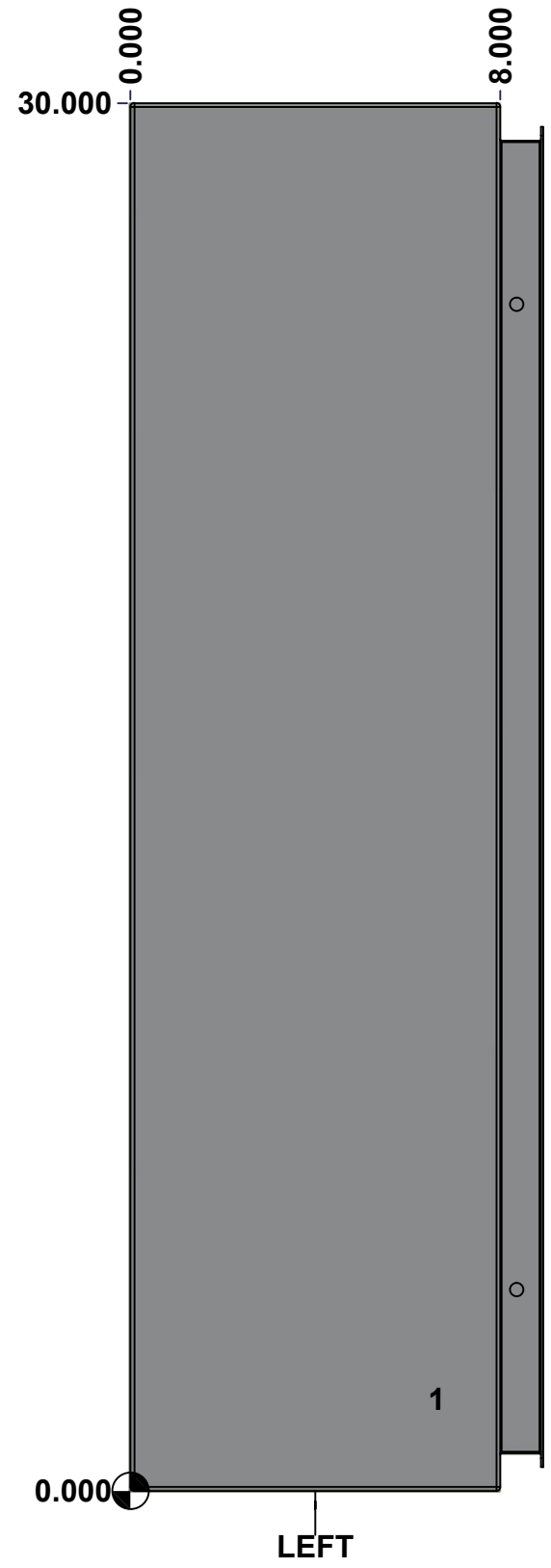

	Description	Status
	5412ESSP 30" x 24" x 8" Body	(NULL)
	Part Number Numéro Pièce	Rev.
	5412ESSP302408NOIPB	0 / 4 9

This drawing is confidential and must not be reproduced or used without the consent of EXM

Ce dessin est confidentiel et ne doit pas être reproduit ou utilisé sans le consentement de EXM

STANDARD FEATURES ARE NOT LISTED IN THIS HOLE TABLE

HOLE TABLE - BACK VIEW (CUSTOM FEATURE ONLY)

CUT-OUT	XDIM	YDIM	DESCRIPTION
1	1.875	1.875	IP STUD M8 x 35mm (Inside)
2	1.875	28.125	IP STUD M8 x 35mm (Inside)
3	22.125	28.125	IP STUD M8 x 35mm (Inside)
4	22.125	1.875	IP STUD M8 x 35mm (Inside)

5	23.250	0.750	RND Ø0.390
6	23.250	29.250	RND Ø0.390
7	0.750	29.250	RND Ø0.390
8	0.750	0.750	RND Ø0.390

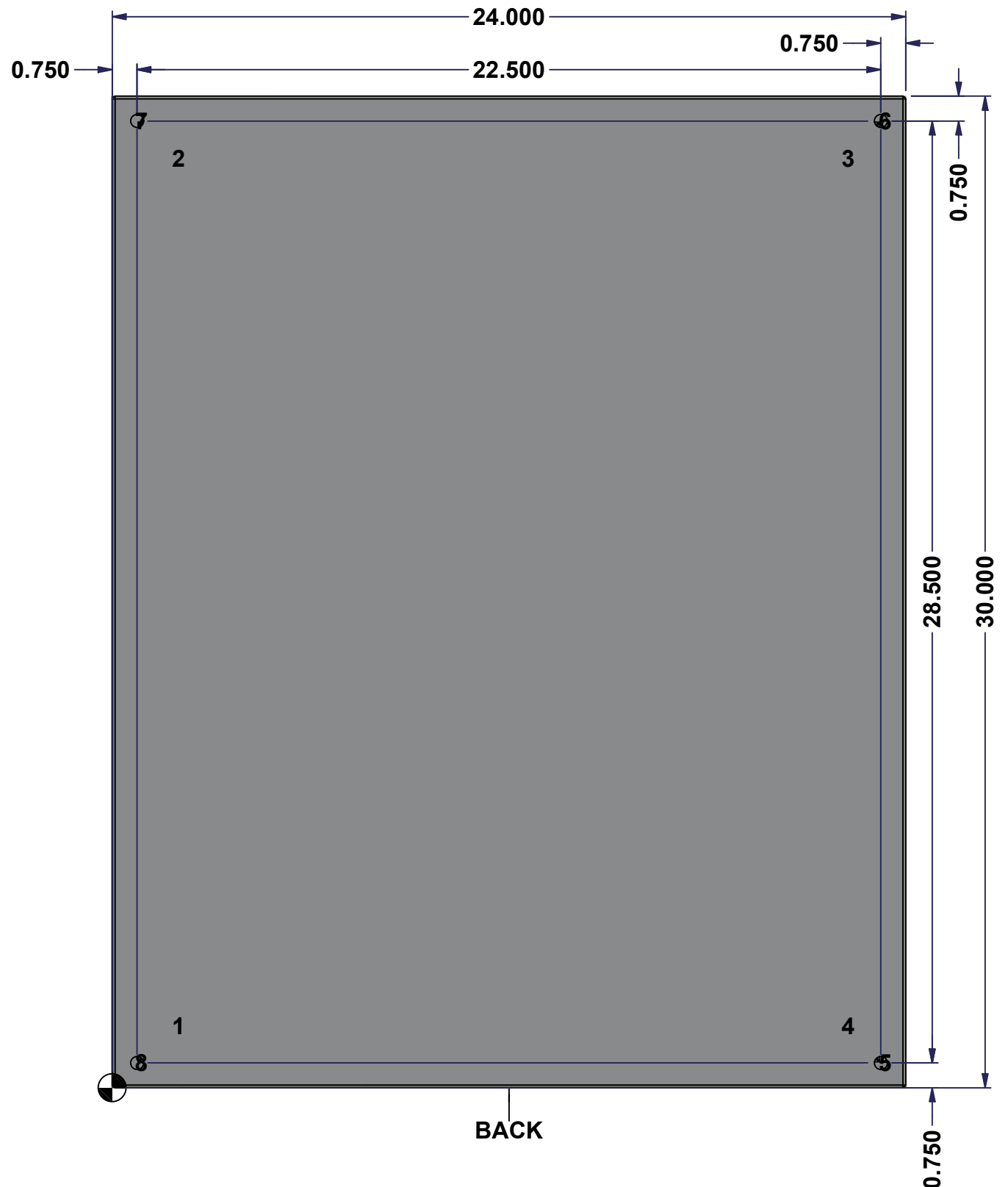

	Description	Status
	5412ESSP 30" x 24" x 8" Body	(NULL)
	Part Number Numéro Pièce	Rev.
	5412ESSP302408NOIPB	0
		5
		9

This drawing is confidential and must not be reproduced or used without the consent of EXM

Ce dessin est confidentiel et ne doit pas être reproduit ou utilisé sans le consentement de EXM

No.	Revisions	Date	By/Par

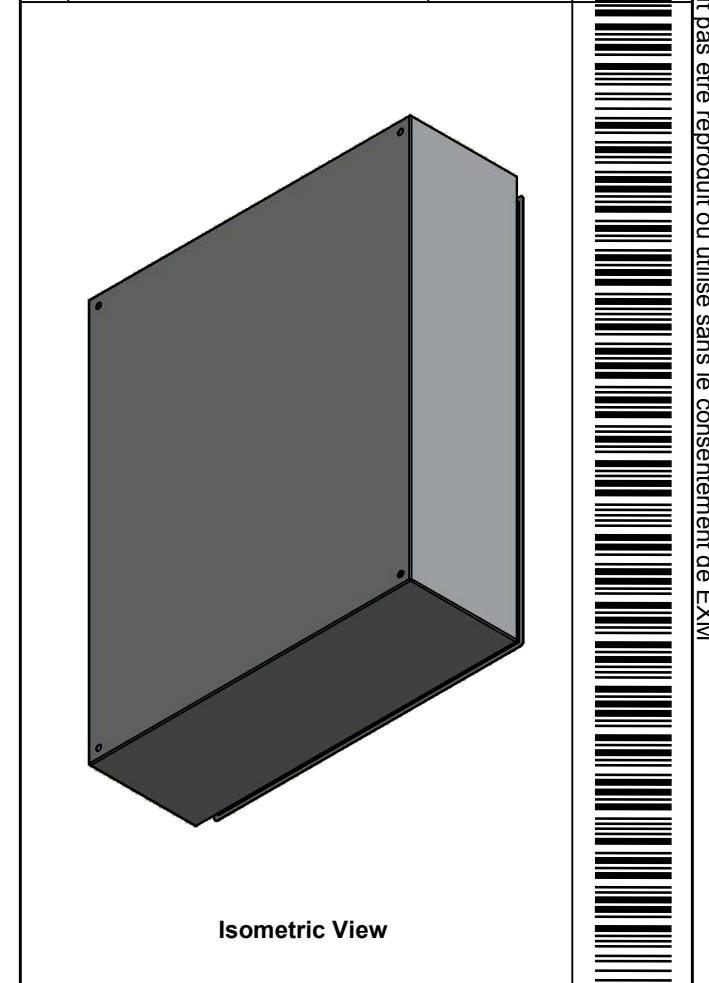

Tél: (450) 979-4373 Fax: (450) 979-4626 www.exmweb.com		Flatness / Aplatissement	
		Max 3.0mm	
Customer / Client		Date	
Drawn By / Dessiné Par: BoxCad: BoxCad		Date: 17-Jun-22	
Material / Matière: 16 Ga Stainless Steel 304 (1.4mm)			
Color / Couleur: Asa-61 Grey		Finish / Fini: Smooth	
Description: 5412ESSP 30" x 24" x 8" Body			Detail Rev.
Part Number / Numéro Pièce: 5412ESSP302408NOIPB			Rev. 0

1	STK-Q-16085	0	Ground Stud M6 x 16mm Stainless Steel
1	STK-P-02400S	0	Powder Paint (Asa-61 Grey / Smooth)
4	STK-Q-16020	1	Stud M8 x 35mm Stainless Steel
1	5412ESSP302408NOIPB-P	0	5412ESSP 30" x 24" x 8" Body Part
Qty	Part Number	Rev	Description
Parts List			

6
9

This drawing is confidential and must not be reproduced or used without the consent of EXM

Ce dessin est confidentiel et ne doit pas être reproduit ou utilisé sans le consentement de EXM



TOP

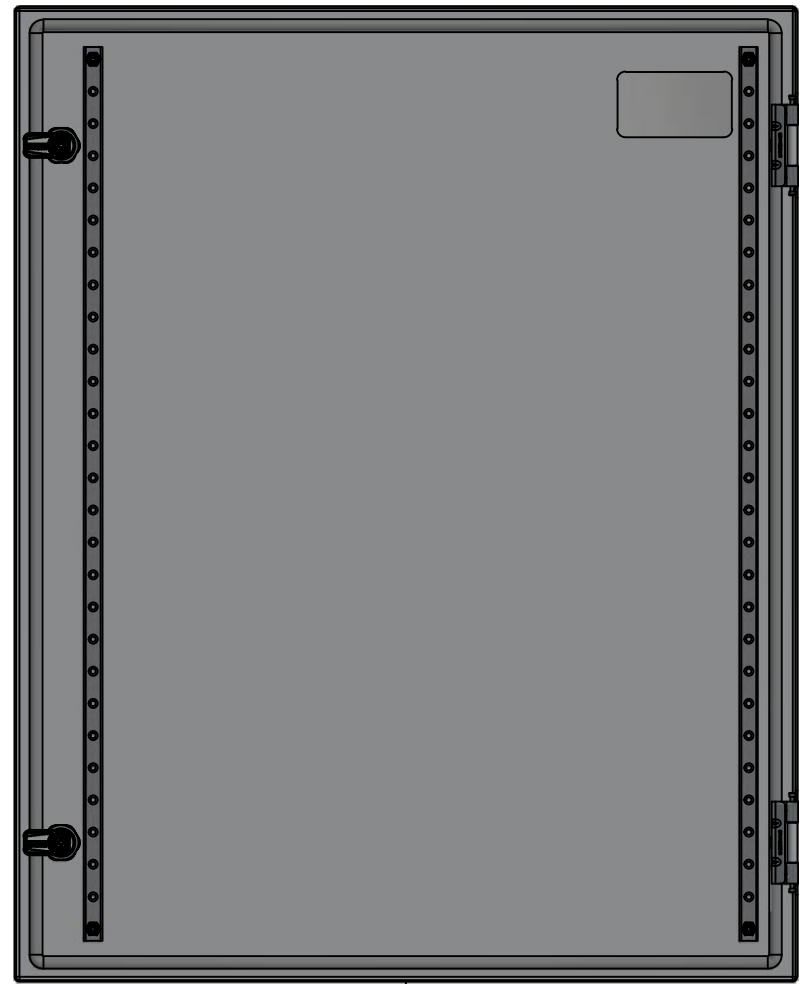

BACK



BOTTOM

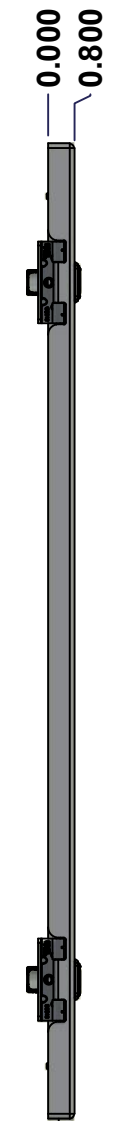

LEFT

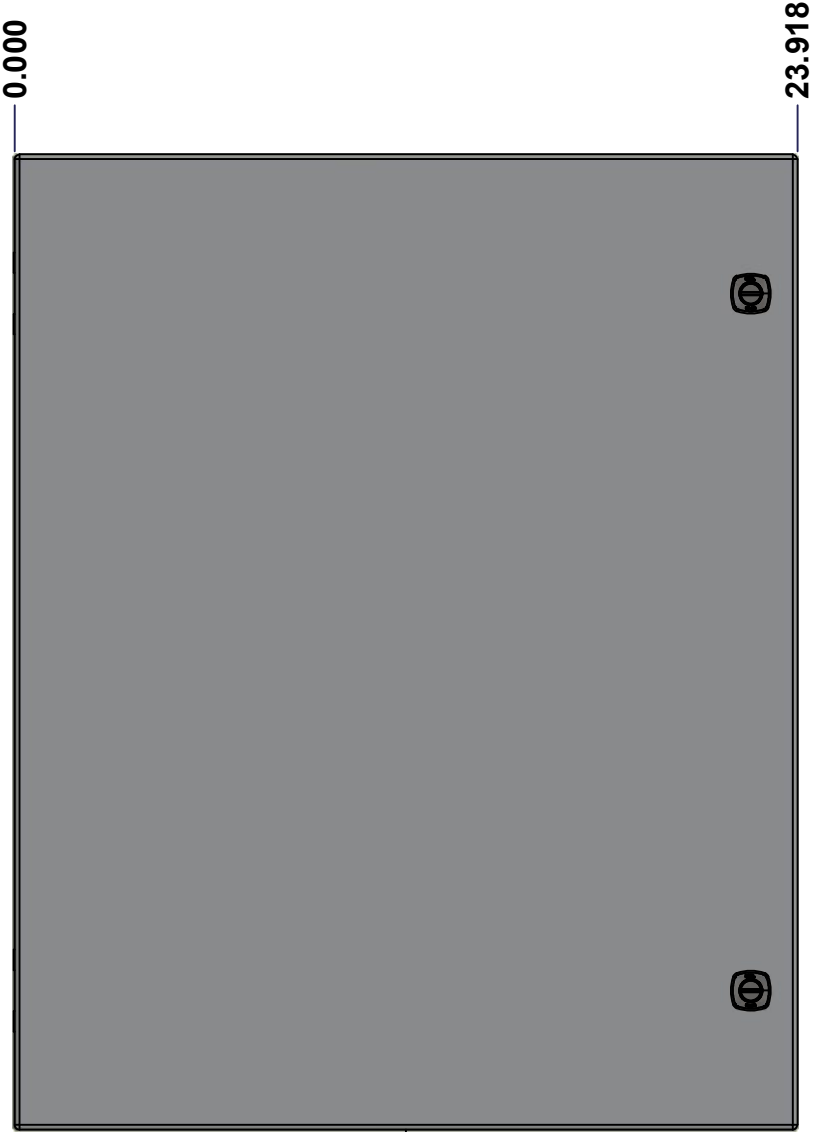

FRONT

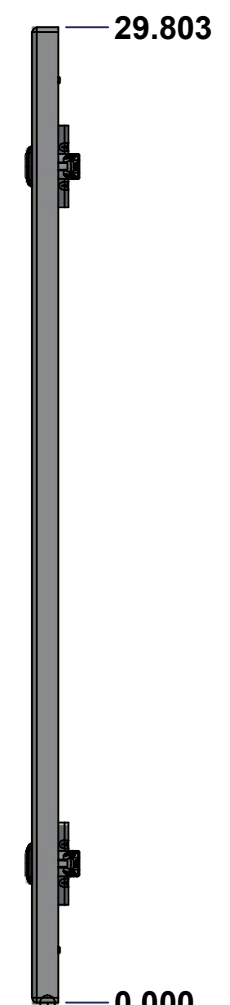

RIGHT

No.	Revisions	Date	By/Par

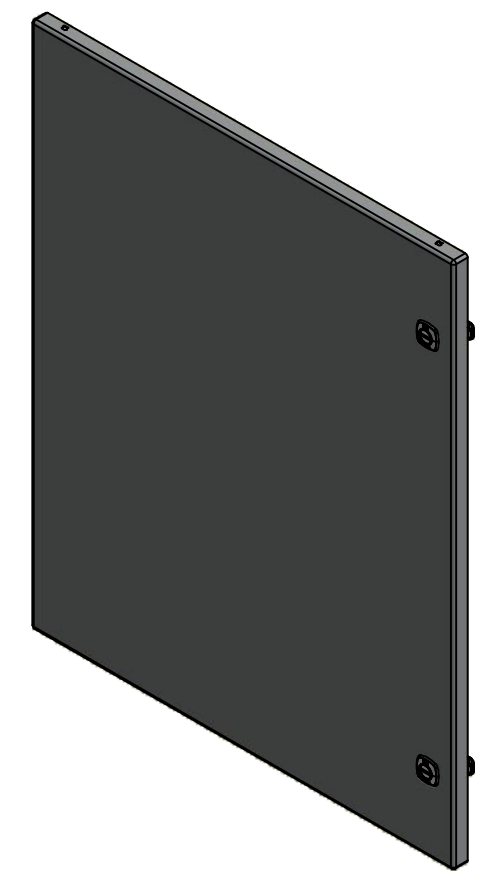

Isometric View

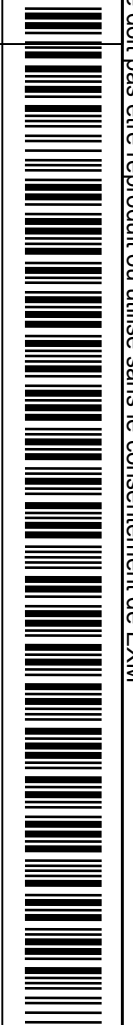

Tél: (450) 979-4373
 Fax: (450) 979-4626
www.exmweb.com

Flatness
Aplatissement
Max 3.0mm
Projection

Customer Client	Date
Drawn By Dessiné Par BoxCad: BoxCad	Date 17-Jun-22
Material Matière 16 Ga Stainless Steel 304 (1.4mm)	
Color Couleur Asa-61 Grey	Finish Fini Smooth
Description 5412ESSP 30" x 24" Cover	Detail Rev.
Part Number Numéro Pièce 5412ESSP302408NOIPC	Rev. 7 0

SEE BILL OF MATERIAL ON LAST PAGE

This drawing is confidential and must not be reproduced or used without the consent of EXM

Ce dessin est confidentiel et ne doit pas être reproduit ou utilisé sans le consentement de EXM

STANDARD FEATURES ARE NOT LISTED IN THIS HOLE TABLE

HOLE TABLE - FRONT VIEW (CUSTOM FEATURE ONLY)

CUT-OUT	XDIM	YDIM	DESCRIPTION
1	1.486	1.614	STUD M6 x 18mm (Inside)
2	1.486	28.189	STUD M6 x 18mm (Inside)
3	21.517	28.189	STUD M6 x 18mm (Inside)
4	21.517	1.614	STUD M6 x 18mm (Inside)

5	3.750	26.803	LABEL_EXM (Inside)
6	22.494	25.553	LOCK 880 SCQ4-SLSS6 @ 0.0°
7	22.494	4.250	LOCK 880 SCQ4-SLSS6 @ 0.0°

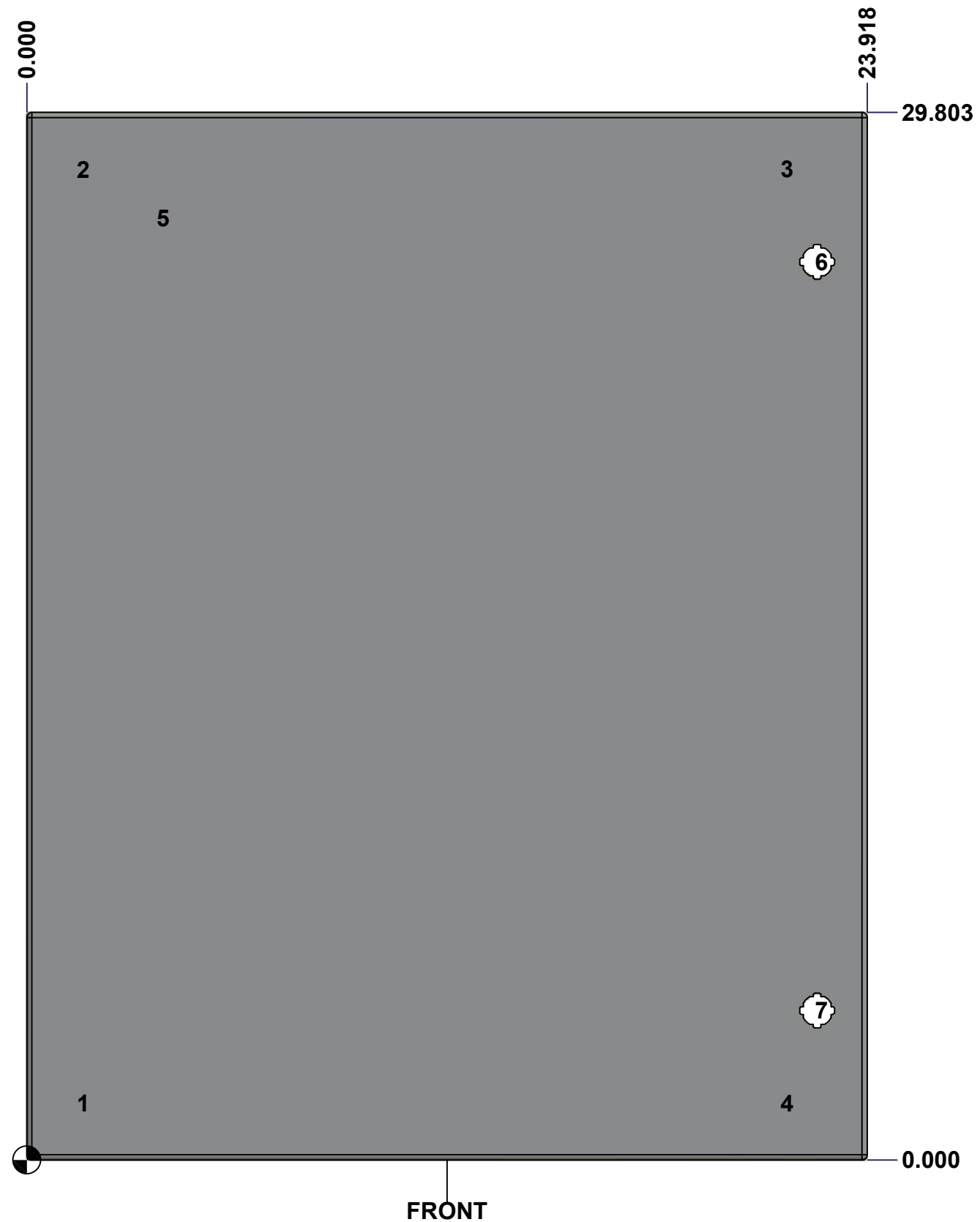

FRONT

	Description	Status
	5412ESSP 30" x 24" Cover	(NULL)
	Part Number Numéro Pièce	Rev.
	5412ESSP302408NOIPC	0
		8
		9

This drawing is confidential and must not be reproduced or used without the consent of EXM

Ce dessin est confidentiel et ne doit pas être reproduit ou utilisé sans le consentement de EXM

No.	Revisions	Date	By/Par

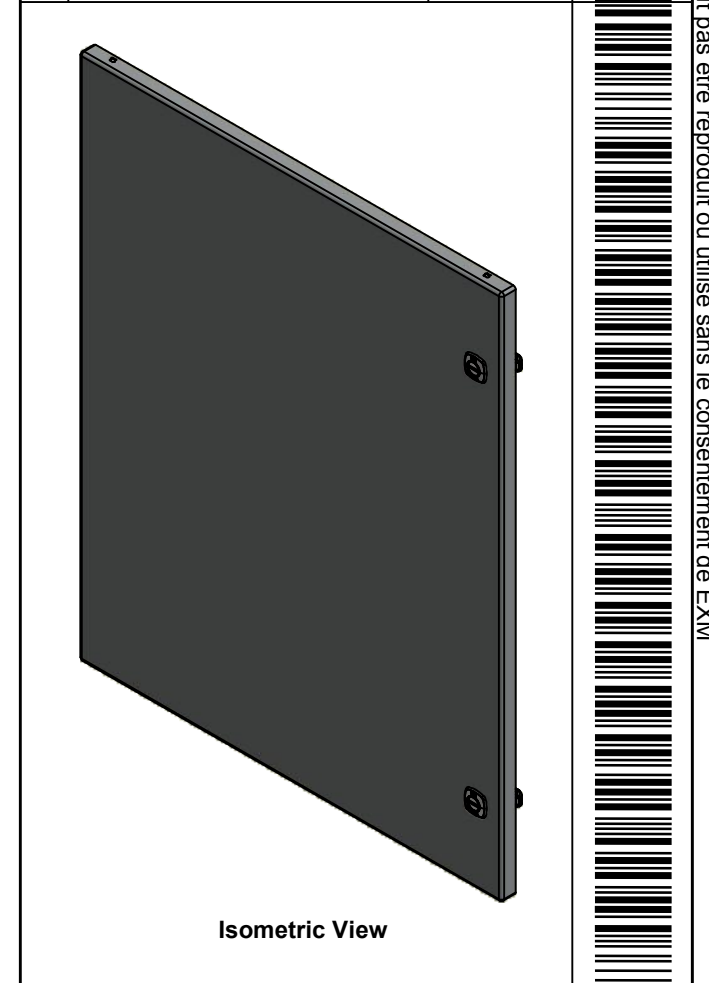

 Tél: (450) 979-4373
 Fax: (450) 979-4626
www.exmweb.com

Flatness / Aplatissement: Max 3.0mm
 Projection: 

Qty	Part Name	Rev	Description
1	STK-S-00100	0	3.5" x 2" Silver Milar Flexcon Sticker
1	STK-P-02400S	0	Powder Paint (Asa-61 Grey / Smooth)
2	STK-Q-46020-30	5	5412 ES Vertical Door Stiffener 30"
4	STK-Q-16070	1	Stud M6 x 18mm Stainless steel
1	5412ESSP302408NOIPG	0	5412ESSP 30" x 24" Cover Gasket Part
1	5412ESSP302408NOIPC-P	0	5412ESSP 30" x 24" Cover Part
2	STK-A-33016	0	5412 ESS Bended Hinge (Body Part)
2	880 SCQ4-SLSS6	7	5412 ESS 1/4 Turn Lock
4	STK-Q-07220	1	M6 Nylon Insert Lock Nut
Parts List			

Customer Client	Date
Drawn By / Dessiné Par: BoxCad: BoxCad	Date: 17-Jun-22
Material / Matière: 16 Ga Stainless Steel 304 (1.4mm)	
Color / Couleur: Asa-61 Grey	Finish / Fini: Smooth
Description: 5412ESSP 30" x 24" Cover	Detail Rev.
Part Number / Numéro Pièce: 5412ESSP302408NOIPC	Rev. 0 / 9