

This drawing is confidential and must not be reproduced or used without the consent of EXM

Ce dessin est confidentiel et ne doit pas être reproduit ou utilisé sans le consentement de EXM



TOP



BACK



BOTTOM

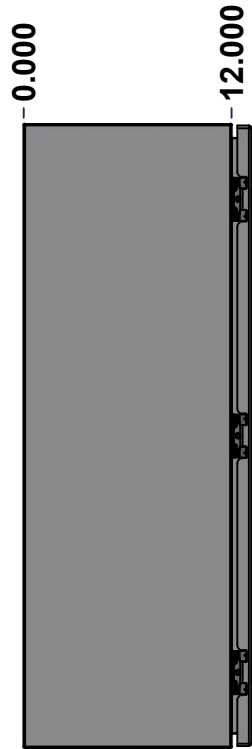

LEFT



FRONT

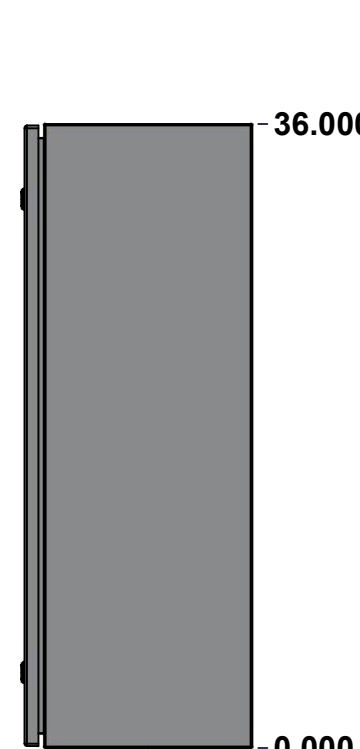

RIGHT

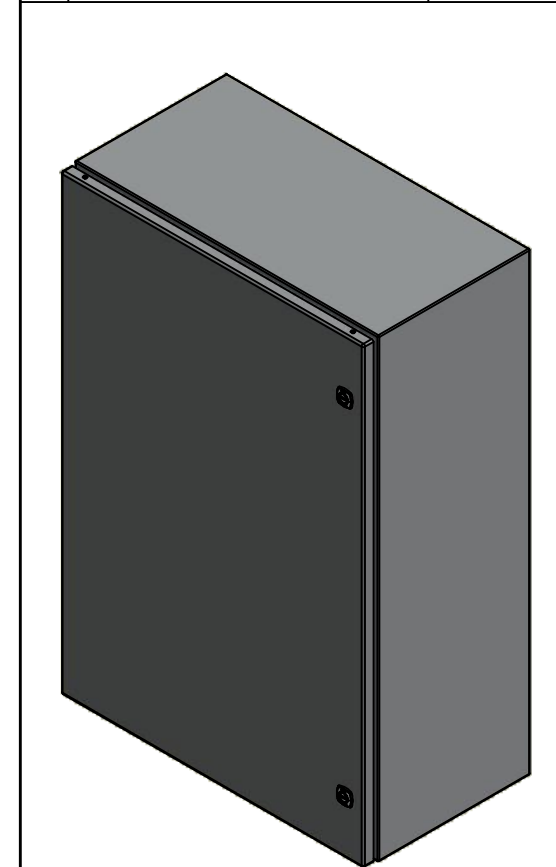

Isometric View

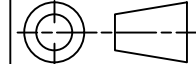

| No. | Revisions | Date | By/Par |
|-----|-----------|------|--------|
| | | | |
| | | | |
| | | | |
| | | | |
| | | | |

| | | |
|----------------------------------------------------------------------------------------------------------------------------------------------------------------------------------------|-----------------------------------|-----------------------------------------------------------------------------------------------------------------------------------------------|
|  Tél: (450) 979-4373 Fax: (450) 979-4626 www.exmweb.com | | Flatness Aplatissement Max 3.0mm Projection  |
| Customer Client | Date | |
| Drawn By Dessiné Par | BoxCad: BoxCad | Date 20-Jun-22 |
| Material Matière | 16 Ga Stainless Steel 304 (1.4mm) | |
| Color Couleur | Asa-61 Grey | Finish Fini Smooth |
| Description | Detail Rev. | |
| 5412ESSP 36" x 24" x 12" Assembly | | |
| Part Number Numéro Pièce | Rev. | 1 |
| 5412ESSP362412NOIP | 0 | 9 |

SEE BILL OF MATERIAL ON LAST PAGE

This drawing is confidential and must not be reproduced or used without the consent of EXM

Ce dessin est confidentiel et ne doit pas être reproduit ou utilisé sans le consentement de EXM

| NOTE | |
|------|--------------------------------------------|
| ITEM | DESCRIPTION |
| 1 | NEMA 4X Enclosure |
| 2 | C/W Standard ground studs on box and cover |
| 3 | C/W Standard door stiffener |
| 4 | W/O Inner panel |
| 5 | C/W Standard inner panel mounting studs |

| No. | Revisions | Date | By/Par |
|-----|-----------|------|--------|
| | | | |
| | | | |
| | | | |
| | | | |
| | | | |
| | | | |

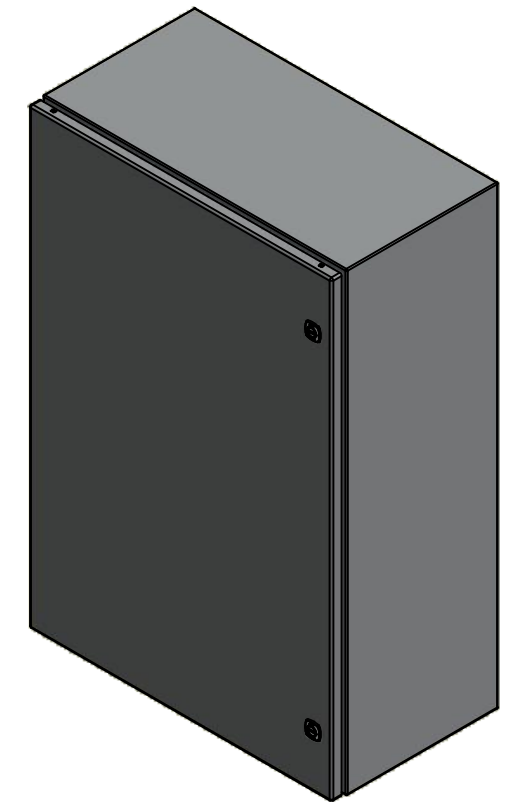

Isometric View





Tél: (450) 979-4373
Fax: (450) 979-4626
www.exmweb.com

Flatness
Aplatissement
Max 3.0mm
Projection

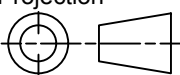

| | |
|----------------------------------------|-----------------------------------|
| Customer Client | Date |
| Drawn By Dessiné Par BoxCad: BoxCad | Date 20-Jun-22 |
| Material Matière | 16 Ga Stainless Steel 304 (1.4mm) |

| PACKING | | |
|-----------------------|-----|--------------------------------------------|
| ITEM | QTY | DESCRIPTION |
| Cardboard sleeve | 2 | Top and Bottom |
| Cardboard strip | 2 | Between back of enclosure and inner panel |
| Plastic bag | 1 | To protect cover surface and inside gasket |
| Plastic strap - Black | 2 | To Squeeze the 2 cardboard sleeve together |
| Packaging label | 1 | White label with product number |

| | | | |
|------------|---------------------|-----|------------------------------------------------------------------------|
| 1 | 880 PP | 6 | Self Adhesive Print Pocket |
| 1 | STK-K-01800 | 5 | 5412 ES Accessory Kit |
| 1 | 5412ESSP362412NOIPC | 0 | 5412ESSP 36" x 24" Cover |
| 1 | 5412ESSP362412NOIPB | 0 | 5412ESSP 36" x 24" x 12" Body |
| 3 | STK-Q-04051-07 | 8 | M6 x 7mm Stainless Steel Hexagon Socket Head Machine Screw with Nyseal |
| Qty | Part Number | Rev | Description |
| Parts List | | | |

| | | | |
|-----------------------------|-----------------------------------|----------------|----------|
| Color Couleur | Asa-61 Grey | Finish Fini | Smooth |
| Description | 5412ESSP 36" x 24" x 12" Assembly | | |
| Part Number Numéro Pièce | 5412ESSP362412NOIP | | Rev. 2 |
| | | | 0 |
| | | | 9 |

This drawing is confidential and must not be reproduced or used without the consent of EXM

Ce dessin est confidentiel et ne doit pas être reproduit ou utilisé sans le consentement de EXM



TOP

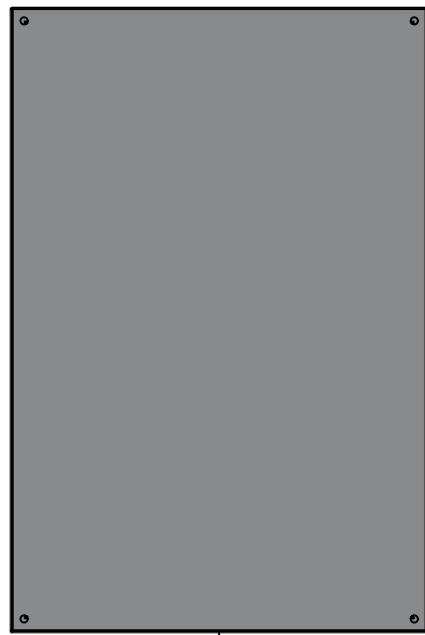

BACK



BOTTOM

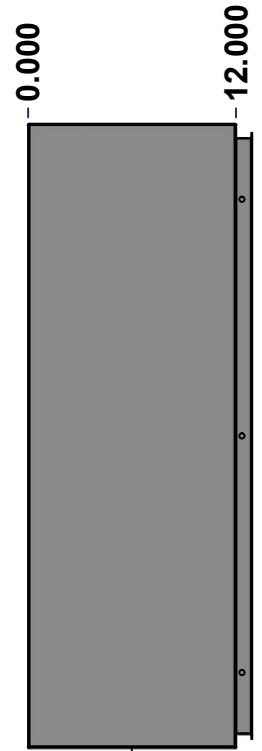

LEFT

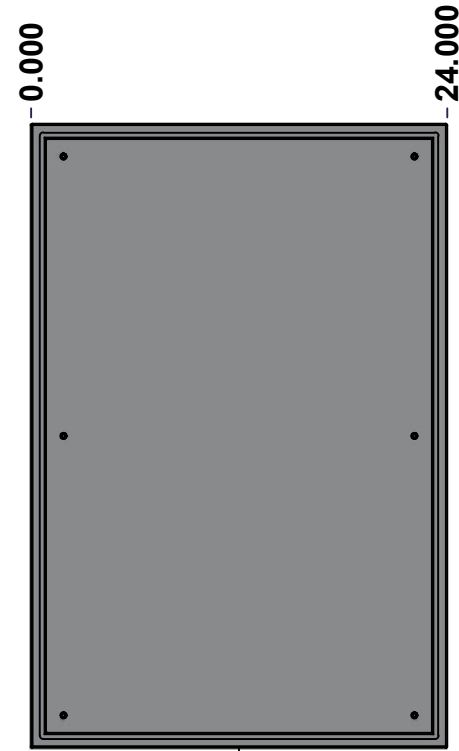

FRONT

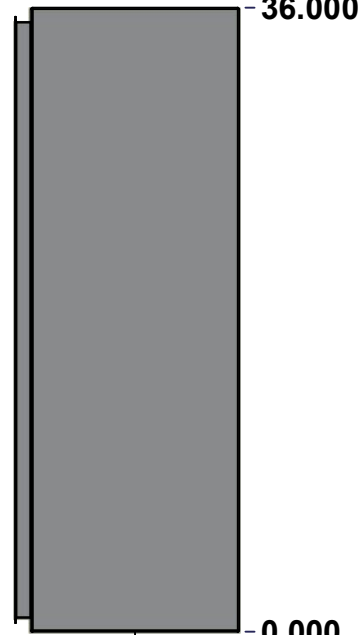

RIGHT

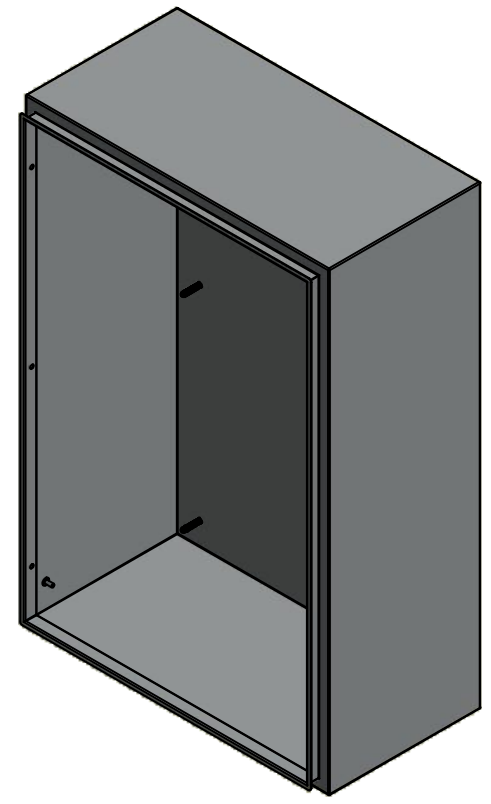

Isometric View

| No. | Revisions | Date | By/Par |
|-----|-----------|------|--------|
| | | | |
| | | | |
| | | | |
| | | | |
| | | | |



Tél: (450) 979-4373
 Fax: (450) 979-4626
www.exmweb.com

Flatness
Aplatissement
Max 3.0mm
Projection

| | |
|-------------------------------------------------------|-----------------------|
| Customer Client | Date |
| Drawn By Dessiné Par BoxCad: BoxCad | Date 20-Jun-22 |
| Material Matière 16 Ga Stainless Steel 304 (1.4mm) | |
| Color Couleur Asa-61 Grey | Finish Fini Smooth |
| Description 5412ESSP 36" x 24" x 12" Body | Detail Rev. |

| | | |
|-----------------------------|----------|---|
| Part Number Numéro Pièce | Rev. | 3 |
| 5412ESSP362412NOIPB | 0 | 9 |

SEE BILL OF MATERIAL ON LAST PAGE

This drawing is confidential and must not be reproduced or used without the consent of EXM

Ce dessin est confidentiel et ne doit pas être reproduit ou utilisé sans le consentement de EXM

| STANDARD FEATURES ARE NOT LISTED IN THIS HOLE TABLE | | | |
|------------------------------------------------------------|--------|-------|-----------------------------|
| HOLE TABLE - LEFT VIEW (CUSTOM FEATURE ONLY) | | | |
| CUT-OUT | XDIM | YDIM | DESCRIPTION |
| 1 | 10.500 | 2.000 | GND STUD M6 x 16mm (Inside) |

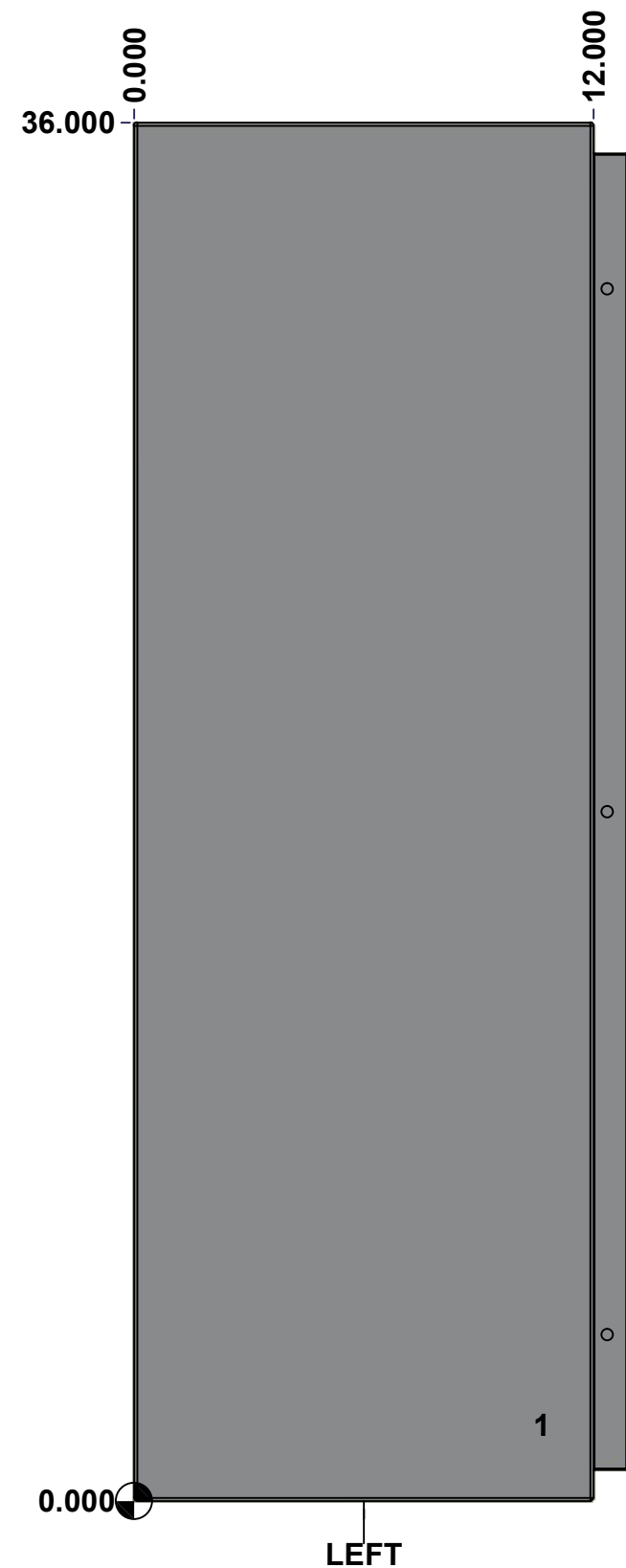

| | | |
|--|-------------------------------|-------------------|
| | Description | Status |
| | 5412ESSP 36" x 24" x 12" Body | (NULL) |
| | Part Number Numéro Pièce | Rev. |
| | 5412ESSP362412NOIPB | 0 / 4 9 |

This drawing is confidential and must not be reproduced or used without the consent of EXM

Ce dessin est confidentiel et ne doit pas être reproduit ou utilisé sans le consentement de EXM

STANDARD FEATURES ARE NOT LISTED IN THIS HOLE TABLE

HOLE TABLE - BACK VIEW (CUSTOM FEATURE ONLY)

| CUT-OUT | XDIM | YDIM | DESCRIPTION |
|---------|--------|--------|----------------------------|
| 1 | 1.875 | 1.875 | IP STUD M8 x 35mm (Inside) |
| 2 | 1.875 | 34.125 | IP STUD M8 x 35mm (Inside) |
| 3 | 22.125 | 34.125 | IP STUD M8 x 35mm (Inside) |
| 4 | 22.125 | 1.875 | IP STUD M8 x 35mm (Inside) |
| 5 | 1.875 | 18.000 | IP STUD M8 x 35mm (Inside) |
| 6 | 22.125 | 18.000 | IP STUD M8 x 35mm (Inside) |
| ----- | | | |
| 7 | 23.250 | 0.750 | RND Ø0.390 |
| 8 | 23.250 | 35.250 | RND Ø0.390 |
| 9 | 0.750 | 35.250 | RND Ø0.390 |
| 10 | 0.750 | 0.750 | RND Ø0.390 |

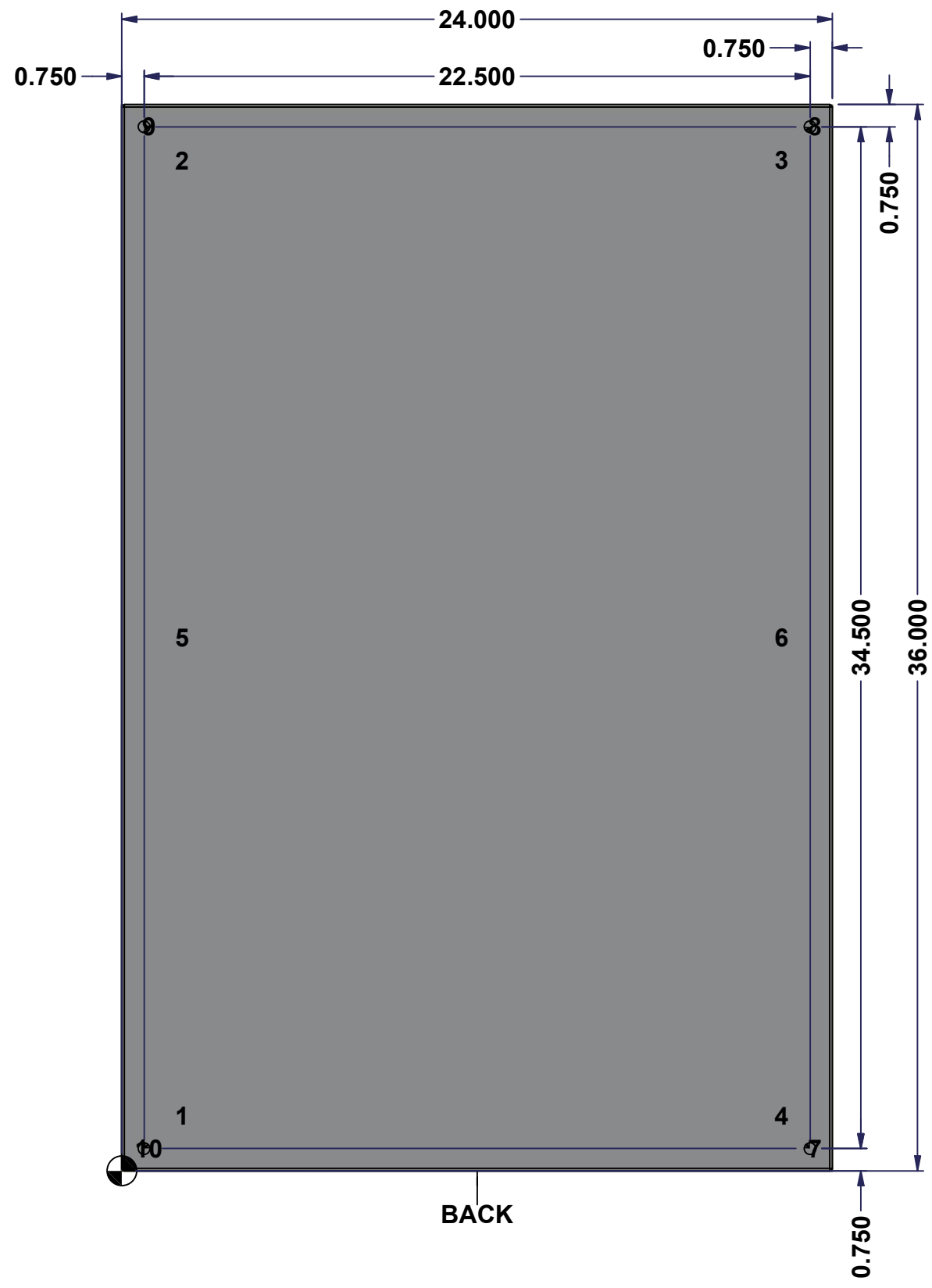

BACK

| | | |
|--|-------------------------------|--------------|
| | Description | Status |
| | 5412ESSP 36" x 24" x 12" Body | (NULL) |
| | Part Number Numéro Pièce | Rev. |
| | 5412ESSP362412NOIPB | 0 / 5 |
| | | 9 |

This drawing is confidential and must not be reproduced or used without the consent of EXM

Ce dessin est confidentiel et ne doit pas être reproduit ou utilisé sans le consentement de EXM

| No. | Revisions | Date | By/Par |
|-----|-----------|------|--------|
| | | | |
| | | | |
| | | | |
| | | | |
| | | | |

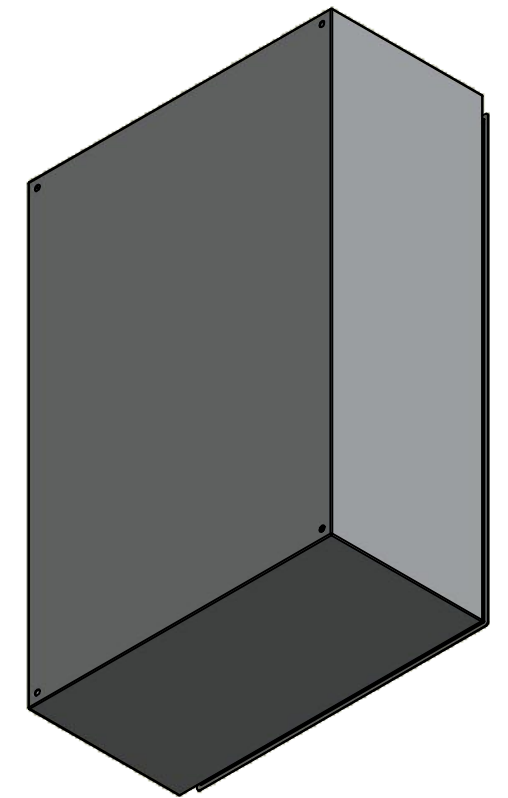

Isometric View



Tél: (450) 979-4373
 Fax: (450) 979-4626
www.exmweb.com

Flatness
Aplatissement

Max 3.0mm

Projection

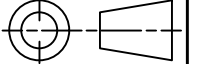

| | |
|-------------------------------------------------------|-----------------------|
| Customer Client | Date |
| Drawn By / Dessiné Par: BoxCad: BoxCad | Date: 20-Jun-22 |
| Material / Matière: 16 Ga Stainless Steel 304 (1.4mm) | |
| Color / Couleur: Asa-61 Grey | Finish / Fini: Smooth |

| 1 | STK-Q-16085 | 0 | Ground Stud M6 x 16mm Stainless Steel |
|------------|-----------------------|-----|---------------------------------------|
| 1 | STK-P-02400S | 0 | Powder Paint (Asa-61 Grey / Smooth) |
| 6 | STK-Q-16020 | 1 | Stud M8 x 35mm Stainless Steel |
| 1 | 5412ESSP362412NOIPB-P | 0 | 5412ESSP 36" x 24" x 12" Body Part |
| Qty | Part Number | Rev | Description |
| Parts List | | | |

| | |
|--------------------------------------------------------|---------------|
| Description: 5412ESSP 36" x 24" x 12" Body | Detail Rev. |
| Part Number / Numéro Pièce: 5412ESSP362412NOIPB | Rev. 0 |
| | 6 / 9 |

This drawing is confidential and must not be reproduced or used without the consent of EXM

Ce dessin est confidentiel et ne doit pas être reproduit ou utilisé sans le consentement de EXM



TOP

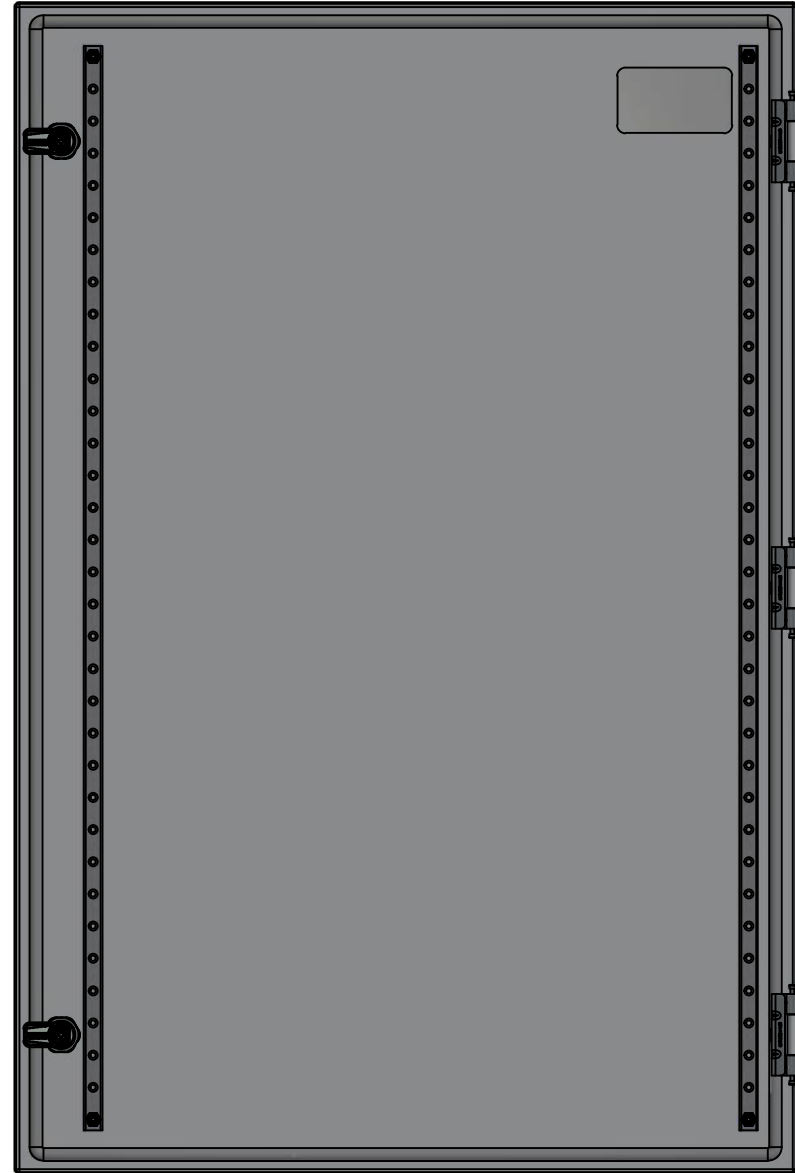

BACK



BOTTOM

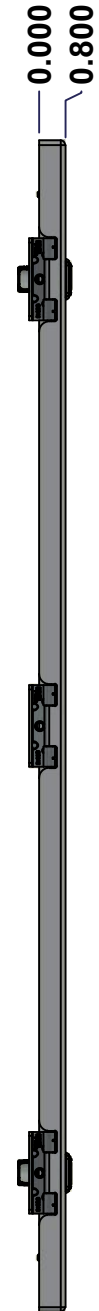

LEFT

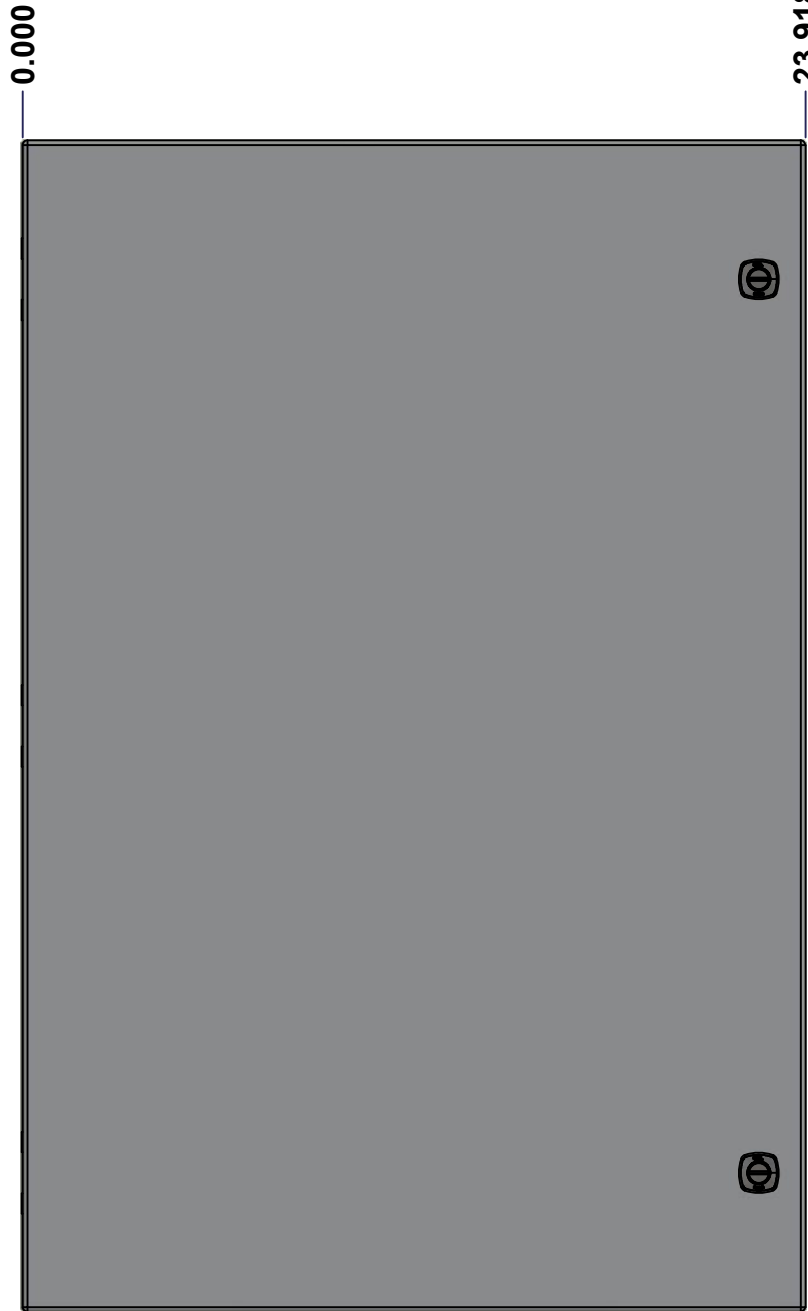

FRONT

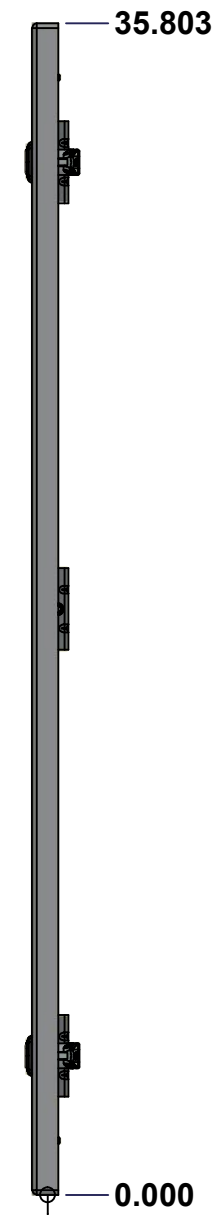

RIGHT

| No. | Revisions | Date | By/Par |
|-----|-----------|------|--------|
| | | | |
| | | | |
| | | | |
| | | | |
| | | | |



Isometric View



Tél: (450) 979-4373
 Fax: (450) 979-4626
www.exmweb.com

Flatness
Aplatissement

Max 3.0mm

Projection

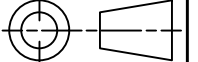

| | |
|-------------------------------------------------------|-----------------------|
| Customer Client | Date |
| Drawn By Dessiné Par BoxCad: BoxCad | Date 20-Jun-22 |
| Material Matière 16 Ga Stainless Steel 304 (1.4mm) | |
| Color Couleur Asa-61 Grey | Finish Fini Smooth |
| Description 5412ESSP 36" x 24" Cover | Detail Rev. |
| Part Number Numéro Pièce 5412ESSP362412NOIPC | Rev. 7 |
| | 0 |

SEE BILL OF MATERIAL ON LAST PAGE

This drawing is confidential and must not be reproduced or used without the consent of EXM

Ce dessin est confidentiel et ne doit pas être reproduit ou utilisé sans le consentement de EXM

STANDARD FEATURES ARE NOT LISTED IN THIS HOLE TABLE

HOLE TABLE - FRONT VIEW (CUSTOM FEATURE ONLY)

| CUT-OUT | XDIM | YDIM | DESCRIPTION |
|---------|--------|--------|----------------------------|
| 1 | 1.486 | 1.661 | STUD M6 x 18mm (Inside) |
| 2 | 1.486 | 34.142 | STUD M6 x 18mm (Inside) |
| 3 | 21.517 | 34.142 | STUD M6 x 18mm (Inside) |
| 4 | 21.517 | 1.661 | STUD M6 x 18mm (Inside) |
| ----- | | | |
| 5 | 3.750 | 32.803 | LABEL_EXM (Inside) |
| 6 | 22.494 | 31.553 | LOCK 880 SCQ4-SLSS6 @ 0.0° |
| 7 | 22.494 | 4.250 | LOCK 880 SCQ4-SLSS6 @ 0.0° |

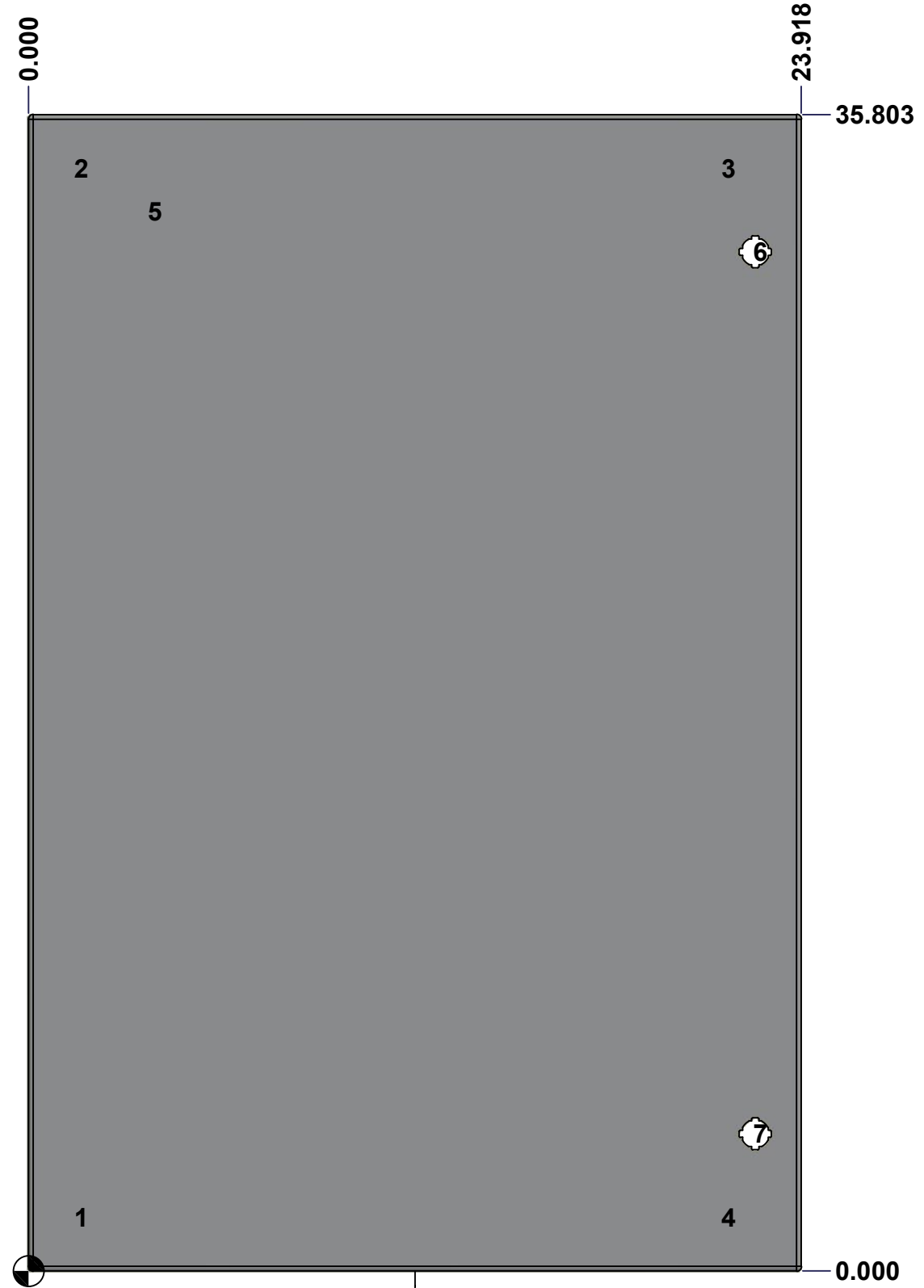

FRONT

| | | |
|--|-----------------------------|----------|
| | Description | Status |
| | 5412ESSP 36" x 24" Cover | (NULL) |
| | Part Number Numéro Pièce | Rev. |
| | 5412ESSP362412NOIPC | 0 |
| | | 8 |
| | | 9 |

This drawing is confidential and must not be reproduced or used without the consent of EXM

Ce dessin est confidentiel et ne doit pas être reproduit ou utilisé sans le consentement de EXM

| No. | Revisions | Date | By/Par |
|-----|-----------|------|--------|
| | | | |
| | | | |
| | | | |
| | | | |
| | | | |

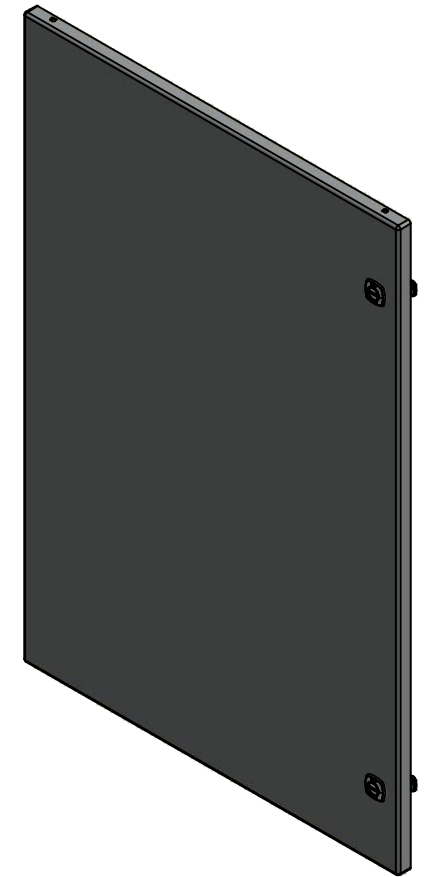

Isometric View



Tél: (450) 979-4373
 Fax: (450) 979-4626
www.exmweb.com

Flatness
Aplatissement
Max 3.0mm
Projection

| Qty | Part Name | Rev | Description |
|------------|-----------------------|-----|----------------------------------------|
| 1 | STK-S-00100 | 0 | 3.5" x 2" Silver Milar Flexcon Sticker |
| 1 | STK-P-02400S | 0 | Powder Paint (Asa-61 Grey / Smooth) |
| 2 | STK-Q-46020-36 | 5 | 5412 ES Vertical Door Stiffener 36" |
| 4 | STK-Q-16070 | 1 | Stud M6 x 18mm Stainless steel |
| 1 | 5412ESSP362412NOIPG | 0 | 5412ESSP 36" x 24" Cover Gasket Part |
| 1 | 5412ESSP362412NOIPC-P | 0 | 5412ESSP 36" x 24" Cover Part |
| 3 | STK-A-33016 | 0 | 5412 ESS Bended Hinge (Body Part) |
| 2 | 880 SCQ4-SLSS6 | 7 | 5412 ESS 1/4 Turn Lock |
| 4 | STK-Q-07220 | 1 | M6 Nylon Insert Lock Nut |
| Parts List | | | |

| | |
|-----------------------------------------------------------|-----------------------|
| Customer Client | Date |
| Drawn By Dessiné Par BoxCad: BoxCad | Date 20-Jun-22 |
| Material Matière 16 Ga Stainless Steel 304 (1.4mm) | |
| Color Couleur Asa-61 Grey | Finish Fini Smooth |
| Description 5412ESSP 36" x 24" Cover | Detail Rev. |
| Part Number Numéro Pièce 5412ESSP362412NOIPC | Rev. 0 |

9
9