

This drawing is confidential and must not be reproduced or used without the consent of EXM

Ce dessin est confidentiel et ne doit pas être reproduit ou utilisé sans le consentement de EXM

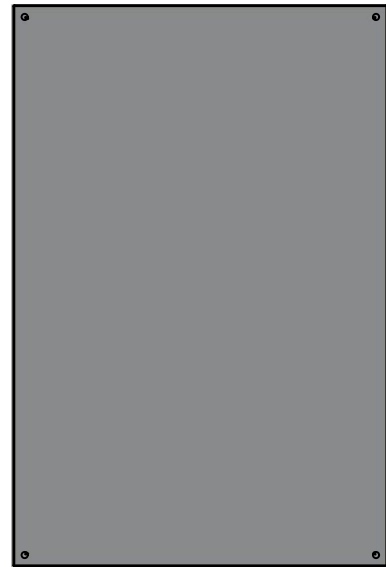

TOP



BACK



BOTTOM

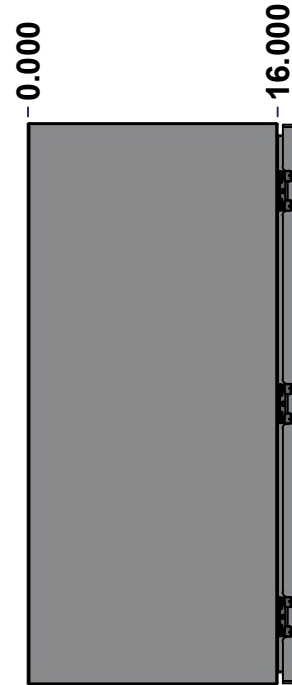

LEFT

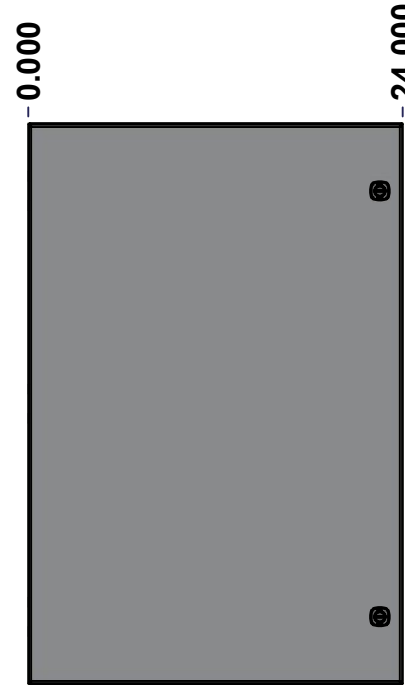

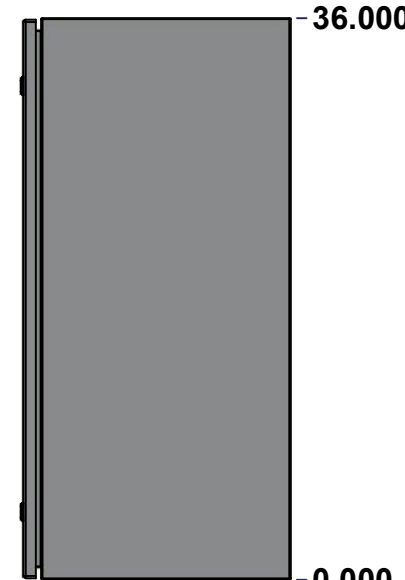

FRONT

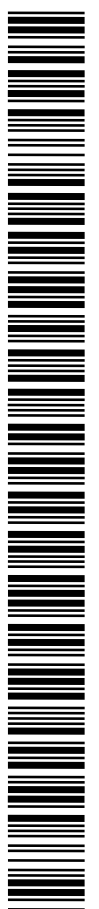
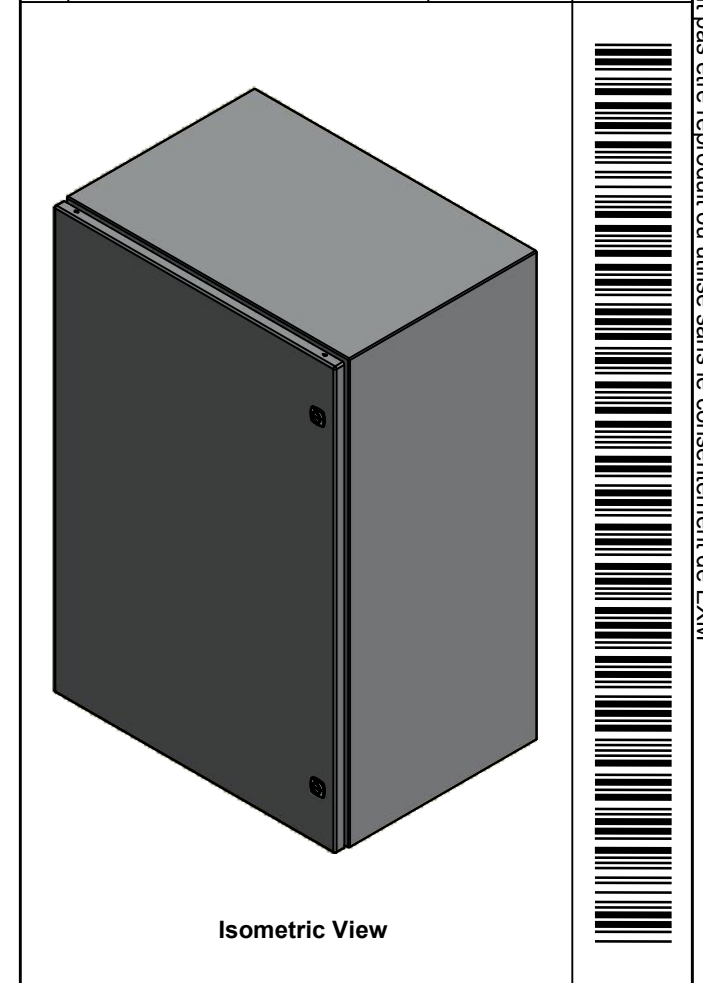

RIGHT

| No. | Revisions | Date | By/Par |
|-----|-----------|------|--------|
|     |           |      |        |
|     |           |      |        |
|     |           |      |        |
|     |           |      |        |
|     |           |      |        |

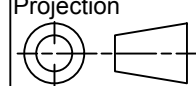

|  |  |   |             |
|--|--|---|-------------|
|  Tél: (450) 979-4373<br>Fax: (450) 979-4626<br><a href="http://www.exmweb.com">www.exmweb.com</a> |  | Flatness<br>Aplatissement   |             |
|  |  | Max 3.0mm   |             |
| Projection   |  |  |             |
| Customer<br>Client   |  | Date  |             |
| Drawn By<br>Dessiné Par BoxCad: BoxCad   |  | Date 07-Jul-22  |             |
| Material<br>Matière 16 Ga Stainless Steel 316 (1.4mm)  |  |   |             |
| Color<br>Couleur Asa-61 Grey   |  | Finish<br>Fini Smooth   |             |
| Description<br>5412ESSP 36" x 24" x 16" Assembly   |  |   | Detail Rev. |
| Part Number<br>Numéro Pièce 5412ESSP3624166  |  | Rev. 0  | 1/9         |

SEE BILL OF MATERIAL ON LAST PAGE

This drawing is confidential and must not be reproduced or used without the consent of EXM

Ce dessin est confidentiel et ne doit pas être reproduit ou utilisé sans le consentement de EXM

| NOTE |  |
|------|--|
| ITEM | DESCRIPTION                                |
| 1    | NEMA 4X Enclosure                          |
| 2    | C/W Standard ground studs on box and cover |
| 3    | C/W Standard door stiffener                |
| 4    | C/W Standard inner panel (Included)        |
| 5    | C/W Standard inner panel mounting studs    |

| No. | Revisions | Date | By/Par |
|-----|-----------|------|--------|
|     |           |      |        |
|     |           |      |        |
|     |           |      |        |
|     |           |      |        |
|     |           |      |        |
|     |           |      |        |

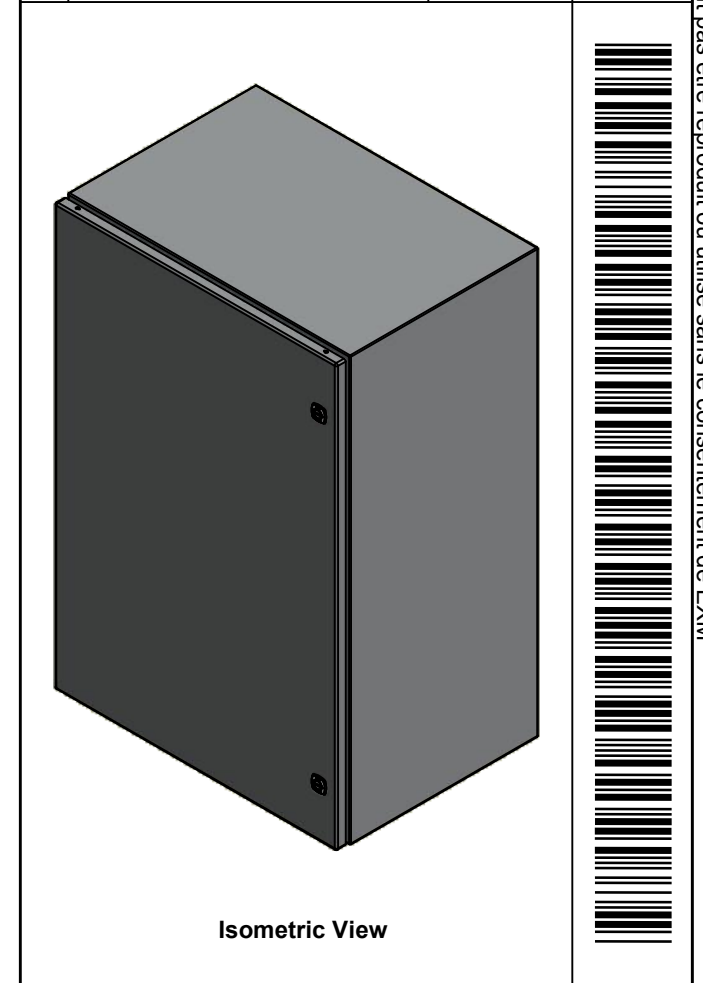

 Tél: (450) 979-4373  
 Fax: (450) 979-4626  
[www.exmweb.com](http://www.exmweb.com)

Flatness  
 Aplatissement  
 Max 3.0mm  
 Projection  

|                         |                |
|-------------------------|----------------|
| Customer Client         | Date           |
| Drawn By<br>Dessiné Par | Date 07-Jul-22 |

Material Matière 16 Ga Stainless Steel 316 (1.4mm)

|               |             |             |        |
|---------------|-------------|-------------|--------|
| Color Couleur | Asa-61 Grey | Finish Fini | Smooth |
|---------------|-------------|-------------|--------|

Description 5412ESSP 36" x 24" x 16" Assembly

|                             |          |   |
|-----------------------------|----------|---|
| Part Number<br>Numéro Pièce | Rev.     | 2 |
| <b>5412ESSP3624166</b>      | <b>0</b> | 9 |

| Qty        | Part Number      | Rev | Description  |
|------------|------------------|-----|--|
| 1          | 880 PP           | 6   | Self Adhesive Print Pocket   |
| 1          | STK-K-01800      | 5   | 5412 ES Accessory Kit  |
| 1          | 881 SP3624G      | 0   | 881 SP - Inner Panel   |
| 1          | 5412ESSP3624166C | 0   | 5412ESSP 36" x 24" Cover   |
| 6          | STK-Q-07310      | 2   | Flange Lock Nut M8   |
| 6          | STK-Q-07610      | 8   | M8 Plastic Spacer 22.2mm   |
| 1          | 5412ESSP3624166B | 0   | 5412ESSP 36" x 24" x 16" Body  |
| 3          | STK-Q-04051-07   | 8   | M6 x 7mm Stainless Steel Hexagon Socket Head Machine Screw with Nyseal |
| Parts List |                  |     |  |

| PACKING               |     |  |
|-----------------------|-----|--|
| ITEM                  | QTY | DESCRIPTION                                |
| Cardboard sleeve      | 2   | Top and Bottom                             |
| Cardboard strip       | 2   | Between back of enclosure and inner panel  |
| Plastic bag           | 1   | To protect cover surface and inside gasket |
| Plastic strap - Black | 2   | To Squeeze the 2 cardboard sleeve together |
| Packaging label       | 1   | White label with product number            |

This drawing is confidential and must not be reproduced or used without the consent of EXM

Ce dessin est confidentiel et ne doit pas être reproduit ou utilisé sans le consentement de EXM



TOP

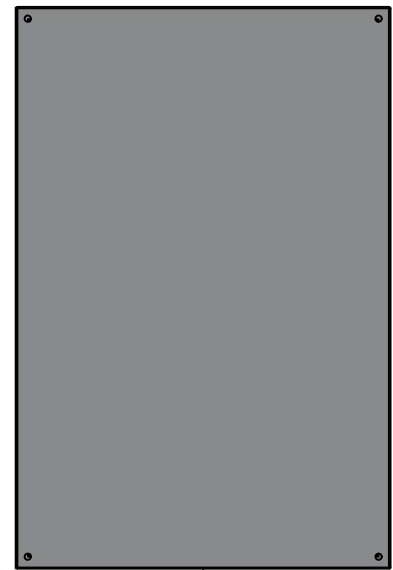

BACK



BOTTOM

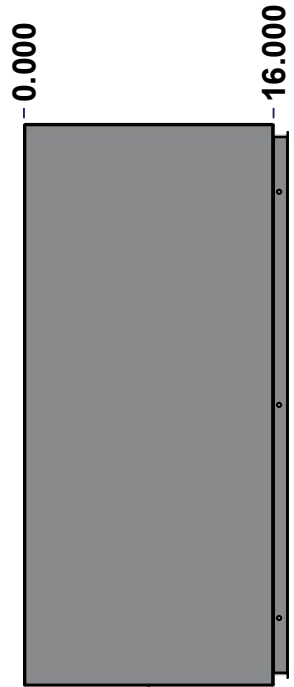

LEFT

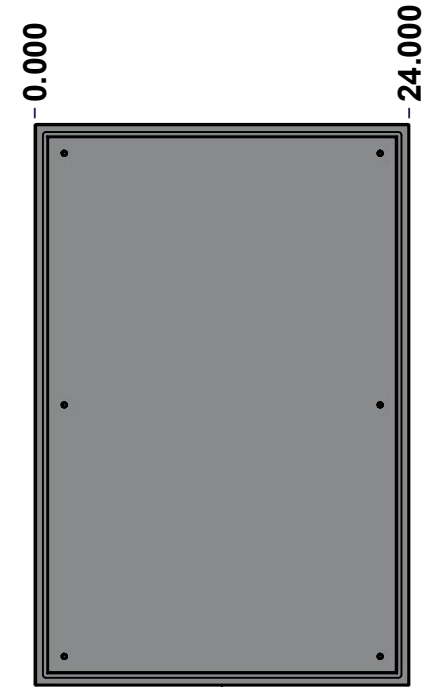

FRONT

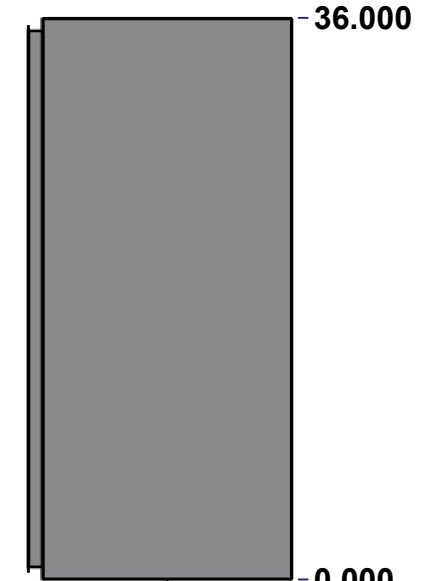

RIGHT

| No. | Revisions | Date | By/Par |
|-----|-----------|------|--------|
|     |           |      |        |
|     |           |      |        |
|     |           |      |        |
|     |           |      |        |
|     |           |      |        |

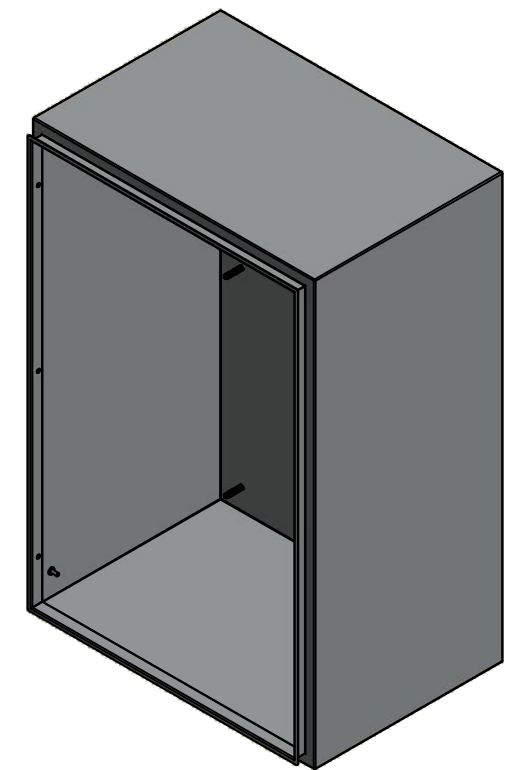

Isometric View

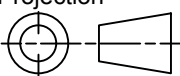

|  |   |
|--|---|
|  Tél: (450) 979-4373<br>Fax: (450) 979-4626<br><a href="http://www.exmweb.com">www.exmweb.com</a> | Flatness<br>Aplatissement<br>Max 3.0mm  |
|  | Projection<br> |
| Customer Client  | Date  |
| Drawn By<br>Dessiné Par BoxCad: BoxCad   | Date 07-Jul-22  |
| Material<br>Matière 16 Ga Stainless Steel 316 (1.4mm)  |   |
| Color<br>Couleur Asa-61 Grey   | Finish<br>Fini Smooth   |
| Description<br>5412ESSP 36" x 24" x 16" Body   | Detail Rev.   |
| Part Number<br>Numéro Pièce <b>5412ESSP3624166B</b>  | Rev. <b>0</b>   |

SEE BILL OF MATERIAL ON LAST PAGE

3  
9

This drawing is confidential and must not be reproduced or used without the consent of EXM

Ce dessin est confidentiel et ne doit pas être reproduit ou utilisé sans le consentement de EXM

| <b>STANDARD FEATURES ARE NOT LISTED IN THIS HOLE TABLE</b> |        |       |                             |
|--|--------|-------|-----------------------------|
| <b>HOLE TABLE - LEFT VIEW (CUSTOM FEATURE ONLY)</b>        |        |       |                             |
| CUT-OUT  | XDIM   | YDIM  | DESCRIPTION                 |
| 1  | 14.500 | 2.000 | GND STUD M6 x 16mm (Inside) |

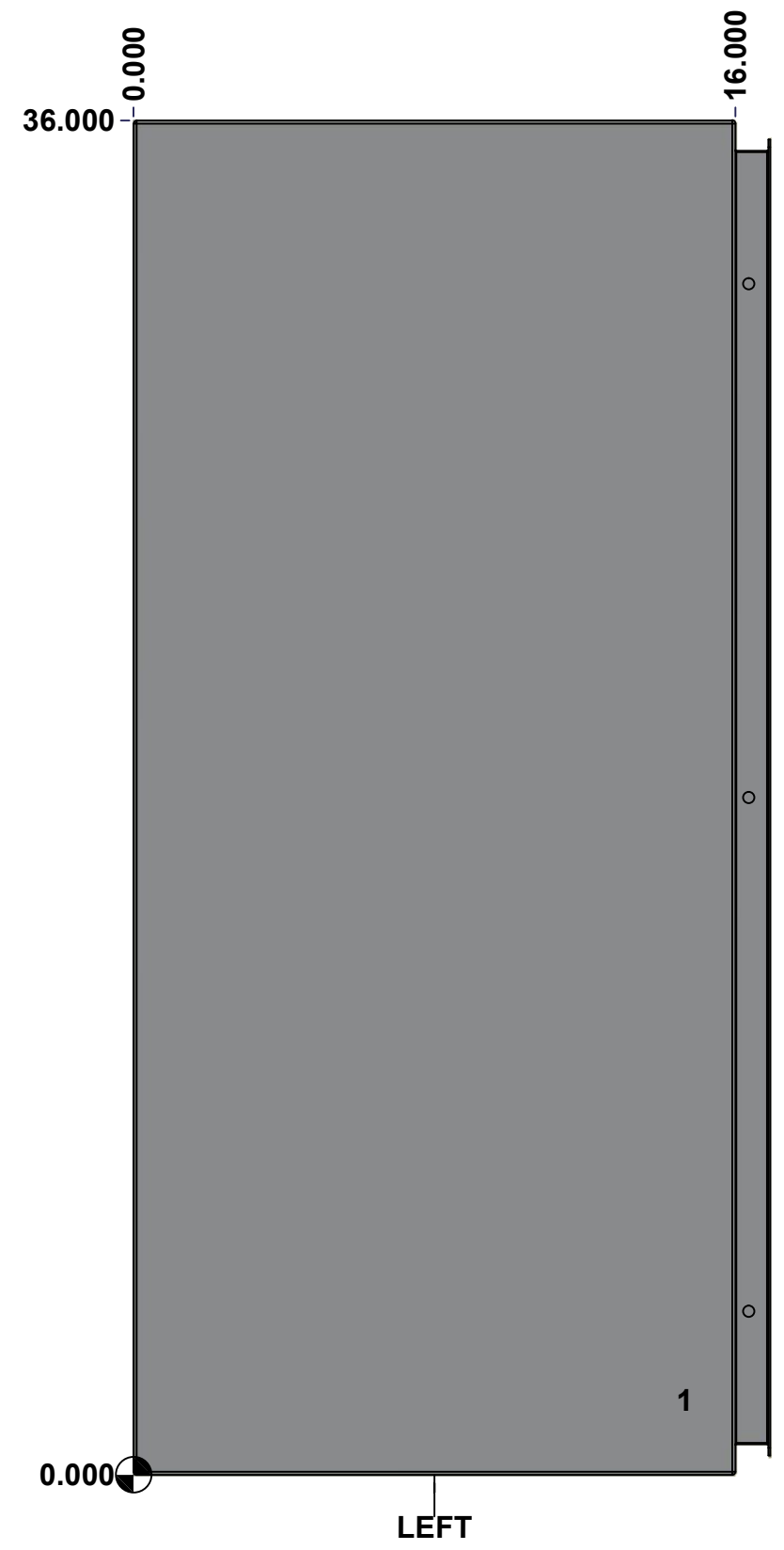

|  |                               |          |   |
|--|-------------------------------|----------|---|
|  | Description                   | Status   |   |
|  | 5412ESSP 36" x 24" x 16" Body | (NULL)   |   |
|  | Part Number<br>Numéro Pièce   | Rev.     | 4 |
|  | <b>5412ESSP3624166B</b>       | <b>0</b> | 9 |

This drawing is confidential and must not be reproduced or used without the consent of EXM

Ce dessin est confidentiel et ne doit pas être reproduit ou utilisé sans le consentement de EXM

**STANDARD FEATURES ARE NOT LISTED IN THIS HOLE TABLE**

**HOLE TABLE - BACK VIEW (CUSTOM FEATURE ONLY)**

| CUT-OUT | XDIM   | YDIM   | DESCRIPTION                |
|---------|--------|--------|----------------------------|
| 1       | 1.875  | 1.875  | IP STUD M8 x 35mm (Inside) |
| 2       | 1.875  | 34.125 | IP STUD M8 x 35mm (Inside) |
| 3       | 22.125 | 34.125 | IP STUD M8 x 35mm (Inside) |
| 4       | 22.125 | 1.875  | IP STUD M8 x 35mm (Inside) |
| 5       | 1.875  | 18.000 | IP STUD M8 x 35mm (Inside) |
| 6       | 22.125 | 18.000 | IP STUD M8 x 35mm (Inside) |
| -----   |        |        |                            |
| 7       | 23.250 | 0.750  | RND Ø0.390                 |
| 8       | 23.250 | 35.250 | RND Ø0.390                 |
| 9       | 0.750  | 35.250 | RND Ø0.390                 |
| 10      | 0.750  | 0.750  | RND Ø0.390                 |

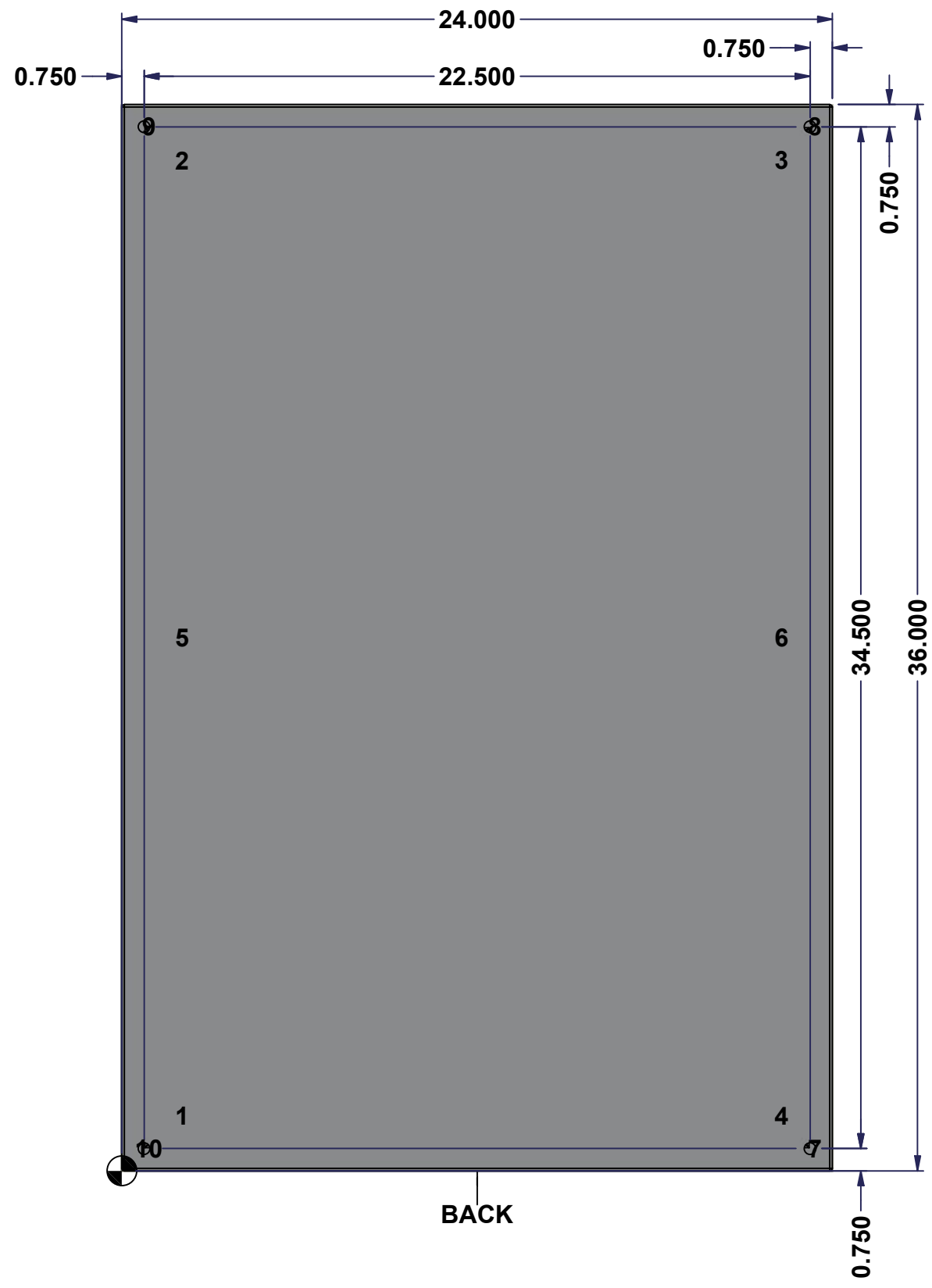

BACK

|  |                               |          |   |
|--|-------------------------------|----------|---|
|  | Description                   | Status   |   |
|  | 5412ESSP 36" x 24" x 16" Body | (NULL)   |   |
|  | Part Number                   | Rev.     | 5 |
|  | Numéro Pièce                  | <b>0</b> | 9 |
|  | <b>5412ESSP3624166B</b>       |          |   |

This drawing is confidential and must not be reproduced or used without the consent of EXM

Ce dessin est confidentiel et ne doit pas être reproduit ou utilisé sans le consentement de EXM

| No. | Revisions | Date | By/Par |
|-----|-----------|------|--------|
|     |           |      |        |
|     |           |      |        |
|     |           |      |        |
|     |           |      |        |
|     |           |      |        |

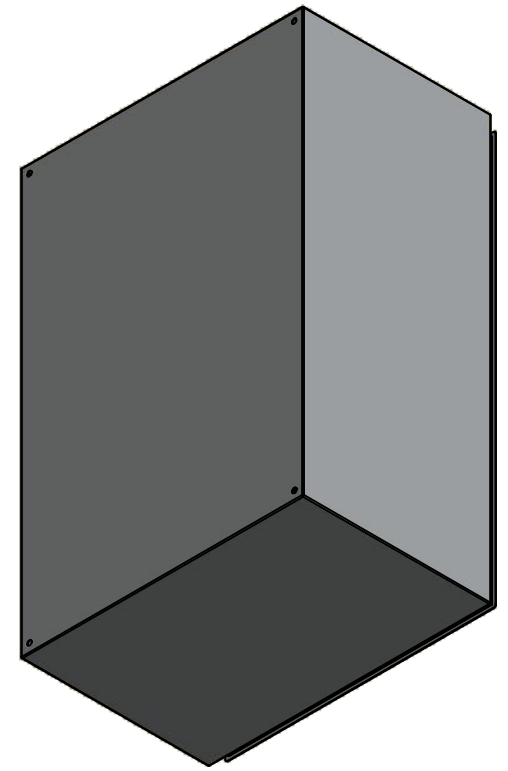

Isometric View



Tél: (450) 979-4373  
 Fax: (450) 979-4626  
[www.exmweb.com](http://www.exmweb.com)

Flatness  
Aplatissement  
Max 3.0mm  
Projection

|   |                       |
|---|-----------------------|
| Customer Client                                       | Date                  |
| Drawn By<br>Dessiné Par BoxCad: BoxCad                | Date 07-Jul-22        |
| Material<br>Matière 16 Ga Stainless Steel 316 (1.4mm) |                       |
| Color<br>Couleur Asa-61 Grey                          | Finish<br>Fini Smooth |

| Qty        | Part Number        | Rev | Description                           |
|------------|--------------------|-----|---------------------------------------|
| 1          | STK-Q-16085        | 0   | Ground Stud M6 x 16mm Stainless Steel |
| 1          | STK-P-02400S       | 0   | Powder Paint (Asa-61 Grey / Smooth)   |
| 6          | STK-Q-16020        | 1   | Stud M8 x 35mm Stainless Steel        |
| 1          | 5412ESSP3624166B-P | 0   | 5412ESSP 36" x 24" x 16" Body Part    |
| Parts List |                    |     |                                       |

|  |                      |
|--|----------------------|
| Description<br>5412ESSP 36" x 24" x 16" Body           | Detail Rev.          |
| Part Number<br>Numéro Pièce<br><b>5412ESSP3624166B</b> | Rev. 6<br><b>0</b> 9 |

This drawing is confidential and must not be reproduced or used without the consent of EXM

Ce dessin est confidentiel et ne doit pas être reproduit ou utilisé sans le consentement de EXM



TOP

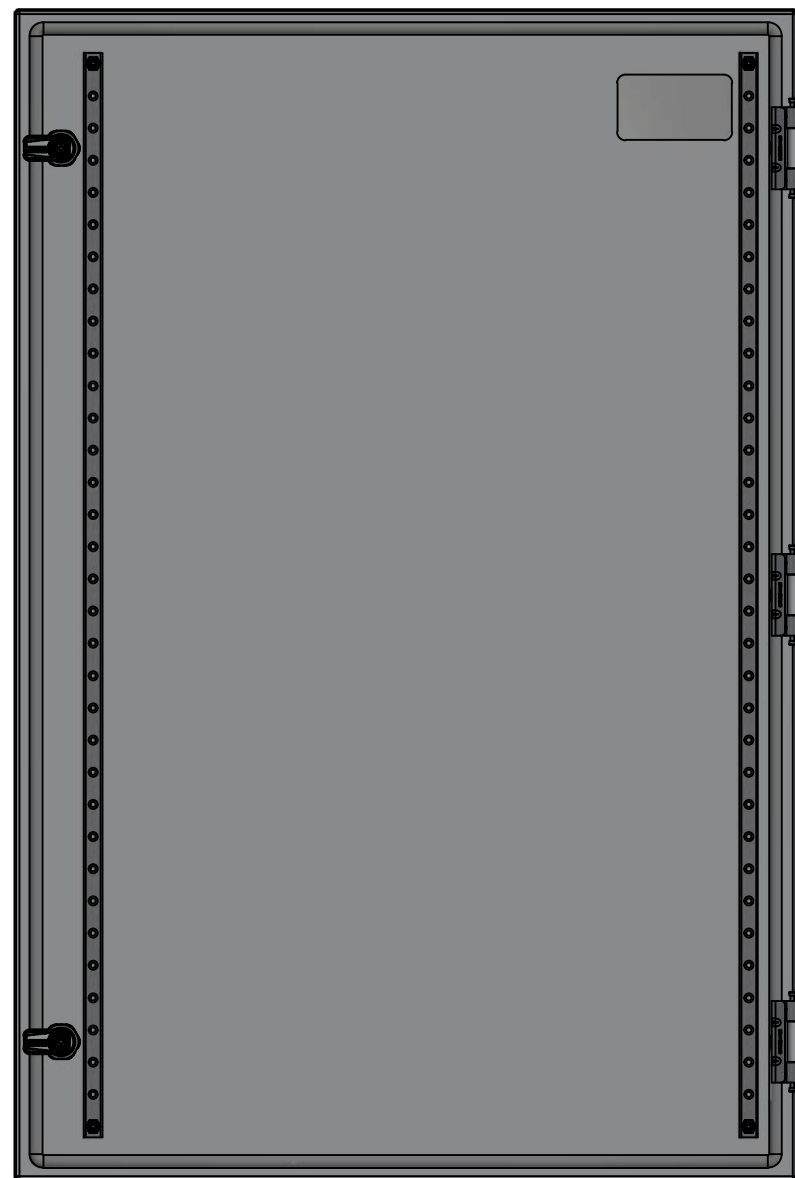

BACK



BOTTOM

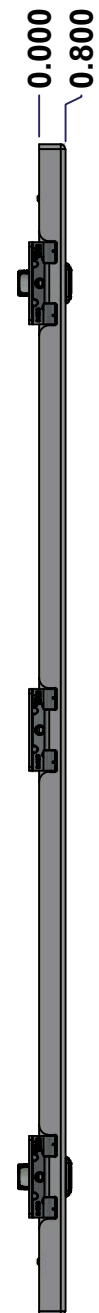

LEFT

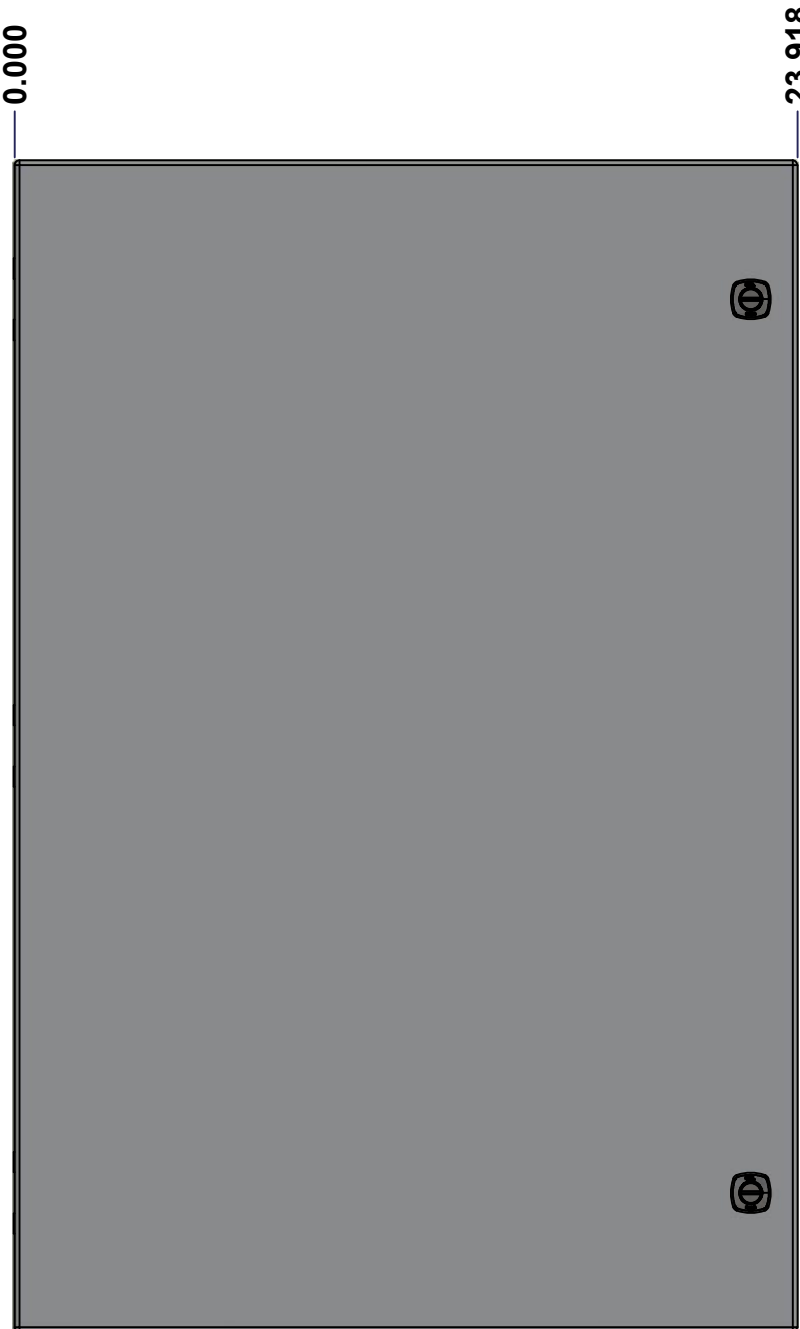

FRONT

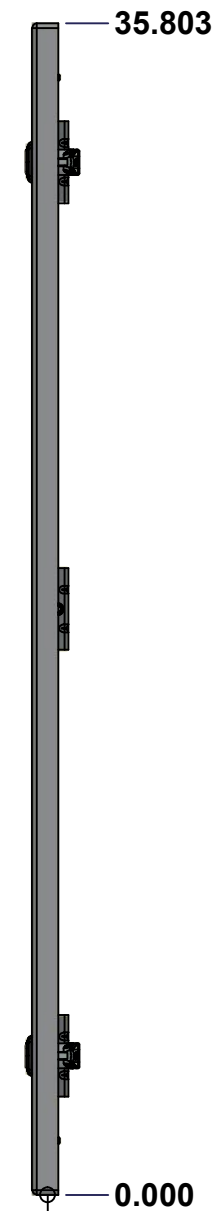

RIGHT

| No. | Revisions | Date | By/Par |
|-----|-----------|------|--------|
|     |           |      |        |
|     |           |      |        |
|     |           |      |        |
|     |           |      |        |
|     |           |      |        |

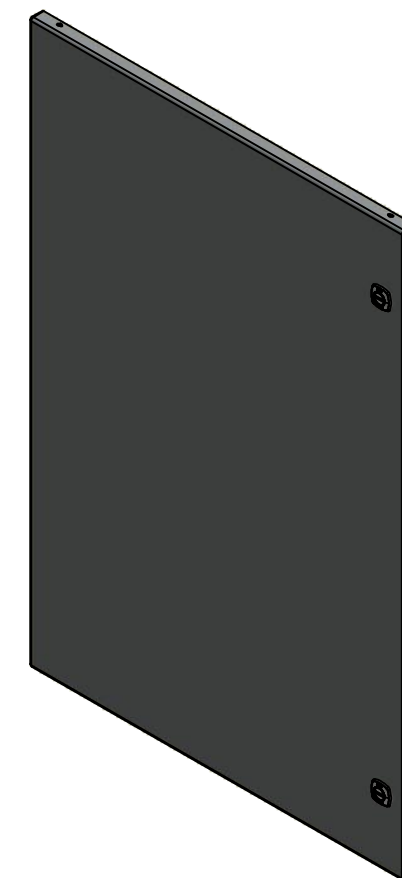

Isometric View



Tél: (450) 979-4373  
 Fax: (450) 979-4626  
[www.exmweb.com](http://www.exmweb.com)

Flatness  
Aplatissement

Max 3.0mm

Projection



|   |                       |
|---|-----------------------|
| Customer Client                                       | Date                  |
| Drawn By<br>Dessiné Par BoxCad: BoxCad                | Date 07-Jul-22        |
| Material<br>Matière 16 Ga Stainless Steel 316 (1.4mm) |                       |
| Color<br>Couleur Asa-61 Grey                          | Finish<br>Fini Smooth |
| Description<br>5412ESSP 36" x 24" Cover               | Detail Rev.           |
| Part Number<br>Numéro Pièce <b>5412ESSP3624166C</b>   | Rev. 7<br><b>0</b>    |

SEE BILL OF MATERIAL ON LAST PAGE

This drawing is confidential and must not be reproduced or used without the consent of EXM

Ce dessin est confidentiel et ne doit pas être reproduit ou utilisé sans le consentement de EXM

**STANDARD FEATURES ARE NOT LISTED IN THIS HOLE TABLE**

**HOLE TABLE - FRONT VIEW (CUSTOM FEATURE ONLY)**

| CUT-OUT | XDIM   | YDIM   | DESCRIPTION                |
|---------|--------|--------|----------------------------|
| 1       | 1.486  | 1.661  | STUD M6 x 18mm (Inside)    |
| 2       | 1.486  | 34.142 | STUD M6 x 18mm (Inside)    |
| 3       | 21.517 | 34.142 | STUD M6 x 18mm (Inside)    |
| 4       | 21.517 | 1.661  | STUD M6 x 18mm (Inside)    |
| -----   |        |        |                            |
| 5       | 3.750  | 32.803 | LABEL_EXM (Inside)         |
| 6       | 22.494 | 31.553 | LOCK 880 SCQ4-SLSS6 @ 0.0° |
| 7       | 22.494 | 4.250  | LOCK 880 SCQ4-SLSS6 @ 0.0° |

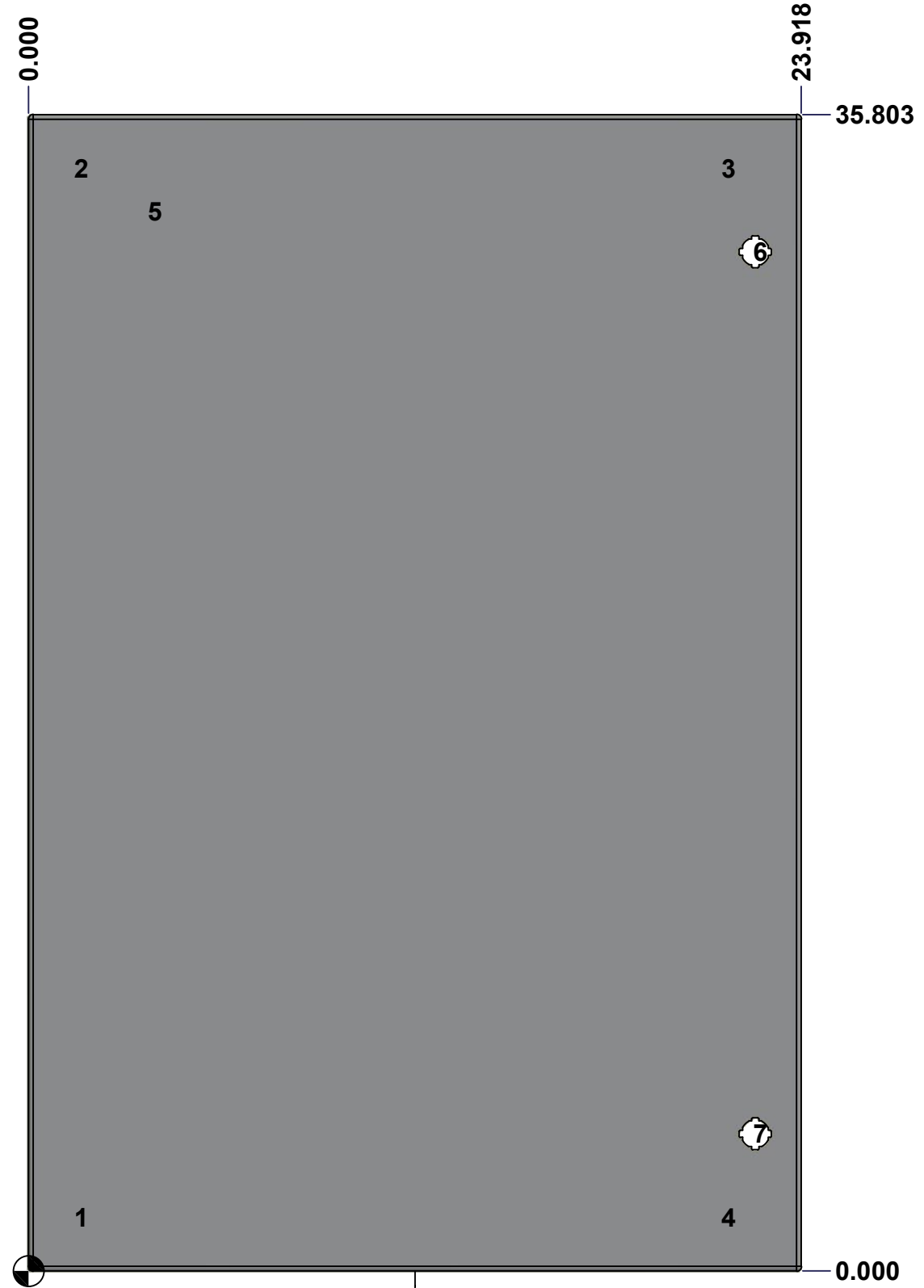

FRONT

|  |                             |                  |
|--|-----------------------------|------------------|
|  | Description                 | Status           |
|  | 5412ESSP 36" x 24" Cover    | (NULL)           |
|  | Part Number<br>Numéro Pièce | Rev.             |
|  | <b>5412ESSP3624166C</b>     | <b>0</b> / 8 / 9 |



This drawing is confidential and must not be reproduced or used without the consent of EXM

Ce dessin est confidentiel et ne doit pas être reproduit ou utilisé sans le consentement de EXM

| No. | Revisions | Date | By/Par |
|-----|-----------|------|--------|
|     |           |      |        |
|     |           |      |        |
|     |           |      |        |
|     |           |      |        |
|     |           |      |        |



Isometric View

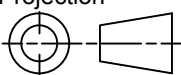

|  |                                   |   |
|--|-----------------------------------|---|
|  Tél: (450) 979-4373<br>Fax: (450) 979-4626<br><a href="http://www.exmweb.com">www.exmweb.com</a> | Flatness<br>Aplatissement         | Max 3.0mm   |
|  | Projection                        |  |
| Customer<br>Client   | Date                              |   |
| Drawn By<br>Dessiné Par  | BoxCad: BoxCad                    | Date 07-Jul-22  |
| Material<br>Matière  | 16 Ga Stainless Steel 316 (1.4mm) |   |
| Color<br>Couleur   | Asa-61 Grey                       | Finish<br>Fini Smooth   |
| Description  | 5412ESSP 36" x 24" Cover          |   |
| Part Number<br>Numéro Pièce  | 5412ESSP3624166C                  | Rev. 9  |
|  |                                   | 0   |

| Qty        | Part Name          | Rev | Description                            |
|------------|--------------------|-----|--|
| 1          | STK-S-00100        | 0   | 3.5" x 2" Silver Milar Flexcon Sticker |
| 1          | STK-P-02400S       | 0   | Powder Paint (Asa-61 Grey / Smooth)    |
| 2          | STK-Q-46020-36     | 5   | 5412 ES Vertical Door Stiffener 36"    |
| 4          | STK-Q-16070        | 1   | Stud M6 x 18mm Stainless steel         |
| 1          | 5412ESSP3624166G   | 0   | 5412ESSP 36" x 24" Cover Gasket Part   |
| 1          | 5412ESSP3624166C-P | 0   | 5412ESSP 36" x 24" Cover Part          |
| 3          | STK-A-33016        | 0   | 5412 ESS Bended Hinge (Body Part)      |
| 2          | 880 SCQ4-SLSS6     | 7   | 5412 ESS 1/4 Turn Lock                 |
| 4          | STK-Q-07220        | 1   | M6 Nylon Insert Lock Nut               |
| Parts List |                    |     |  |

This drawing is confidential and must not be reproduced or used without the consent of EXM

Ce dessin est confidentiel et ne doit pas être reproduit ou utilisé sans le consentement de EXM

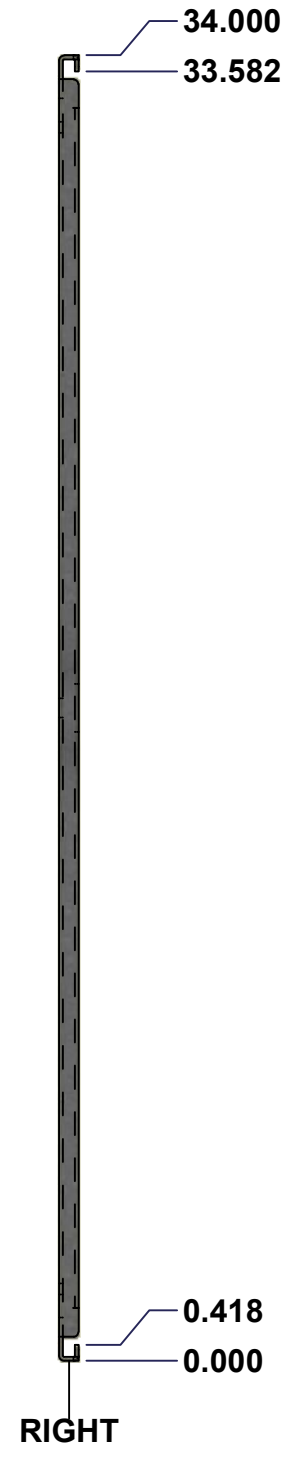
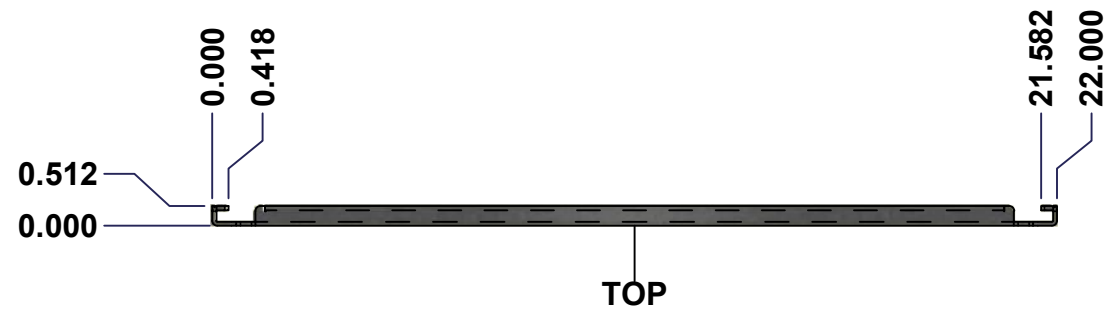

| No. | Revisions | Date | By/Par |
|-----|-----------|------|--------|
|     |           |      |        |
|     |           |      |        |
|     |           |      |        |
|     |           |      |        |
|     |           |      |        |

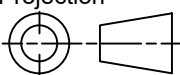

|  |               |   |
|--|---------------|---|
|  Tél: (450) 979-4373<br>Fax: (450) 979-4626<br>www.exmweb.com |               | Flatness<br>Aplatissement<br>Max 3.0mm<br>Projection<br> |
| Customer Client  | Date          |   |
| Drawn By<br>Dessiné Par  | BoxCad        | Date 1/23/2007  |
| Material<br>Matière  | See Part List |   |
| Color<br>Couleur   | See Part List | Finish<br>Fini See Part List  |
| Description  |               | Detail Rev.   |
| 881 SP - Inner Panel   |               |   |
| Part Number<br>Numéro Pièce  | 881 SP3624G   | Rev. 1<br>0 2   |

| Qty | Part Number   | Rev | Description               | Material         | Color     | Finish     |
|-----|---------------|-----|---------------------------|------------------|-----------|------------|
| 1   | 881 SP3624G-P | 0   | 881 SP - Inner Panel Part | 12 Ga Galvanized | Unpainted | Galvanized |

Parts List

This drawing is confidential and must not be reproduced or used without the consent of EXM

Ce dessin est confidentiel et ne doit pas être reproduit ou utilisé sans le consentement de EXM

| Table 1 |        |        | FRONT VIEW                 |
|---------|--------|--------|----------------------------|
| CUT-OUT | XDIM   | YDIM   | DESCRIPTION                |
| 1       | 0.875  | 1.875  | GROUND HOLE (RND Ø0.290)   |
| 2       | 21.125 | 1.875  | GROUND HOLE (RND Ø0.290)   |
| 3       | 0.875  | 32.125 | GROUND HOLE (RND Ø0.290)   |
| 4       | 21.125 | 32.125 | GROUND HOLE (RND Ø0.290)   |
| 5       | 0.875  | 17.000 | MTG STUD HOLE (RND Ø0.500) |
| 6       | 21.125 | 17.000 | MTG STUD HOLE (RND Ø0.500) |

All knockouts are actual size / Les disques défonçables sont grandeur réel

| No. | Revisions | Date | By/Par |
|-----|-----------|------|--------|
|     |           |      |        |
|     |           |      |        |
|     |           |      |        |
|     |           |      |        |
|     |           |      |        |
|     |           |      |        |



FRONT



Isometric View



|                            |  |               |               |
|----------------------------|--|---------------|---------------|
|                            | Tél: (450) 979-4373<br>Fax: (450) 979-4626<br>www.exmweb.com | Flatness      |               |
|                            |  | Aplatissement |               |
|                            |  | Max 3.0mm     |               |
|                            |  | Projection    |               |
| Customer Client            |  | Date          |               |
| Drawn By / Dessiné Par     | BoxCad   | Date          | 1/23/2007     |
| Material / Matière         | See Part List  |               |               |
| Color / Couleur            | See Part List  | Finish / Fini | See Part List |
| Description                | 881 SP - Inner Panel   |               | Detail Rev.   |
| Part Number / Numéro Pièce | 881 SP3624G  |               | Rev. 2        |
|                            |  |               | 0             |