

This drawing is confidential and must not be reproduced or used without the consent of EXM

Ce dessin est confidentiel et ne doit pas être reproduit ou utilisé sans le consentement de EXM

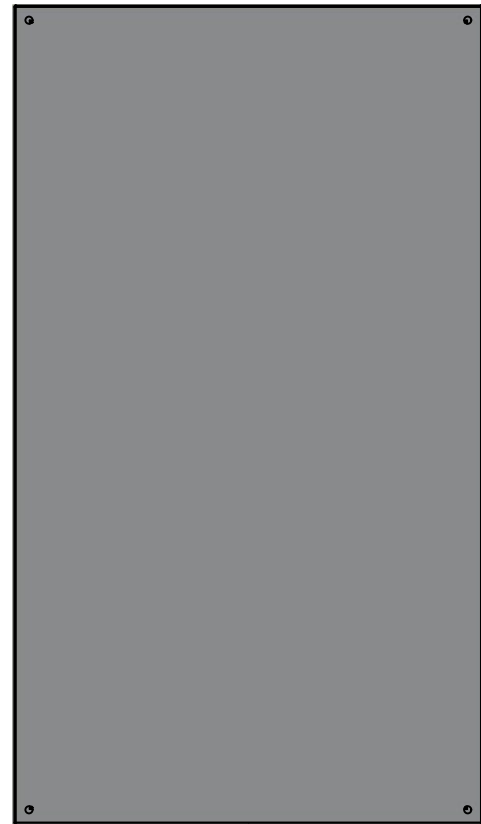

TOP



BACK



BOTTOM

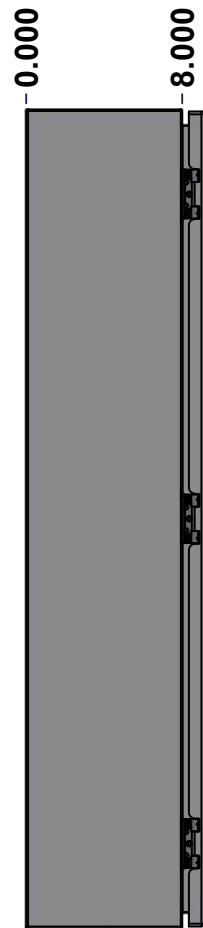

LEFT

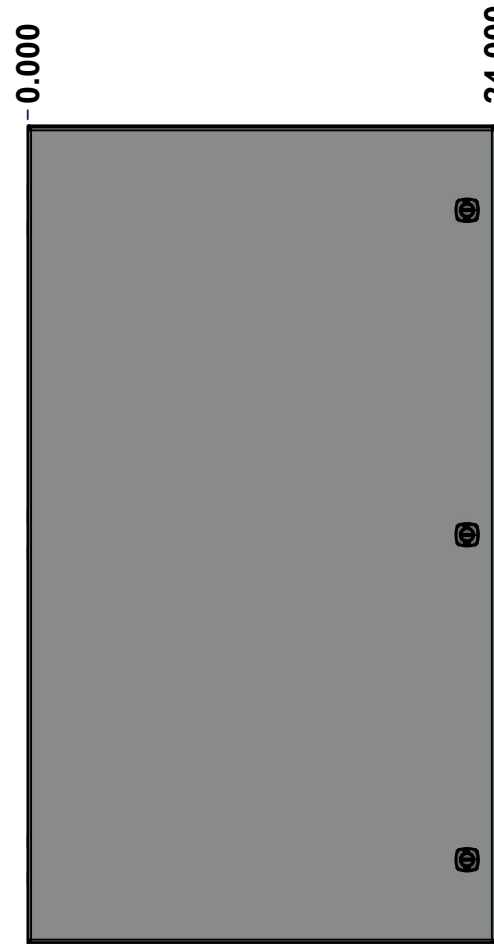

FRONT

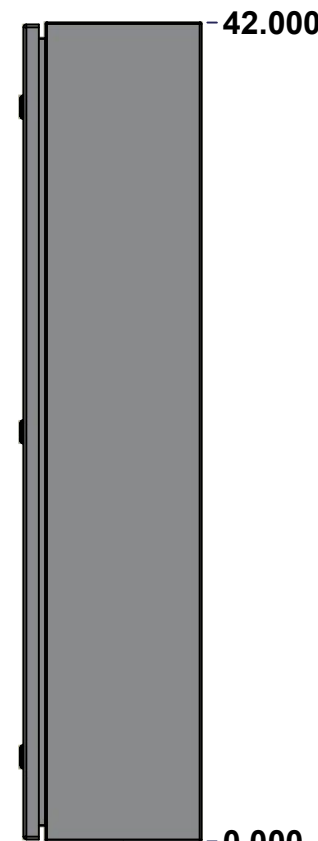

RIGHT

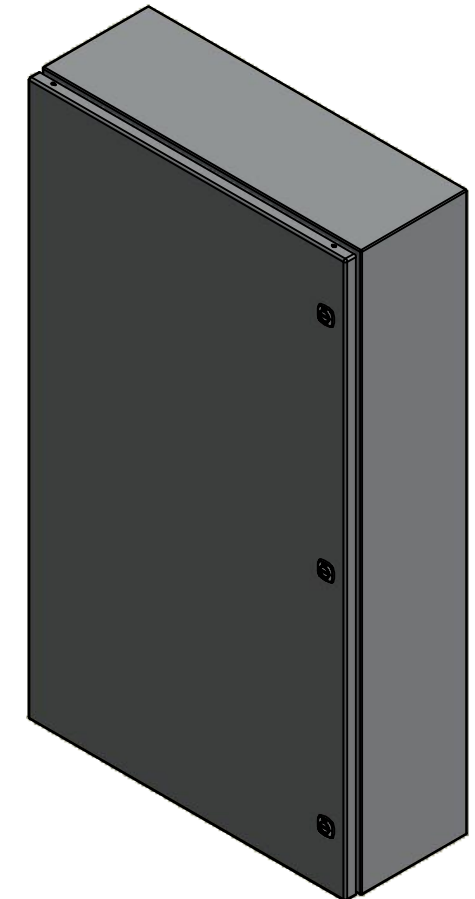

Isometric View

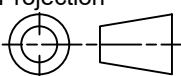

No.	Revisions	Date	By/Par

 Tél: (450) 979-4373 Fax: (450) 979-4626 <a href="http://www.exmweb.com">www.exmweb.com</a>		Flatness Aplatissement Max 3.0mm Projection 
Customer Client	Date	
Drawn By Dessiné Par	BoxCad: BoxCad	Date 7/8/2022
Material Matière	16 Ga Stainless Steel 316 (1.4mm)	
Color Couleur	Asa-61 Grey	Finish Fini Smooth
Description 5412ESSP 42" x 24" x 8" Assembly		Detail Rev.
Part Number Numéro Pièce	5412ESSP4224086NOIP	Rev. 1 0

SEE BILL OF MATERIAL ON LAST PAGE

This drawing is confidential and must not be reproduced or used without the consent of EXM

Ce dessin est confidentiel et ne doit pas être reproduit ou utilisé sans le consentement de EXM

NOTE	
ITEM	DESCRIPTION
1	NEMA 4X Enclosure
2	C/W Standard ground studs on box and cover
3	C/W Standard door stiffener
4	W/O Inner panel
5	C/W Standard inner panel mounting studs
6	C/W Special locks sold separately (Installed)

No.	Revisions	Date	By/Par

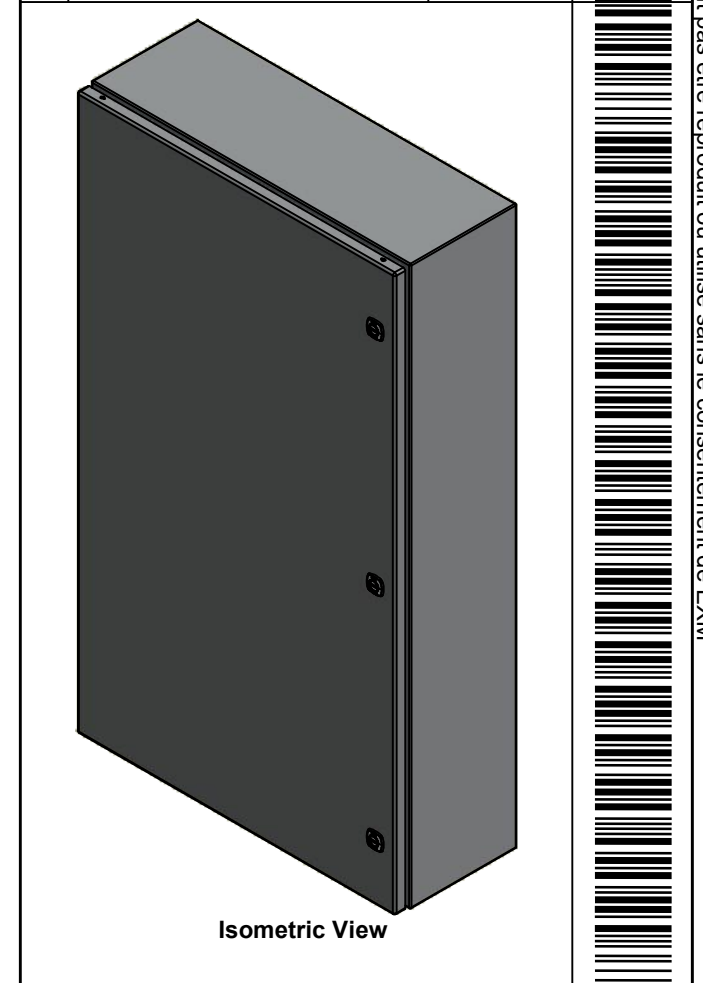

PACKING		
ITEM	QTY	DESCRIPTION
Cardboard sleeve	2	Top and Bottom
Cardboard strip	2	Between back of enclosure and inner panel
Plastic bag	1	To protect cover surface and inside gasket
Cardboard corner	4	To reinforced for the plastic strap tightening
Plastic strap - Black	2	To Squeeze the 2 cardboard sleeve together
Packaging label	3	White label with PN
Plastic strap- Green	2	To secure the enclosure to the wood pallet
Wood Pallet	1	2" deeper and 3" larger than enclosure size

1	880 PP	6	Self Adhesive Print Pocket
1	STK-K-01800	5	5412 ES Accessory Kit
1	5412ESSP4224086NOIPC	0	5412ESSP 42" x 24" Cover
1	5412ESSP4224086NOIPB	0	5412ESSP 42" x 24" x 8" Body
3	STK-Q-04051-07	8	M6 x 7mm Stainless Steel Hexagon Socket Head Machine Screw with Nyseal
Qty	Part Number	Rev	Description
Parts List			

		Tél: (450) 979-4373 Fax: (450) 979-4626 <a href="http://www.exmweb.com">www.exmweb.com</a>		Flatness Aplatissement Max 3.0mm Projection 
Customer Client		Date		
Drawn By / Dessiné Par: BoxCad: BoxCad		Date: 7/8/2022		
Material / Matière: 16 Ga Stainless Steel 316 (1.4mm)		Color / Couleur: Asa-61 Grey		
Description: 5412ESSP 42" x 24" x 8" Assembly		Finish / Fini: Smooth		
Part Number / Numéro Pièce: 5412ESSP4224086NOIP		Rev.:	2	
		0	9	

This drawing is confidential and must not be reproduced or used without the consent of EXM

Ce dessin est confidentiel et ne doit pas être reproduit ou utilisé sans le consentement de EXM



TOP

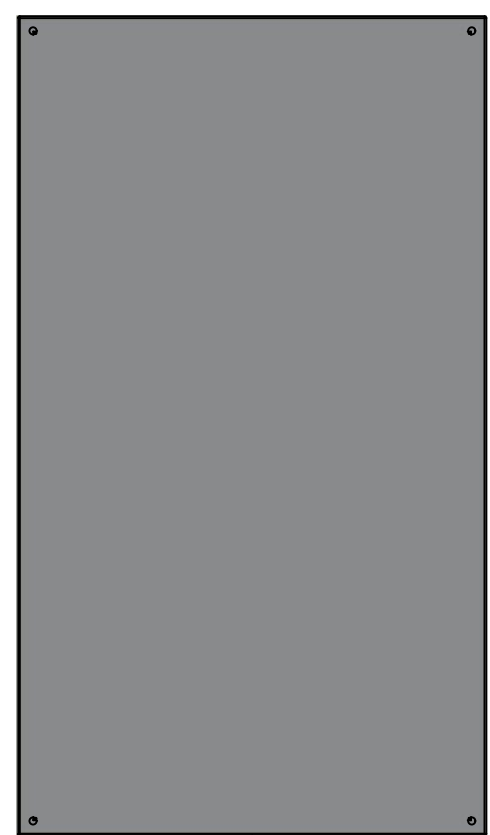

BACK

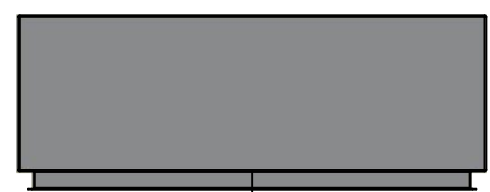

BOTTOM

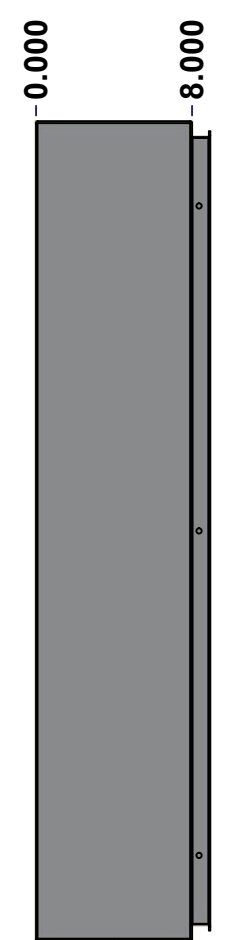

LEFT

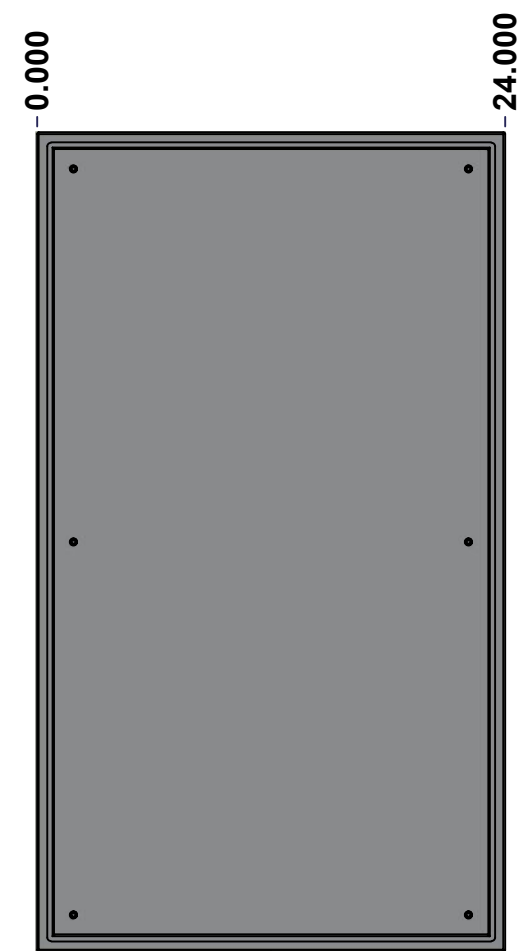

FRONT

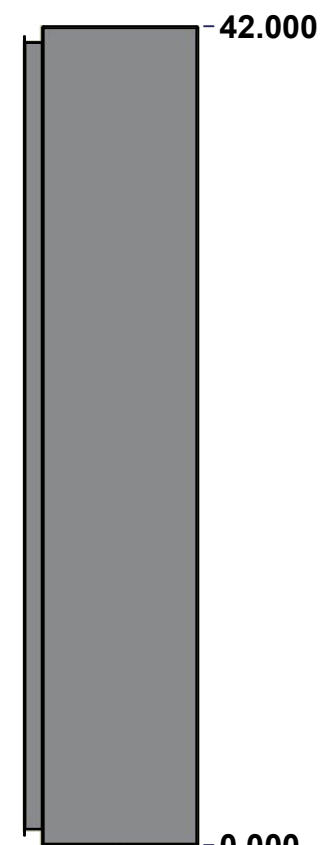

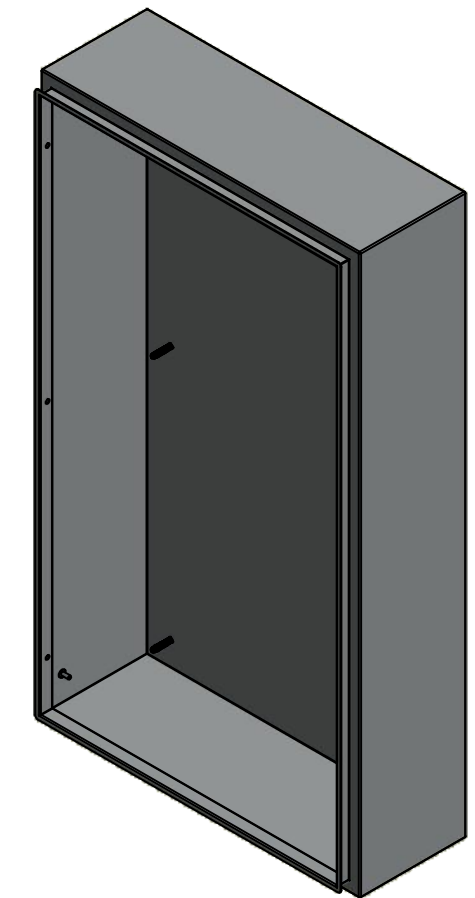

RIGHT

No.	Revisions	Date	By/Par

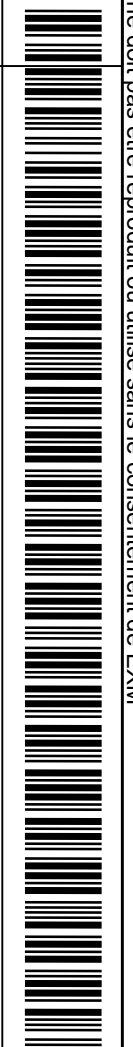

Isometric View

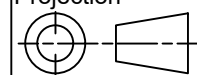

 Tél: (450) 979-4373 Fax: (450) 979-4626 <a href="http://www.exmweb.com">www.exmweb.com</a>		Flatness Aplatissement Max 3.0mm Projection 
Customer Client	Date	
Drawn By Dessiné Par	BoxCad: BoxCad	Date 7/8/2022
Material Matière	16 Ga Stainless Steel 316 (1.4mm)	
Color Couleur	Asa-61 Grey	Finish Fini Smooth
Description	Detail Rev.	
5412ESSP 42" x 24" x 8" Body		
Part Number Numéro Pièce	Rev. 0	3 9

SEE BILL OF MATERIAL ON LAST PAGE

**5412ESSP4224086NOIPB**

This drawing is confidential and must not be reproduced or used without the consent of EXM

Ce dessin est confidentiel et ne doit pas être reproduit ou utilisé sans le consentement de EXM

<b>STANDARD FEATURES ARE NOT LISTED IN THIS HOLE TABLE</b>			
<b>HOLE TABLE - LEFT VIEW (CUSTOM FEATURE ONLY)</b>			
CUT-OUT	XDIM	YDIM	DESCRIPTION
1	6.500	2.000	GND STUD M6 x 16mm (Inside)

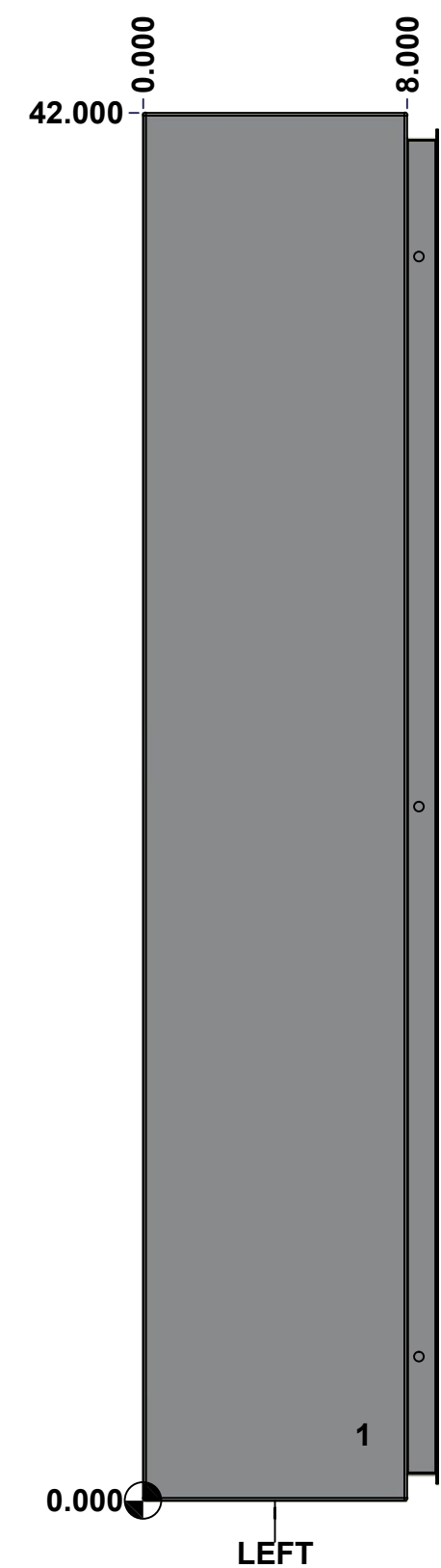

	Description	Status
	5412ESSP 42" x 24" x 8" Body	(NULL)
	Part Number Numéro Pièce	Rev.
	<b>5412ESSP4224086NOIPB</b>	<b>0</b>
		4
		9

This drawing is confidential and must not be reproduced or used without the consent of EXM

Ce dessin est confidentiel et ne doit pas être reproduit ou utilisé sans le consentement de EXM

**STANDARD FEATURES ARE NOT LISTED IN THIS HOLE TABLE**

**HOLE TABLE - BACK VIEW (CUSTOM FEATURE ONLY)**

CUT-OUT	XDIM	YDIM	DESCRIPTION
1	1.875	1.875	IP STUD M8 x 35mm (Inside)
2	1.875	40.125	IP STUD M8 x 35mm (Inside)
3	22.125	40.125	IP STUD M8 x 35mm (Inside)
4	22.125	1.875	IP STUD M8 x 35mm (Inside)
5	1.875	21.000	IP STUD M8 x 35mm (Inside)
6	22.125	21.000	IP STUD M8 x 35mm (Inside)
-----			
7	23.250	0.750	RND Ø0.390
8	0.750	41.250	RND Ø0.390
9	0.750	0.750	RND Ø0.390
10	23.250	41.250	RND Ø0.390

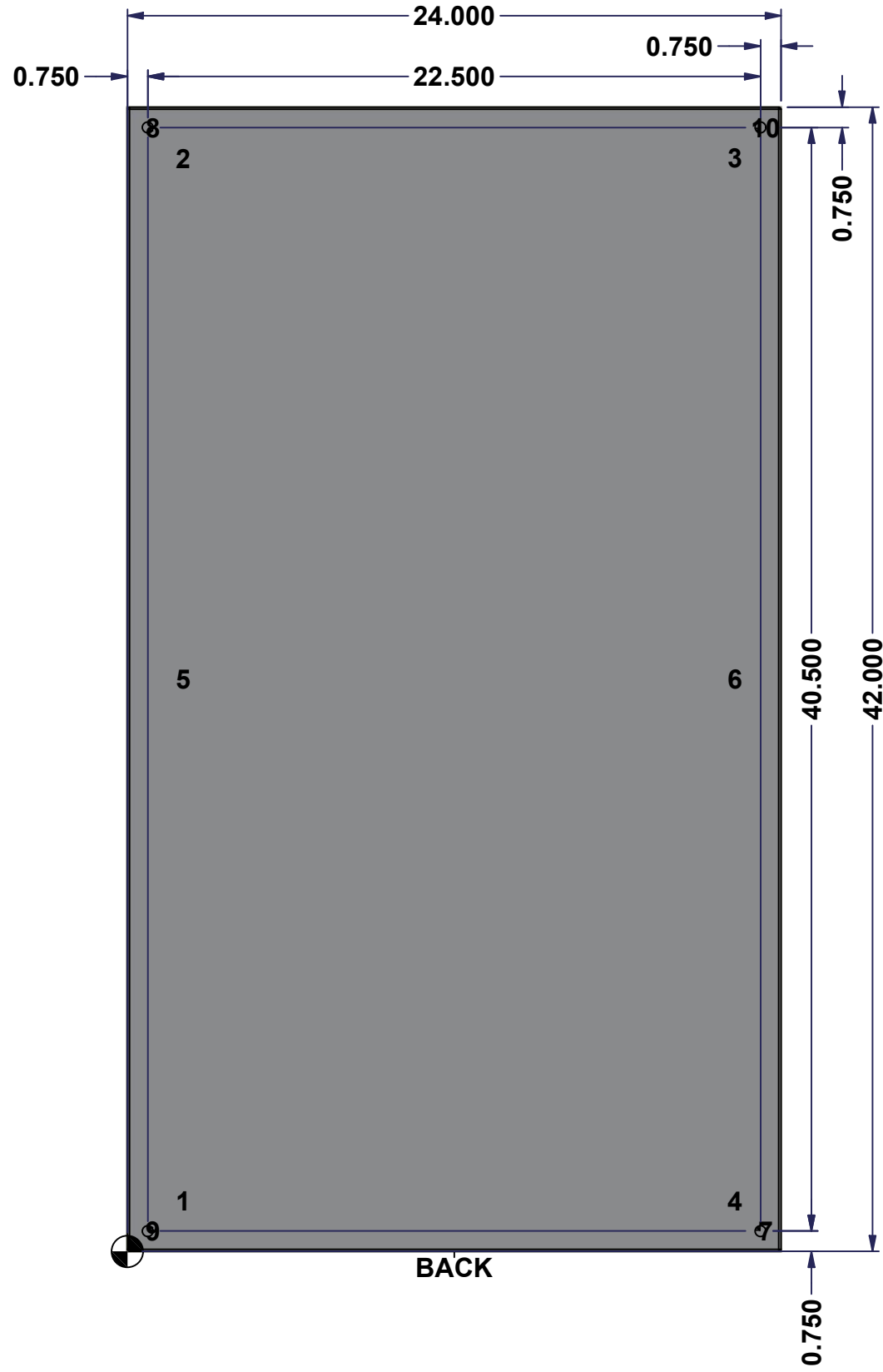

	Description	Status	
	5412ESSP 42" x 24" x 8" Body	(NULL)	
	Part Number Numéro Pièce	Rev.	5
	<b>5412ESSP4224086NOIPB</b>	<b>0</b>	9

This drawing is confidential and must not be reproduced or used without the consent of EXM

Ce dessin est confidentiel et ne doit pas être reproduit ou utilisé sans le consentement de EXM

No.	Revisions	Date	By/Par

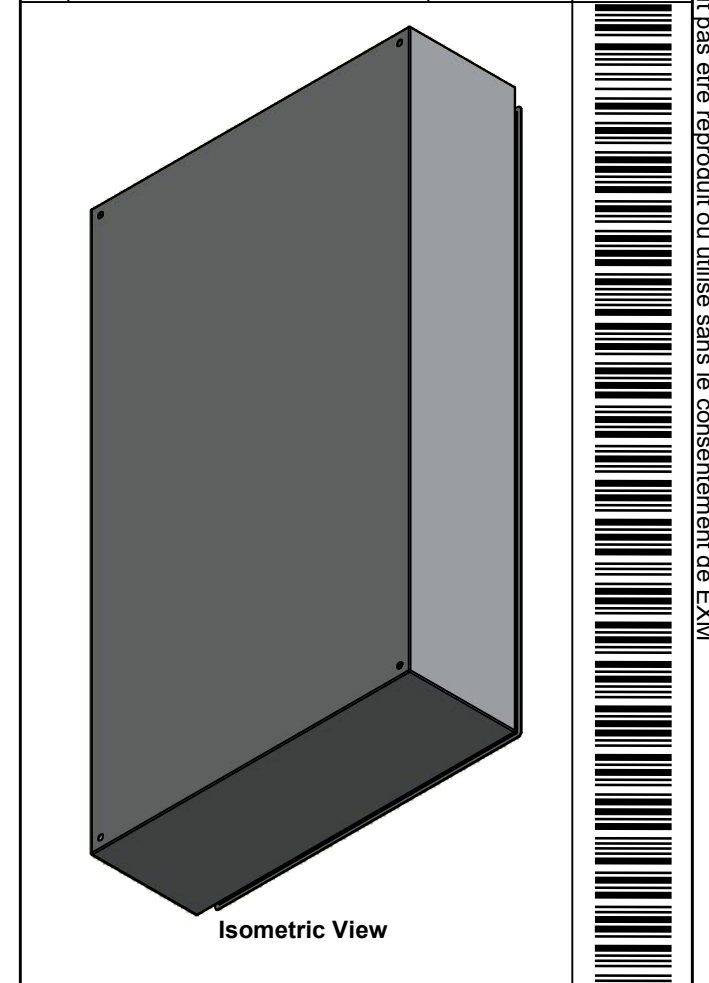

 Tél: (450) 979-4373  
 Fax: (450) 979-4626  
[www.exmweb.com](http://www.exmweb.com)

Flatness / Aplatissement: Max 3.0mm  
 Projection: 

Customer / Client	Date
Drawn By / Dessiné Par: BoxCad: BoxCad	Date: 7/8/2022
Material / Matière: 16 Ga Stainless Steel 316 (1.4mm)	
Color / Couleur: Asa-61 Grey	Finish / Fini: Smooth

1	STK-Q-16085	0	Ground Stud M6 x 16mm Stainless Steel
1	STK-P-02400S	0	Powder Paint (Asa-61 Grey / Smooth)
6	STK-Q-16020	1	Stud M8 x 35mm Stainless Steel
1	5412ESSP4224086NOIPB-P	0	5412ESSP 42" x 24" x 8" Body Part
Qty	Part Number	Rev	Description
Parts List			

Description: 5412ESSP 42" x 24" x 8" Body		Detail Rev.	
Part Number / Numéro Pièce: <b>5412ESSP4224086NOIPB</b>		Rev.:	6
		<b>0</b>	9

This drawing is confidential and must not be reproduced or used without the consent of EXM

Ce dessin est confidentiel et ne doit pas être reproduit ou utilisé sans le consentement de EXM



TOP

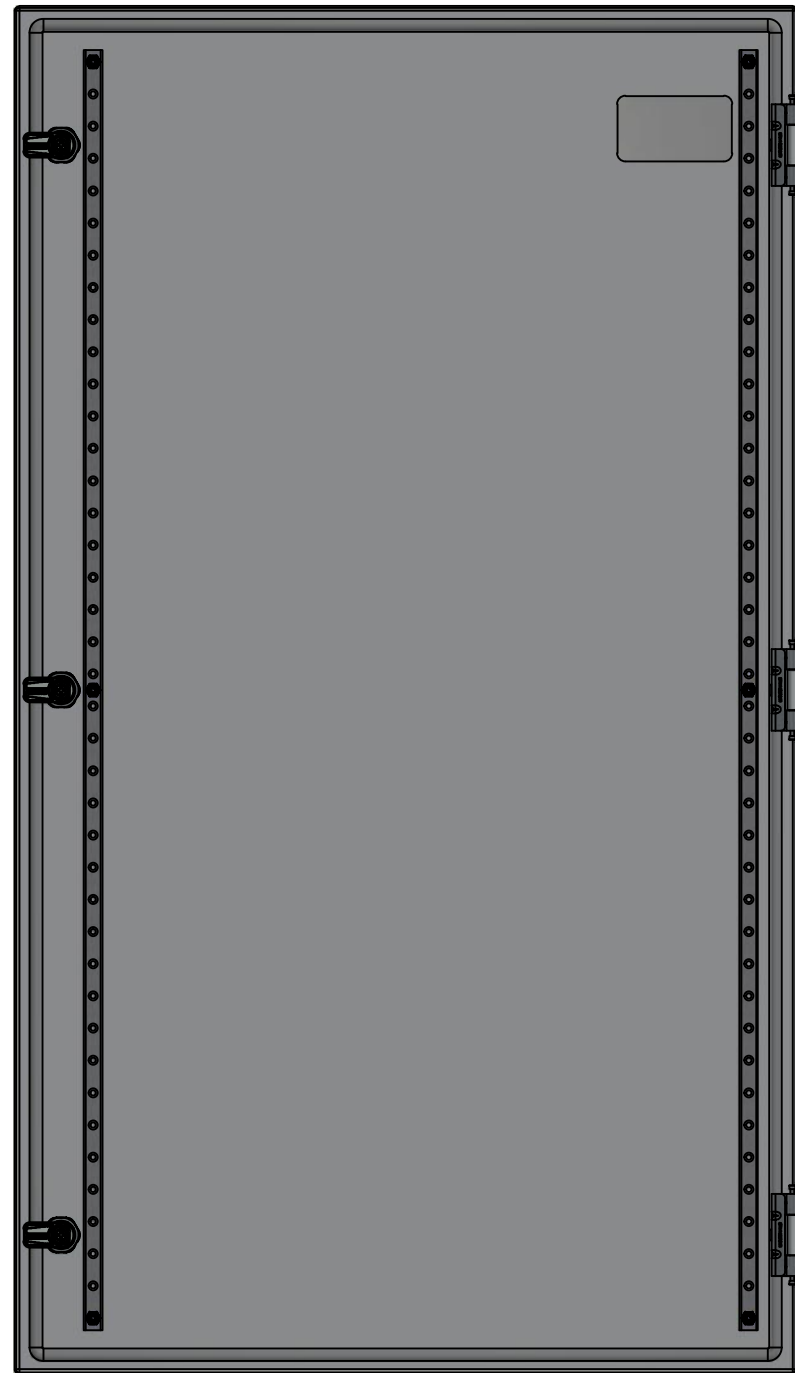

BACK



BOTTOM

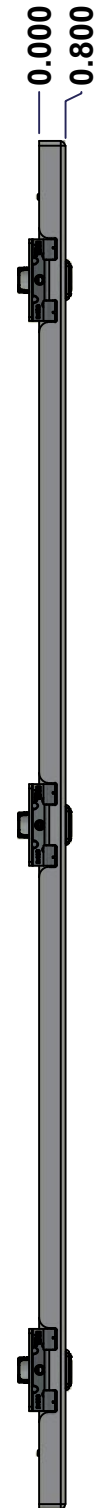

LEFT



FRONT

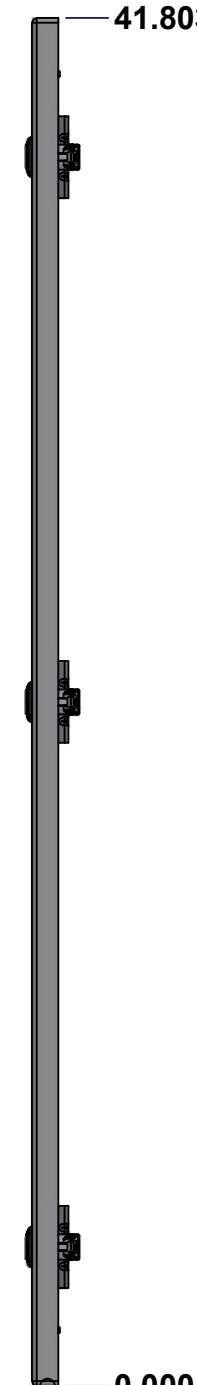

RIGHT

0.000  
0.800

0.000

23.918

41.803

0.000

No.	Revisions	Date	By/Par

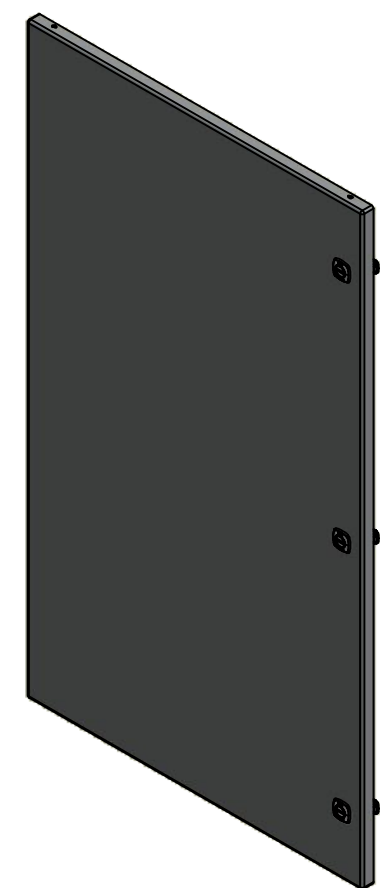

Isometric View



Tél: (450) 979-4373  
Fax: (450) 979-4626  
[www.exmweb.com](http://www.exmweb.com)

Flatness  
Aplatissement  
Max 3.0mm  
Projection

Customer Client	Date
Drawn By Dessiné Par BoxCad: BoxCad	Date 7/8/2022
Material Matière 16 Ga Stainless Steel 316 (1.4mm)	
Color Couleur Asa-61 Grey	Finish Fini Smooth
Description 5412ESSP 42" x 24" Cover	Detail Rev.
Part Number Numéro Pièce	Rev. 7
SEE BILL OF MATERIAL ON LAST PAGE <b>5412ESSP4224086NOIPC</b>	0 9

SEE BILL OF MATERIAL ON LAST PAGE **5412ESSP4224086NOIPC**

This drawing is confidential and must not be reproduced or used without the consent of EXM

Ce dessin est confidentiel et ne doit pas être reproduit ou utilisé sans le consentement de EXM

**STANDARD FEATURES ARE NOT LISTED IN THIS HOLE TABLE**

**HOLE TABLE - FRONT VIEW (CUSTOM FEATURE ONLY)**

CUT-OUT	XDIM	YDIM	DESCRIPTION
1	1.486	1.709	STUD M6 x 18mm (Inside)
2	1.486	40.094	STUD M6 x 18mm (Inside)
3	21.517	40.094	STUD M6 x 18mm (Inside)
4	21.517	1.709	STUD M6 x 18mm (Inside)
5	1.486	20.902	STUD M6 x 18mm (Inside)
6	21.517	20.902	STUD M6 x 18mm (Inside)
-----			
7	3.750	38.053	LABEL_EXM (Inside)
8	22.494	37.553	LOCK 880 SCQ4-SLSS6 @ 0.0°
9	22.494	20.902	LOCK 880 SCQ4-SLSS6 @ 0.0°
10	22.494	4.250	LOCK 880 SCQ4-SLSS6 @ 0.0°

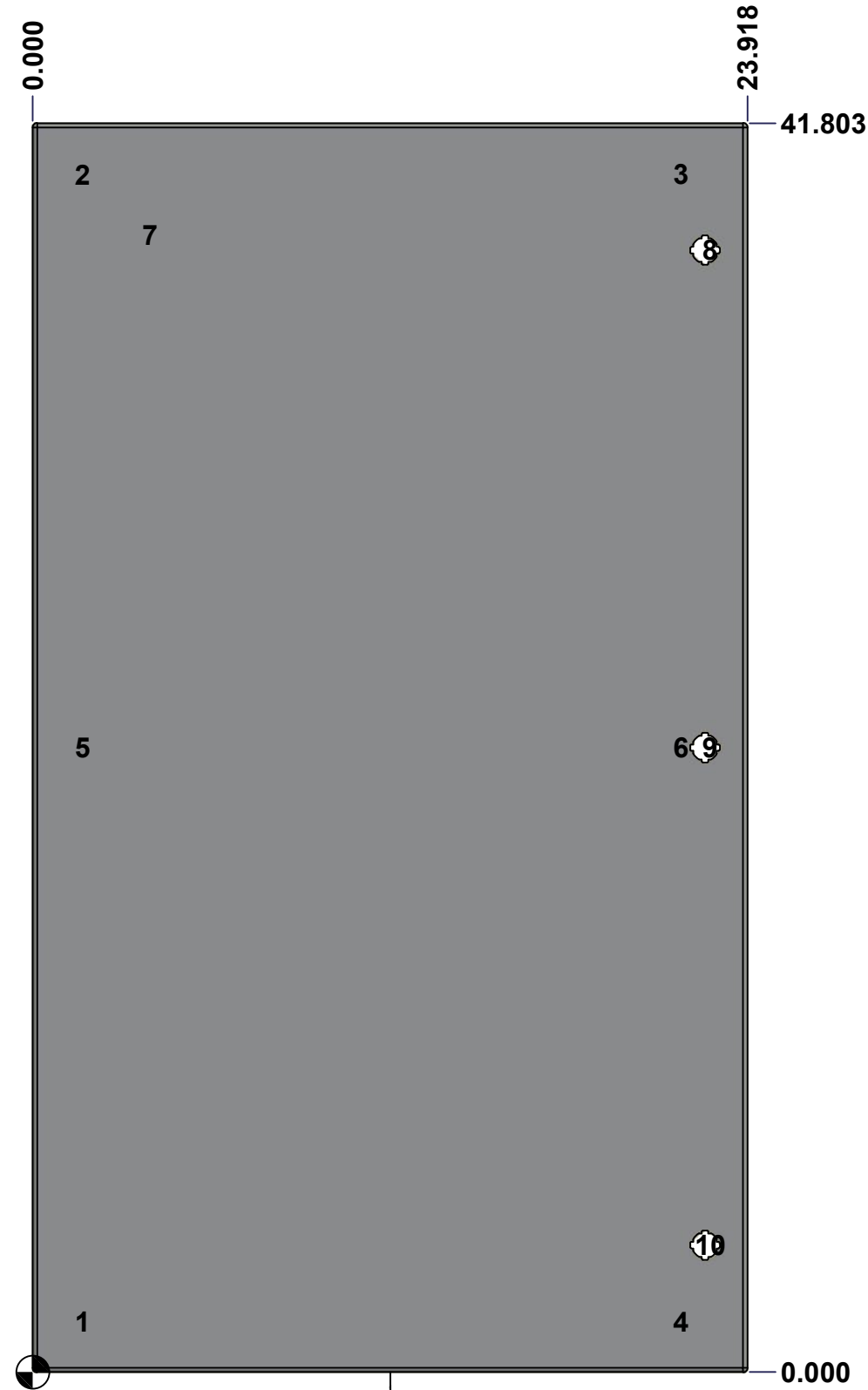

FRONT

	Description	Status
	5412ESSP 42" x 24" Cover	(NULL)
	Part Number Numéro Pièce	Rev.
	<b>5412ESSP4224086NOIPC</b>	<b>0</b>
		8
		9



