

This drawing is confidential and must not be reproduced or used without the consent of EXM

Ce dessin est confidentiel et ne doit pas être reproduit ou utilisé sans le consentement de EXM

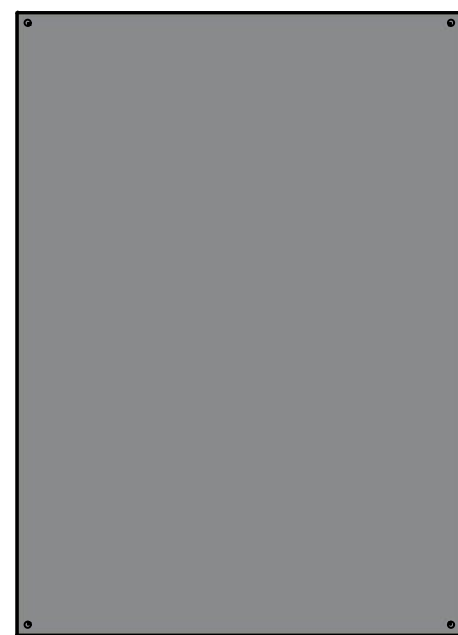

TOP



BACK

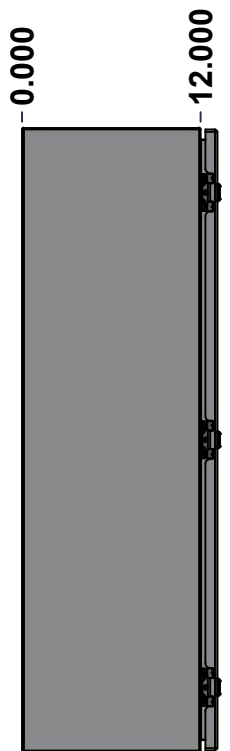

LEFT

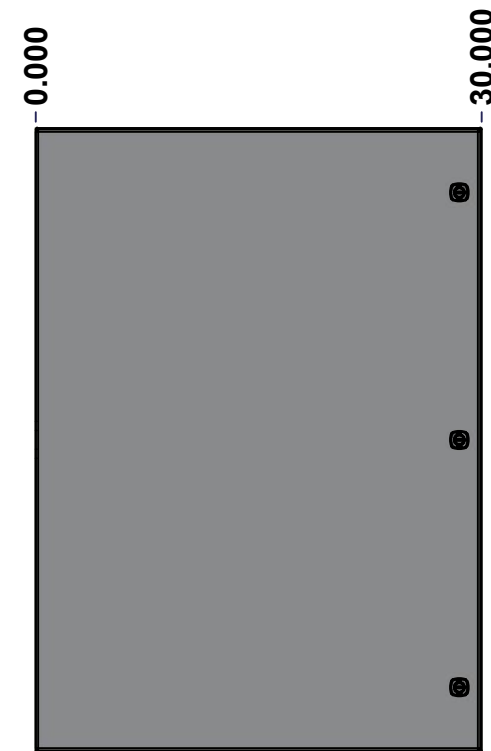

FRONT

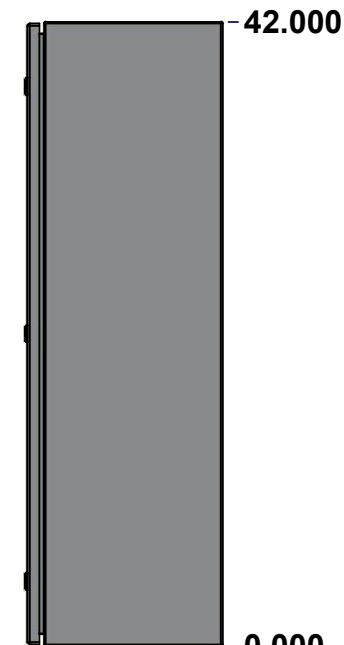

RIGHT



BOTTOM

No.	Revisions	Date	By/Par

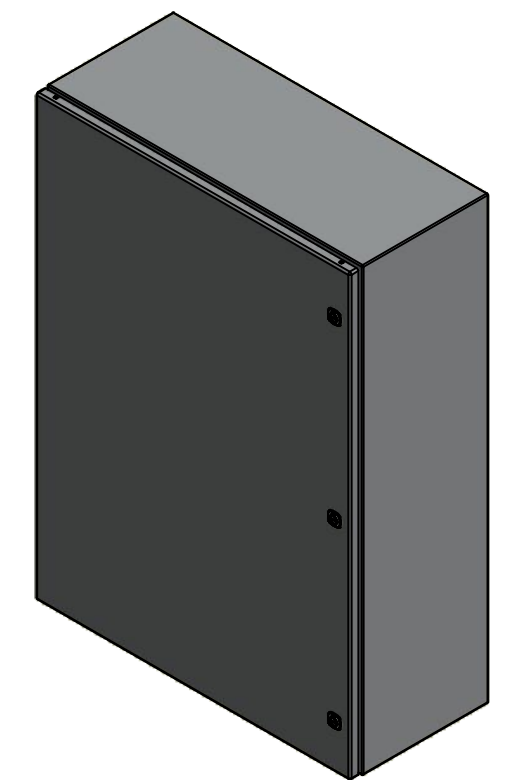

Isometric View

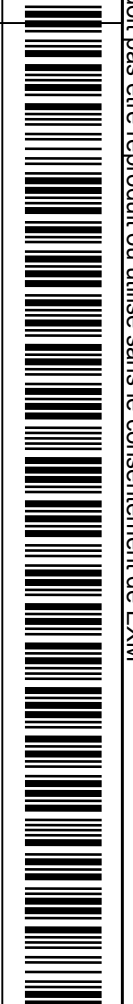

Tél: (450) 979-4373
 Fax: (450) 979-4626
www.exmweb.com

Flatness
Aplatissement
Max 3.0mm
Projection

Customer Client	Date
Drawn By Dessiné Par BoxCad: BoxCad	Date 20-Jun-22
Material Matière 14 Ga Stainless Steel 304 (1.7mm)	
Color Couleur Asa-61 Grey	Finish Fini Smooth
Description 5412ESSP 42" x 30" x 12" Assembly	Detail Rev.
Part Number Numéro Pièce 5412ESSP423012NOIP	Rev. 0

SEE BILL OF MATERIAL ON LAST PAGE

1
9

This drawing is confidential and must not be reproduced or used without the consent of EXM

Ce dessin est confidentiel et ne doit pas être reproduit ou utilisé sans le consentement de EXM

NOTE	
ITEM	DESCRIPTION
1	NEMA 4X Enclosure
2	C/W Standard ground studs on box and cover
3	C/W Standard door stiffener
4	W/O Inner panel
5	C/W Standard inner panel mounting studs
6	C/W Special locks sold separately (Installed)

No.	Revisions	Date	By/Par

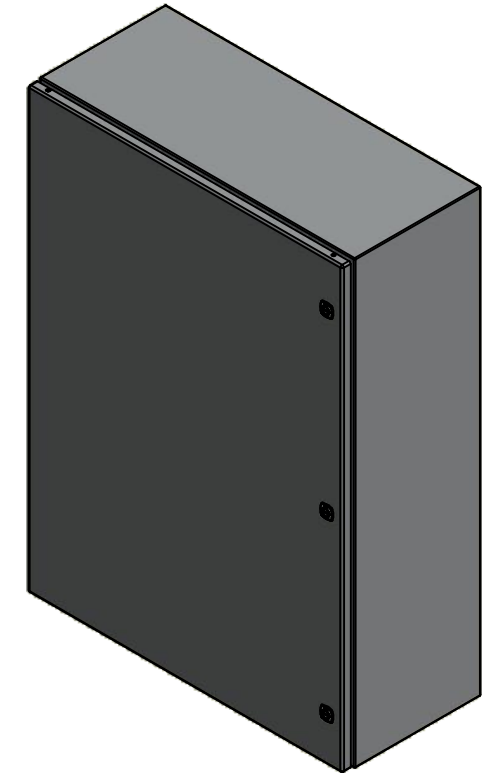

Isometric View



PACKING		
ITEM	QTY	DESCRIPTION
Cardboard sleeve	2	Top and Bottom
Cardboard strip	2	Between back of enclosure and inner panel
Plastic bag	1	To protect cover surface and inside gasket
Cardboard corner	4	To reinforced for the plastic strap tightening
Plastic strap - Black	2	To Squeeze the 2 cardboard sleeve together
Packaging label	3	White label with PN
Plastic strap- Green	2	To secure the enclosure to the wood pallet
Wood Pallet	1	2" deeper and 3" larger than enclosure size

1	880 PP	6	Self Adhesive Print Pocket
1	STK-K-01800	5	5412 ES Accessory Kit
1	5412ESSP423012NOIPC	0	5412ESSP 42" x 30" Cover
1	5412ESSP423012NOIPB	0	5412ESSP 42" x 30" x 12" Body
3	STK-Q-04051-07	8	M6 x 7mm Stainless Steel Hexagon Socket Head Machine Screw with Nyseal
Qty	Part Number	Rev	Description
Parts List			

<p>Tél: (450) 979-4373 Fax: (450) 979-4626 www.exmweb.com</p>	Flatness Aplatissement	Max 3.0mm
	Projection	
Customer Client	Date	
Drawn By Dessiné Par	BoxCad: BoxCad	Date 20-Jun-22
Material Matière	14 Ga Stainless Steel 304 (1.7mm)	
Color Couleur	Asa-61 Grey	Finish Fini Smooth
Description	Detail Rev.	
5412ESSP 42" x 30" x 12" Assembly		
Part Number Numéro Pièce	Rev.	2
5412ESSP423012NOIP	0	9

This drawing is confidential and must not be reproduced or used without the consent of EXM

Ce dessin est confidentiel et ne doit pas être reproduit ou utilisé sans le consentement de EXM



TOP



BACK

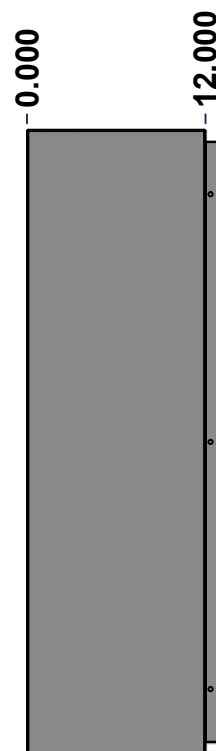

LEFT

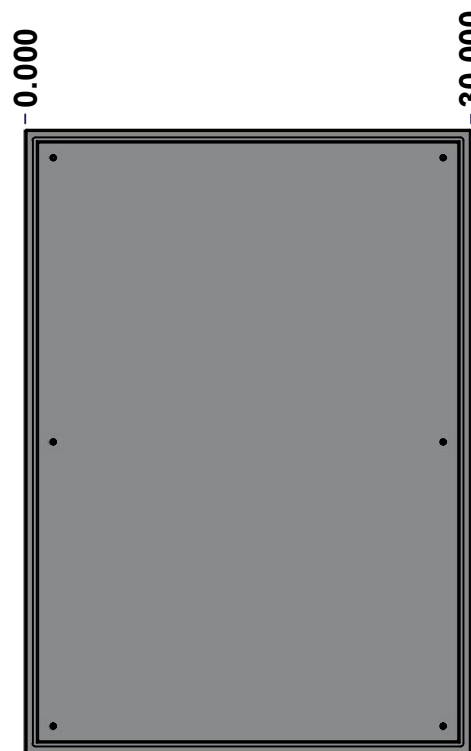

FRONT

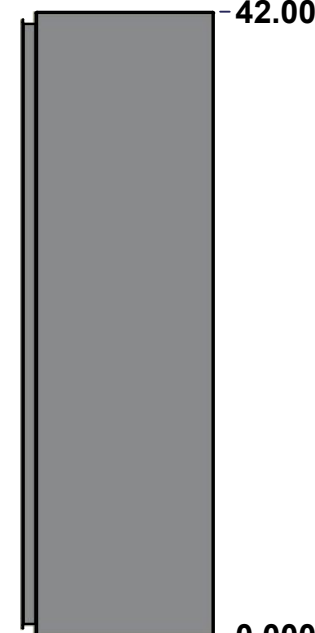

RIGHT



BOTTOM

No.	Revisions	Date	By/Par

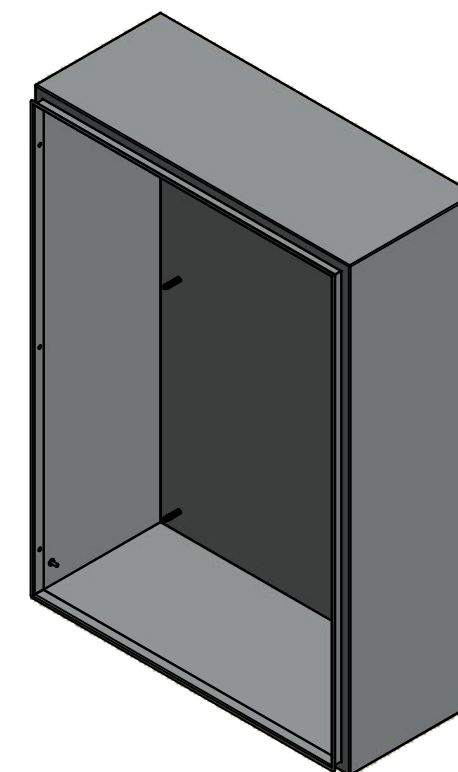

Isometric View



Tél: (450) 979-4373
 Fax: (450) 979-4626
www.exmweb.com

Flatness
Aplatissement

Max 3.0mm

Projection



Customer Client	Date
Drawn By Dessiné Par BoxCad: BoxCad	Date 20-Jun-22
Material Matière 14 Ga Stainless Steel 304 (1.7mm)	
Color Couleur Asa-61 Grey	Finish Fini Smooth
Description 5412ESSP 42" x 30" x 12" Body	Detail Rev.
Part Number Numéro Pièce 5412ESSP423012NOIPB	Rev. 3
	0

SEE BILL OF MATERIAL ON LAST PAGE

This drawing is confidential and must not be reproduced or used without the consent of EXM

Ce dessin est confidentiel et ne doit pas être reproduit ou utilisé sans le consentement de EXM

STANDARD FEATURES ARE NOT LISTED IN THIS HOLE TABLE

HOLE TABLE - LEFT VIEW (CUSTOM FEATURE ONLY)

CUT-OUT	XDIM	YDIM	DESCRIPTION
1	10.500	2.000	GND STUD M6 x 16mm (Inside)

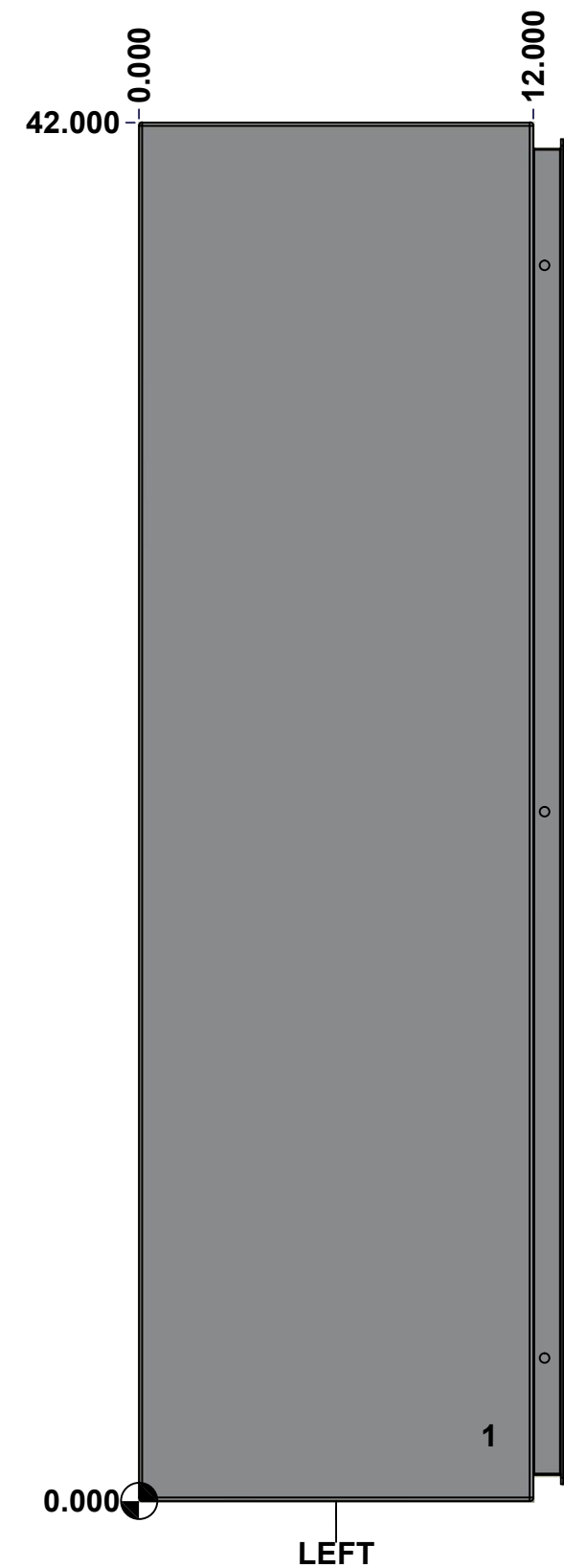

	Description	Status
	5412ESSP 42" x 30" x 12" Body	(NULL)
	Part Number Numéro Pièce	Rev.
	5412ESSP423012NOIPB	0 / 4 9

This drawing is confidential and must not be reproduced or used without the consent of EXM

Ce dessin est confidentiel et ne doit pas être reproduit ou utilisé sans le consentement de EXM

STANDARD FEATURES ARE NOT LISTED IN THIS HOLE TABLE

HOLE TABLE - BACK VIEW (CUSTOM FEATURE ONLY)

CUT-OUT	XDIM	YDIM	DESCRIPTION
1	1.875	1.875	IP STUD M8 x 35mm (Inside)
2	1.875	40.125	IP STUD M8 x 35mm (Inside)
3	28.125	40.125	IP STUD M8 x 35mm (Inside)
4	28.125	1.875	IP STUD M8 x 35mm (Inside)
5	1.875	21.000	IP STUD M8 x 35mm (Inside)
6	28.125	21.000	IP STUD M8 x 35mm (Inside)

7	29.250	0.750	RND Ø0.390
8	29.250	41.250	RND Ø0.390
9	0.750	41.250	RND Ø0.390
10	0.750	0.750	RND Ø0.390

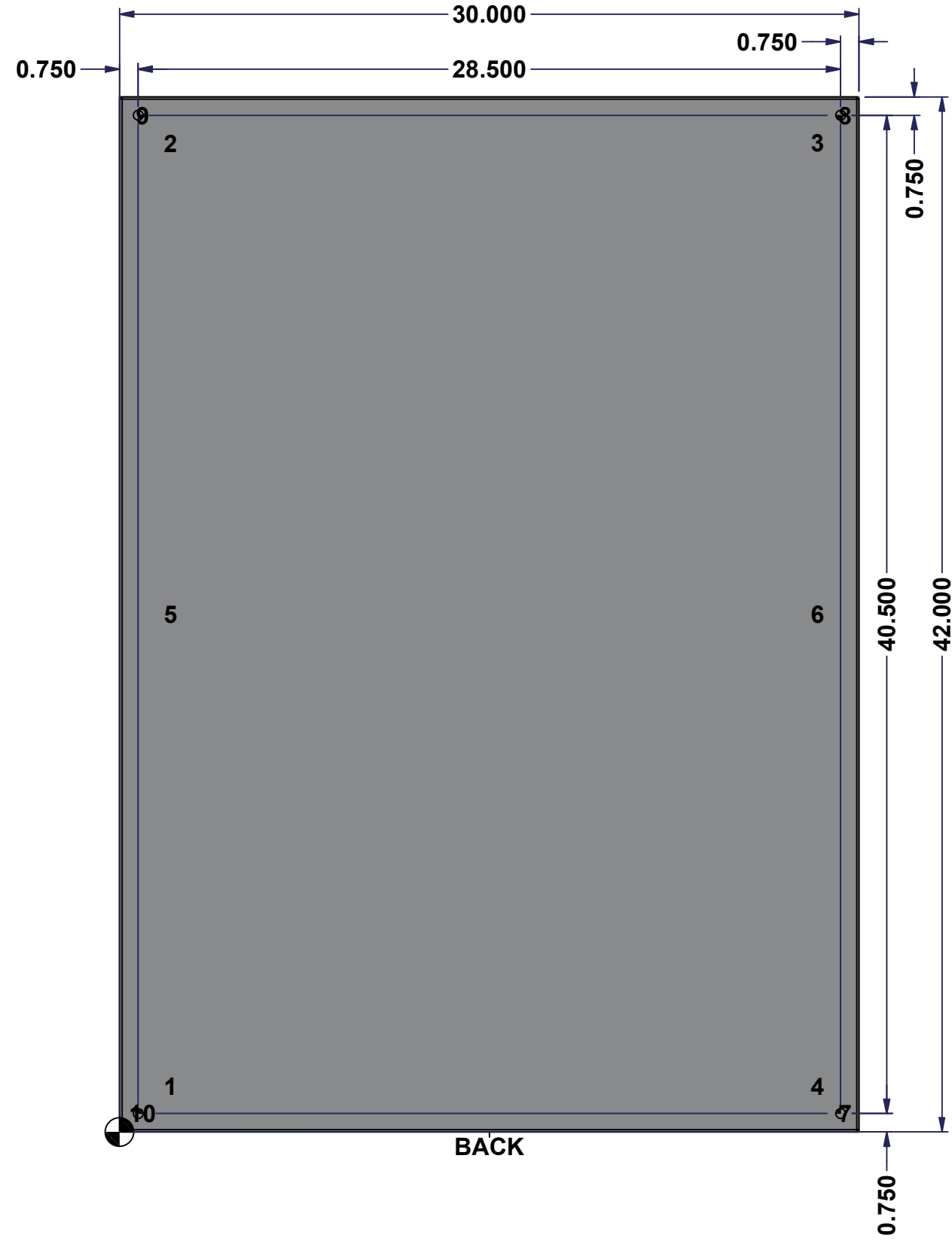

BACK

	Description	Status
	5412ESSP 42" x 30" x 12" Body	(NULL)
	Part Number	Rev.
	Numéro Pièce 5412ESSP423012NOIPB	0 / 5 9

This drawing is confidential and must not be reproduced or used without the consent of EXM

Ce dessin est confidentiel et ne doit pas être reproduit ou utilisé sans le consentement de EXM

No.	Revisions	Date	By/Par

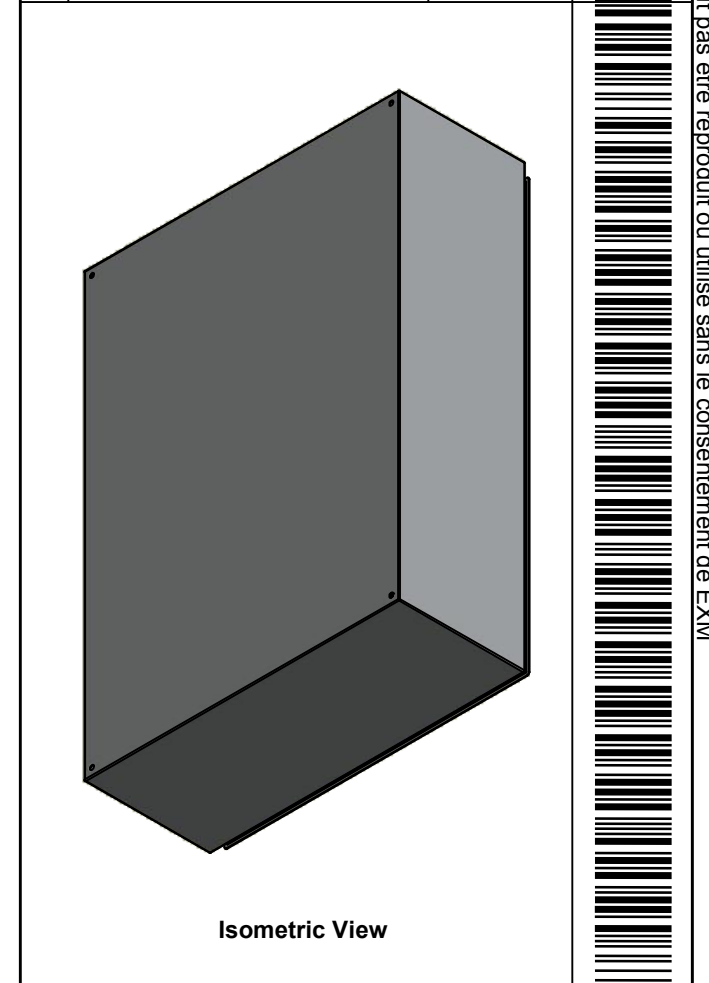

Isometric View

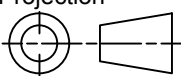

 Tél: (450) 979-4373 Fax: (450) 979-4626 www.exmweb.com		Flatness Aplatissement Max 3.0mm Projection 
Customer Client	Date	
Drawn By Dessiné Par	BoxCad: BoxCad	Date 20-Jun-22
Material Matière	14 Ga Stainless Steel 304 (1.7mm)	
Color Couleur	Asa-61 Grey	Finish Fini Smooth
Description		Detail Rev.
5412ESSP 42" x 30" x 12" Body		
Part Number Numéro Pièce	Rev.	6
5412ESSP423012NOIPB	0	9

1	STK-Q-16085	0	Ground Stud M6 x 16mm Stainless Steel
1	STK-P-02400S	0	Powder Paint (Asa-61 Grey / Smooth)
6	STK-Q-16020	1	Stud M8 x 35mm Stainless Steel
1	5412ESSP423012NOIPB-P	0	5412ESSP 42" x 30" x 12" Body Part
Qty	Part Number	Rev	Description
Parts List			

This drawing is confidential and must not be reproduced or used without the consent of EXM

Ce dessin est confidentiel et ne doit pas être reproduit ou utilisé sans le consentement de EXM

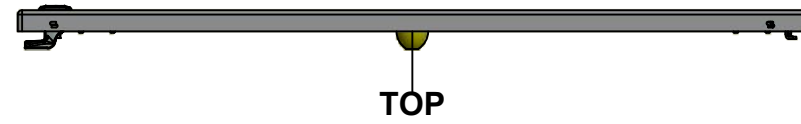

TOP

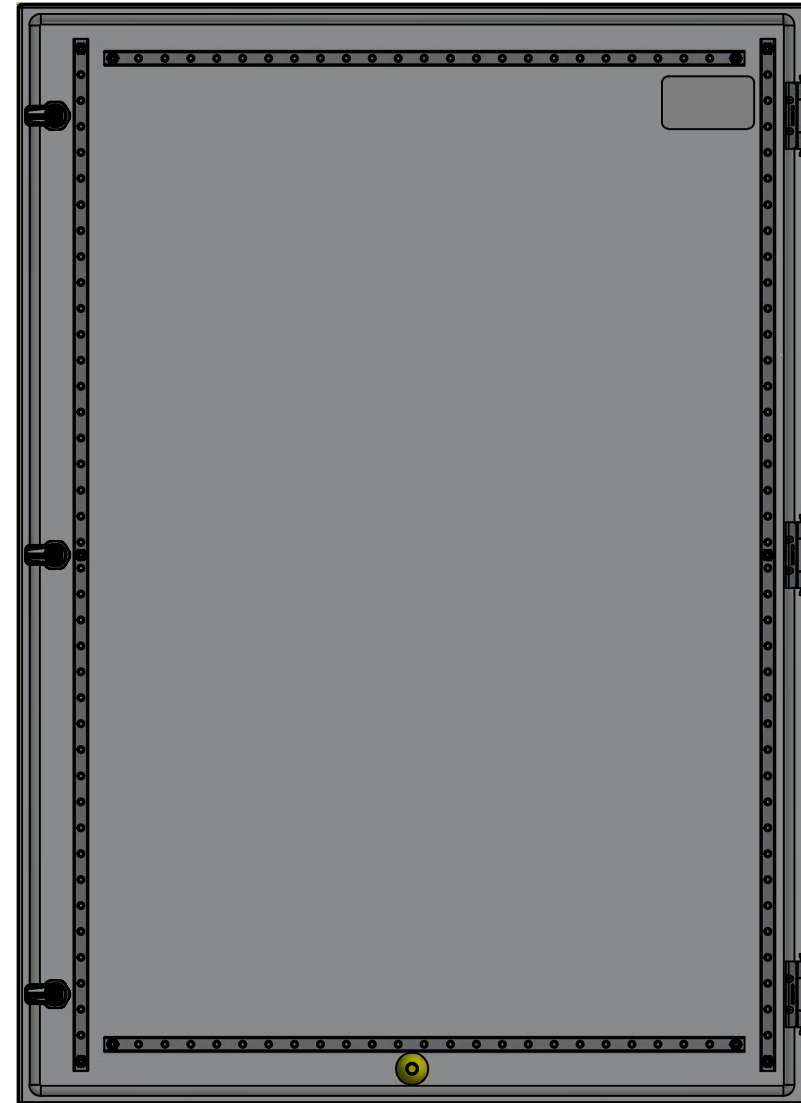

BACK

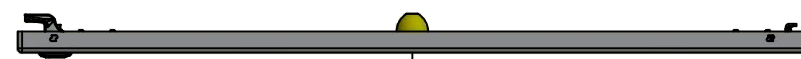

BOTTOM

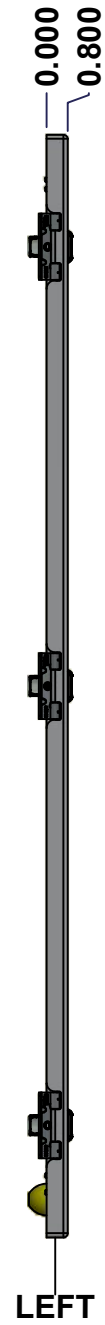

LEFT

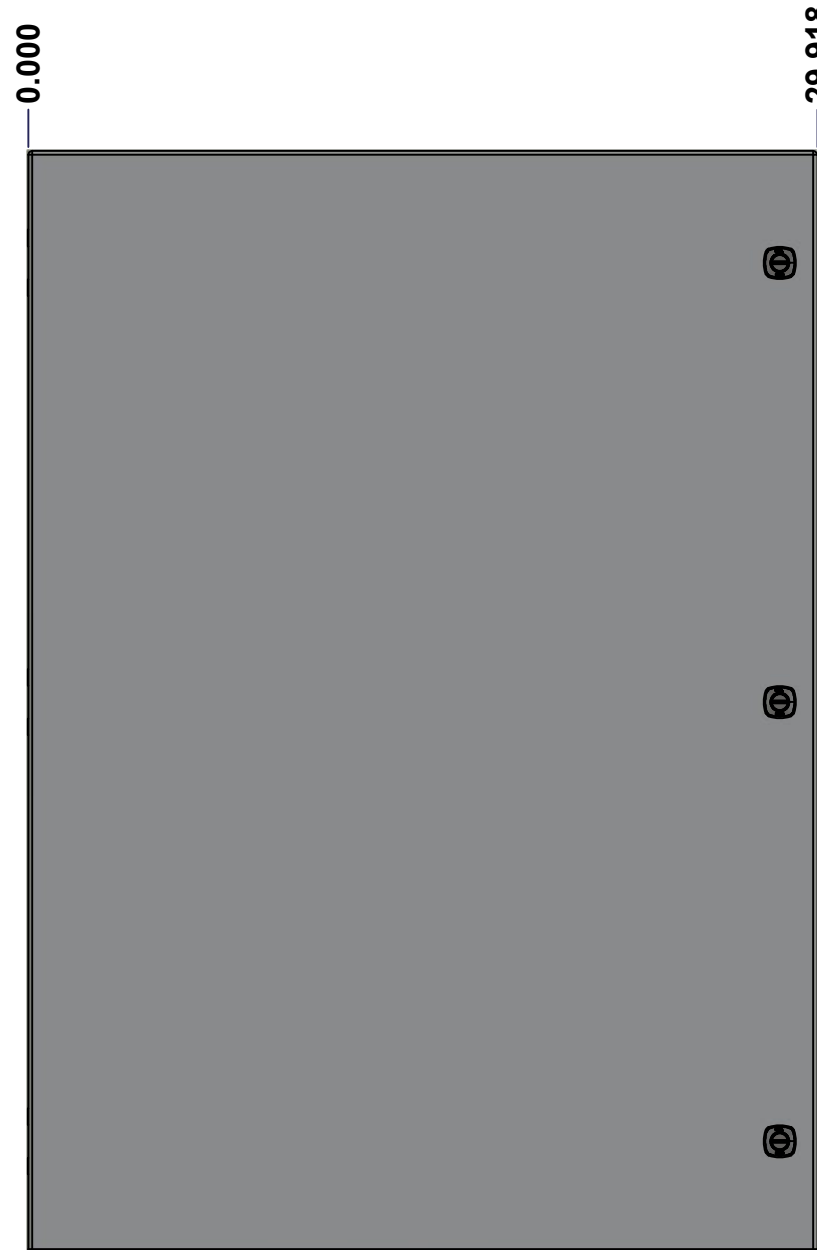

FRONT

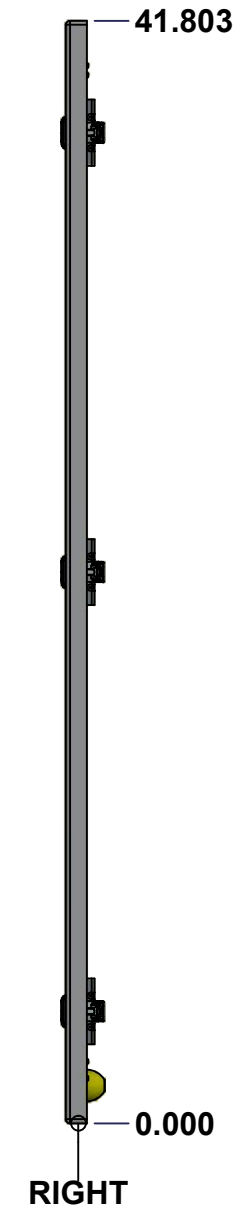

RIGHT

No.	Revisions	Date	By/Par

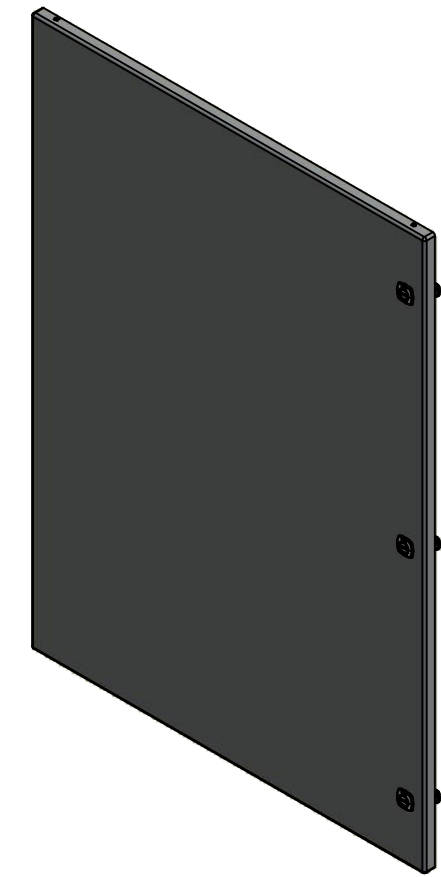

Isometric View

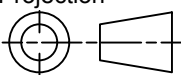

 Tél: (450) 979-4373 Fax: (450) 979-4626 www.exmweb.com		Flatness Aplatissement Max 3.0mm Projection 
Customer Client	Date	
Drawn By Dessiné Par	BoxCad: BoxCad	Date 20-Jun-22
Material Matière	14 Ga Stainless Steel 304 (1.7mm)	
Color Couleur	Asa-61 Grey	Finish Fini Smooth
Description	Detail Rev.	
5412ESSP 42" x 30" Cover		
Part Number Numéro Pièce	Rev. 0	7 9

SEE BILL OF MATERIAL ON LAST PAGE

5412ESSP423012NOIPC

This drawing is confidential and must not be reproduced or used without the consent of EXM

Ce dessin est confidentiel et ne doit pas être reproduit ou utilisé sans le consentement de EXM

STANDARD FEATURES ARE NOT LISTED IN THIS HOLE TABLE

HOLE TABLE - FRONT VIEW (CUSTOM FEATURE ONLY)

CUT-OUT	XDIM	YDIM	DESCRIPTION
1	1.486	1.709	STUD M6 x 18mm (Inside)
2	1.486	40.094	STUD M6 x 18mm (Inside)
3	27.517	40.094	STUD M6 x 18mm (Inside)
4	27.517	1.709	STUD M6 x 18mm (Inside)
5	1.486	20.902	STUD M6 x 18mm (Inside)
6	27.517	20.902	STUD M6 x 18mm (Inside)
7	2.690	2.350	STUD M6 x 18mm (Inside)
8	2.690	39.733	STUD M6 x 18mm (Inside)
9	26.313	39.733	STUD M6 x 18mm (Inside)
10	26.313	2.350	STUD M6 x 18mm (Inside)
11	14.959	1.435	STUD M6 x 18mm (Inside)

12	3.750	38.053	LABEL_EXM (Inside)
13	28.494	37.553	LOCK 880 SCQ4-SLSS6 @ 0.0°
14	28.494	20.902	LOCK 880 SCQ4-SLSS6 @ 0.0°
15	28.494	4.250	LOCK 880 SCQ4-SLSS6 @ 0.0°

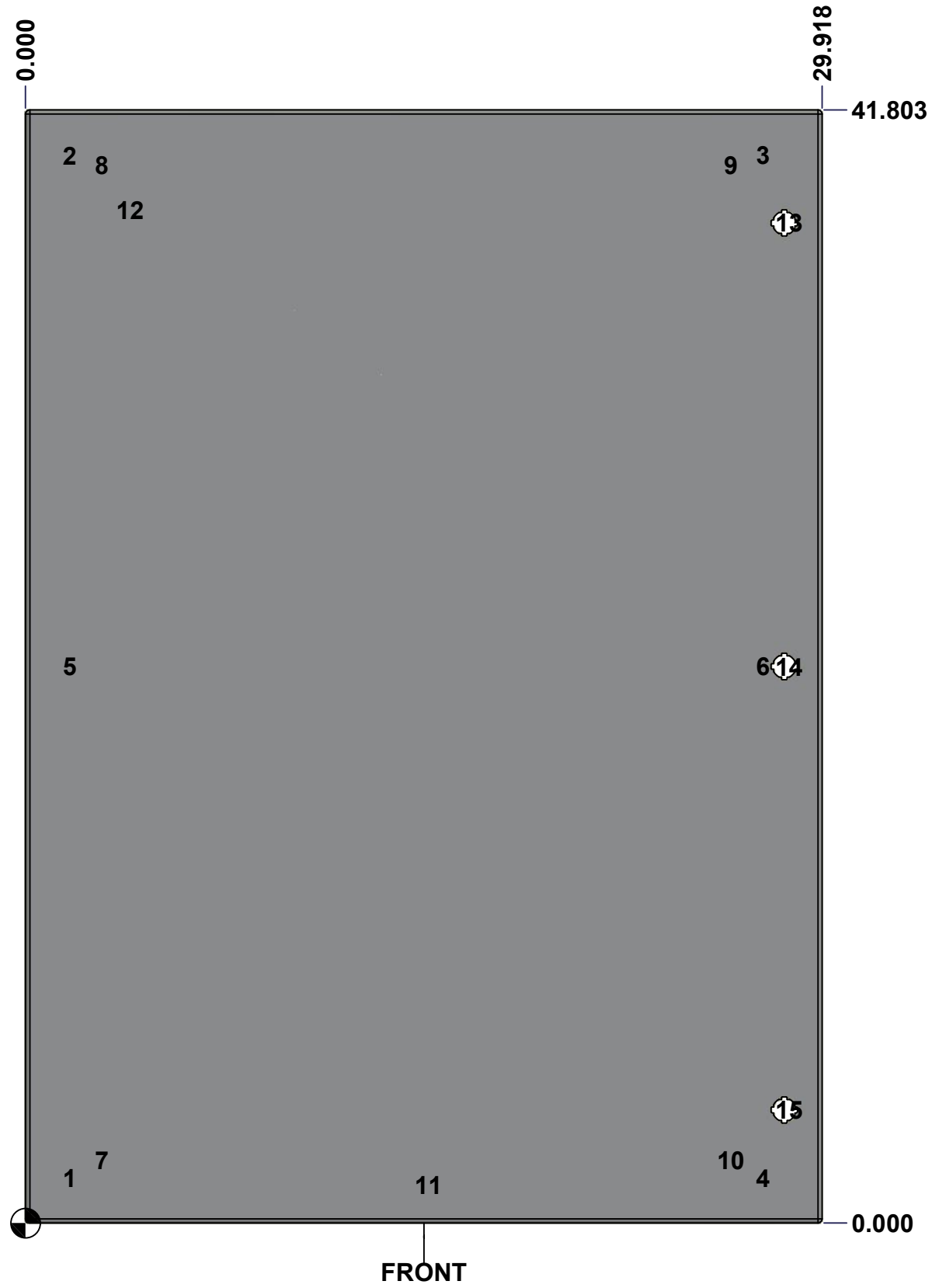

FRONT

	Description	Status
	5412ESSP 42" x 30" Cover	(NULL)
	Part Number Numéro Pièce	Rev.
	5412ESSP423012NOIPC	0
		8
		9

This drawing is confidential and must not be reproduced or used without the consent of EXM

Ce dessin est confidentiel et ne doit pas être reproduit ou utilisé sans le consentement de EXM

No.	Revisions	Date	By/Par

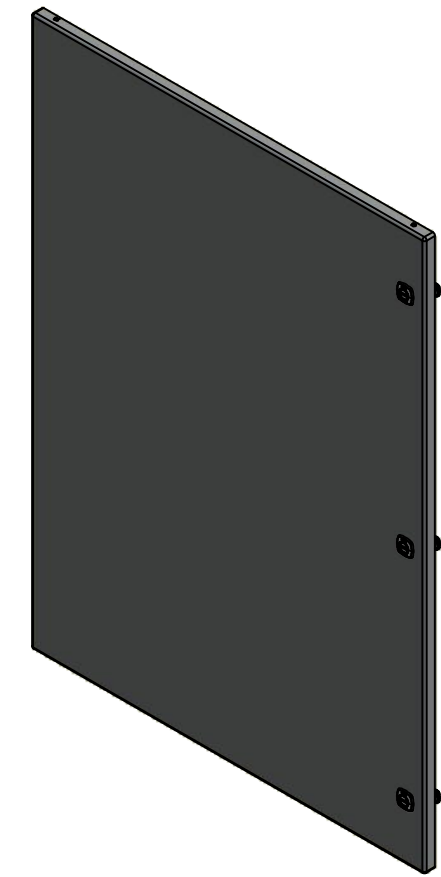

Isometric View

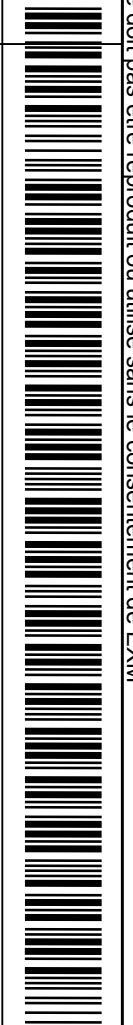

Qty	Part Name	Rev	Description
1	STK-S-00100	0	3.5" x 2" Silver Milar Flexcon Sticker
1	STK-P-02400S	0	Powder Paint (Asa-61 Grey / Smooth)
1	STK-Q-46515	3	5412 ES Door Support with Brass Insert
2	STK-Q-46025-30-3	4	5412 ES Horizontal Door Stiffener 30" (3Pts)
2	STK-Q-46020-42	5	5412 ES Vertical Door Stiffener 42"
11	STK-Q-16070	1	Stud M6 x 18mm Stainless steel
1	5412ESSP423012NOIPG	0	5412ESSP 42" x 30" Cover Gasket Part
1	5412ESSP423012NOIPC-P	0	5412ESSP 42" x 30" Cover Part
3	STK-A-33016	0	5412 ESS Bended Hinge (Body Part)
3	880 SCQ4-SLSS6	7	5412 ESS 1/4 Turn Lock
10	STK-Q-07220	1	M6 Nylon Insert Lock Nut

 Tél: (450) 979-4373 Fax: (450) 979-4626 www.exmweb.com		Flatness Aplatissement Max 3.0mm Projection 
Customer Client	Date	
Drawn By Dessiné Par	BoxCad: BoxCad	Date 20-Jun-22
Material Matière	14 Ga Stainless Steel 304 (1.7mm)	
Color Couleur	Asa-61 Grey	Finish Fini Smooth
Description	Detail Rev.	
5412ESSP 42" x 30" Cover		
Part Number Numéro Pièce	Rev.	9
5412ESSP423012NOIPC	0	9

Parts List