

This drawing is confidential and must not be reproduced or used without the consent of EXM

Ce dessin est confidentiel et ne doit pas être reproduit ou utilisé sans le consentement de EXM

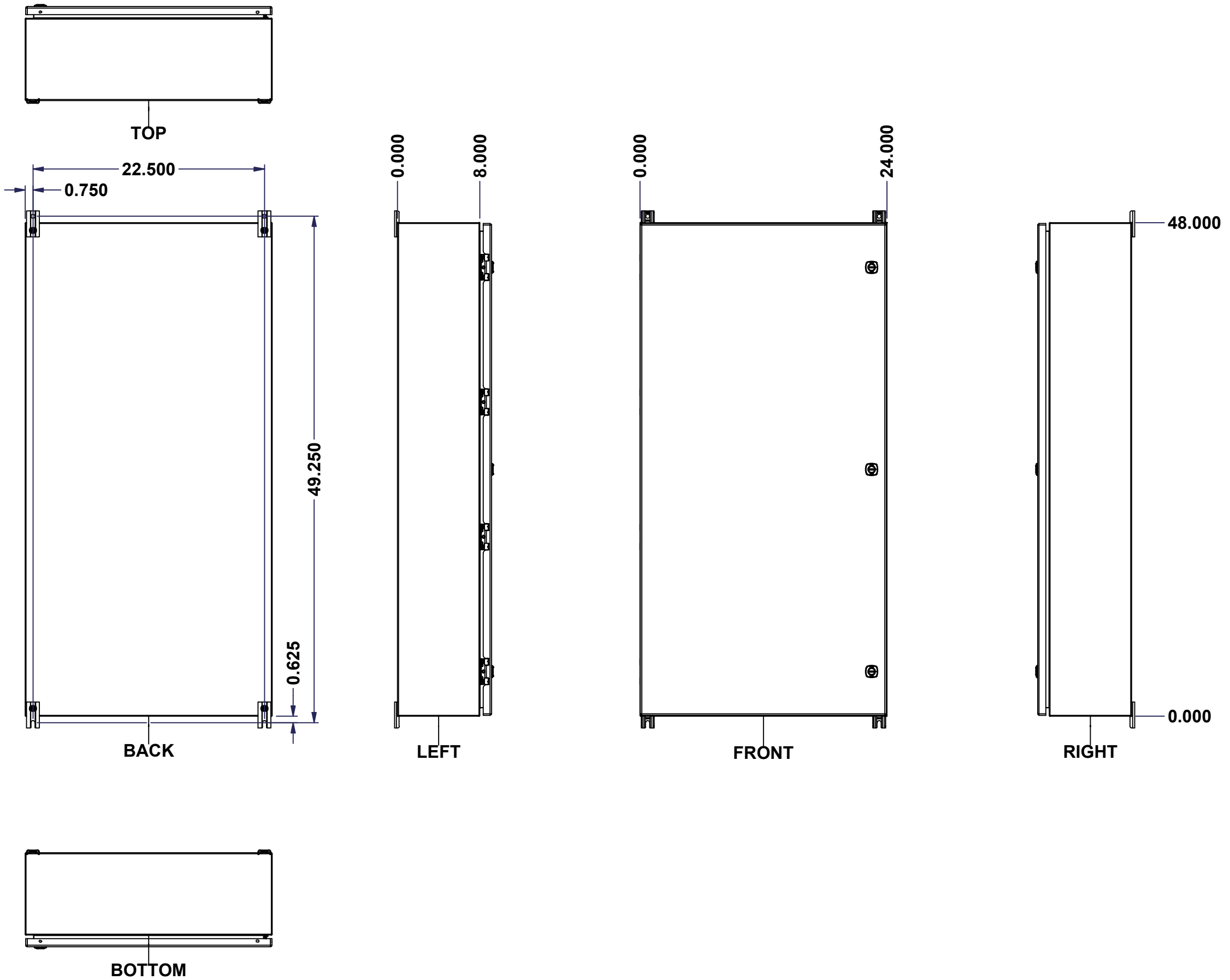

No.	Revisions	Date	By/Par

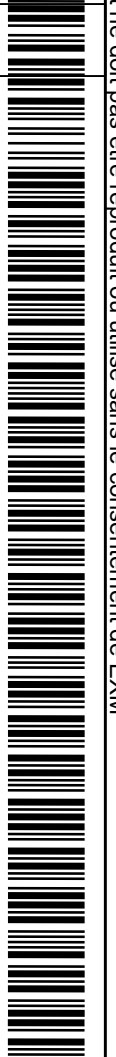
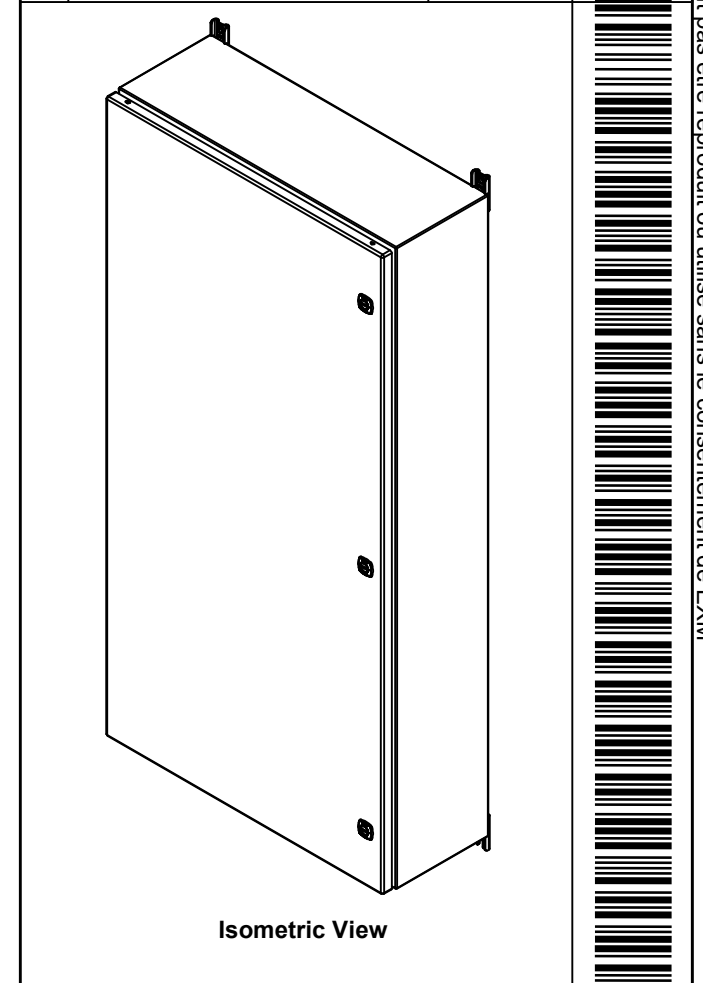

Tél: (450) 979-4373 Fax: (450) 979-4626 <a href="http://www.exmweb.com">www.exmweb.com</a>		Flatness Aplatissement Max 3.0mm Projection 
Customer Client	Date	
Drawn By / Dessiné Par: BoxCad: BoxCad	Date: 04-May-23	
Material / Matière: 16 Ga Stainless Steel 316 (1.4mm)		
Color / Couleur: Asa-61 Grey	Finish / Fini: Smooth	
Description: 5412ESSP 48" x 24" x 8" Assembly	Detail Rev.	
Part Number / Numéro Pièce: 5412ESSP4824086THNOIP	Rev.:	1
SEE BILL OF MATERIAL ON LAST PAGE	0	16

This drawing is confidential and must not be reproduced or used without the consent of EXM

Ce dessin est confidentiel et ne doit pas être reproduit ou utilisé sans le consentement de EXM

NOTE	
ITEM	DESCRIPTION
1	NEMA 4X Enclosure
2	C/W Standard ground studs on box and cover
3	C/W Standard door stiffener
4	W/O Inner panel
5	C/W Standard inner panel mounting studs
6	C/W Special locks sold separately (Installed)
7	C/W 885 ESMF4_OPEN Sold separately (Installed)
8	C/W 885 ESMF4_CLOSE Sold separately (Installed)
9	C/W R5 Insulation (Installed by EXM)

No.	Revisions	Date	By/Par

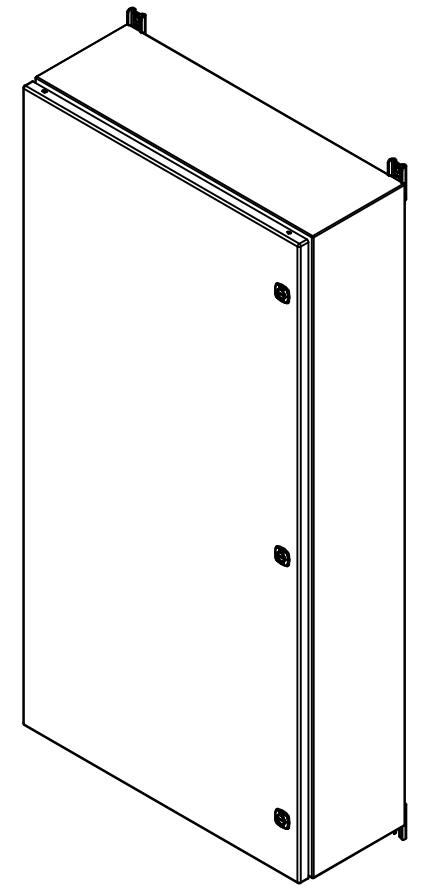

Isometric View



PACKING		
ITEM	QTY	DESCRIPTION
Cardboard sleeve	2	Top and Bottom
Cardboard strip	2	Between back of enclosure and inner panel
Plastic bag	1	To protect cover surface and inside gasket
Cardboard corner	4	To reinforced for the plastic strap tightening
Plastic strap - Black	2	To Squeeze the 2 cardboard sleeve together
Packaging label	3	White label with PN
Plastic strap- Green	2	To secure the enclosure to the wood pallet
Wood Pallet	1	2" deeper and 3" larger than enclosure size

6	STK-Q-00600	2	M12 to M8 Adaptor
1	STK-K-01800	5	5412 ES Accessory Kit
1	5412ESSP4824086THNOI PC	0	5412ESSP 48" x 24" Cover
1	5412ESSP4824086THNOI PB	0	5412ESSP 48" x 24" x 8" Body
4	STK-Q-04051-08	1	M6 x 8mm Stainless Steel Hexagon Socket Head Machine Screw with Nyseal
Qty	Part Number	Rev	Description
Parts List			

		Flatness Aplatissement Max 3.0mm Projection 	
Tél: (450) 979-4373 Fax: (450) 979-4626 <a href="http://www.exmweb.com">www.exmweb.com</a>		Customer Client Date	
Drawn By Dessiné Par BoxCad: BoxCad		Date 04-May-23	
Material Matière 16 Ga Stainless Steel 316 (1.4mm)		Color Couleur Asa-61 Grey	
Finish Fini Smooth		Description 5412ESSP 48" x 24" x 8" Assembly	
Part Number Numéro Pièce <b>5412ESSP4824086THNOIP</b>		Detail Rev. Rev. 2 0	

This drawing is confidential and must not be reproduced or used without the consent of EXM

Ce dessin est confidentiel et ne doit pas être reproduit ou utilisé sans le consentement de EXM

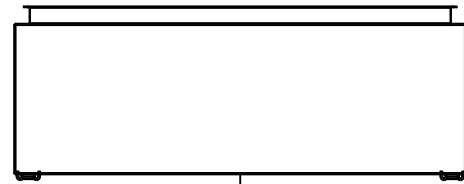

TOP

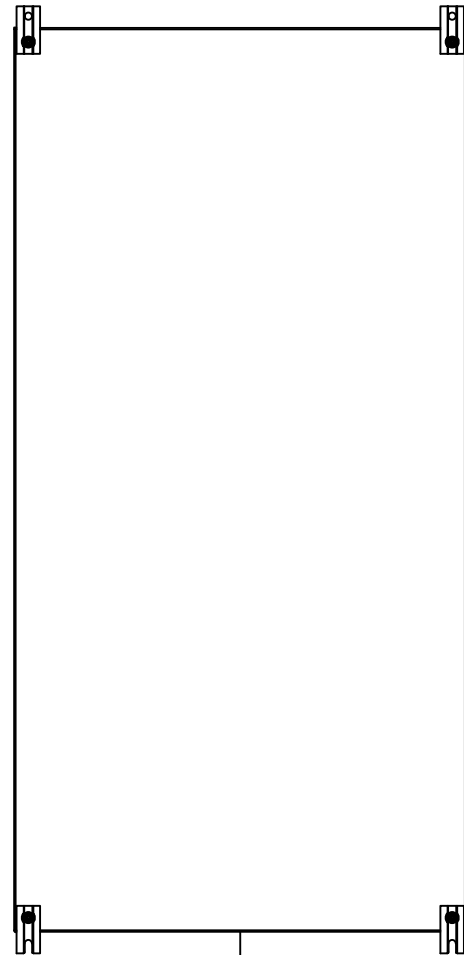

BACK

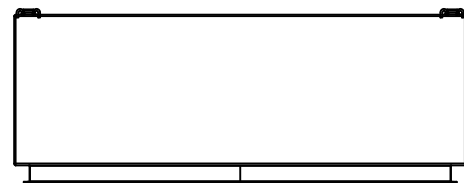

BOTTOM

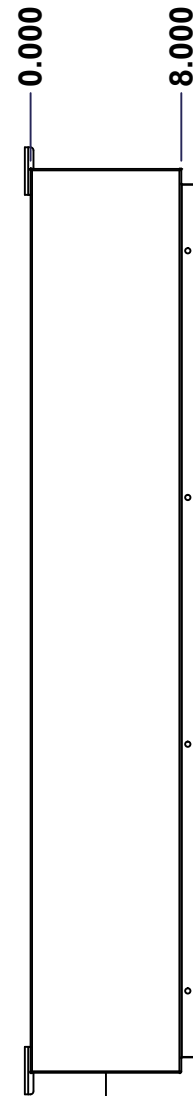

LEFT

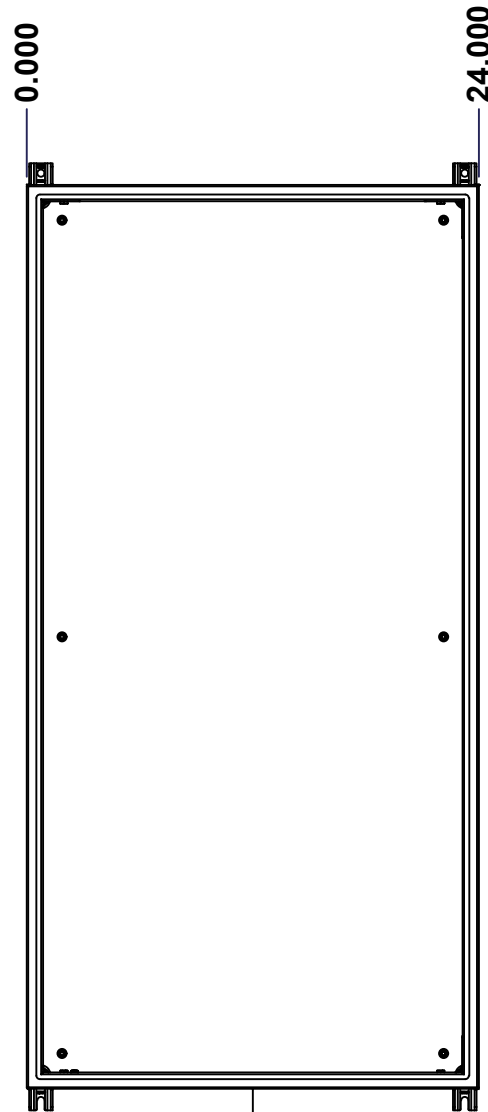

FRONT

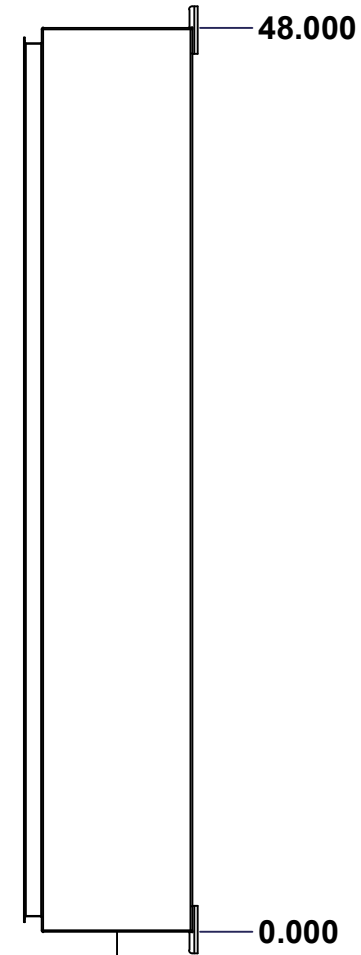

RIGHT

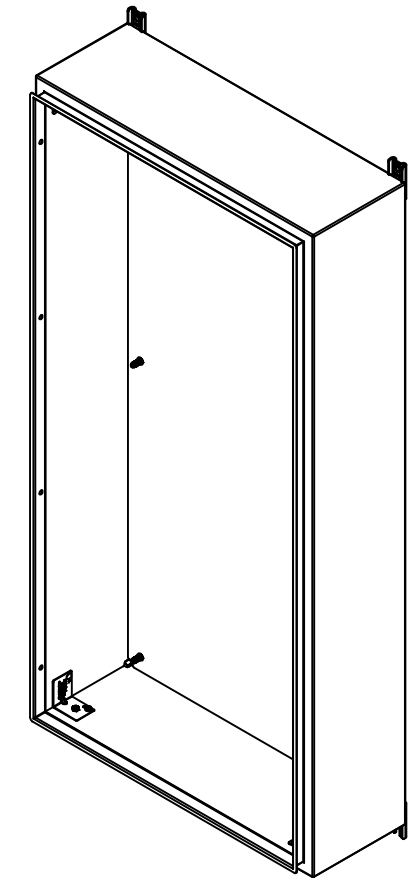

Isometric View

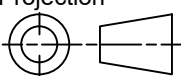

No.	Revisions	Date	By/Par

 Tél: (450) 979-4373 Fax: (450) 979-4626 <a href="http://www.exmweb.com">www.exmweb.com</a>		Flatness Aplatissement Max 5.0mm Projection 
Customer Client	Date	
Drawn By Dessiné Par	BoxCad: BoxCad	Date 04-May-23
Material Matière	16 Ga Stainless Steel 316 (1.4mm)	
Color Couleur	Asa-61 Grey	Finish Fini Smooth
Description	Detail Rev.	
5412ESSP 48" x 24" x 8" Body		
Part Number Numéro Pièce	Rev. 3	0

SEE BILL OF MATERIAL ON LAST PAGE 5412ESSP4824086THNOIP

This drawing is confidential and must not be reproduced or used without the consent of EXM

Ce dessin est confidentiel et ne doit pas être reproduit ou utilisé sans le consentement de EXM

STANDARD FEATURES ARE NOT LISTED IN THIS HOLE TABLE			
HOLE TABLE - TOP VIEW (CUSTOM FEATURE ONLY)			
CUT-OUT	XDIM	YDIM	DESCRIPTION
1	2.000	6.500	INSUL. STUD M6 x 18mm (Inside)
2	22.000	6.500	INSUL. STUD M6 x 18mm (Inside)

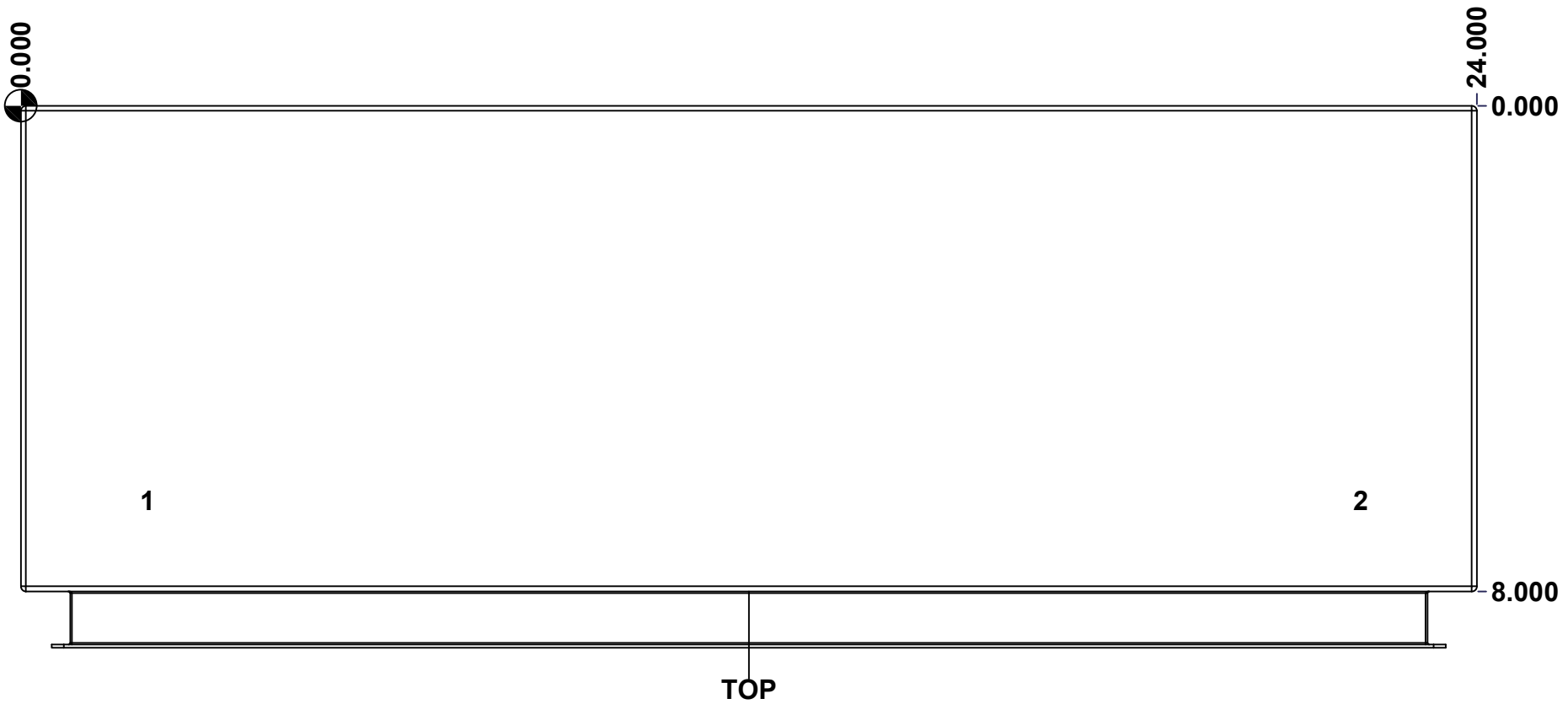

	Description	Status
	5412ESSP 48" x 24" x 8" Body	(NULL)
	Part Number Numéro Pièce	Rev.
	<b>5412ESSP4824086THNOIPB</b>	4 <b>0</b>
		16

This drawing is confidential and must not be reproduced or used without the consent of EXM

Ce dessin est confidentiel et ne doit pas être reproduit ou utilisé sans le consentement de EXM

<b>STANDARD FEATURES ARE NOT LISTED IN THIS HOLE TABLE</b>			
<b>HOLE TABLE - BOTTOM VIEW (CUSTOM FEATURE ONLY)</b>			
CUT-OUT	XDIM	YDIM	DESCRIPTION
1	2.000	6.500	INSUL. STUD M6 x 18mm (Inside)
2	22.000	6.500	INSUL. STUD M6 x 18mm (Inside)



	Description	Status
	5412ESSP 48" x 24" x 8" Body	(NULL)
	Part Number Numéro Pièce	Rev. 5
	<b>5412ESSP4824086THNOIPB 0</b>	16

This drawing is confidential and must not be reproduced or used without the consent of EXM

Ce dessin est confidentiel et ne doit pas être reproduit ou utilisé sans le consentement de EXM

**STANDARD FEATURES ARE NOT LISTED IN THIS HOLE TABLE**

**HOLE TABLE - BACK VIEW (CUSTOM FEATURE ONLY)**

CUT-OUT	XDIM	YDIM	DESCRIPTION
1	1.875	1.875	IP STUD M8 x 35mm (Inside)
2	1.875	46.125	IP STUD M8 x 35mm (Inside)
3	22.125	46.125	IP STUD M8 x 35mm (Inside)
4	22.125	1.875	IP STUD M8 x 35mm (Inside)
5	1.875	24.000	IP STUD M8 x 35mm (Inside)
6	22.125	24.000	IP STUD M8 x 35mm (Inside)
-----			
7	23.250	0.000	FOOT 885 ESMF4_OPEN
8	0.750	0.000	FOOT 885 ESMF4_OPEN
9	23.250	48.000	FOOT 885 ESMF4_CLOSE
10	0.750	48.000	FOOT 885 ESMF4_CLOSE

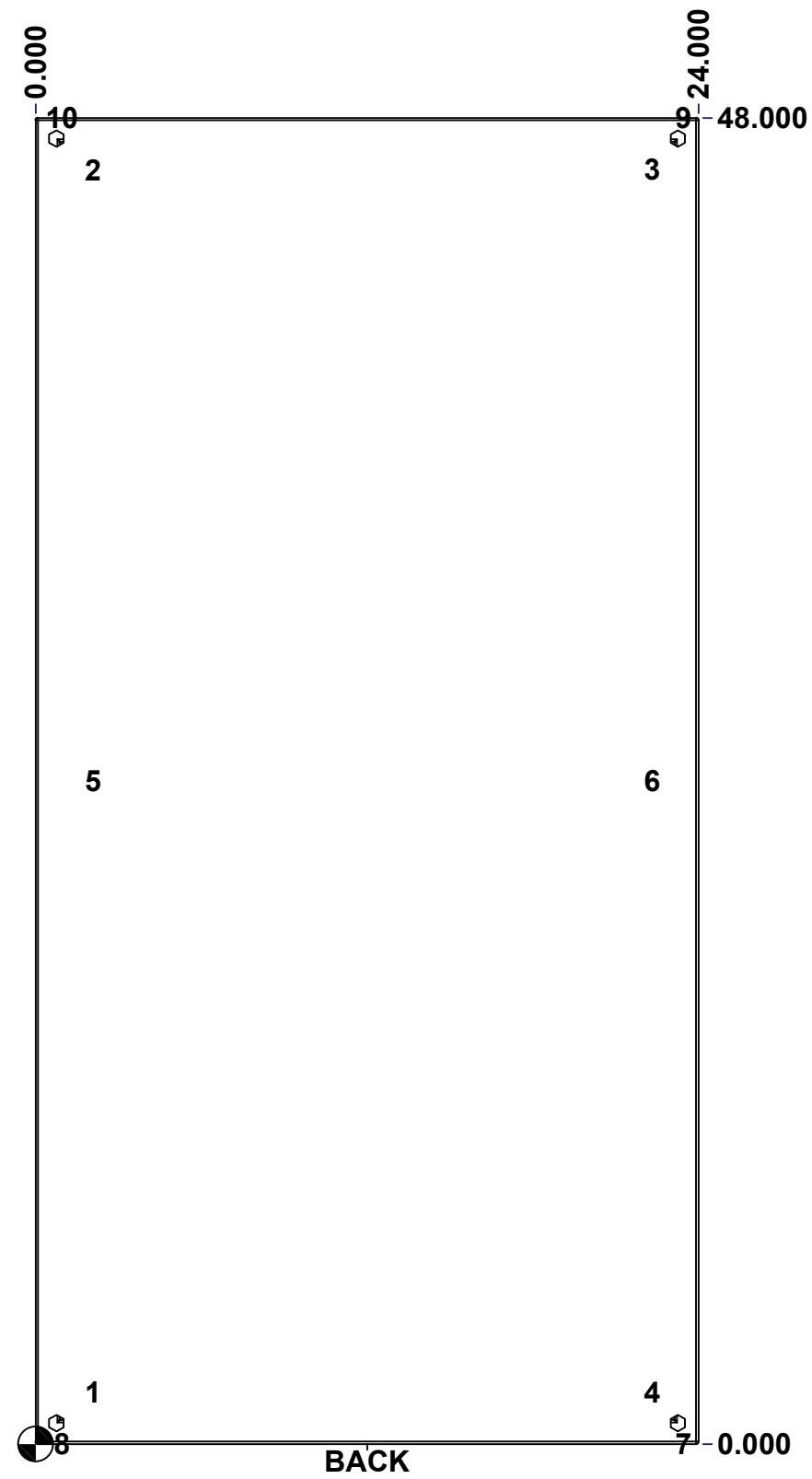

	Description	Status
	5412ESSP 48" x 24" x 8" Body	(NULL)
	Part Number Numéro Pièce	Rev.
	<b>5412ESSP4824086THNOIPB</b>	6 <b>0</b>
		16

This drawing is confidential and must not be reproduced or used without the consent of EXM

Ce dessin est confidentiel et ne doit pas être reproduit ou utilisé sans le consentement de EXM

No.	Revisions	Date	By/Par

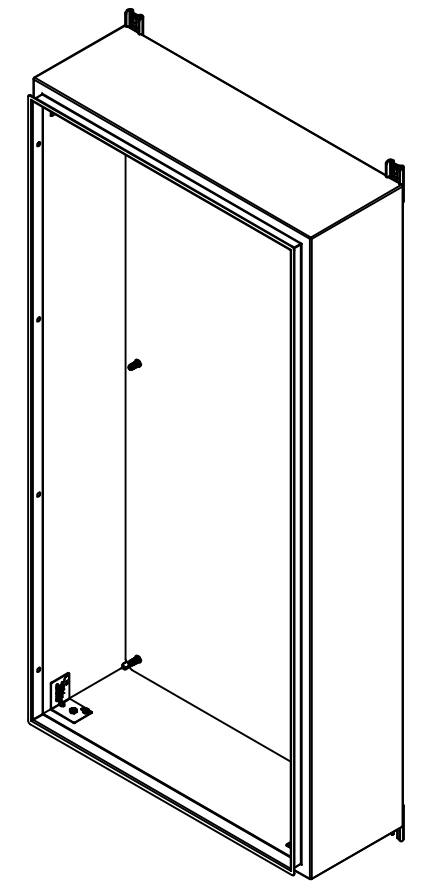

Isometric View



2	885ESMF4-FEET	0	885 ESMF4 Stainless Steel Mounting Foot
4	RIVET_NUT_SS_M10_FH_CE	0	Stainless Steel Rivet Nut M10 (Low Profile Close End)
4	STK-Q-06670	2	M10 x 16mm Stainless Steel Machine Screw
2	885ESMF4-FEET-A	0	885 ESMF4 Stainless Steel Mounting Foot (Opened Slot)
1	STK-K-70554	3	5412 ESTH Accessory Kit
1	5412ESSP4824086THNOI-PI-RS	0	5412ESSP 48" x 24" Right Insulation
1	5412ESSP4824086THNOI-PI-LS	0	5412ESSP 48" x 24" Left Insulation
1	5412ESSP4824086THNOI-PI-BT	0	5412ESSP 48" x 24" Top and Bottom Insulation
1	5412ESSP4824086THNOI-PI-TP	0	5412ESSP 48" x 24" Top and Bottom Insulation
1	5412ESSP4824086THNOI-PI-B	0	5412ESSP 48" x 24" Back Insulation
4	STK-Q-16070	1	Stud M6 x 18mm Stainless steel
1	STK-P-02400S	0	Powder Paint (Asa-61 Grey / Smooth)
6	STK-Q-16020	1	Stud M8 x 35mm Stainless Steel
1	5412ESSP4824086THNOI-PB-P	0	5412ESSP 48" x 24" x 8" Body Part

Qty	Part Number	Rev	Description
Parts List			



Tél: (450) 979-4373  
Fax: (450) 979-4626  
[www.exmweb.com](http://www.exmweb.com)

Flatness / Aplatissement: Max 5.0mm

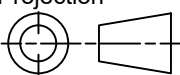
Projection: 

Customer / Client	Date
Drawn By / Dessiné Par: BoxCad: BoxCad	Date: 04-May-23
Material / Matière: 16 Ga Stainless Steel 316 (1.4mm)	
Color / Couleur: Asa-61 Grey	Finish / Fini: Smooth
Description: 5412ESSP 48" x 24" x 8" Body	Detail Rev.
Part Number / Numéro Pièce: <b>5412ESSP4824086THNOIPB</b>	Rev. 7

This drawing is confidential and must not be reproduced or used without the consent of EXM

Ce dessin est confidentiel et ne doit pas être reproduit ou utilisé sans le consentement de EXM

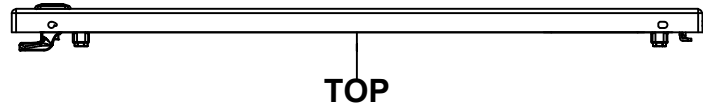

TOP

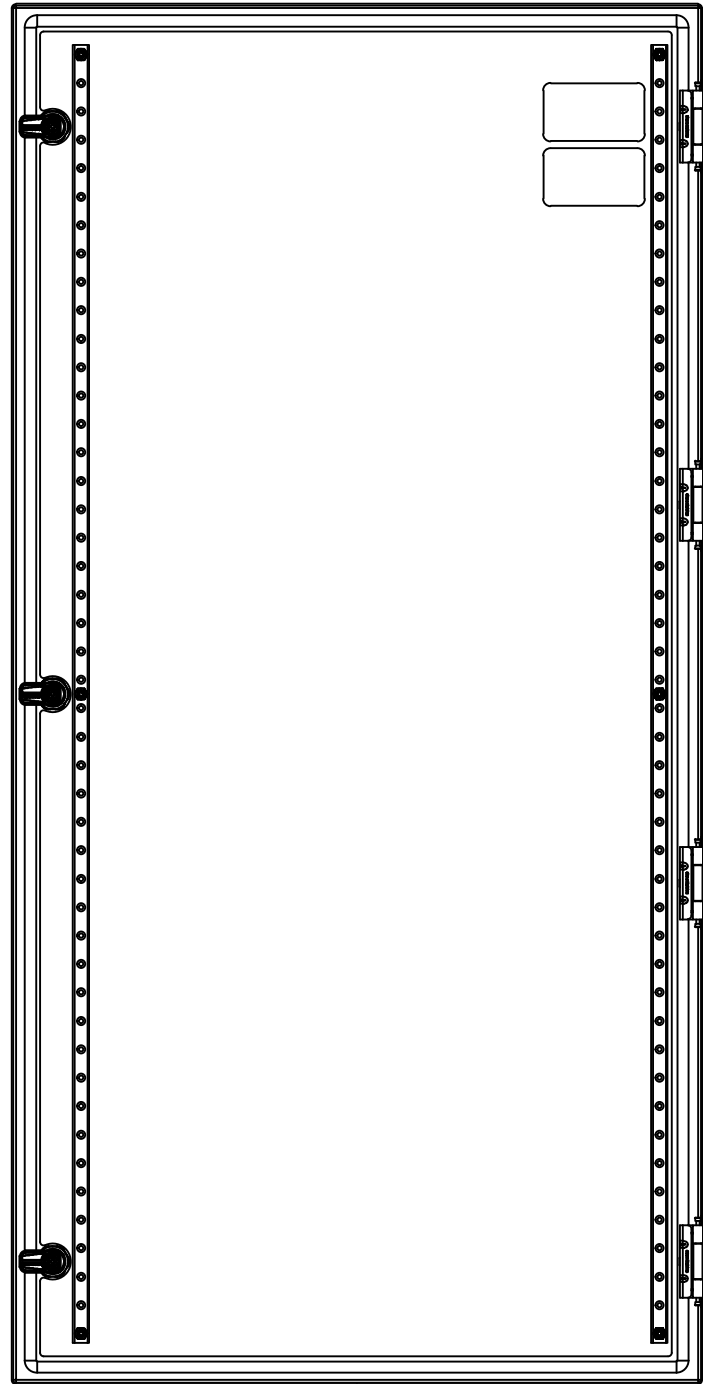

BACK

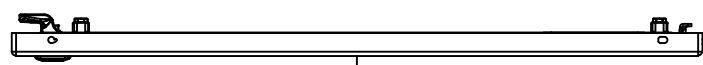

BOTTOM

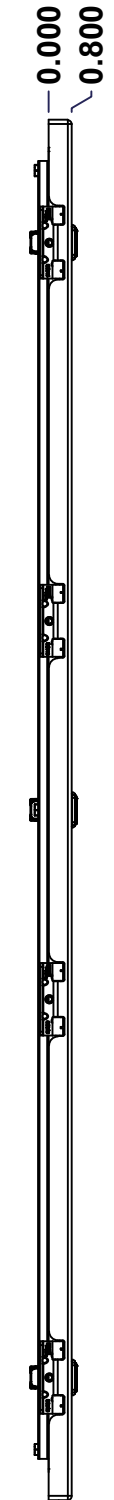

LEFT

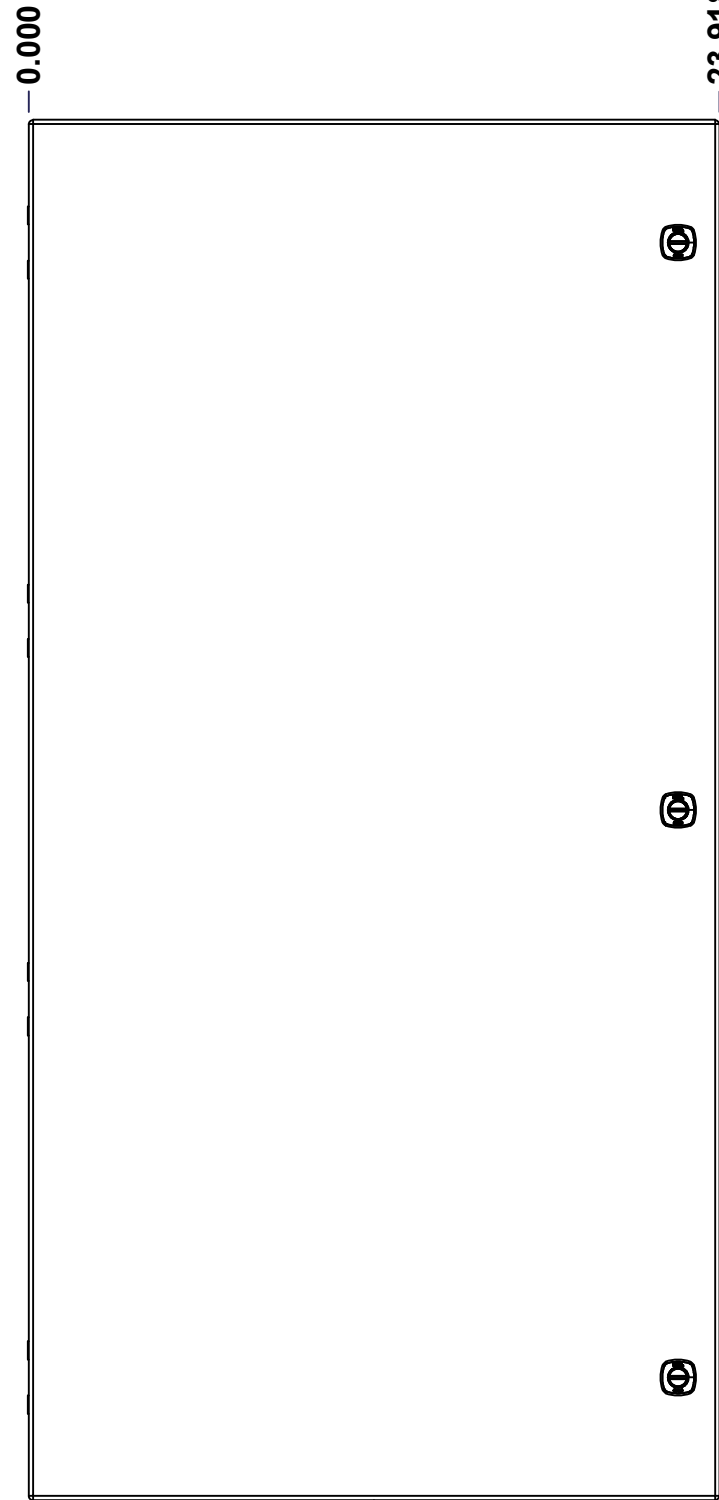

FRONT

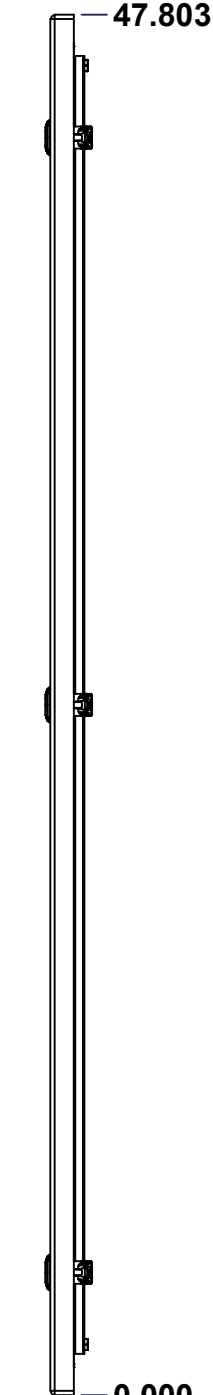

RIGHT

0.000  
0.800

0.000

23.918

47.803

0.000

No.	Revisions	Date	By/Par

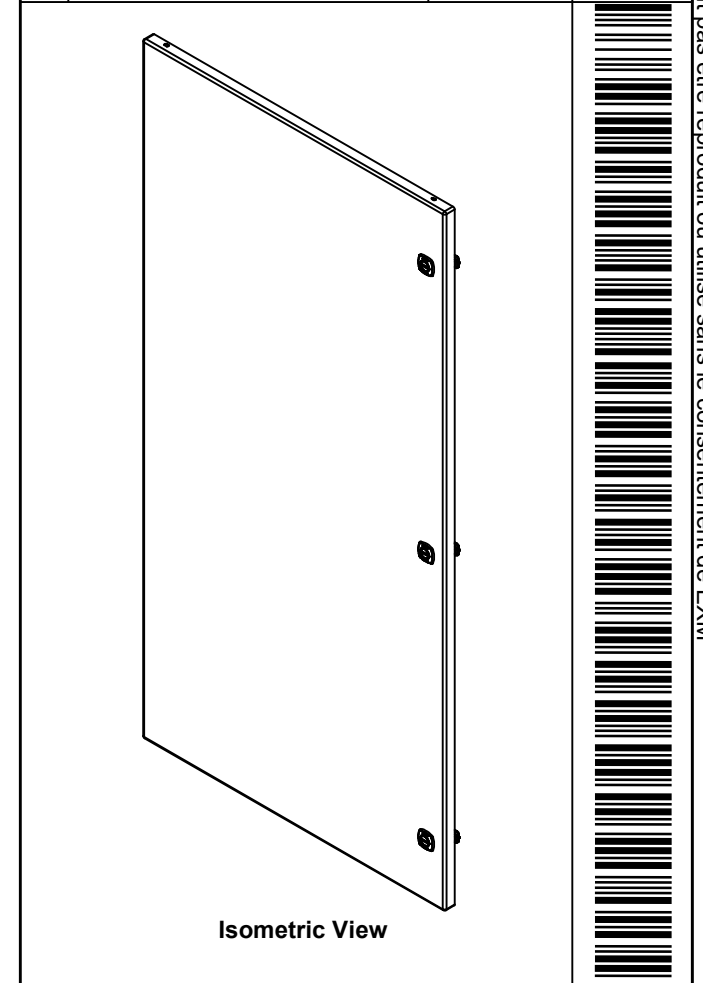

Isometric View



Tél: (450) 979-4373 Fax: (450) 979-4626 <a href="http://www.exmweb.com">www.exmweb.com</a>		Flatness Aplatissement Max 5.0mm Projection 
Customer Client	Date	
Drawn By Dessiné Par	BoxCad: BoxCad	Date 04-May-23
Material Matière	16 Ga Stainless Steel 316 (1.4mm)	
Color Couleur	Asa-61 Grey	Finish Fini Smooth
Description	Detail Rev.	
5412ESSP 48" x 24" Cover		
Part Number Numéro Pièce	Rev. 8	0

SEE BILL OF MATERIAL ON LAST PAGE 5412ESSP4824086THNOIPC 0 16



This drawing is confidential and must not be reproduced or used without the consent of EXM

Ce dessin est confidentiel et ne doit pas être reproduit ou utilisé sans le consentement de EXM

**STANDARD FEATURES ARE NOT LISTED IN THIS HOLE TABLE**

**HOLE TABLE - FRONT VIEW (CUSTOM FEATURE ONLY)**

CUT-OUT	XDIM	YDIM	DESCRIPTION
1	1.486	1.756	STUD M6 x 18mm (Inside)
2	1.486	46.047	STUD M6 x 18mm (Inside)
3	21.517	46.047	STUD M6 x 18mm (Inside)
4	21.517	1.756	STUD M6 x 18mm (Inside)
5	1.486	23.902	STUD M6 x 18mm (Inside)
6	21.517	23.902	STUD M6 x 18mm (Inside)
-----			
7	22.494	43.553	880 SCQ4-SLSS6
8	22.494	23.902	880 SCQ4-SLSS6
9	22.494	4.250	880 SCQ4-SLSS6

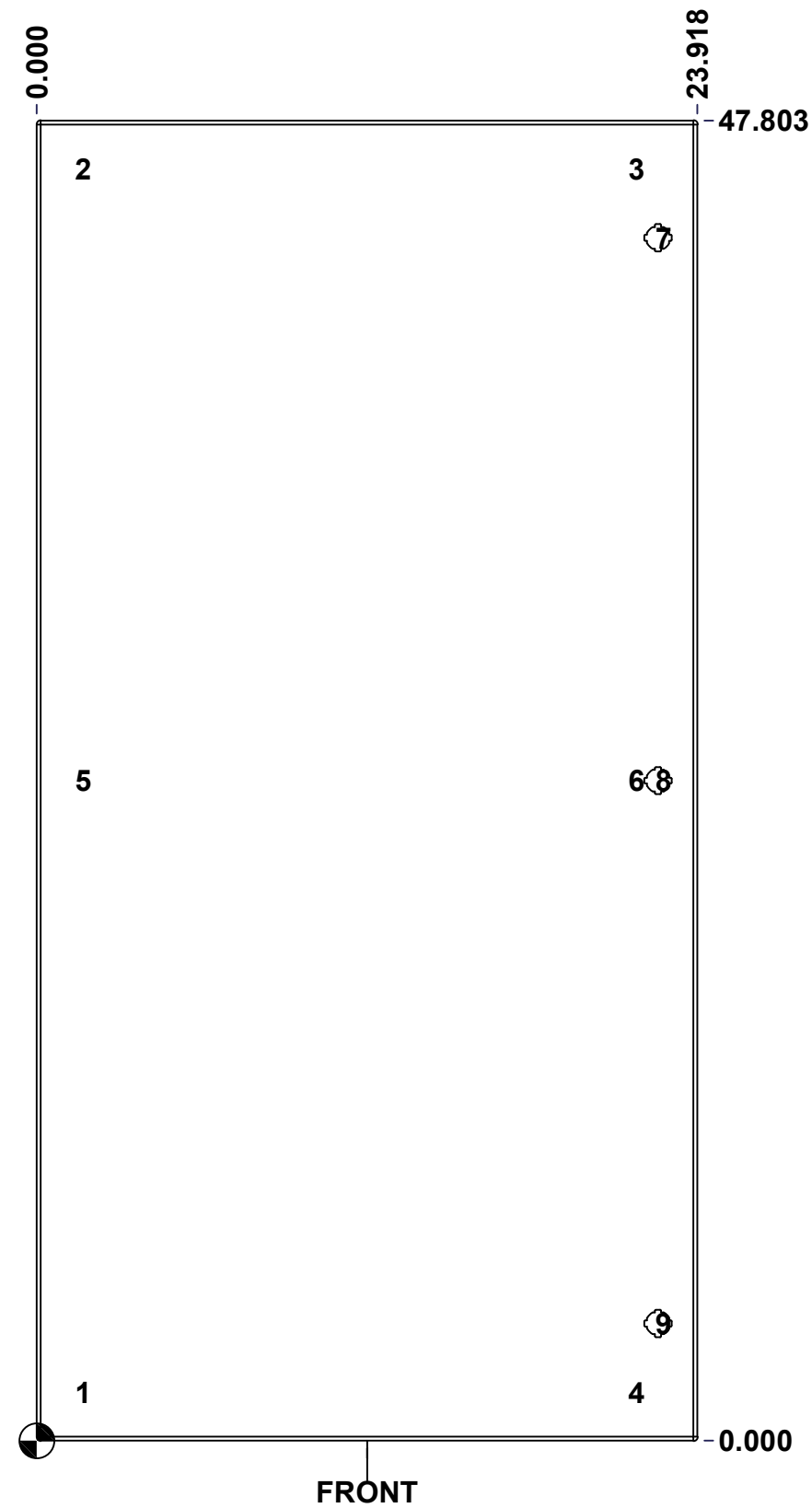

	Description	Status
	5412ESSP 48" x 24" Cover	(NULL)
	Part Number Numéro Pièce	Rev. 9
	<b>5412ESSP4824086THNOIPC</b>	<b>0</b>
		16

This drawing is confidential and must not be reproduced or used without the consent of EXM

Ce dessin est confidentiel et ne doit pas être reproduit ou utilisé sans le consentement de EXM

No.	Revisions	Date	By/Par

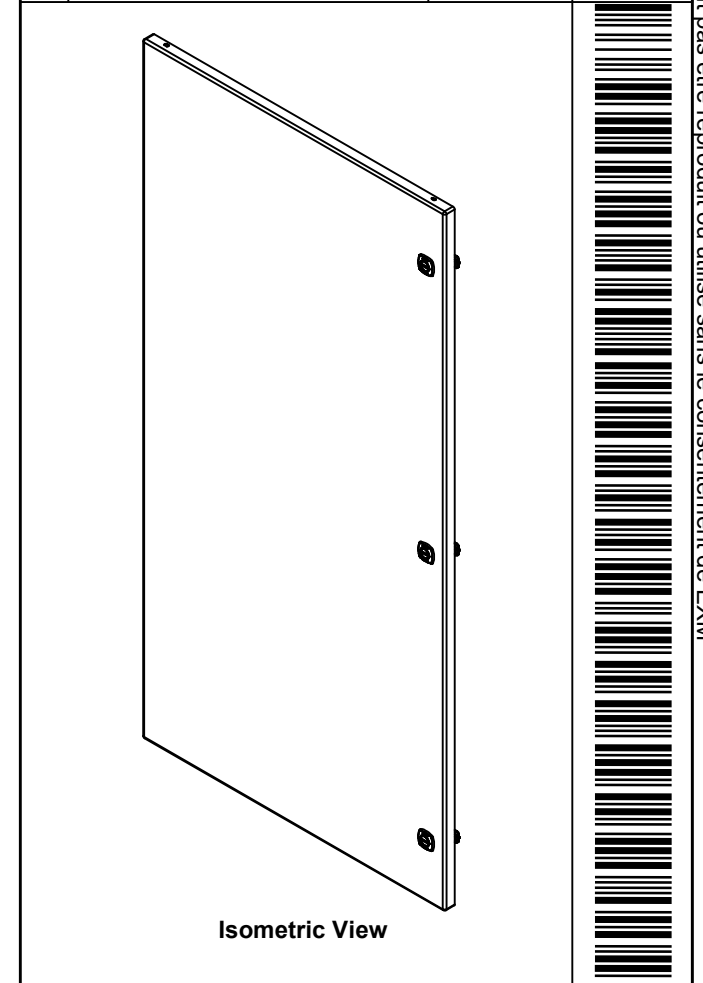

QTY	Part Number	Rev	Description
2	STK-S-00100	0	3.5" x 2" Silver Milar Flexcon Sticker
6	STK-Q-07250	2	M6 x 16mm Collar Nut
2	STK-Q-46020-48	5	5412 ES Vertical Door Stiffener 48"
1	5412ESSP4824086THNOI PI-C	0	5412ESSP 48" x 24" Cover Insulation
1	STK-P-02400S	0	Powder Paint (Asa-61 Grey / Smooth)
6	STK-Q-16070	1	Stud M6 x 18mm Stainless steel
1	5412ESSP4824086THNOI PG	0	5412ESSP 48" x 24" Cover Gasket Part
1	5412ESSP4824086THNOI PC-P	0	5412ESSP 48" x 24" Cover Part
3	880 SCQ4-SLSS6	7	5412 ESS 1/4 Turn Lock
4	STK-A-33016	0	5412 ESS Bended Hinge (Body Part)
Parts List			

Tél: (450) 979-4373  
Fax: (450) 979-4626  
[www.exmweb.com](http://www.exmweb.com)

Flatness  
Aplatissement  
Max 5.0mm

Projection

Customer Client		Date
Drawn By / Dessiné Par: BoxCad: BoxCad		Date: 04-May-23
Material / Matière: 16 Ga Stainless Steel 316 (1.4mm)		
Color / Couleur: Asa-61 Grey	Finish / Fini: Smooth	
Description: 5412ESSP 48" x 24" Cover		Detail Rev.
Part Number / Numéro Pièce: <b>5412ESSP4824086THNOIPC</b>		Rev. 0

This drawing is confidential and must not be reproduced or used without the consent of EXM

Ce dessin est confidentiel et ne doit pas être reproduit ou utilisé sans le consentement de EXM

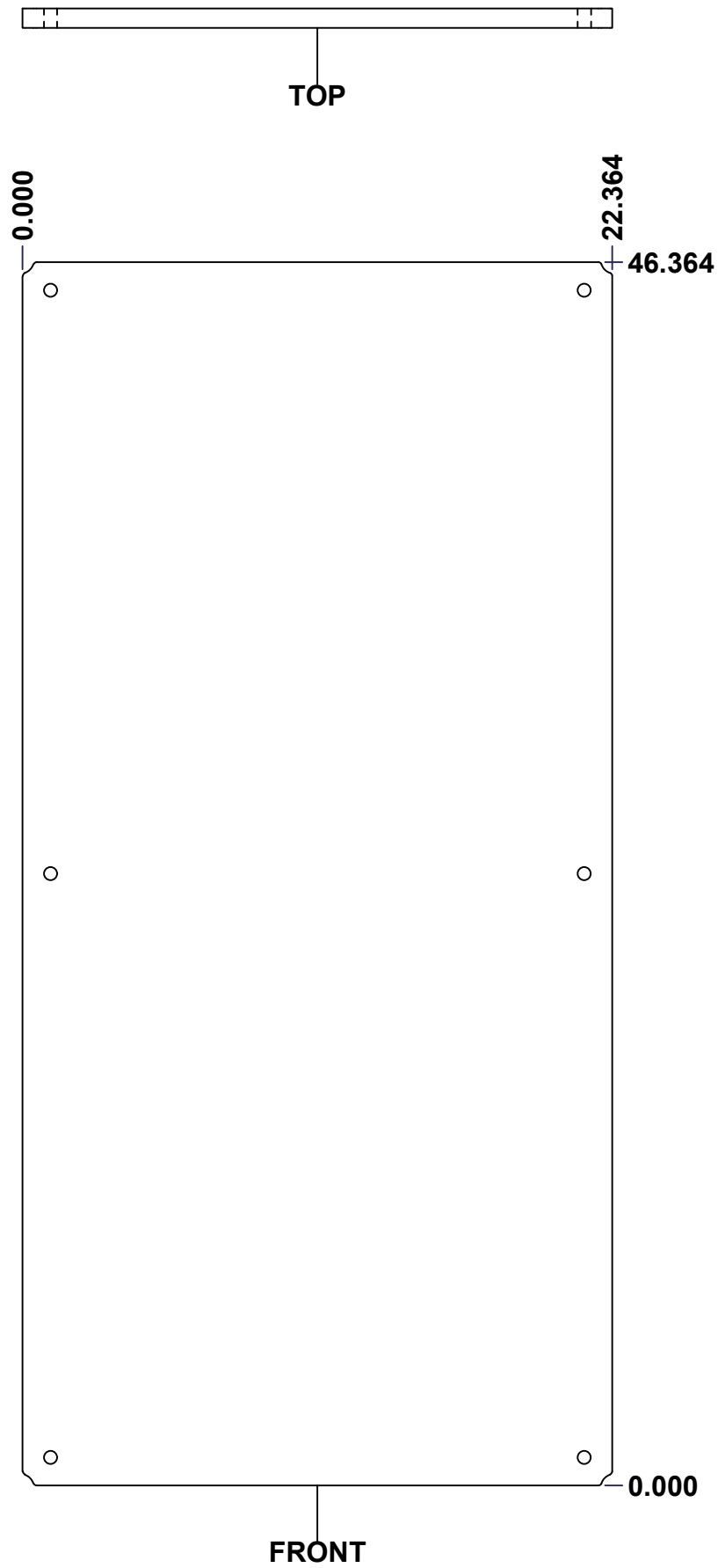

No.	Revisions	Date	By/Par

**Isometric View**

<p>Tél: (450) 979-4373 Fax: (450) 979-4626 <a href="http://www.exmweb.com">www.exmweb.com</a></p>		Flatness Aplatissement Max 3.0mm Projection 
Customer Client	Date	
Drawn By / Dessiné Par: BoxCad: Patrick Deschenes	Date: 23-Jan-07	
Material / Matière: Polyisocyanurate		
Color / Couleur: Aluminum	Finish / Fini: N/A	
Description: 5412ESSP 48" x 24" Back Insulation		Detail Rev.:
Part Number / Numéro Pièce: 5412ESSP4824086THNOIP-B	Rev.:	11

SEE BILL OF MATERIAL ON LAST PAGE 5412ESSP4824086THNOIP-B 0

This drawing is confidential and must not be reproduced or used without the consent of EXM

Ce dessin est confidentiel et ne doit pas être reproduit ou utilisé sans le consentement de EXM

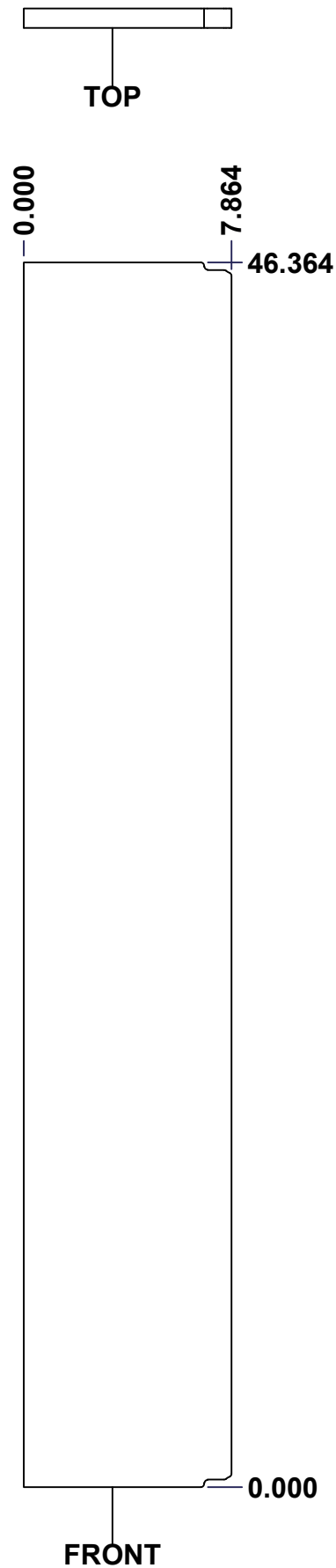

No.	Revisions	Date	By/Par

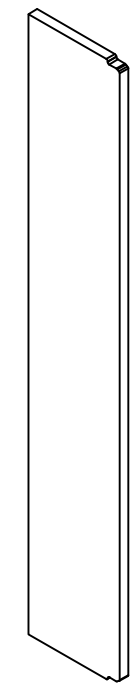

Isometric View

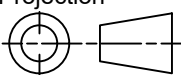

 Tél: (450) 979-4373 Fax: (450) 979-4626 <a href="http://www.exmweb.com">www.exmweb.com</a>		Flatness Aplatissement Max 3.0mm
Projection 		Date 23-Jan-07
Customer Client	Date	
Drawn By Dessiné Par	BoxCad: Patrick Deschenes	Date 23-Jan-07
Material Matière	Polyisocyanurate	
Color Couleur	Aluminum	Finish Fini N/A
Description	Detail Rev.	
5412ESSP 48" x 24" Left Insulation		
Part Number Numéro Pièce	Rev.	12
5412ESSP4824086THNOIPI-LS 0		16

SEE BILL OF MATERIAL ON LAST PAGE

This drawing is confidential and must not be reproduced or used without the consent of EXM

Ce dessin est confidentiel et ne doit pas être reproduit ou utilisé sans le consentement de EXM

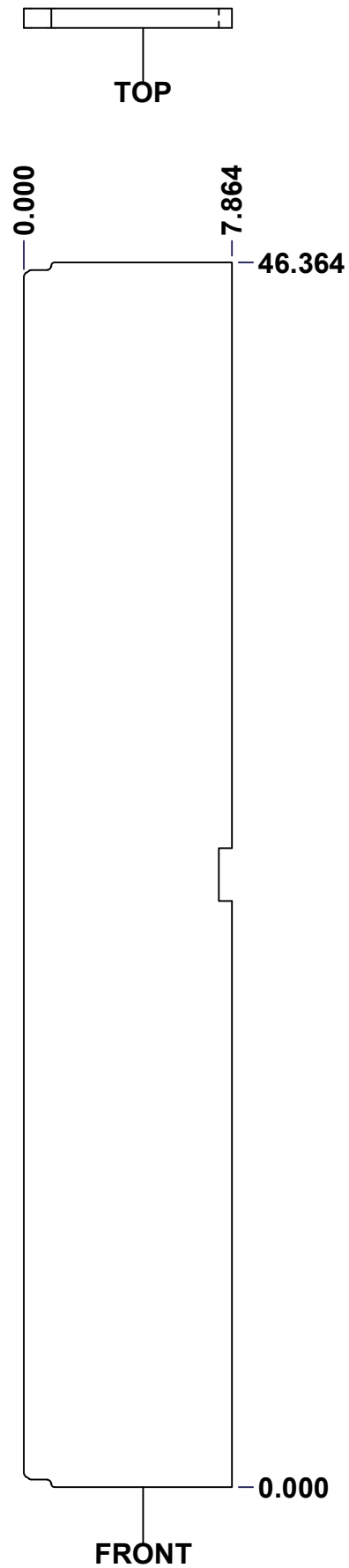

No.	Revisions	Date	By/Par

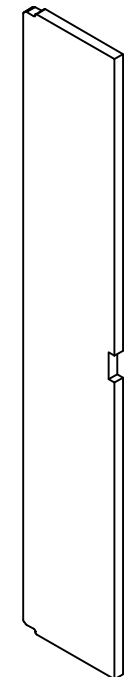

Isometric View

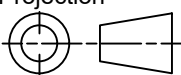

 Tél: (450) 979-4373 Fax: (450) 979-4626 <a href="http://www.exmweb.com">www.exmweb.com</a>		Flatness Aplatissement Max 3.0mm
Projection 		Date 23-Jan-07
Customer Client	Date	
Drawn By Dessiné Par	BoxCad: Patrick Deschenes	Date 23-Jan-07
Material Matière	Polyisocyanurate	
Color Couleur	Aluminum	Finish Fini N/A
Description	Detail Rev.	
5412ESSP 48" x 24" Right Insulation		
Part Number Numéro Pièce	Rev.	13
5412ESSP4824086THNOIP-RS 0		16

SEE BILL OF MATERIAL ON LAST PAGE

This drawing is confidential and must not be reproduced or used without the consent of EXM

Ce dessin est confidentiel et ne doit pas être reproduit ou utilisé sans le consentement de EXM



TOP

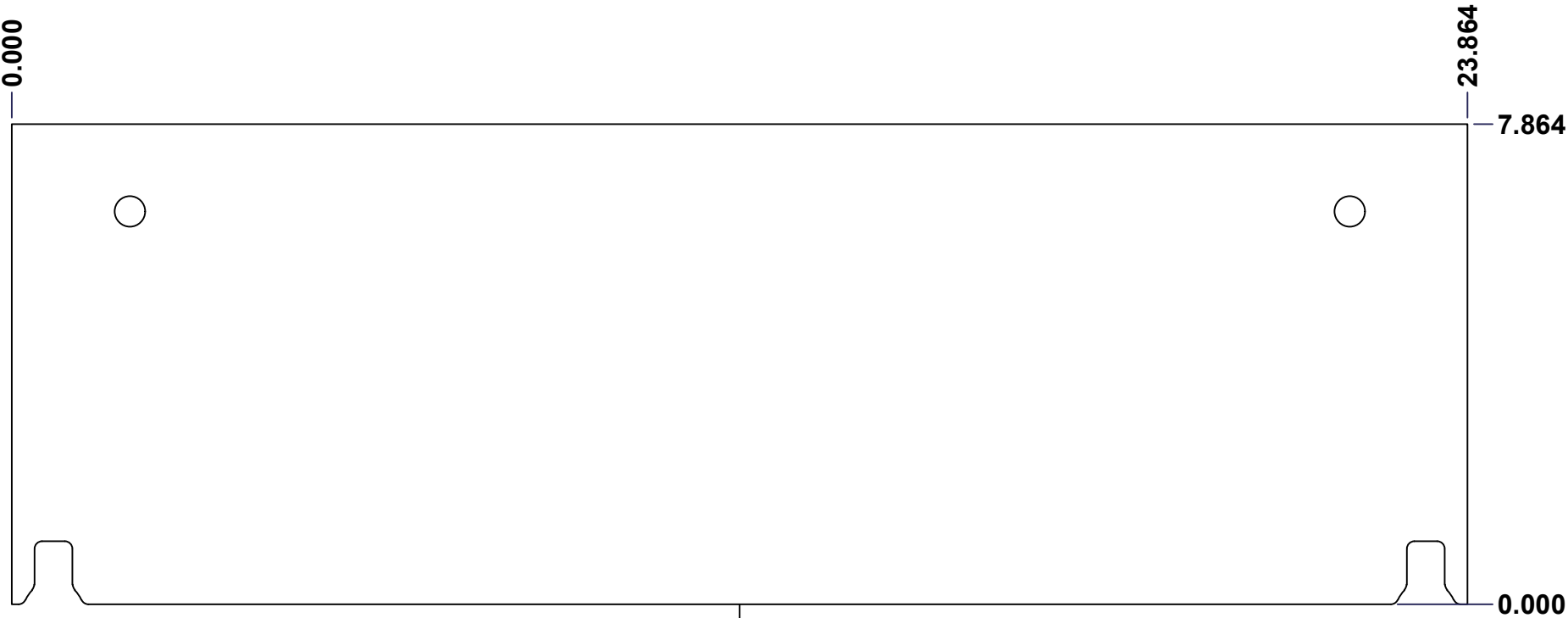

FRONT

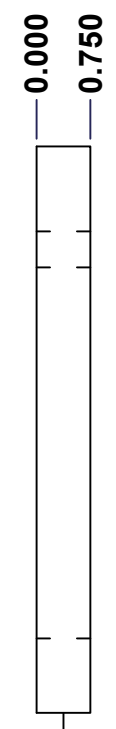

RIGHT

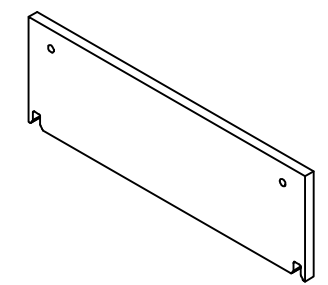

Isometric View

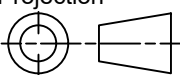

No.	Revisions	Date	By/Par

 Tél: (450) 979-4373 Fax: (450) 979-4626 <a href="http://www.exmweb.com">www.exmweb.com</a>		Flatness Aplatissement Max 3.0mm Projection 
Customer Client	Date	
Drawn By Dessiné Par	BoxCad: Patrick Deschenes	Date 23-Jan-07
Material Matière	Polyisocyanurate	
Color Couleur	Aluminum	Finish Fini N/A
Description	Detail Rev.	
5412ESSP 48" x 24" Top and Bottom Insulation		
Part Number Numéro Pièce	Rev.	14
		16

SEE BILL OF MATERIAL ON LAST PAGE 5412ESSP4824086THNOIPI-TP 0

This drawing is confidential and must not be reproduced or used without the consent of EXM

Ce dessin est confidentiel et ne doit pas être reproduit ou utilisé sans le consentement de EXM



TOP

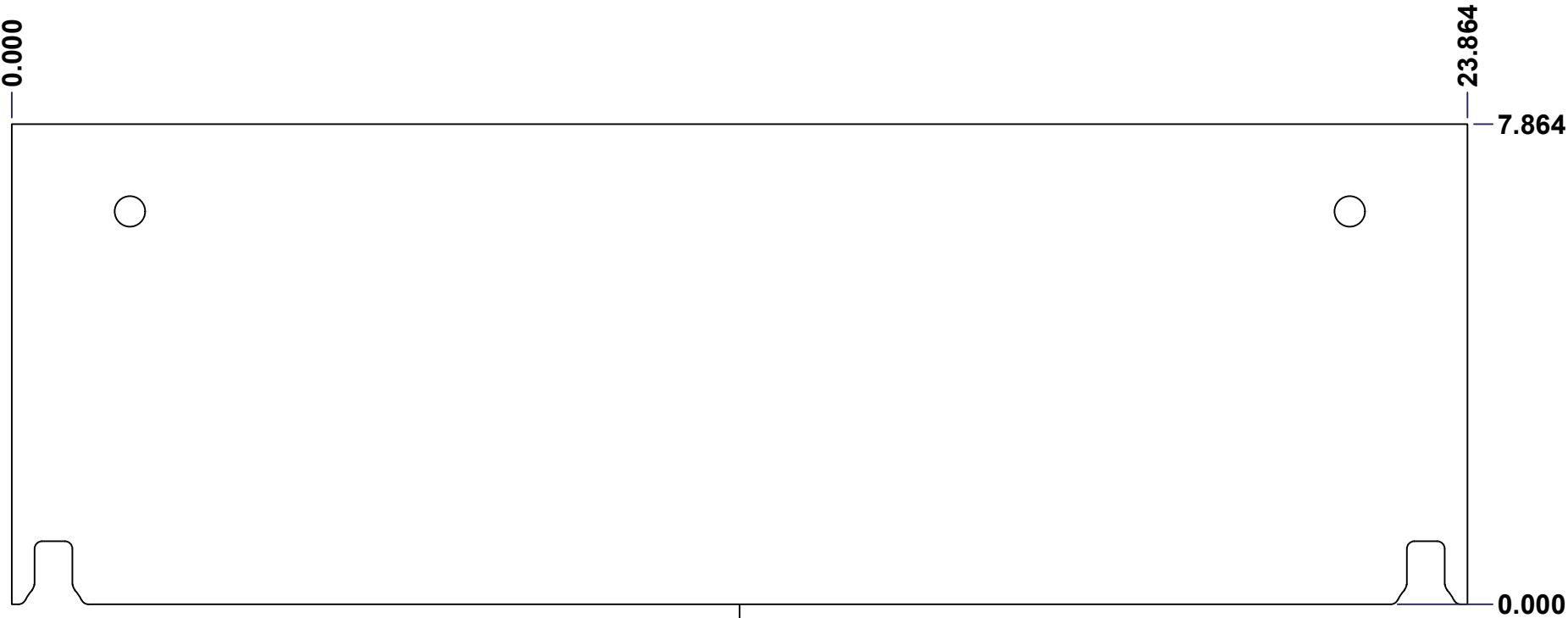

FRONT

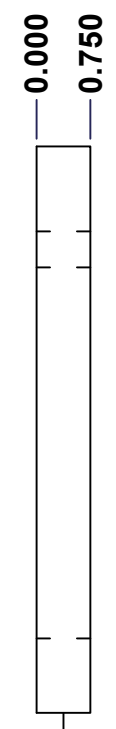

RIGHT

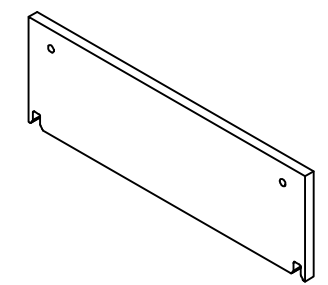

Isometric View

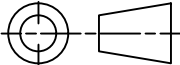

No.	Revisions	Date	By/Par

 Tél: (450) 979-4373 Fax: (450) 979-4626 <a href="http://www.exmweb.com">www.exmweb.com</a>		Flatness Aplatissement Max 3.0mm Projection 
Customer Client	Date	
Drawn By Dessiné Par	BoxCad: Patrick Deschenes	Date 23-Jan-07
Material Matière	Polyisocyanurate	
Color Couleur	Aluminum	Finish Fini N/A
Description	Detail Rev.	
5412ESSP 48" x 24" Top and Bottom Insulation		
Part Number Numéro Pièce	Rev.	15
5412ESSP4824086THNOIPI-BT 0		16

SEE BILL OF MATERIAL ON LAST PAGE

This drawing is confidential and must not be reproduced or used without the consent of EXM

Ce dessin est confidentiel et ne doit pas être reproduit ou utilisé sans le consentement de EXM

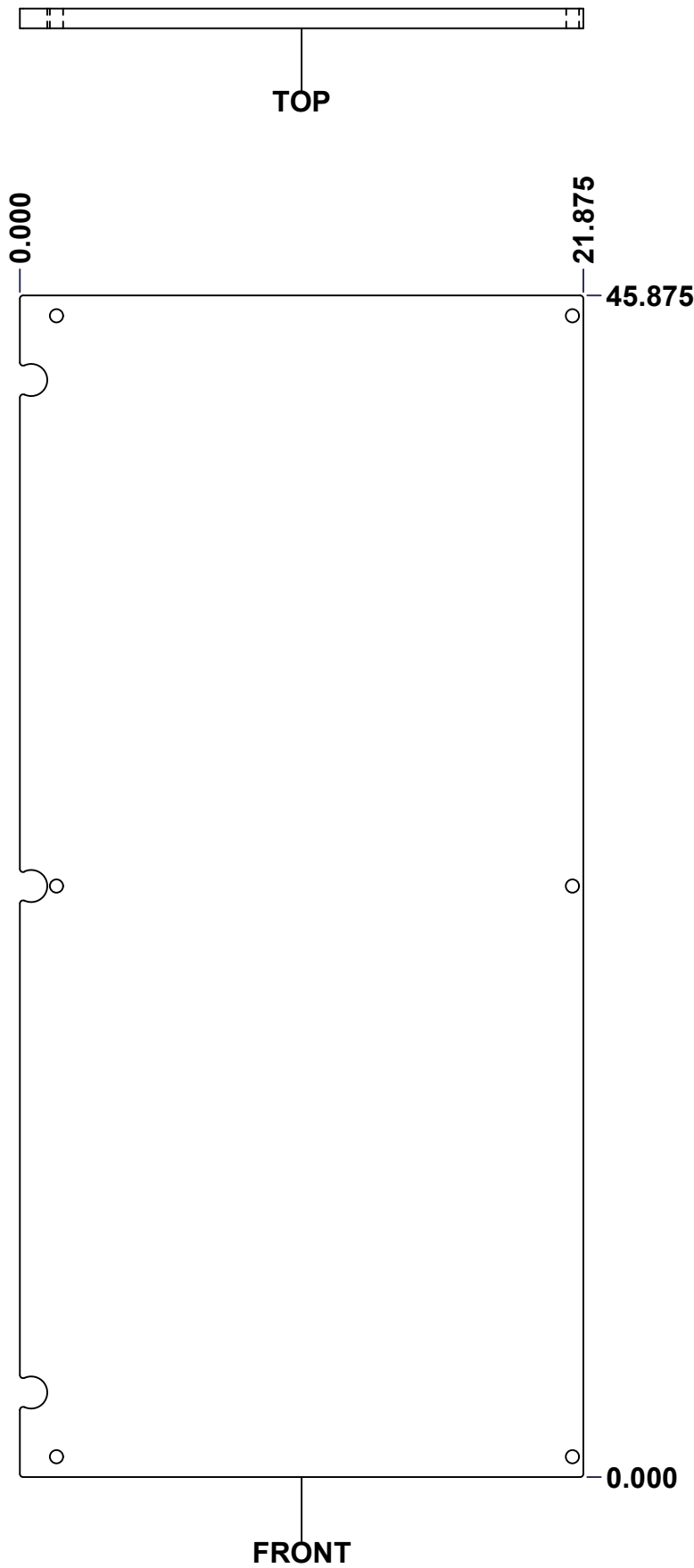

No.	Revisions	Date	By/Par

**Isometric View**

<p>Tél: (450) 979-4373 Fax: (450) 979-4626 <a href="http://www.exmweb.com">www.exmweb.com</a></p>		Flatness Aplatissement
		Max 3.0mm
Projection		
Customer Client	Date	
Drawn By Dessiné Par	BoxCad: Patrick Deschenes	Date 23-Jan-07
Material Matière Polyisocyanurate		
Color Couleur	Aluminum	Finish Fini N/A
Description		Detail Rev.
5412ESSP 48" x 24" Cover Insulation		
Part Number Numéro Pièce	Rev.	16
SEE BILL OF MATERIAL ON LAST PAGE		5412ESSP4824086THNOIP-C 0