

This drawing is confidential and must not be reproduced or used without the consent of EXM

Ce dessin est confidentiel et ne doit pas être reproduit ou utilisé sans le consentement de EXM



TOP



BACK



BOTTOM

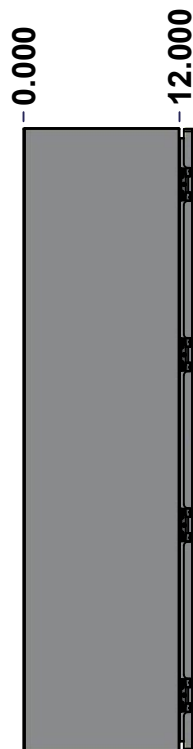

LEFT

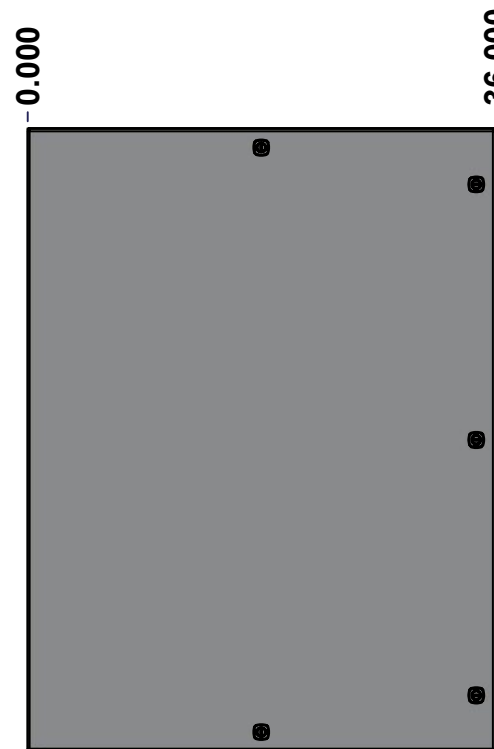

FRONT

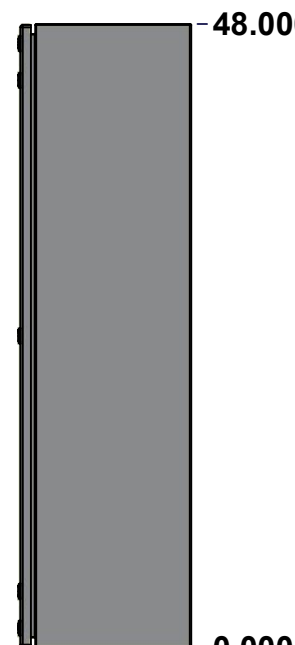

RIGHT

No.	Revisions	Date	By/Par

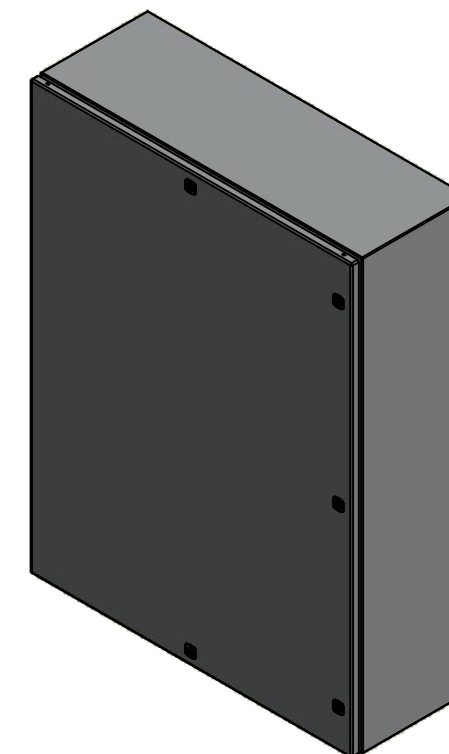

Isometric View



Tél: (450) 979-4373  
 Fax: (450) 979-4626  
[www.exmweb.com](http://www.exmweb.com)

Flatness  
Aplatissement

Max 3.0mm

Projection



Customer Client	Date
Drawn By / Dessiné Par: BoxCad: BoxCad	Date: 7/11/2022
Material / Matière: 14 Ga Stainless Steel 316 (1.7mm)	
Color / Couleur: Asa-61 Grey	Finish / Fini: Smooth
Description: 5412ESSP 48" x 36" x 12" Assembly	Detail Rev.
Part Number / Numéro Pièce: 5412ESSP4836126	Rev. 1
	9

SEE BILL OF MATERIAL ON LAST PAGE

This drawing is confidential and must not be reproduced or used without the consent of EXM

Ce dessin est confidentiel et ne doit pas être reproduit ou utilisé sans le consentement de EXM

NOTE	
ITEM	DESCRIPTION
1	NEMA 4X Enclosure
2	C/W Standard ground studs on box and cover
3	C/W Standard door stiffener
4	C/W Standard inner panel (Included)
5	C/W Standard inner panel mounting studs
6	C/W Special locks sold separately (Installed)

No.	Revisions	Date	By/Par

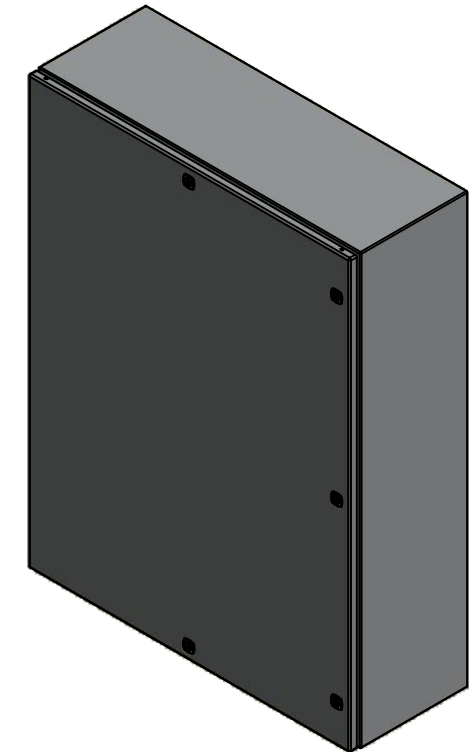

Isometric View



	Tél: (450) 979-4373 Fax: (450) 979-4626 <a href="http://www.exmweb.com">www.exmweb.com</a>	Flatness
		Aplatissement
		Max 3.0mm
		Projection

Customer Client	Date
Drawn By / Dessiné Par: BoxCad: BoxCad	Date: 7/11/2022

Material Matière: 14 Ga Stainless Steel 316 (1.7mm)

Color Couleur: Asa-61 Grey	Finish Fini: Smooth
----------------------------	---------------------

Description: 5412ESSP 48" x 36" x 12" Assembly

Part Number / Numéro Pièce: <b>5412ESSP4836126</b>	Rev. 0	2	9
--	--------	---	---

PACKING		
ITEM	QTY	DESCRIPTION
Cardboard sleeve	2	Top and Bottom
Cardboard strip	2	Between back of enclosure and inner panel
Plastic bag	1	To protect cover surface and inside gasket
Cardboard corner	4	To reinforced for the plastic strap tightening
Plastic strap - Black	2	To Squeeze the 2 cardboard sleeve together
Packaging label	3	White label with PN
Plastic strap- Green	2	To secure the enclosure to the wood pallet
Wood Pallet	1	2" deeper and 3" larger than enclosure size

Qty	Part Number	Rev	Description
1	880 PP	6	Self Adhesive Print Pocket
1	STK-K-01800	5	5412 ES Accessory Kit
1	881 SP4836G	0	881 SP - Inner Panel
1	5412ESSP4836126C	0	5412ESSP 48" x 36" Cover
8	STK-Q-07310	2	Flange Lock Nut M8
8	STK-Q-07610	8	M8 Plastic Spacer 22.2mm
1	5412ESSP4836126B	0	5412ESSP 48" x 36" x 12" Body
4	STK-Q-04051-07	8	M6 x 7mm Stainless Steel Hexagon Socket Head Machine Screw with Nyseal
Parts List			

This drawing is confidential and must not be reproduced or used without the consent of EXM

Ce dessin est confidentiel et ne doit pas être reproduit ou utilisé sans le consentement de EXM



TOP



BACK

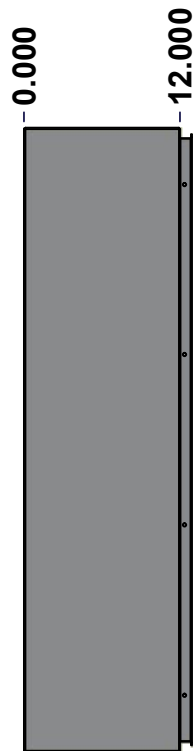

LEFT

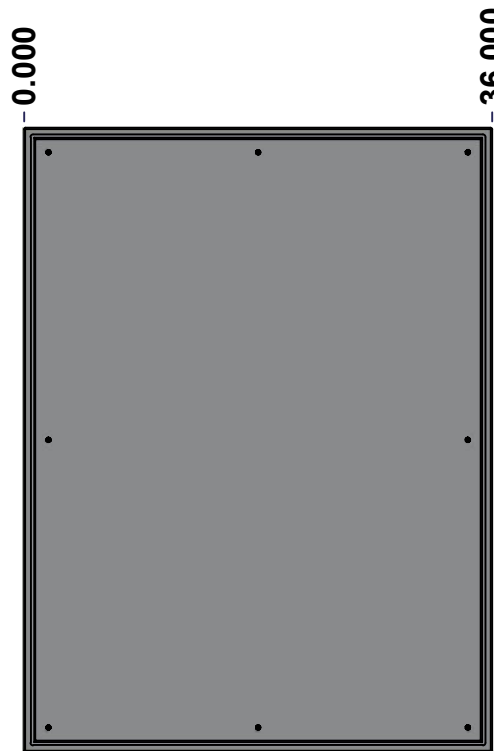

FRONT

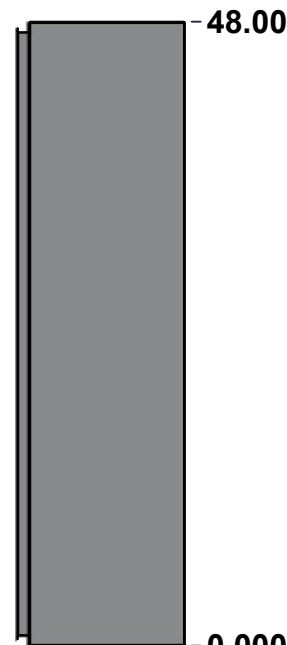

RIGHT



BOTTOM

No.	Revisions	Date	By/Par

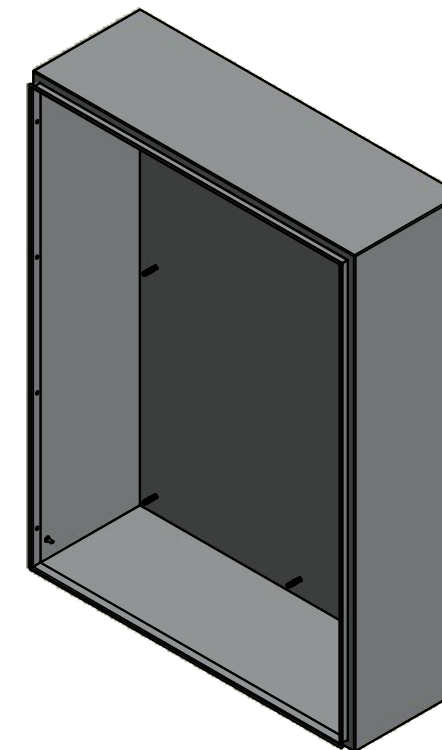

Isometric View



Tél: (450) 979-4373  
 Fax: (450) 979-4626  
[www.exmweb.com](http://www.exmweb.com)

Flatness  
Aplatissement

Max 3.0mm

Projection



Customer Client	Date
Drawn By / Dessiné Par: BoxCad: BoxCad	Date: 7/11/2022
Material / Matière: 14 Ga Stainless Steel 316 (1.7mm)	
Color / Couleur: Asa-61 Grey	Finish / Fini: Smooth
Description: 5412ESSP 48" x 36" x 12" Body	Detail Rev.
Part Number / Numéro Pièce: 5412ESSP4836126B	Rev. 3
	0

SEE BILL OF MATERIAL ON LAST PAGE

This drawing is confidential and must not be reproduced or used without the consent of EXM

Ce dessin est confidentiel et ne doit pas être reproduit ou utilisé sans le consentement de EXM

<b>STANDARD FEATURES ARE NOT LISTED IN THIS HOLE TABLE</b>			
<b>HOLE TABLE - LEFT VIEW (CUSTOM FEATURE ONLY)</b>			
CUT-OUT	XDIM	YDIM	DESCRIPTION
1	10.500	2.000	GND STUD M6 x 16mm (Inside)

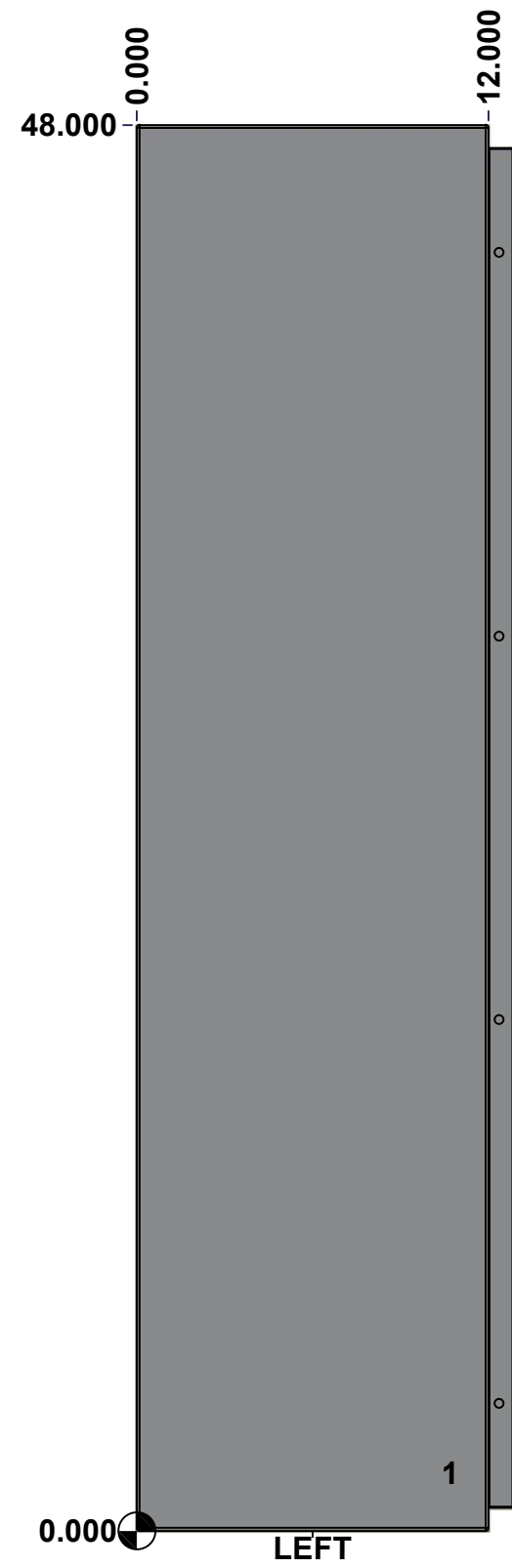

	Description	Status	
	5412ESSP 48" x 36" x 12" Body	(NULL)	
	Part Number Numéro Pièce	Rev.	
	<b>5412ESSP4836126B</b>	<b>0</b>	4/9

This drawing is confidential and must not be reproduced or used without the consent of EXM

Ce dessin est confidentiel et ne doit pas être reproduit ou utilisé sans le consentement de EXM

**STANDARD FEATURES ARE NOT LISTED IN THIS HOLE TABLE**

**HOLE TABLE - BACK VIEW (CUSTOM FEATURE ONLY)**

CUT-OUT	XDIM	YDIM	DESCRIPTION
1	1.875	1.875	IP STUD M8 x 35mm (Inside)
2	1.875	46.125	IP STUD M8 x 35mm (Inside)
3	34.125	46.125	IP STUD M8 x 35mm (Inside)
4	34.125	1.875	IP STUD M8 x 35mm (Inside)
5	1.875	24.000	IP STUD M8 x 35mm (Inside)
6	34.125	24.000	IP STUD M8 x 35mm (Inside)
7	18.000	1.875	IP STUD M8 x 35mm (Inside)
8	18.000	46.125	IP STUD M8 x 35mm (Inside)
-----			
9	35.250	0.750	RND Ø0.390
10	35.250	47.250	RND Ø0.390
11	0.750	47.250	RND Ø0.390
12	0.750	0.750	RND Ø0.390

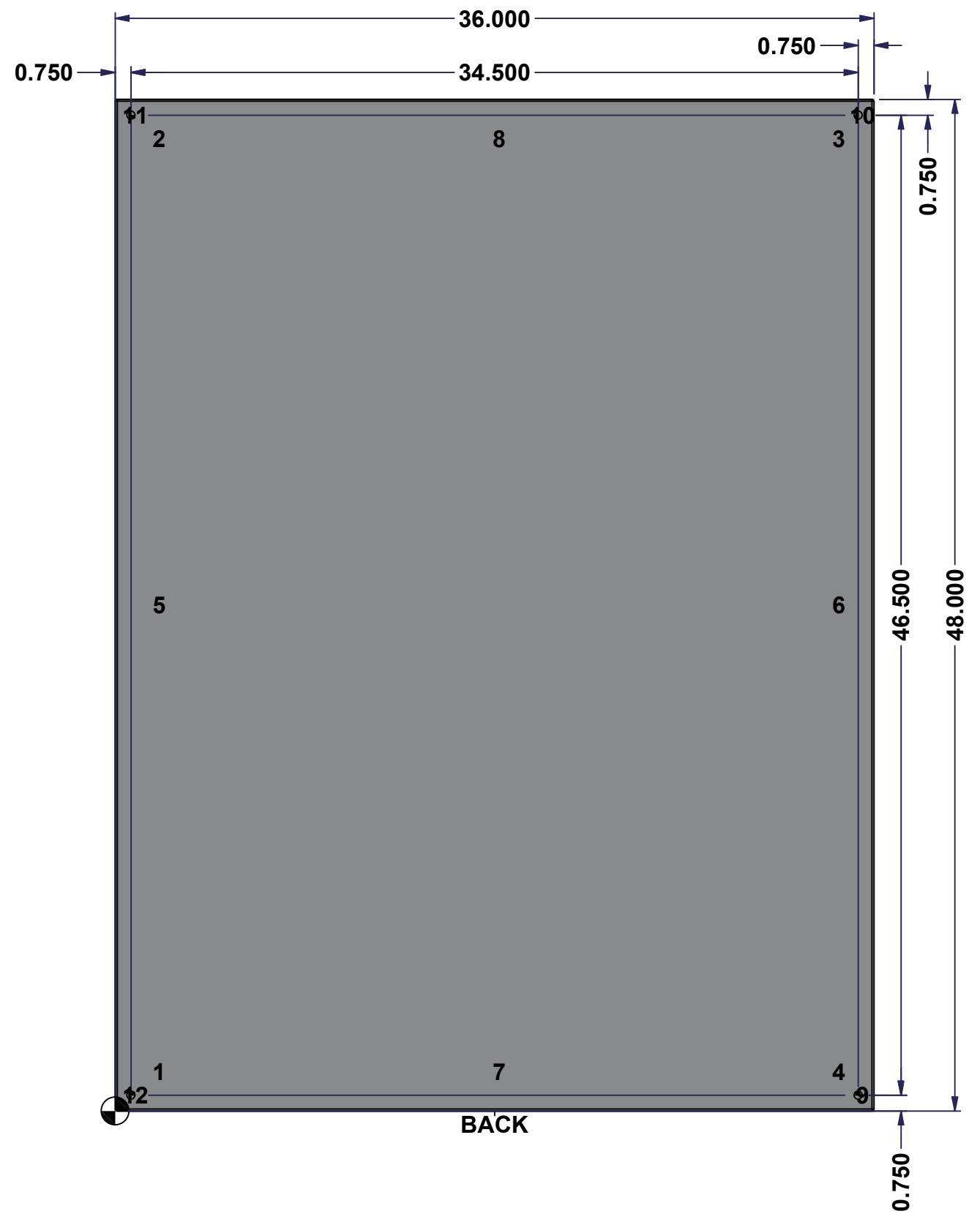

	Description	Status	
	5412ESSP 48" x 36" x 12" Body	(NULL)	
	Part Number Numéro Pièce	Rev.	
	<b>5412ESSP4836126B</b>	<b>0</b>	5 9

This drawing is confidential and must not be reproduced or used without the consent of EXM

Ce dessin est confidentiel et ne doit pas être reproduit ou utilisé sans le consentement de EXM

No.	Revisions	Date	By/Par

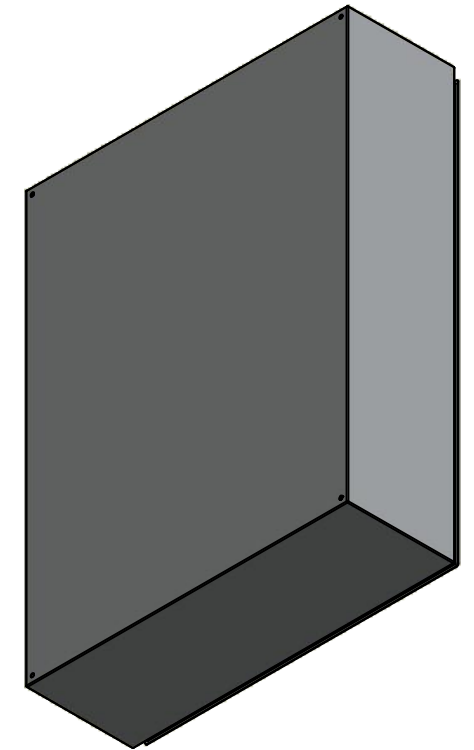

Isometric View



 Tél: (450) 979-4373 Fax: (450) 979-4626 <a href="http://www.exmweb.com">www.exmweb.com</a>	Flatness Aplatissement	Max 3.0mm
	Projection	
Customer Client	Date	
Drawn By Dessiné Par	BoxCad: BoxCad	Date 7/11/2022
Material Matière	14 Ga Stainless Steel 316 (1.7mm)	
Color Couleur	Asa-61 Grey	Finish Fini Smooth
Description	Detail Rev.	
5412ESSP 48" x 36" x 12" Body		
Part Number Numéro Pièce	Rev.	6
<b>5412ESSP4836126B</b>	<b>0</b>	9

Qty	Part Number	Rev	Description
1	STK-Q-16085	0	Ground Stud M6 x 16mm Stainless Steel
1	STK-P-02400S	0	Powder Paint (Asa-61 Grey / Smooth)
8	STK-Q-16020	1	Stud M8 x 35mm Stainless Steel
1	5412ESSP4836126B-P	0	5412ESSP 48" x 36" x 12" Body Part
Parts List			

This drawing is confidential and must not be reproduced or used without the consent of EXM

Ce dessin est confidentiel et ne doit pas être reproduit ou utilisé sans le consentement de EXM

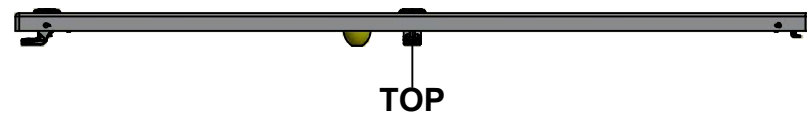

TOP

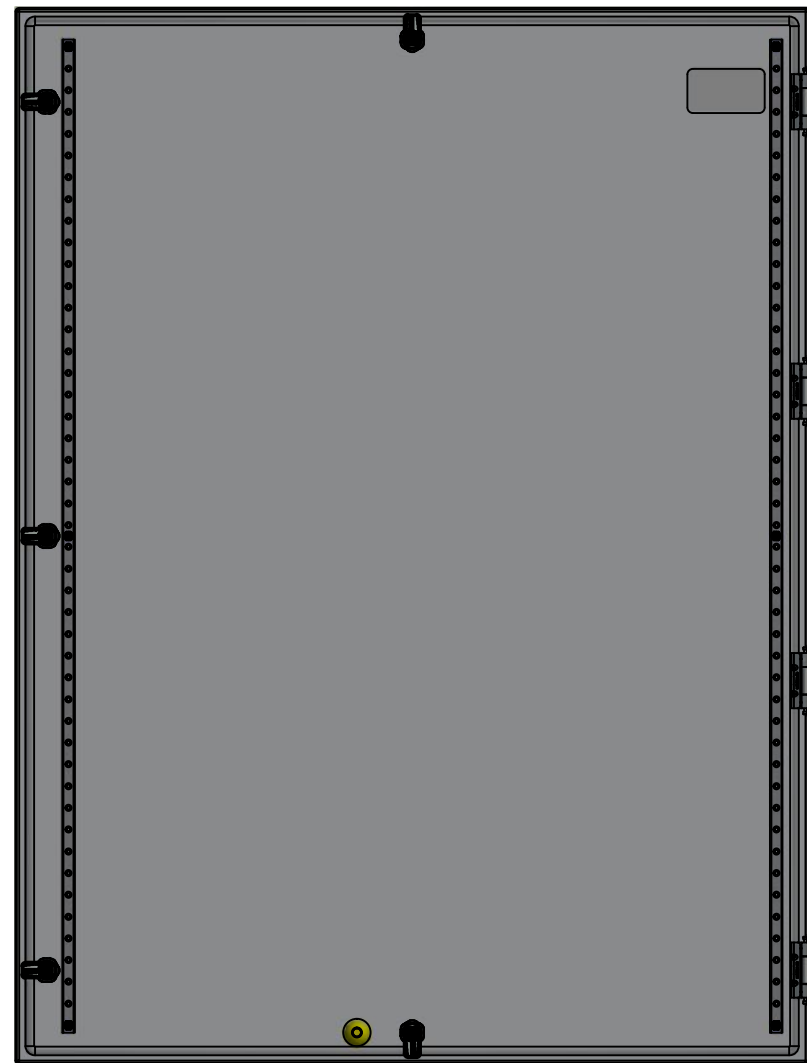

BACK



BOTTOM

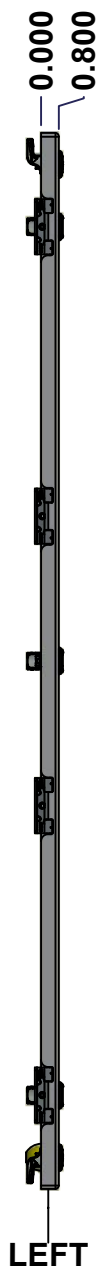

LEFT

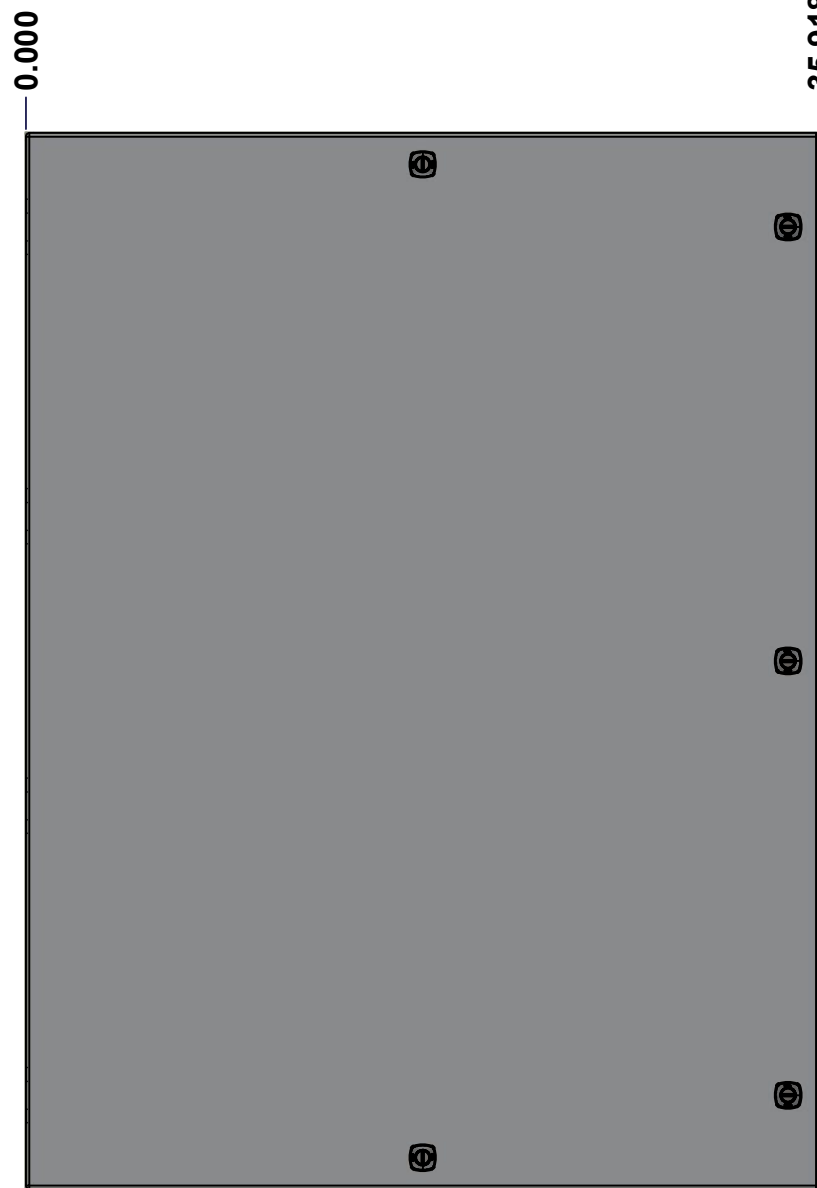

FRONT

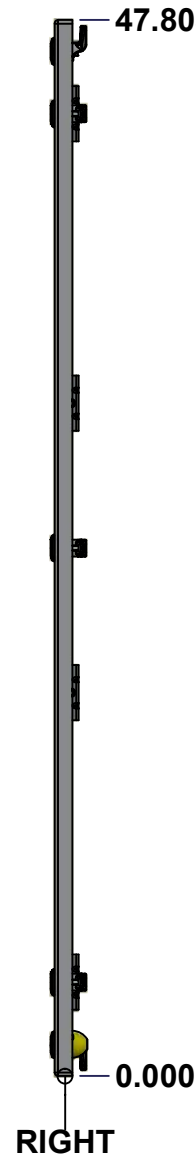

RIGHT

No.	Revisions	Date	By/Par

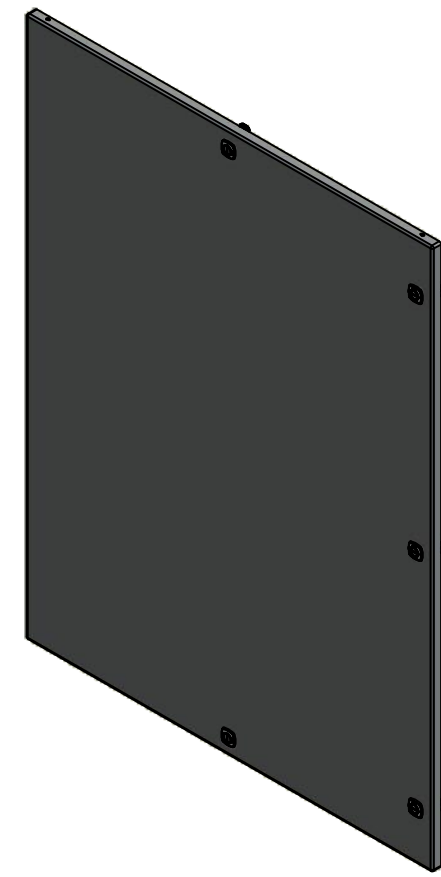

Isometric View



Tél: (450) 979-4373  
 Fax: (450) 979-4626  
[www.exmweb.com](http://www.exmweb.com)

Flatness  
Aplatissement  
Max 3.0mm  
Projection

Customer Client	Date
Drawn By Dessiné Par BoxCad: BoxCad	Date 7/11/2022
Material Matière 14 Ga Stainless Steel 316 (1.7mm)	
Color Couleur Asa-61 Grey	Finish Fini Smooth
Description 5412ESSP 48" x 36" Cover	Detail Rev.
Part Number Numéro Pièce <b>5412ESSP4836126C</b>	Rev. 7 0

SEE BILL OF MATERIAL ON LAST PAGE

This drawing is confidential and must not be reproduced or used without the consent of EXM

Ce dessin est confidentiel et ne doit pas être reproduit ou utilisé sans le consentement de EXM

**STANDARD FEATURES ARE NOT LISTED IN THIS HOLE TABLE**

**HOLE TABLE - FRONT VIEW (CUSTOM FEATURE ONLY)**

CUT-OUT	XDIM	YDIM	DESCRIPTION
1	1.486	1.756	STUD M6 x 18mm (Inside)
2	1.486	46.047	STUD M6 x 18mm (Inside)
3	33.517	46.047	STUD M6 x 18mm (Inside)
4	33.517	1.756	STUD M6 x 18mm (Inside)
5	1.486	23.902	STUD M6 x 18mm (Inside)
6	33.517	23.902	STUD M6 x 18mm (Inside)
7	20.459	1.435	STUD M6 x 18mm (Inside)
-----			
8	3.750	44.053	LABEL_EXM (Inside)
9	34.494	43.553	LOCK 880 SCQ4-SLSS6 @ 0.0°
10	34.494	23.902	LOCK 880 SCQ4-SLSS6 @ 0.0°
11	34.494	4.250	LOCK 880 SCQ4-SLSS6 @ 0.0°
12	17.959	46.379	LOCK 880 SCQ4-SLSS6 @ 90.0°
13	17.959	1.424	LOCK 880 SCQ4-SLSS6 @ 270.0°

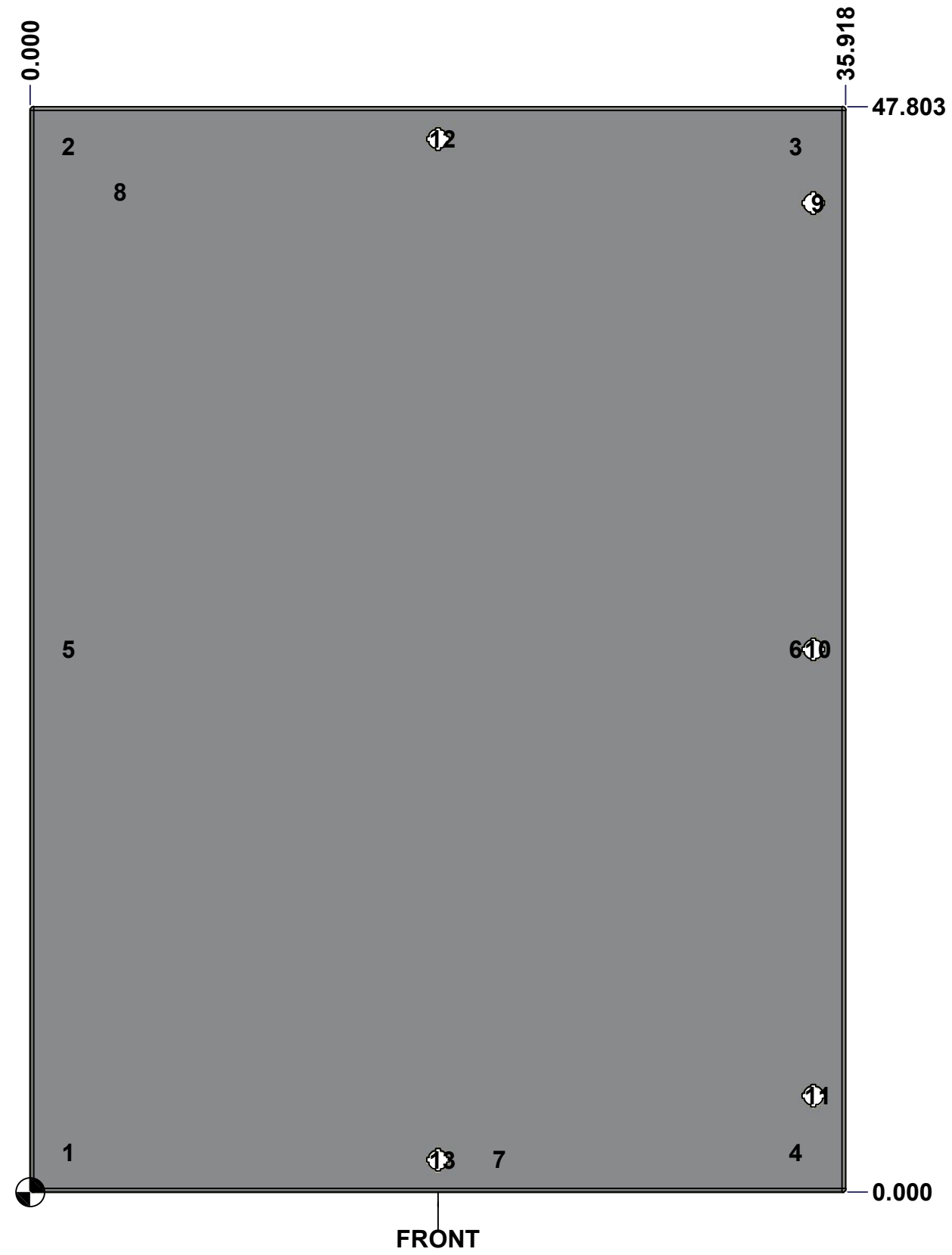

	Description	Status
	5412ESSP 48" x 36" Cover	(NULL)
Part Number Numéro Pièce <b>5412ESSP4836126C</b>	Rev.	8
	<b>0</b>	9



This drawing is confidential and must not be reproduced or used without the consent of EXM

Ce dessin est confidentiel et ne doit pas être reproduit ou utilisé sans le consentement de EXM

No.	Revisions	Date	By/Par

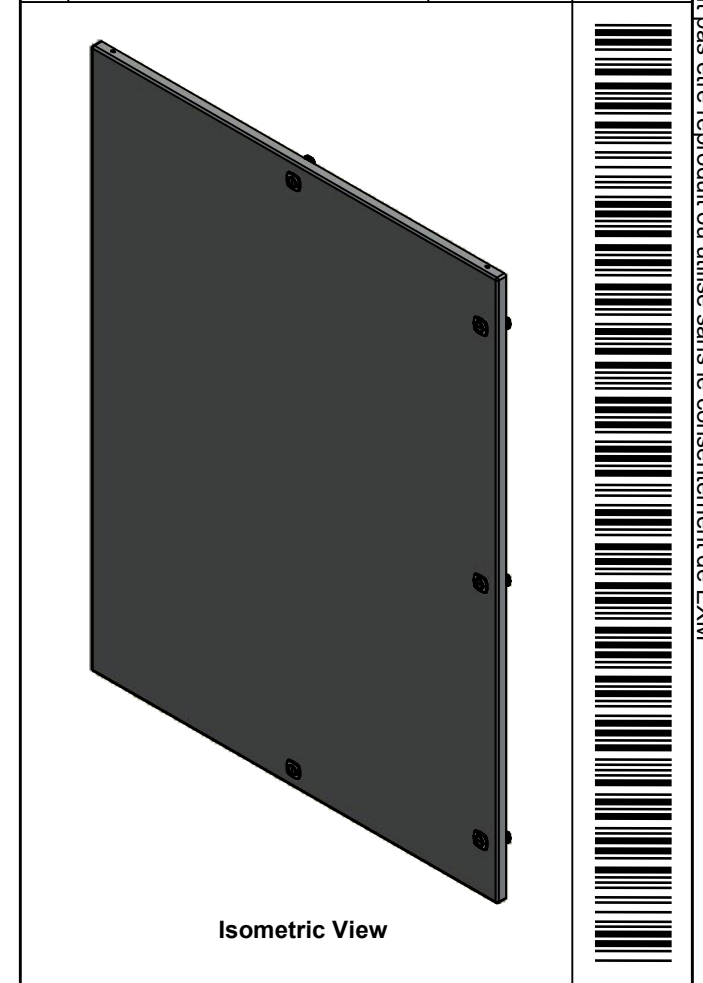

 Tél: (450) 979-4373  
 Fax: (450) 979-4626  
[www.exmweb.com](http://www.exmweb.com)

Flatness  
 Aplatissement  
 Max 3.0mm  
 Projection  

1	STK-S-00100	0	3.5" x 2" Silver Milar Flexcon Sticker
1	STK-P-02400S	0	Powder Paint (Asa-61 Grey / Smooth)
1	STK-Q-46515	3	5412 ES Door Support with Brass Insert
2	STK-Q-46020-48	5	5412 ES Vertical Door Stiffener 48"
7	STK-Q-16070	1	Stud M6 x 18mm Stainless steel
1	5412ESSP4836126G	0	5412ESSP 48" x 36" Cover Gasket Part
1	5412ESSP4836126C-P	0	5412ESSP 48" x 36" Cover Part
4	STK-A-33016	0	5412 ESS Bended Hinge (Body Part)
5	880 SCQ4-SLSS6	7	5412 ESS 1/4 Turn Lock
6	STK-Q-07220	1	M6 Nylon Insert Lock Nut
Qty	Part Name	Rev	Description
Parts List			

Customer Client	Date
Drawn By Dessiné Par BoxCad: BoxCad	Date 7/11/2022
Material Matière	14 Ga Stainless Steel 316 (1.7mm)
Color Couleur	Asa-61 Grey
Finish Fini	Smooth
Description	Detail Rev.
5412ESSP 48" x 36" Cover	
Part Number Numéro Pièce	Rev. 9
<b>5412ESSP4836126C</b>	<b>0</b> 9

This drawing is confidential and must not be reproduced or used without the consent of EXM

Ce dessin est confidentiel et ne doit pas être reproduit ou utilisé sans le consentement de EXM

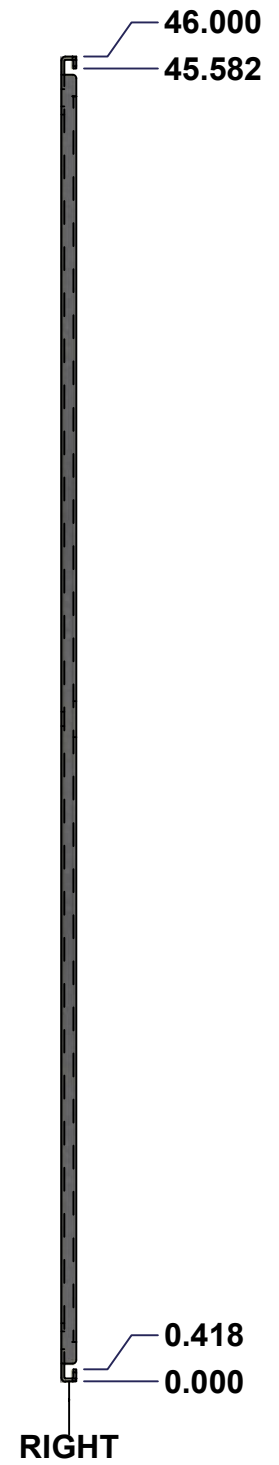
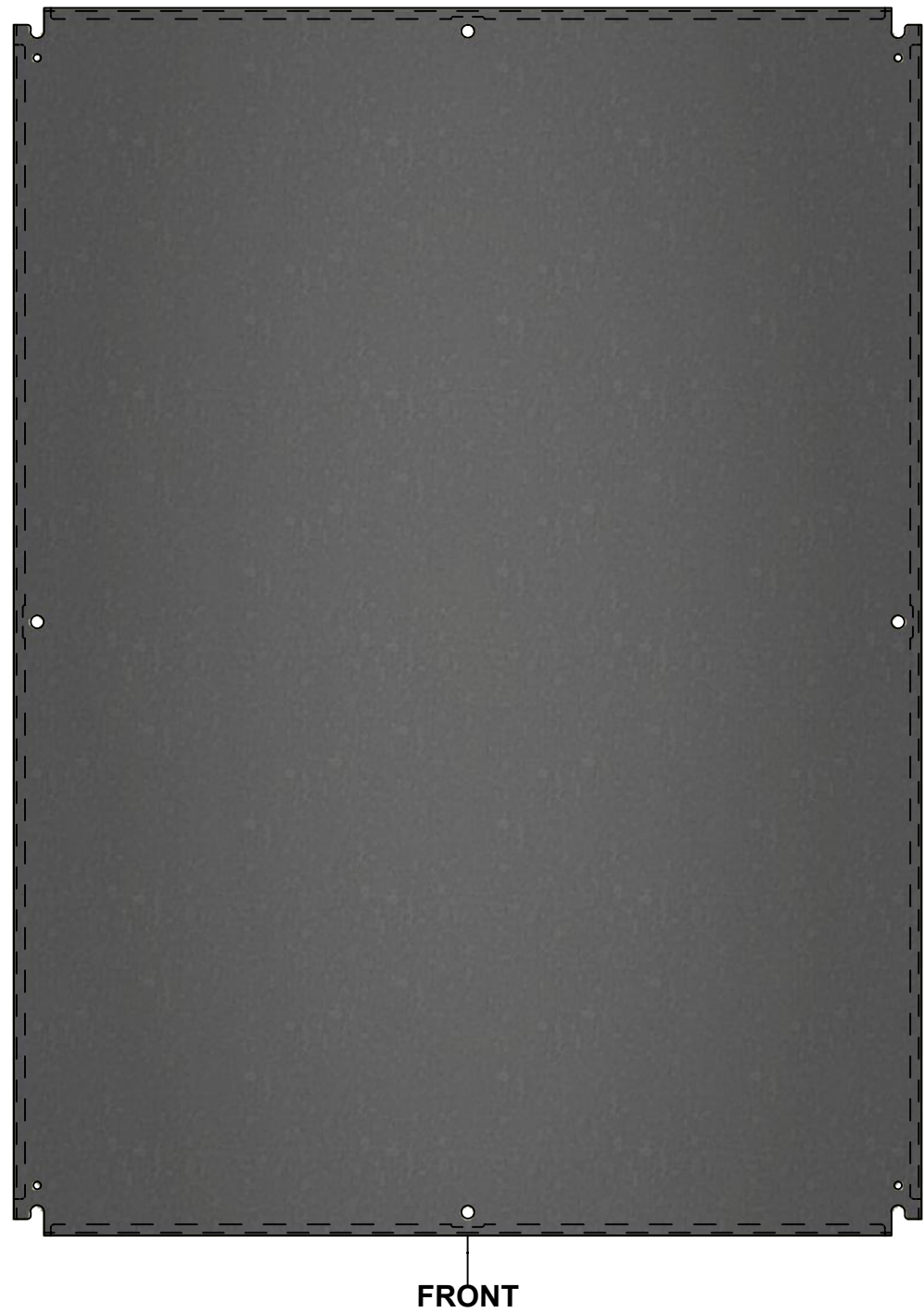
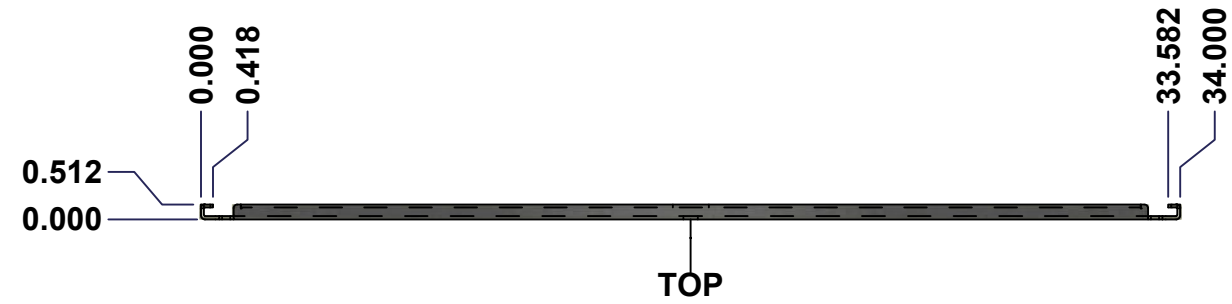

No.	Revisions	Date	By/Par

Isometric View

<p>Tél: (450) 979-4373 Fax: (450) 979-4626 www.exmweb.com</p>	Flatness Aplatissement
	Max 3.0mm
Projection	
Customer Client	Date
Drawn By Dessiné Par BoxCad	Date 1/23/2007
Material Matière	See Part List
Color Couleur	See Part List
Finish Fini	See Part List
Description	Detail Rev.
881 SP - Inner Panel	
Part Number Numéro Pièce	Rev. 1
<b>881 SP4836G</b>	<b>0</b> 2

Qty	Part Number	Rev	Description	Material	Color	Finish
1	881 SP4836G-P	0	881 SP - Inner Panel Part	12 Ga Galvanized	Unpainted	Galvanized

Parts List

This drawing is confidential and must not be reproduced or used without the consent of EXM

Ce dessin est confidentiel et ne doit pas être reproduit ou utilisé sans le consentement de EXM

Table 1			FRONT VIEW
CUT-OUT	XDIM	YDIM	DESCRIPTION
1	17.000	0.875	MTG STUD HOLE (RND Ø0.500)
2	0.875	23.000	MTG STUD HOLE (RND Ø0.500)
3	33.125	23.000	MTG STUD HOLE (RND Ø0.500)
4	17.000	45.125	MTG STUD HOLE (RND Ø0.500)
5	0.875	1.875	GROUND HOLE (RND Ø0.290)
6	33.125	1.875	GROUND HOLE (RND Ø0.290)
7	0.875	44.125	GROUND HOLE (RND Ø0.290)
8	33.125	44.125	GROUND HOLE (RND Ø0.290)

All knockouts are actual size / Les disques défonçables sont grandeur réel

No.	Revisions	Date	By/Par

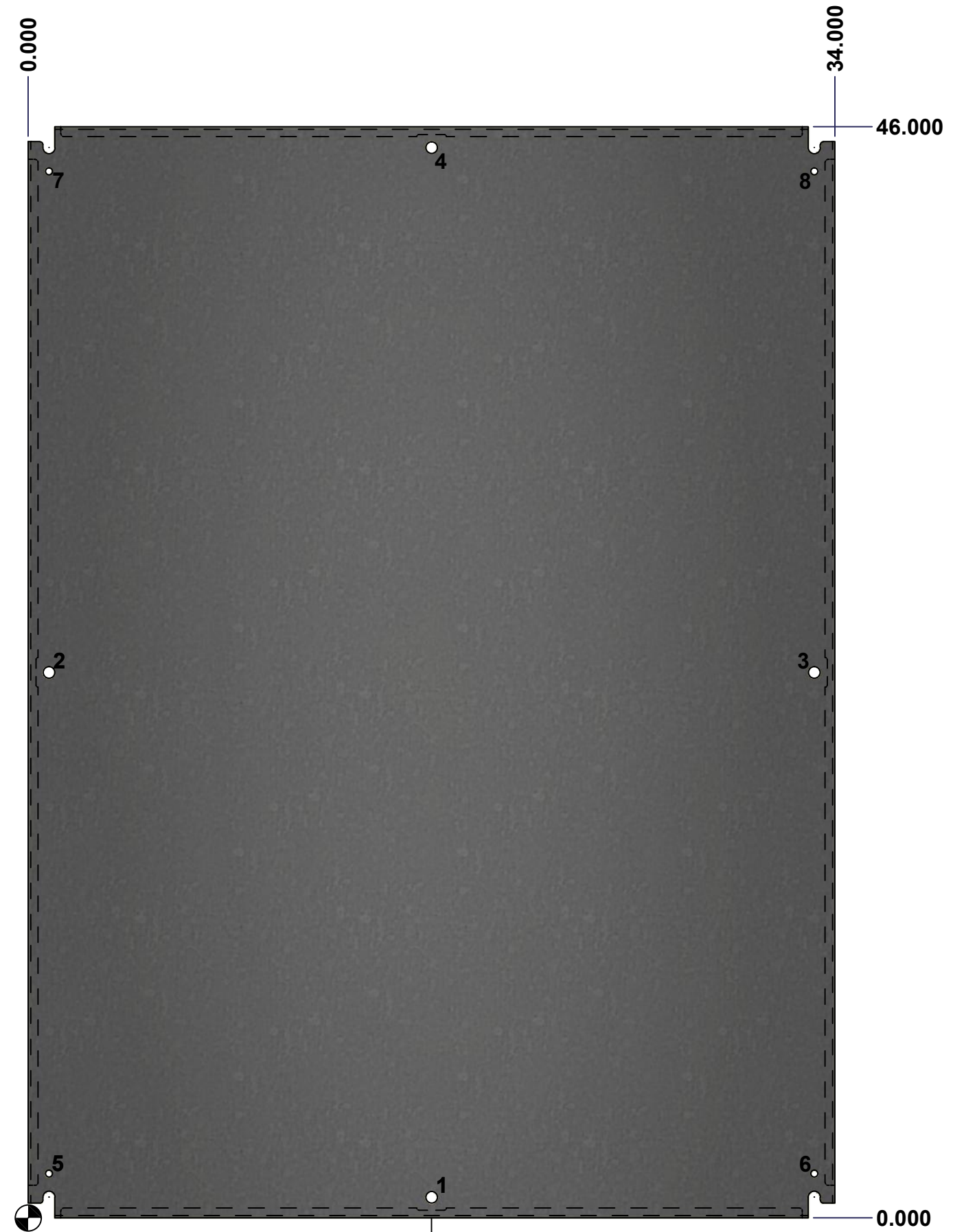

FRONT



Isometric View



	Tél: (450) 979-4373 Fax: (450) 979-4626 www.exmweb.com	Flatness	
		Aplatissement	
		Max 3.0mm	
		Projection	
Customer Client		Date	
Drawn By / Dessiné Par	BoxCad	Date	1/23/2007
Material / Matière	See Part List		
Color / Couleur	See Part List	Finish / Fini	See Part List
Description	881 SP - Inner Panel		Detail Rev.
Part Number / Numéro Pièce	881 SP4836G		Rev. 2
			0