

This drawing is confidential and must not be reproduced or used without the consent of EXM

Ce dessin est confidentiel et ne doit pas être reproduit ou utilisé sans le consentement de EXM

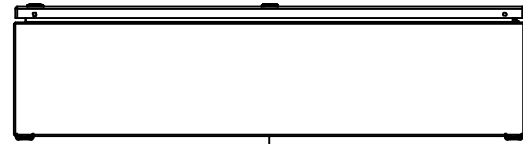

TOP

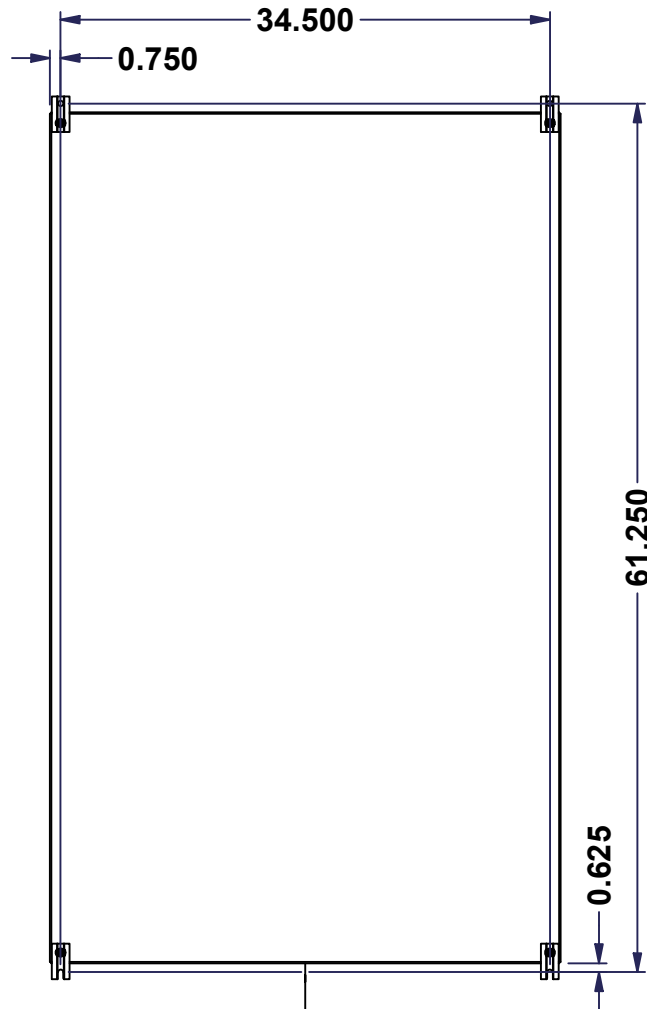

BACK

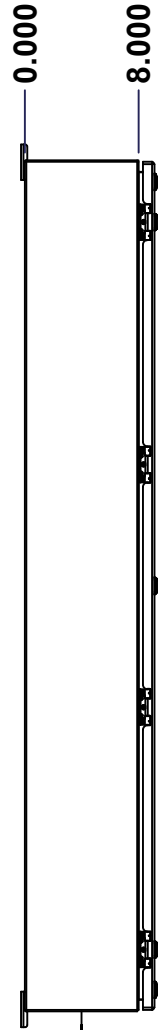

LEFT

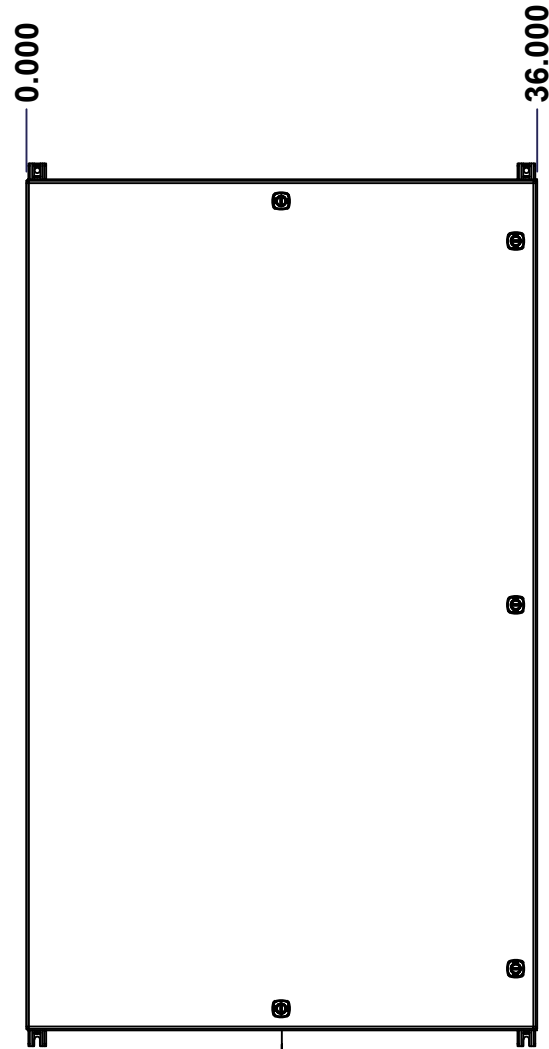

FRONT

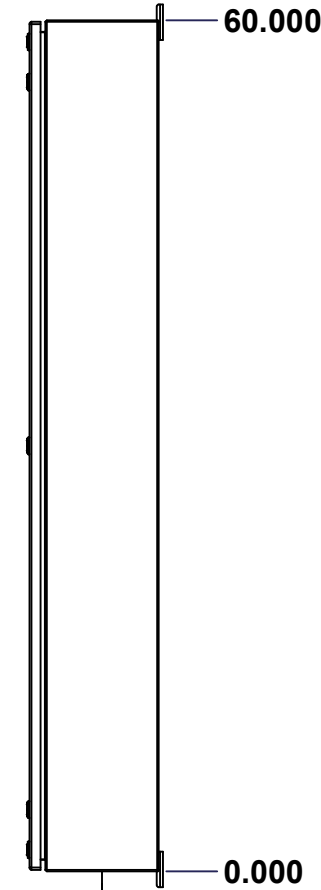

RIGHT

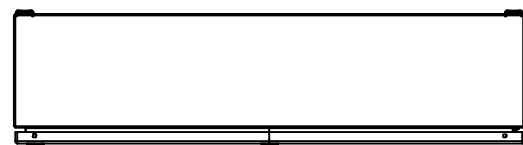

BOTTOM

No.	Revisions	Date	By/Par

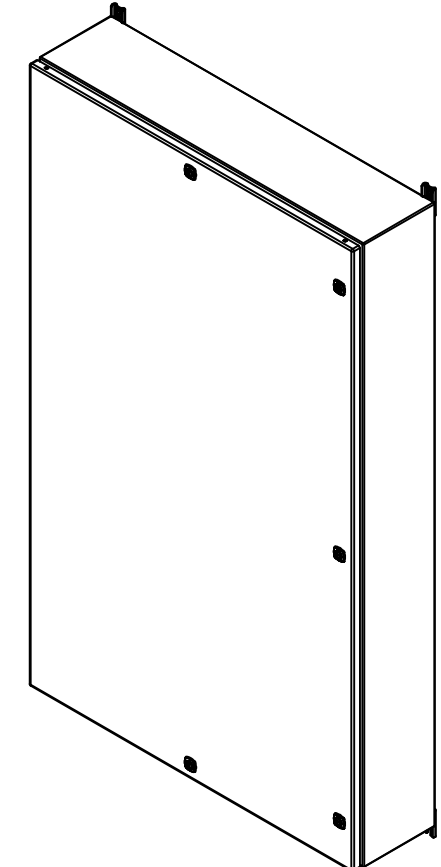

Isometric View

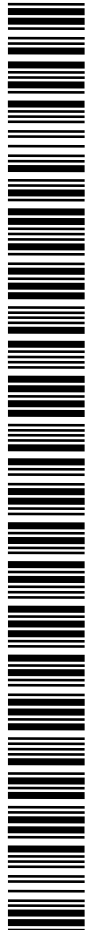

Tél: (450) 979-4373
 Fax: (450) 979-4626
www.exmweb.com

Flatness
 Aplatissement
 Max 3.0mm
 Projection

Customer Client	Date
Drawn By Dessiné Par BoxCad: BoxCad	Date 04-May-23
Material Matière 14 Ga Stainless Steel 304 (1.7mm)	
Color Couleur Asa-61 Grey	Finish Fini Smooth
Description 5412ESSP 60" x 36" x 8" Assembly	Detail Rev.
Part Number Numéro Pièce 5412ESSP603608TH	Rev. 0

SEE BILL OF MATERIAL ON LAST PAGE

This drawing is confidential and must not be reproduced or used without the consent of EXM

Ce dessin est confidentiel et ne doit pas être reproduit ou utilisé sans le consentement de EXM

NOTE	
ITEM	DESCRIPTION
1	NEMA 4X Enclosure
2	C/W Standard ground studs on box and cover
3	C/W Standard door stiffener
4	C/W Standard inner panel (Included)
5	C/W Standard inner panel mounting studs
6	C/W Special locks sold separately (Installed)
7	C/W 885 ESMF4_OPEN Sold separately (Installed)
8	C/W 885 ESMF4_CLOSE Sold separately (Installed)
9	C/W R5 Insulation (Installed by EXM)

No.	Revisions	Date	By/Par

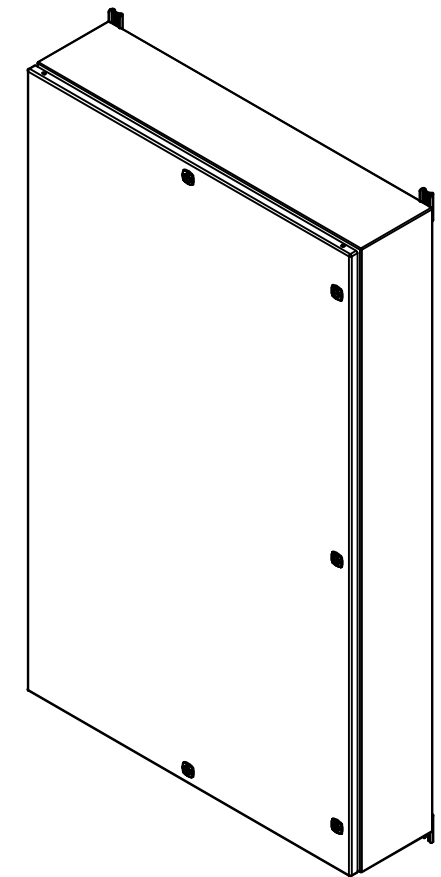

Isometric View

 Tél: (450) 979-4373
 Fax: (450) 979-4626
www.exmweb.com

Flatness
 Aplatissement
 Max 3.0mm
 Projection

Customer Client	Date
Drawn By Dessiné Par BoxCad: BoxCad	Date 04-May-23
Material Matière	14 Ga Stainless Steel 304 (1.7mm)

Color Couleur	Asa-61 Grey	Finish Fini	Smooth
Description		Detail Rev.	
5412ESSP 60" x 36" x 8" Assembly			
Part Number Numéro Pièce		Rev.	2
5412ESSP603608TH		0	16

PACKING		
ITEM	QTY	DESCRIPTION
Cardboard sleeve	2	Top and Bottom
Cardboard strip	2	Between back of enclosure and inner panel
Plastic bag	1	To protect cover surface and inside gasket
Cardboard corner	4	To reinforced for the plastic strap tightening
Plastic strap - Black	2	To Squeeze the 2 cardboard sleeve together
Packaging label	3	White label with PN
Plastic strap- Green	2	To secure the enclosure to the wood pallet
Wood Pallet	1	2" deeper and 3" larger than enclosure size

8	STK-Q-00600	2	M12 to M8 Adaptor
1	881 SP6036G	0	881 SP - Inner Panel
1	STK-K-01800	5	5412 ES Accessory Kit
1	5412ESSP603608THC	0	5412ESSP 60" x 36" Cover
1	5412ESSP603608THB	0	5412ESSP 60" x 36" x 8" Body
4	STK-Q-04051-08	1	M6 x 8mm Stainless Steel Hexagon Socket Head Machine Screw with Nyseal
Qty	Part Number	Rev	Description
Parts List			

This drawing is confidential and must not be reproduced or used without the consent of EXM

Ce dessin est confidentiel et ne doit pas être reproduit ou utilisé sans le consentement de EXM

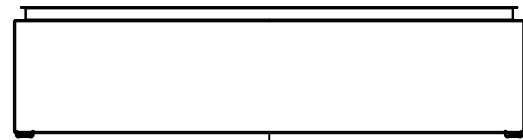

TOP

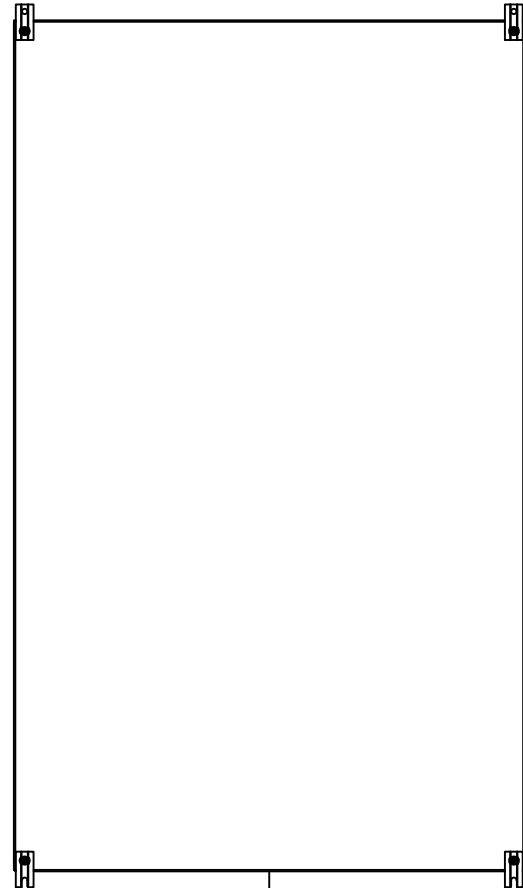

BACK

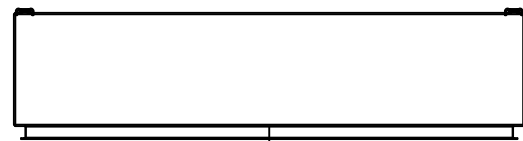

BOTTOM

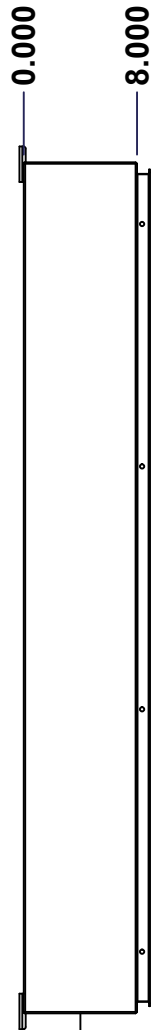

LEFT

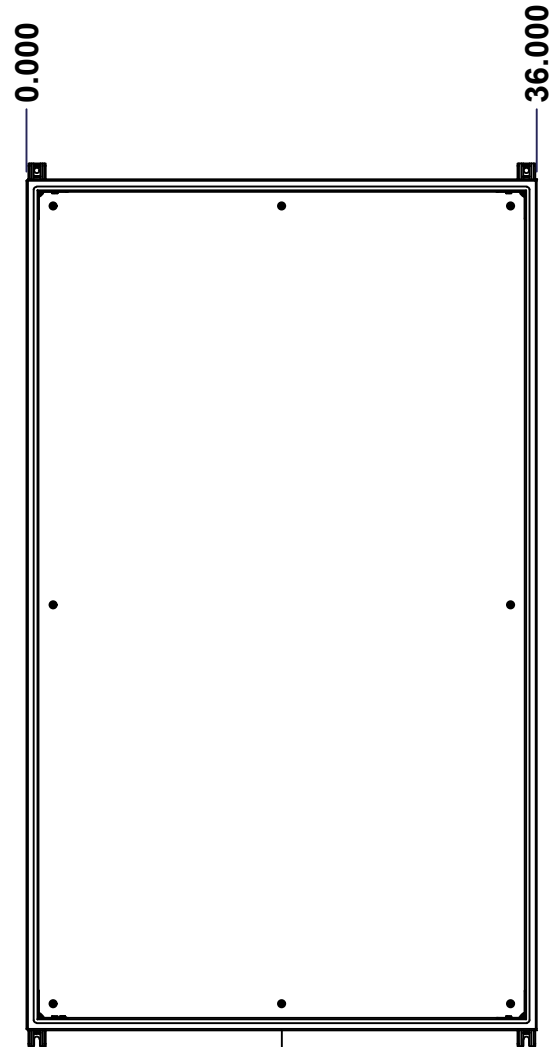

FRONT

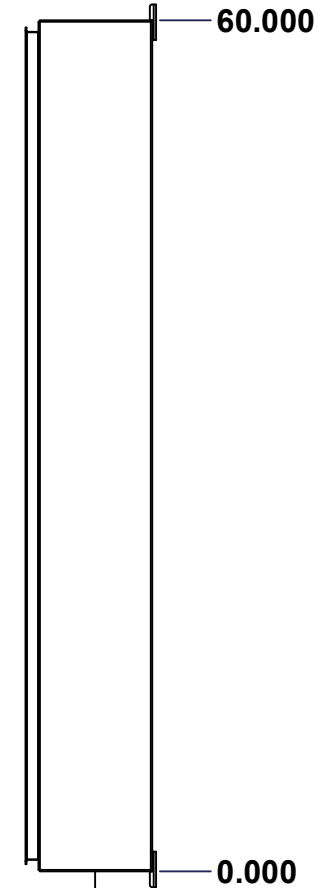

RIGHT

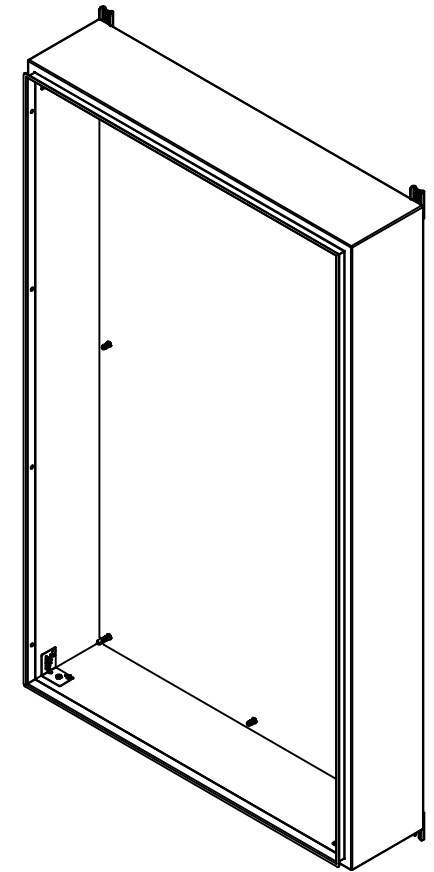

Isometric View

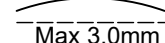
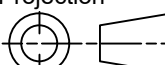

No.	Revisions	Date	By/Par

 Tél: (450) 979-4373 Fax: (450) 979-4626 www.exmweb.com		Flatness Aplatissement  Max 3.0mm Projection 
Customer Client	Date	
Drawn By Dessiné Par	BoxCad: BoxCad	Date 04-May-23
Material Matière	14 Ga Stainless Steel 304 (1.7mm)	
Color Couleur	Asa-61 Grey	Finish Fini Smooth
Description	Detail Rev.	
5412ESSP 60" x 36" x 8" Body		
Part Number Numéro Pièce	Rev. 0	3 / 16
5412ESSP603608THB		

SEE BILL OF MATERIAL ON LAST PAGE

This drawing is confidential and must not be reproduced or used without the consent of EXM

Ce dessin est confidentiel et ne doit pas être reproduit ou utilisé sans le consentement de EXM

STANDARD FEATURES ARE NOT LISTED IN THIS HOLE TABLE			
HOLE TABLE - TOP VIEW (CUSTOM FEATURE ONLY)			
CUT-OUT	XDIM	YDIM	DESCRIPTION
1	2.000	6.500	INSUL. STUD M6 x 18mm (Inside)
2	34.000	6.500	INSUL. STUD M6 x 18mm (Inside)

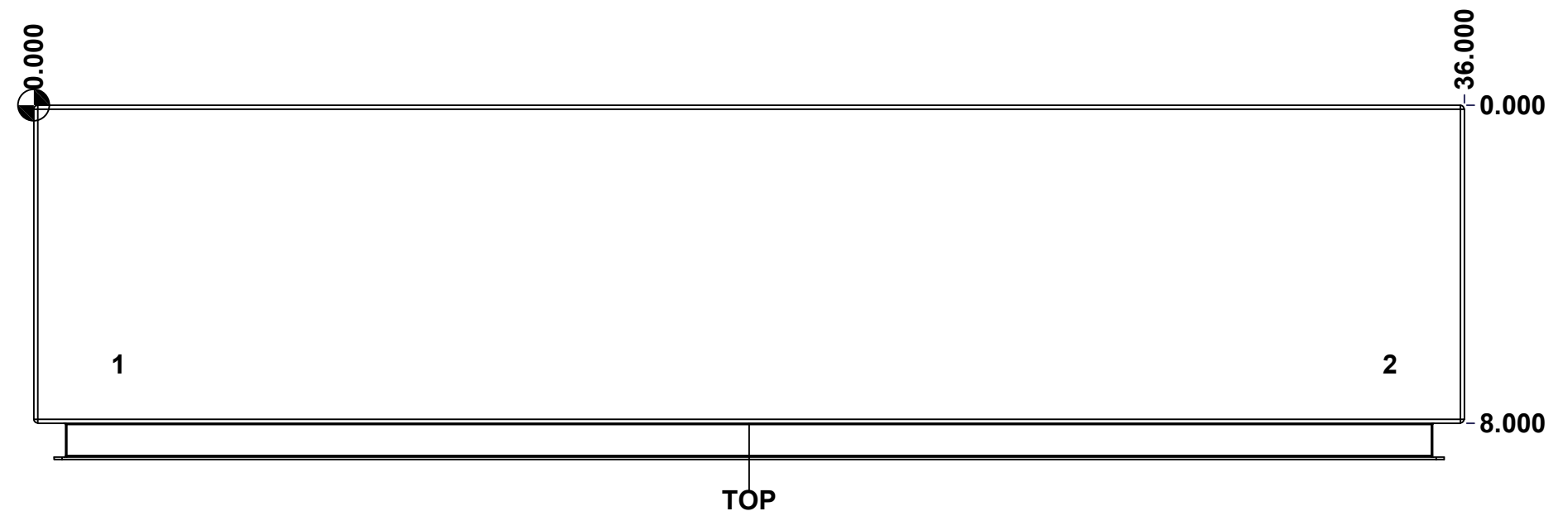

	Description	Status	
	5412ESSP 60" x 36" x 8" Body	(NULL)	
	Part Number Numéro Pièce	Rev.	4
	5412ESSP603608THB	0	16

This drawing is confidential and must not be reproduced or used without the consent of EXM

Ce dessin est confidentiel et ne doit pas être reproduit ou utilisé sans le consentement de EXM

STANDARD FEATURES ARE NOT LISTED IN THIS HOLE TABLE			
HOLE TABLE - BOTTOM VIEW (CUSTOM FEATURE ONLY)			
CUT-OUT	XDIM	YDIM	DESCRIPTION
1	2.000	6.500	INSUL. STUD M6 x 18mm (Inside)
2	34.000	6.500	INSUL. STUD M6 x 18mm (Inside)

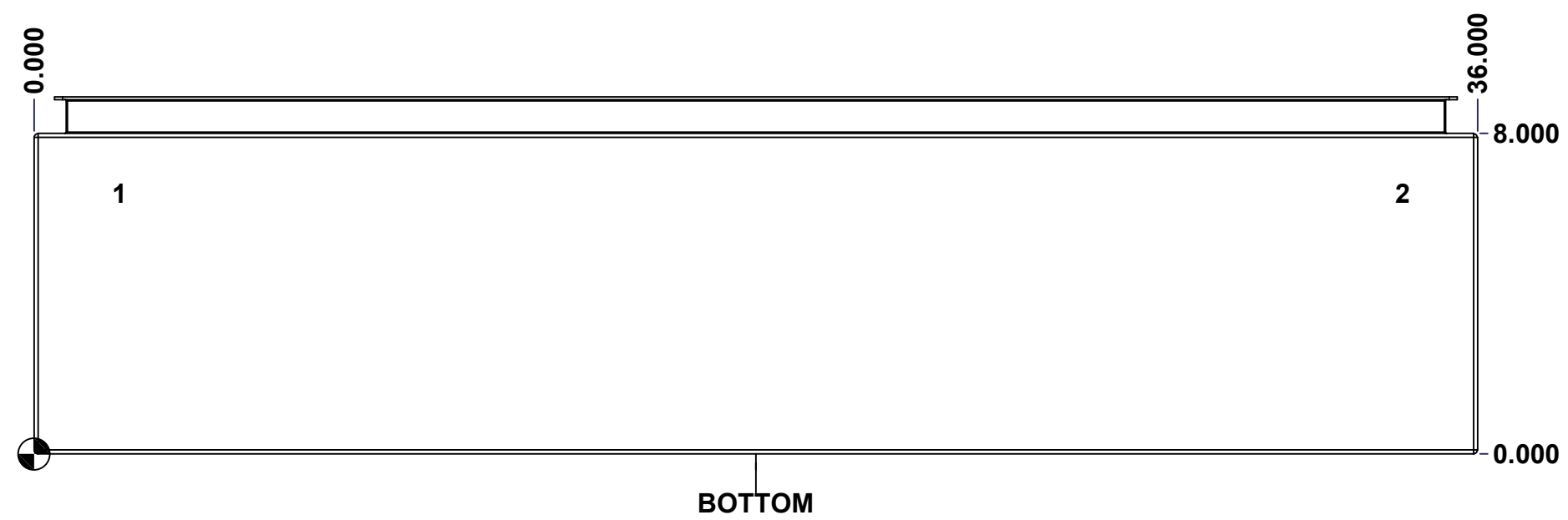

	Description		Status
	5412ESSP 60" x 36" x 8" Body		(NULL)
Part Number Numéro Pièce		Rev.	5
5412ESSP603608THB		0	16

This drawing is confidential and must not be reproduced or used without the consent of EXM

Ce dessin est confidentiel et ne doit pas être reproduit ou utilisé sans le consentement de EXM

STANDARD FEATURES ARE NOT LISTED IN THIS HOLE TABLE

HOLE TABLE - BACK VIEW (CUSTOM FEATURE ONLY)

CUT-OUT	XDIM	YDIM	DESCRIPTION
1	1.875	1.875	IP STUD M8 x 35mm (Inside)
2	1.875	58.125	IP STUD M8 x 35mm (Inside)
3	34.125	58.125	IP STUD M8 x 35mm (Inside)
4	34.125	1.875	IP STUD M8 x 35mm (Inside)
5	1.875	30.000	IP STUD M8 x 35mm (Inside)
6	34.125	30.000	IP STUD M8 x 35mm (Inside)
7	18.000	1.875	IP STUD M8 x 35mm (Inside)
8	18.000	58.125	IP STUD M8 x 35mm (Inside)

9	35.250	0.000	FOOT 885 ESMF4_OPEN
10	0.750	0.000	FOOT 885 ESMF4_OPEN
11	35.250	60.000	FOOT 885 ESMF4_CLOSE
12	0.750	60.000	FOOT 885 ESMF4_CLOSE

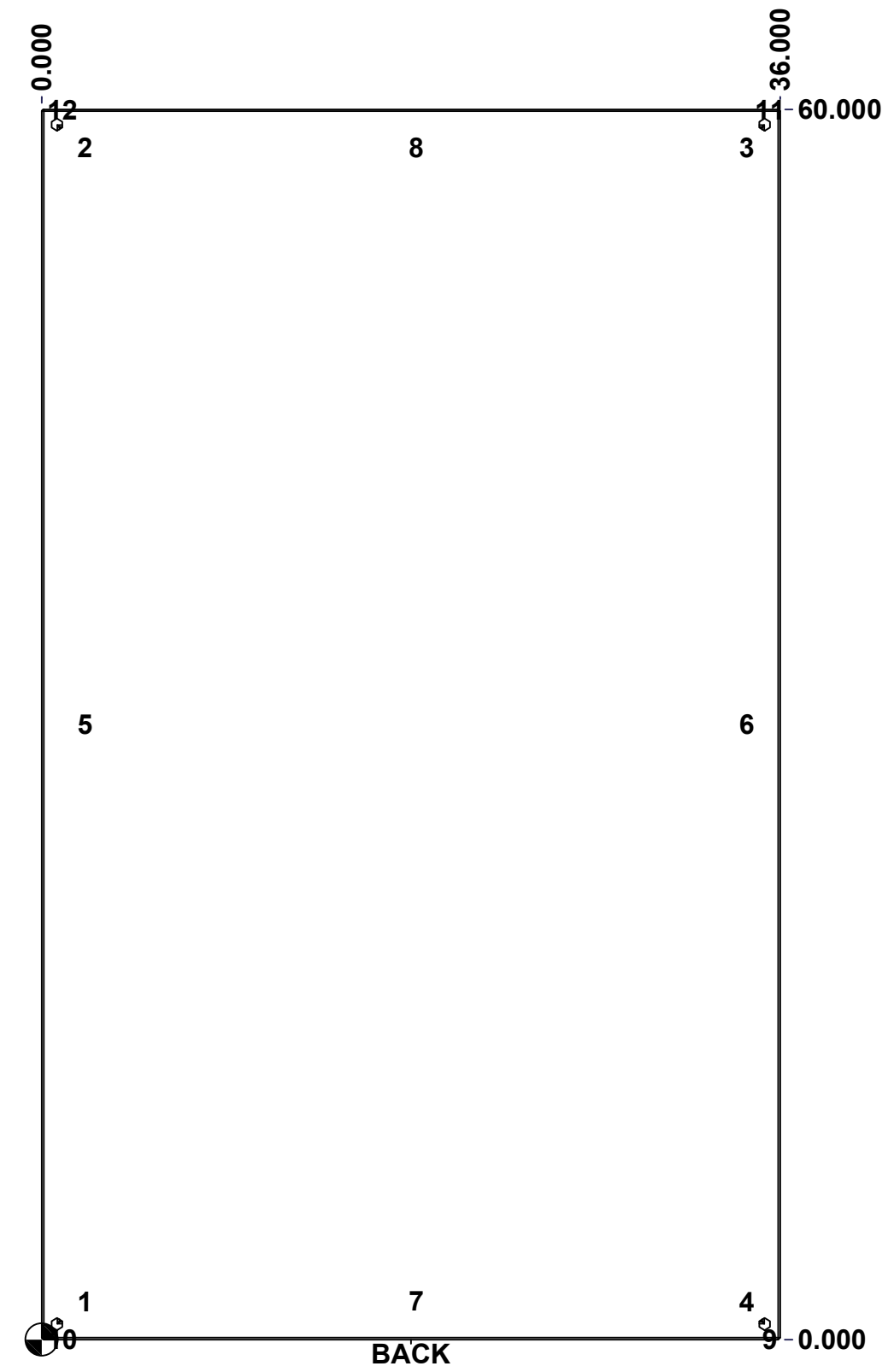

	Description	Status
	5412ESSP 60" x 36" x 8" Body	(NULL)
	Part Number Numéro Pièce	Rev.
	5412ESSP603608THB	0 / 6
		16

This drawing is confidential and must not be reproduced or used without the consent of EXM

Ce dessin est confidentiel et ne doit pas être reproduit ou utilisé sans le consentement de EXM

No.	Revisions	Date	By/Par

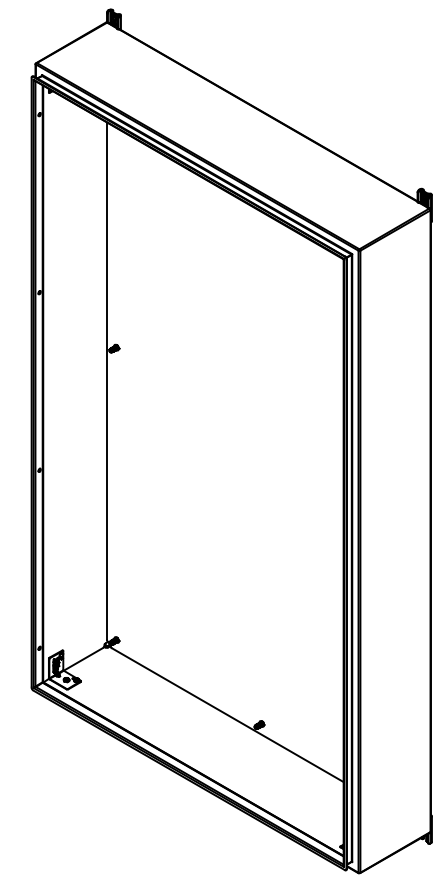

Isometric View



2	885ESMF4-FEET	0	885 ESMF4 Stainless Steel Mounting Foot
4	RIVET_NUT_SS_M10_FH_CE	0	Stainless Steel Rivet Nut M10 (Low Profile Close End)
4	STK-Q-06670	2	M10 x 16mm Stainless Steel Machine Screw
2	885ESMF4-FEET-A	0	885 ESMF4 Stainless Steel Mounting Foot (Opened Slot)
1	STK-K-70554	3	5412 ESTH Accessory Kit
1	5412ESSP603608THI-RS	0	5412ESSP 60" x 36" Right Insulation
1	5412ESSP603608THI-LS	0	5412ESSP 60" x 36" Left Insulation
1	5412ESSP603608THI-BT	0	5412ESSP 60" x 36" Top and Bottom Insulation
1	5412ESSP603608THI-TP	0	5412ESSP 60" x 36" Top and Bottom Insulation
1	5412ESSP603608THI-B	0	5412ESSP 60" x 36" Back Insulation
4	STK-Q-16070	1	Stud M6 x 18mm Stainless steel
1	STK-P-02400S	0	Powder Paint (Asa-61 Grey / Smooth)
8	STK-Q-16020	1	Stud M8 x 35mm Stainless Steel
1	5412ESSP603608THB-P	0	5412ESSP 60" x 36" x 8" Body Part

Qty	Part Number	Rev	Description
Parts List			

	Tél: (450) 979-4373 Fax: (450) 979-4626 www.exmweb.com	Flatness Aplatissement Max 3.0mm
	Projection 	Date 04-May-23
Customer Client	BoxCad: BoxCad	Date
Drawn By / Dessiné Par	BoxCad: BoxCad	Date
Material / Matière	14 Ga Stainless Steel 304 (1.7mm)	
Color / Couleur	Asa-61 Grey	Finish / Fini: Smooth
Description	5412ESSP 60" x 36" x 8" Body	
Part Number / Numéro Pièce	5412ESSP603608THB	Rev. 7 / 16

This drawing is confidential and must not be reproduced or used without the consent of EXM

Ce dessin est confidentiel et ne doit pas être reproduit ou utilisé sans le consentement de EXM

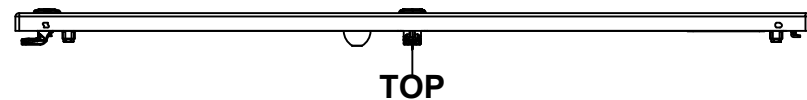

TOP

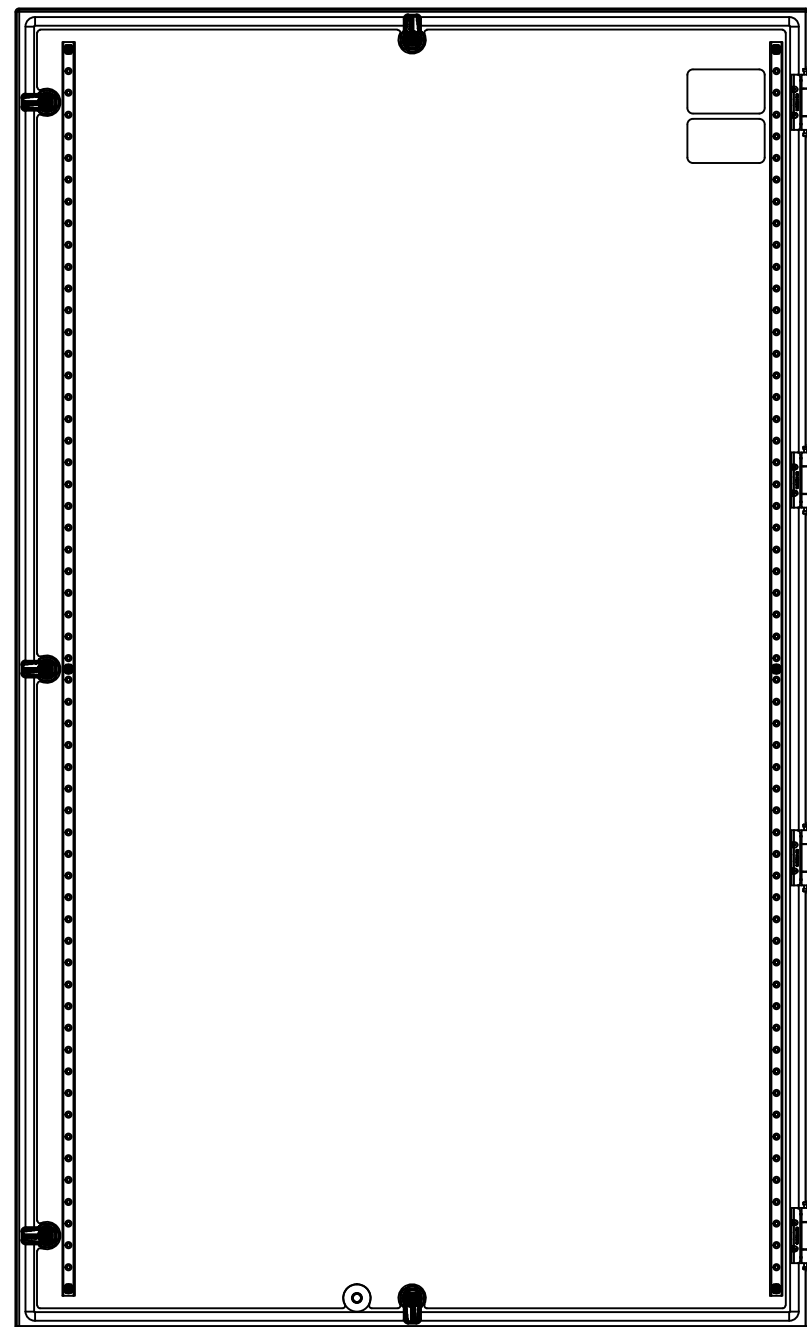

BACK



BOTTOM

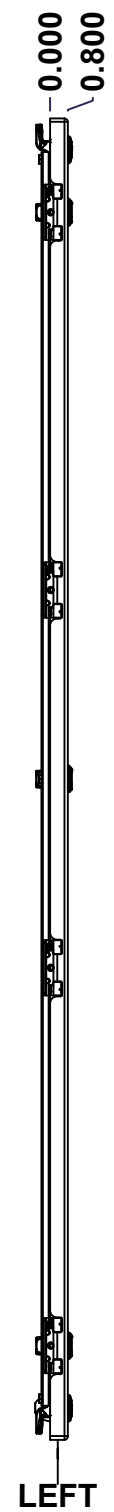

LEFT

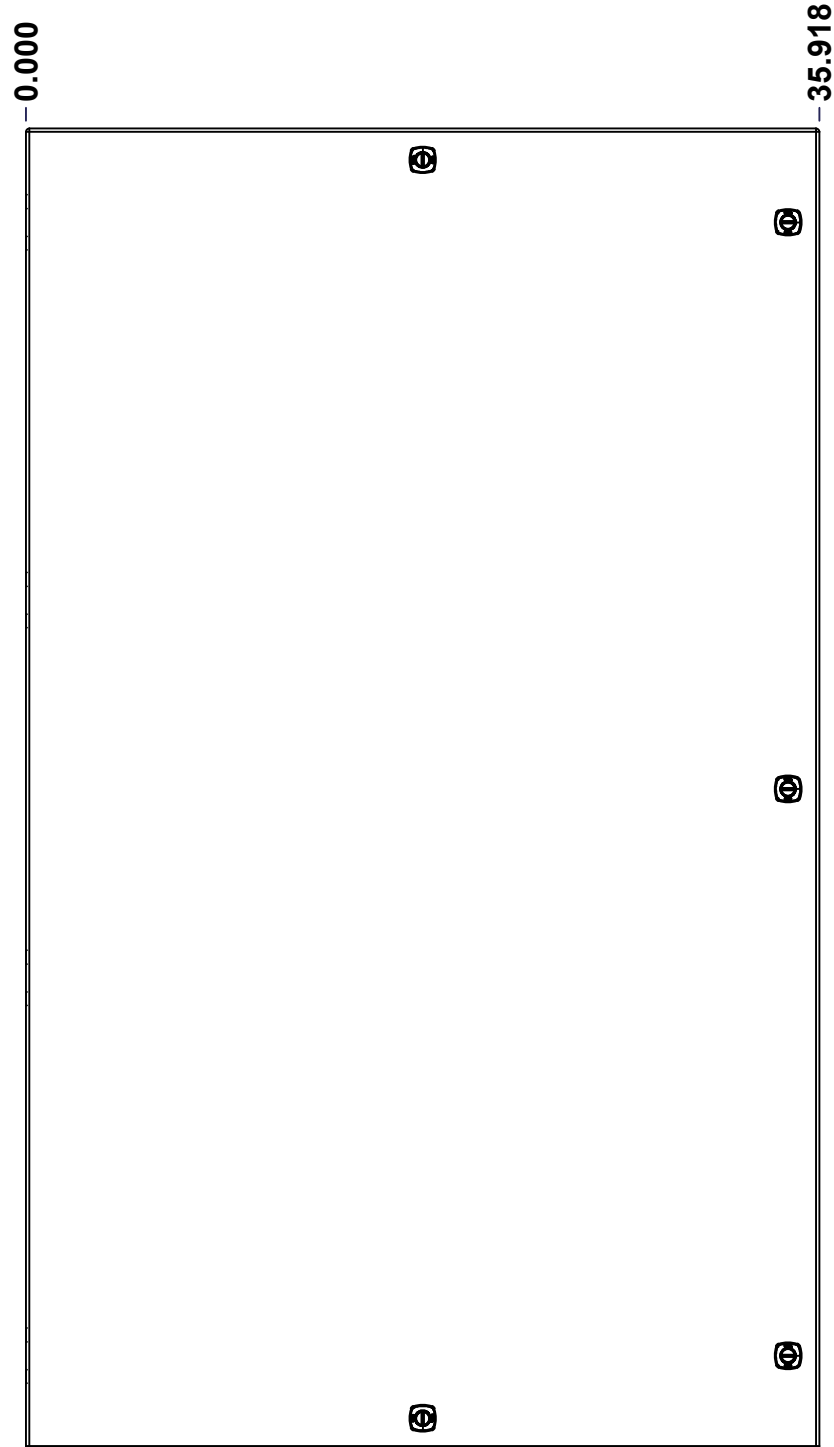

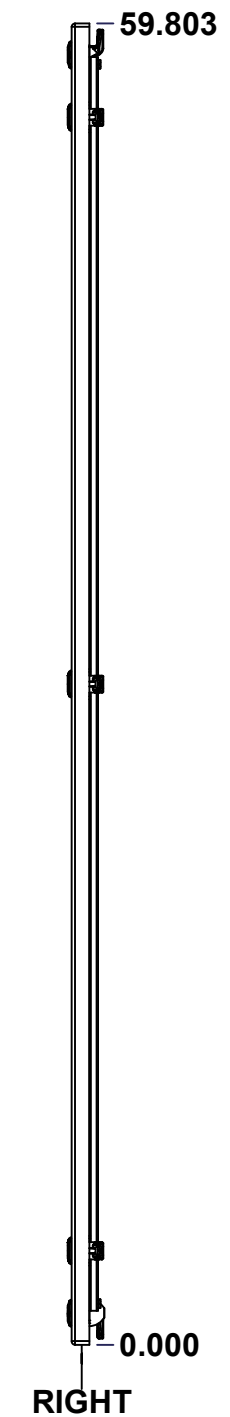

FRONT

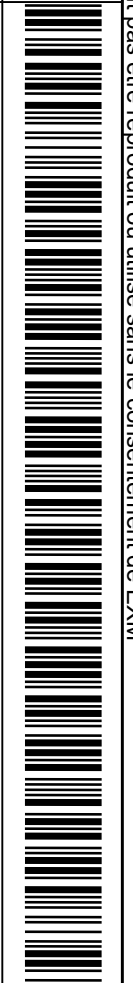
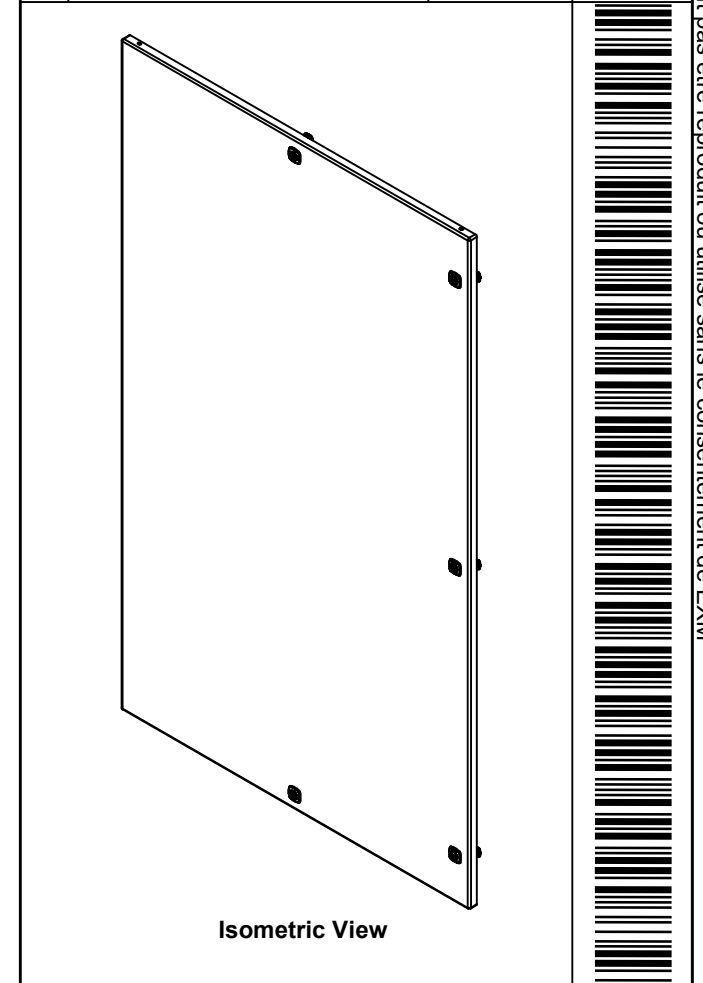

RIGHT

No.	Revisions	Date	By/Par



 Tél: (450) 979-4373 Fax: (450) 979-4626 www.exmweb.com		Flatness Aplatissement
		Max 3.0mm
Customer Client		Date
Drawn By Dessiné Par BoxCad: BoxCad		Date 04-May-23
Material Matière 14 Ga Stainless Steel 304 (1.7mm)		
Color Couleur Asa-61 Grey	Finish Fini Smooth	
Description 5412ESSP 60" x 36" Cover		Detail Rev.
Part Number Numéro Pièce	Rev. 8	16
5412ESSP603608THC		0

SEE BILL OF MATERIAL ON LAST PAGE

This drawing is confidential and must not be reproduced or used without the consent of EXM

Ce dessin est confidentiel et ne doit pas être reproduit ou utilisé sans le consentement de EXM

STANDARD FEATURES ARE NOT LISTED IN THIS HOLE TABLE

HOLE TABLE - FRONT VIEW (CUSTOM FEATURE ONLY)

CUT-OUT	XDIM	YDIM	DESCRIPTION
1	1.486	1.850	STUD M6 x 18mm (Inside)
2	1.486	57.953	STUD M6 x 18mm (Inside)
3	33.517	57.953	STUD M6 x 18mm (Inside)
4	33.517	1.850	STUD M6 x 18mm (Inside)
5	1.486	29.902	STUD M6 x 18mm (Inside)
6	33.517	29.902	STUD M6 x 18mm (Inside)
7	20.459	1.435	STUD M6 x 18mm (Inside)

8	34.494	55.553	880 SCQ4-SLSS6
9	34.494	29.902	880 SCQ4-SLSS6
10	34.494	4.250	880 SCQ4-SLSS6
11	17.959	58.379	880 SCQ4-SLSS6
12	17.959	1.424	880 SCQ4-SLSS6

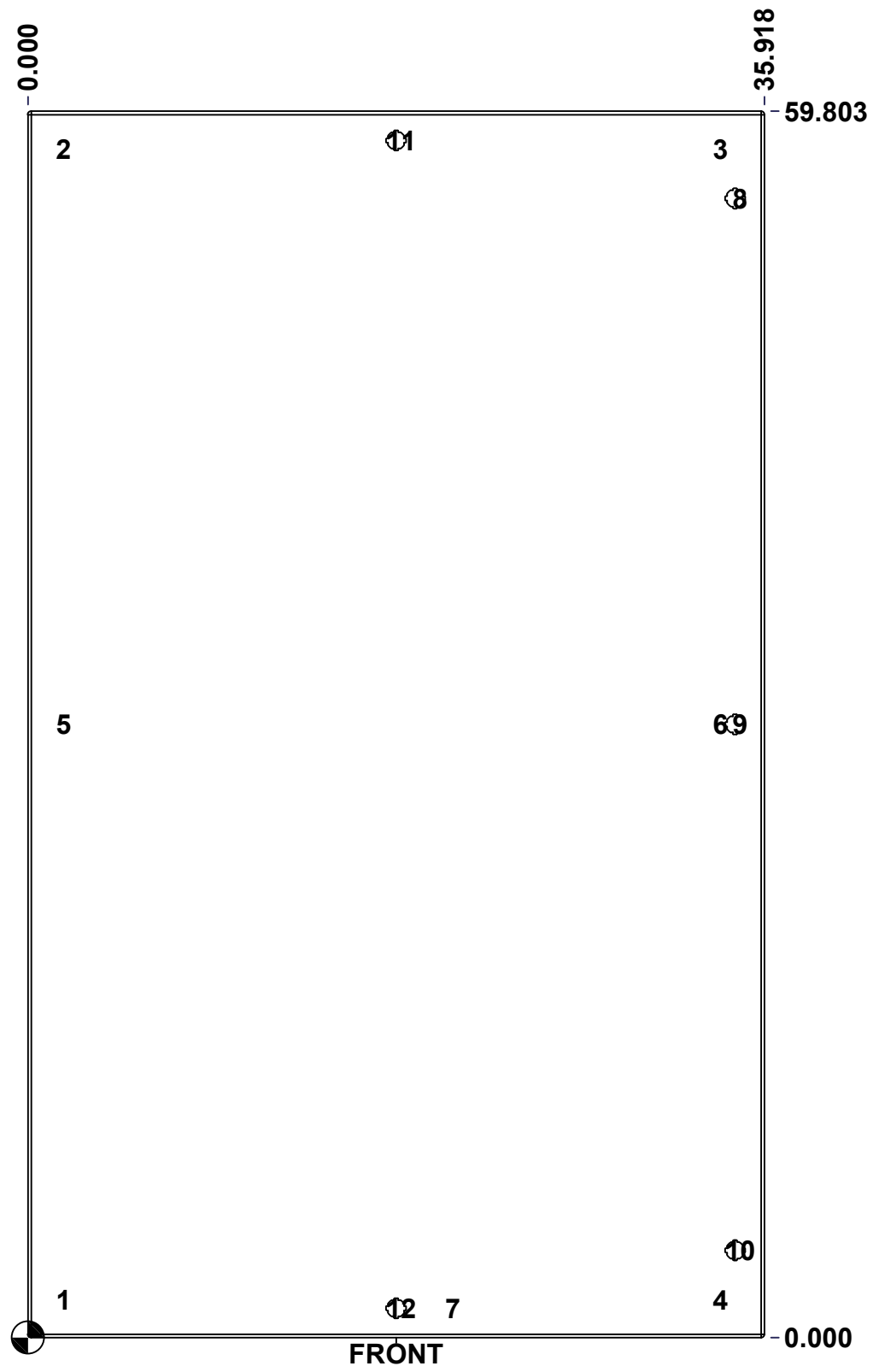

	Description	Status
	5412ESSP 60" x 36" Cover	(NULL)
	Part Number Numéro Pièce	Rev.
	5412ESSP603608THC	0
		9
		16

This drawing is confidential and must not be reproduced or used without the consent of EXM

Ce dessin est confidentiel et ne doit pas être reproduit ou utilisé sans le consentement de EXM

No.	Revisions	Date	By/Par

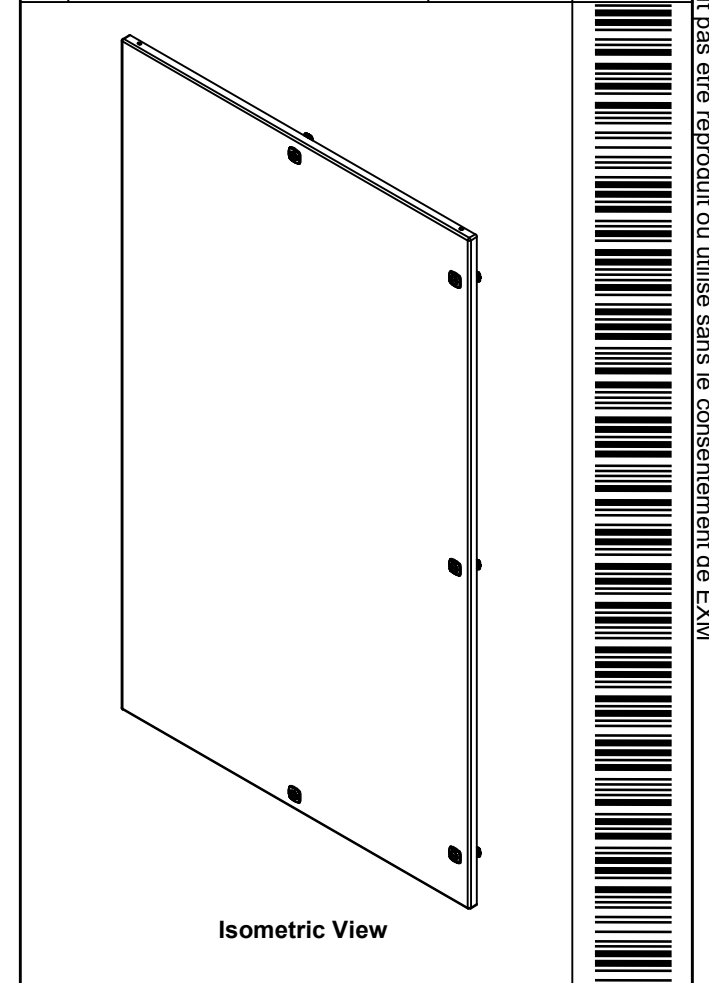

EXM
www.exmweb.com

Tél: (450) 979-4373
Fax: (450) 979-4626

Flatness
Aplatissement
Max 3.0mm

Projection

2	STK-S-00100	0	3.5" x 2" Silver Milar Flexcon Sticker
6	STK-Q-07250	2	M6 x 16mm Collar Nut
2	STK-Q-46020-60	5	5412 ES Vertical Door Stiffener 60"
1	5412ESSP603608THI-C	0	5412ESSP 60" x 36" Cover Insulation
1	STK-P-02400S	0	Powder Paint (Asa-61 Grey / Smooth)
1	STK-Q-46515	3	5412 ES Door Support with Brass Insert
7	STK-Q-16070	1	Stud M6 x 18mm Stainless steel
1	5412ESSP603608THG	0	5412ESSP 60" x 36" Cover Gasket Part
1	5412ESSP603608THC-P	0	5412ESSP 60" x 36" Cover Part
5	880 SCQ4-SLSS6	7	5412 ESS 1/4 Turn Lock
4	STK-A-33016	0	5412 ESS Bended Hinge (Body Part)
QTY	Part Number	Rev	Description
Parts List			

Customer Client	Date
Drawn By Dessiné Par	Date 04-May-23
Material Matière	14 Ga Stainless Steel 304 (1.7mm)
Color Couleur	Asa-61 Grey
Finish Fini	Smooth
Description	Detail Rev.
5412ESSP 60" x 36" Cover	
Part Number Numéro Pièce	Rev. 10
5412ESSP603608THC	0 16

This drawing is confidential and must not be reproduced or used without the consent of EXM

Ce dessin est confidentiel et ne doit pas être reproduit ou utilisé sans le consentement de EXM

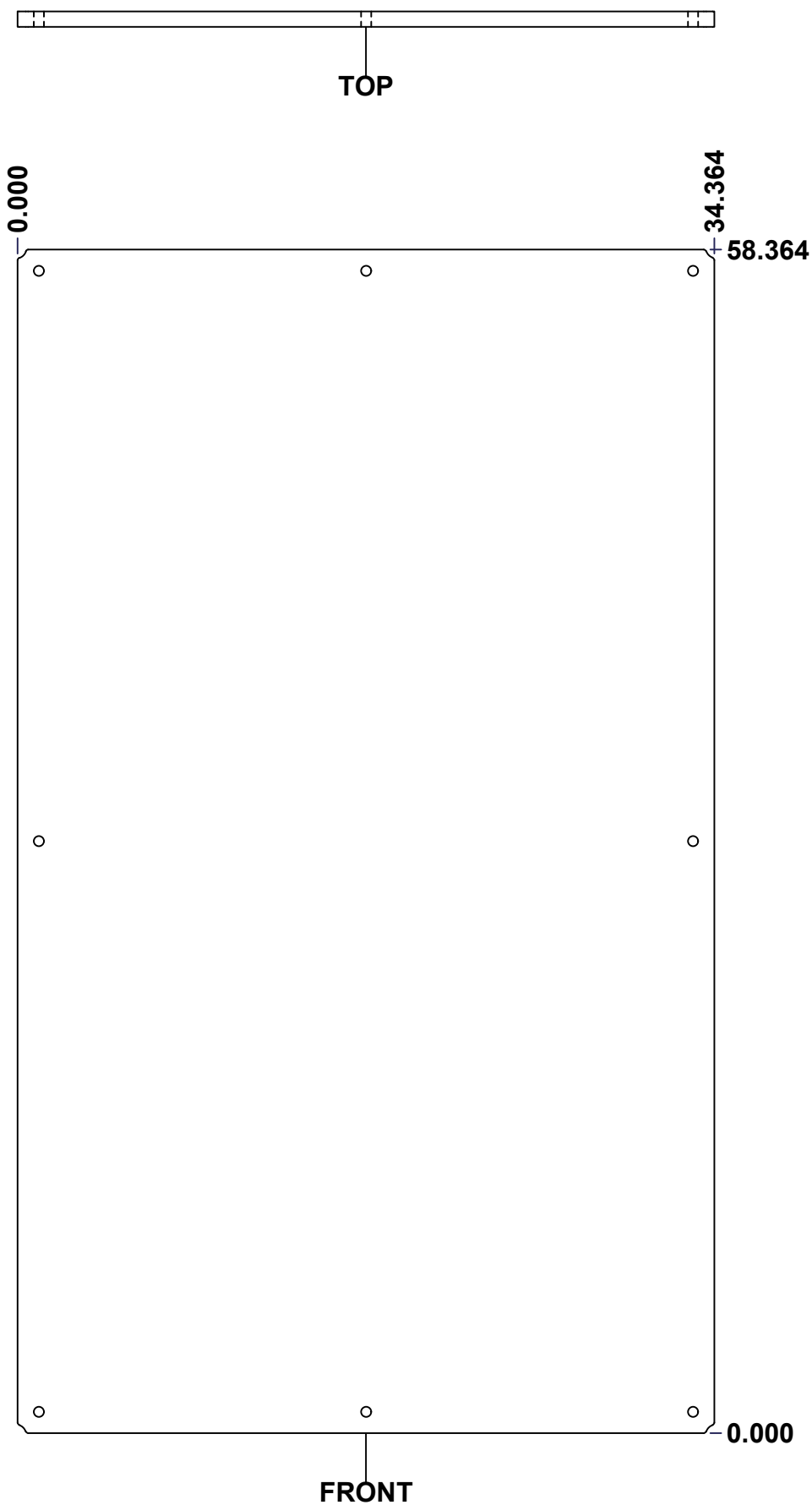

No.	Revisions	Date	By/Par

Isometric View

Tél: (450) 979-4373 Fax: (450) 979-4626 www.exmweb.com		Flatness Aplatissement Max 3.0mm Projection
Customer Client	Date	
Drawn By Dessiné Par	BoxCad: Patrick Deschenes	Date 23-Jan-07
Material Matière	Polyisocyanurate	
Color Couleur	Aluminum	Finish Fini N/A
Description		Detail Rev.
5412ESSP 60" x 36" Back Insulation		
Part Number Numéro Pièce	Rev.	11
5412ESSP603608THI-B	0	16

SEE BILL OF MATERIAL ON LAST PAGE

This drawing is confidential and must not be reproduced or used without the consent of EXM

Ce dessin est confidentiel et ne doit pas être reproduit ou utilisé sans le consentement de EXM

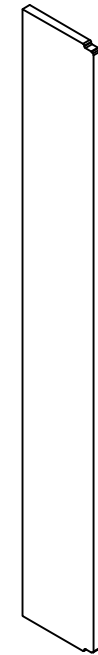
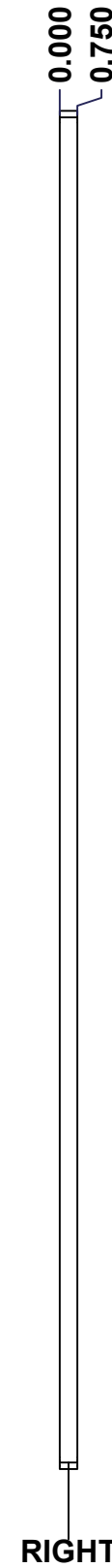
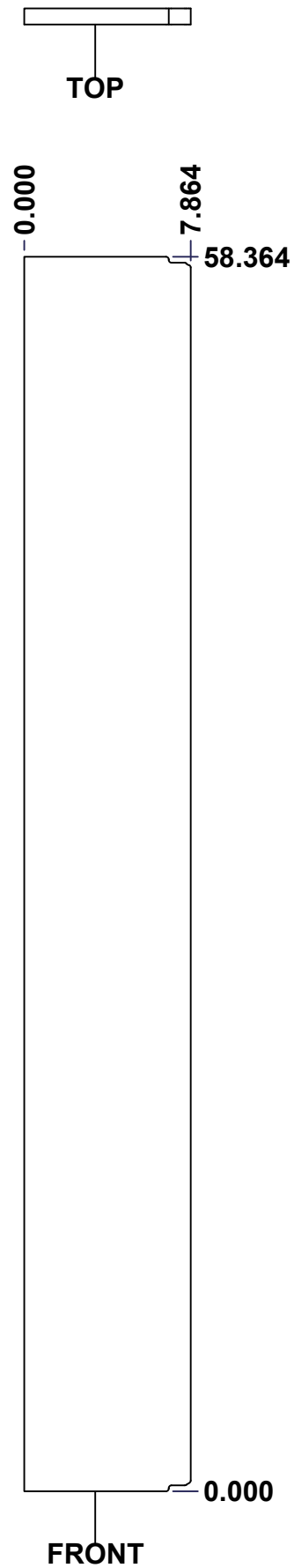

Isometric View



Tél: (450) 979-4373
 Fax: (450) 979-4626
www.exmweb.com

Flatness
Aplatissement

Max 3.0mm

Projection

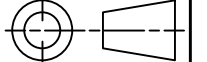

Customer Client	Date
Drawn By Dessiné Par	Date
Material Matière	23-Jan-07
Polyisocyanurate	
Color Couleur	Finish Fini
Aluminum	N/A
Description	Detail Rev.
5412ESSP 60" x 36" Left Insulation	
Part Number Numéro Pièce	Rev.
5412ESSP603608THI-LS	12
	0
	16

SEE BILL OF MATERIAL ON LAST PAGE

This drawing is confidential and must not be reproduced or used without the consent of EXM

Ce dessin est confidentiel et ne doit pas être reproduit ou utilisé sans le consentement de EXM

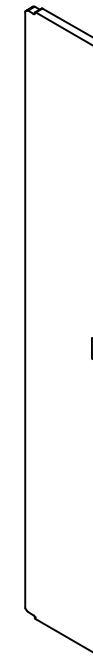
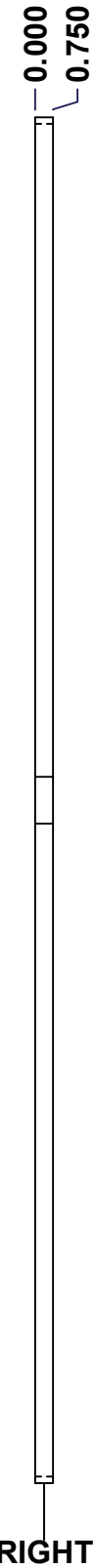
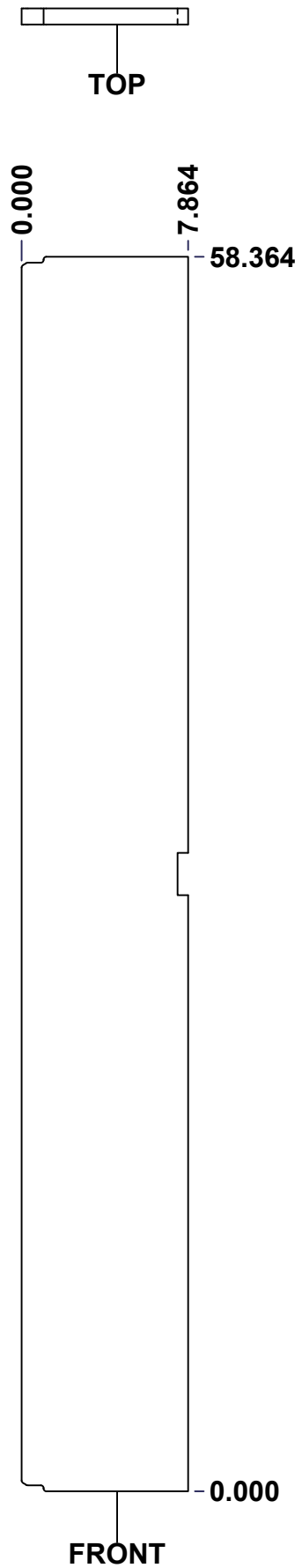

Isometric View

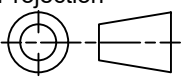

No.	Revisions	Date	By/Par

 Tél: (450) 979-4373 Fax: (450) 979-4626 www.exmweb.com		Flatness Aplatissement Max 3.0mm
Projection 		Date 23-Jan-07
Customer Client	Date	
Drawn By / Dessiné Par: BoxCad: Patrick Deschenes	Date: 23-Jan-07	
Material / Matière: Polyisocyanurate	Date	
Color / Couleur: Aluminum	Finish / Fini: N/A	Date
Description: 5412ESSP 60" x 36" Right Insulation		Detail Rev.
Part Number / Numéro Pièce: 5412ESSP603608TH-RS	Rev. 0	13 / 16

SEE BILL OF MATERIAL ON LAST PAGE

This drawing is confidential and must not be reproduced or used without the consent of EXM

Ce dessin est confidentiel et ne doit pas être reproduit ou utilisé sans le consentement de EXM



TOP

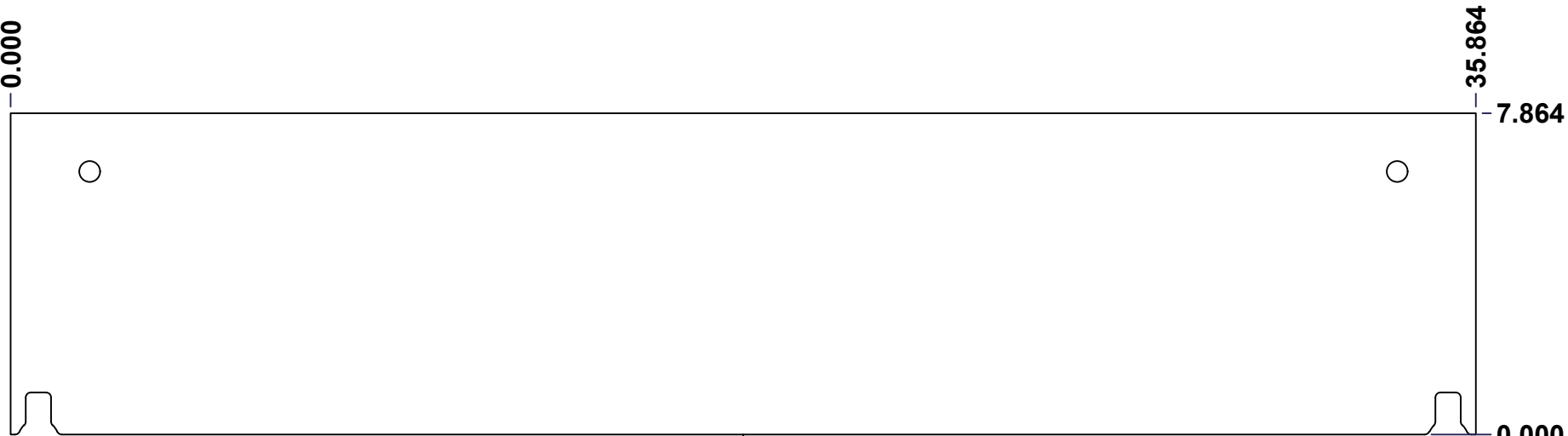

FRONT

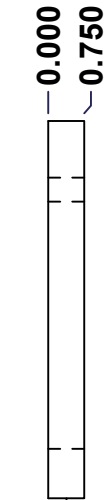

RIGHT

No.	Revisions	Date	By/Par

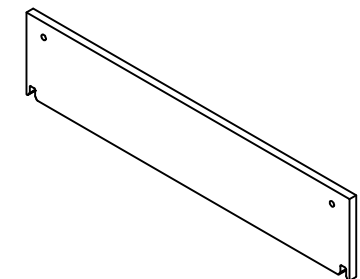

Isometric View



Tél: (450) 979-4373
 Fax: (450) 979-4626
www.exmweb.com

Flatness
Aplatissement
Max 3.0mm
Projection

Customer Client	Date
Drawn By / Dessiné Par: BoxCad: Patrick Deschenes	Date: 23-Jan-07
Material / Matière: Polyisocyanurate	
Color / Couleur: Aluminum	Finish / Fini: N/A
Description: 5412ESSP 60" x 36" Top and Bottom Insulation	Detail Rev.
Part Number / Numéro Pièce: 5412ESSP603608THI-TP	Rev. 0

SEE BILL OF MATERIAL ON LAST PAGE

This drawing is confidential and must not be reproduced or used without the consent of EXM

Ce dessin est confidentiel et ne doit pas être reproduit ou utilisé sans le consentement de EXM

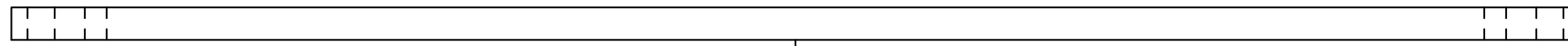

TOP

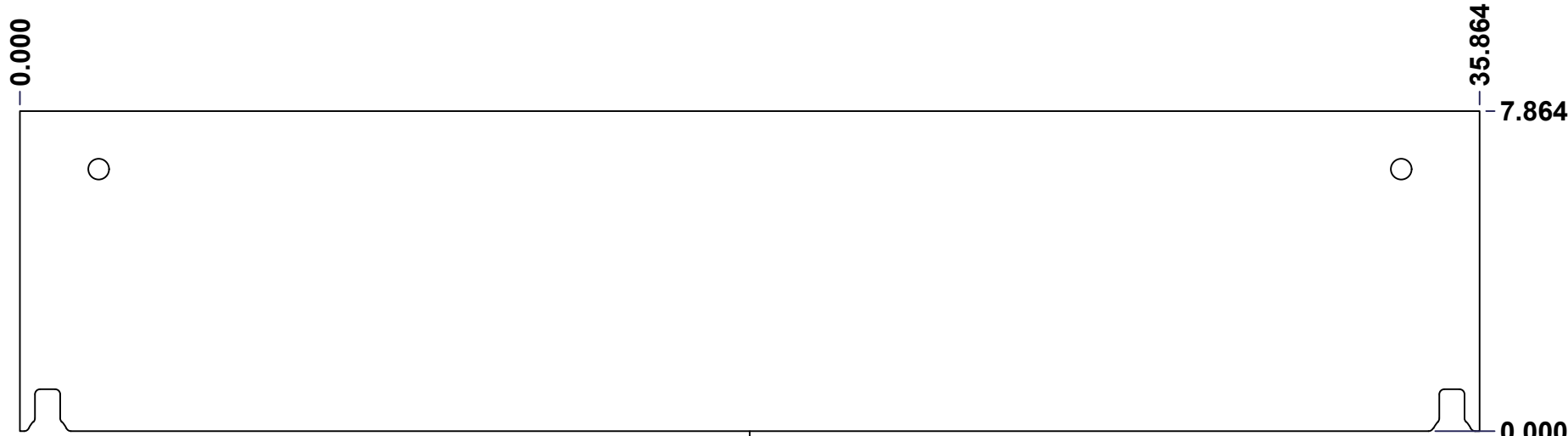

FRONT

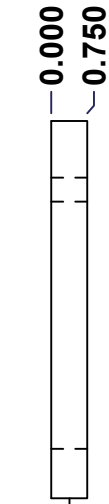

RIGHT

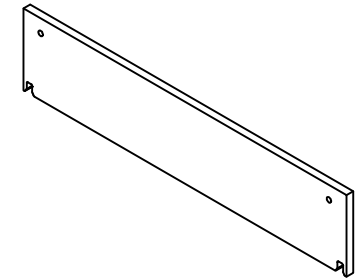

Isometric View



Tél: (450) 979-4373
 Fax: (450) 979-4626
www.exmweb.com

Flatness
Aplatissement

Max 3.0mm

Projection

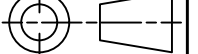

Customer Client	Date
Drawn By / Dessiné Par: BoxCad: Patrick Deschenes	Date: 23-Jan-07
Material / Matière: Polyisocyanurate	
Color / Couleur: Aluminum	Finish / Fini: N/A
Description: 5412ESSP 60" x 36" Top and Bottom Insulation	Detail Rev.
Part Number / Numéro Pièce: 5412ESSP603608THI-BT	Rev. 0

SEE BILL OF MATERIAL ON LAST PAGE

This drawing is confidential and must not be reproduced or used without the consent of EXM

Ce dessin est confidentiel et ne doit pas être reproduit ou utilisé sans le consentement de EXM

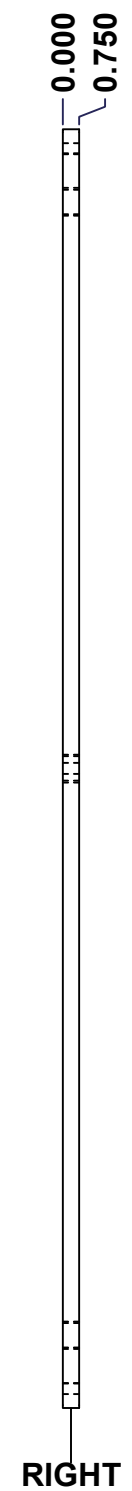
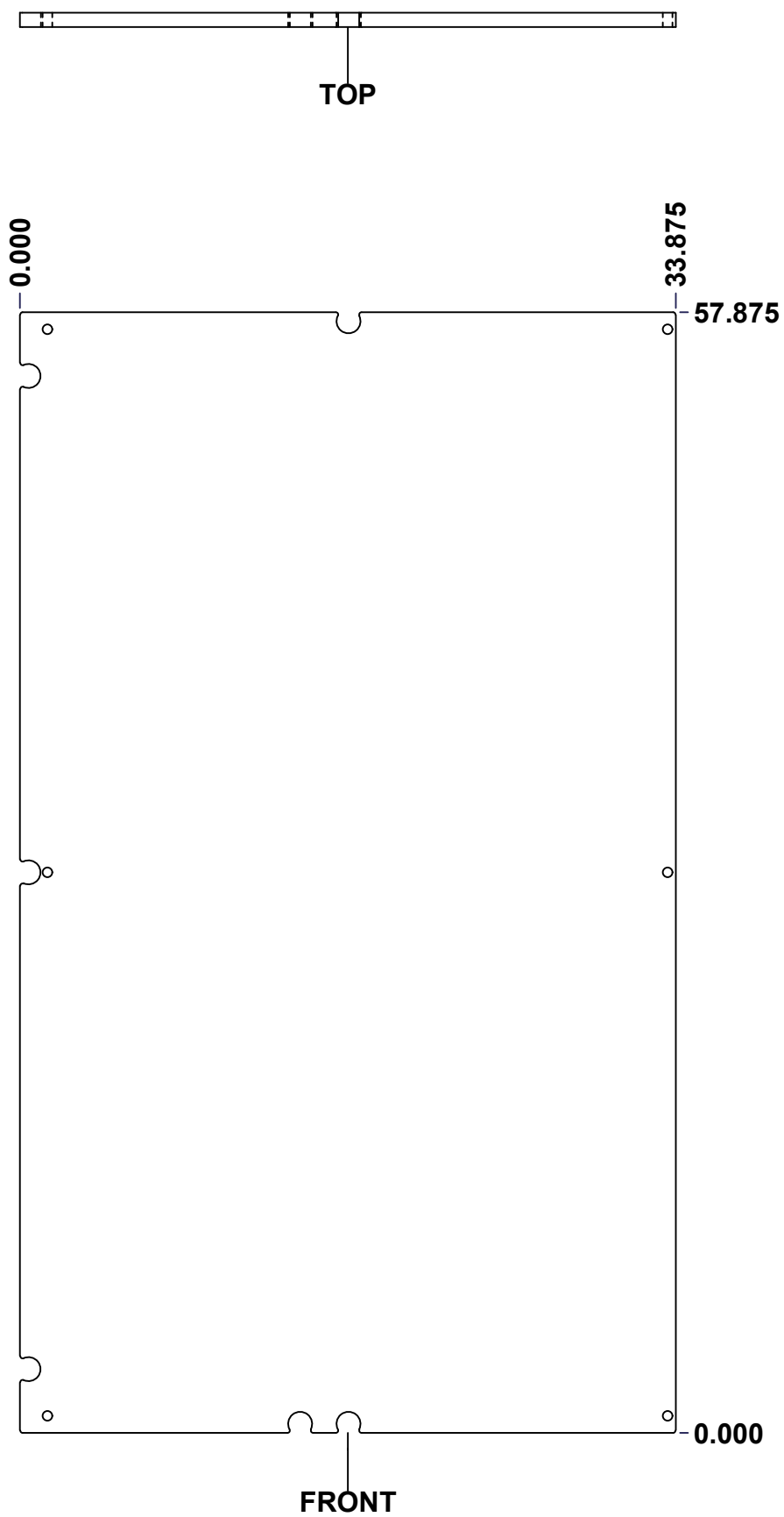

No.	Revisions	Date	By/Par

Isometric View

Tél: (450) 979-4373 Fax: (450) 979-4626 www.exmweb.com		Flatness Aplatissement
		Max 3.0mm
Projection		Date
Customer Client	BoxCad: Patrick Deschenes	Date
Drawn By Dessiné Par	BoxCad: Patrick Deschenes	Date 23-Jan-07
Material Matière	Polyisocyanurate	
Color Couleur	Aluminum	Finish Fini N/A
Description	Detail Rev.	
5412ESSP 60" x 36" Cover Insulation		
Part Number Numéro Pièce	Rev.	16
5412ESSP603608THI-C	0	16

SEE BILL OF MATERIAL ON LAST PAGE

This drawing is confidential and must not be reproduced or used without the consent of EXM

Ce dessin est confidentiel et ne doit pas être reproduit ou utilisé sans le consentement de EXM

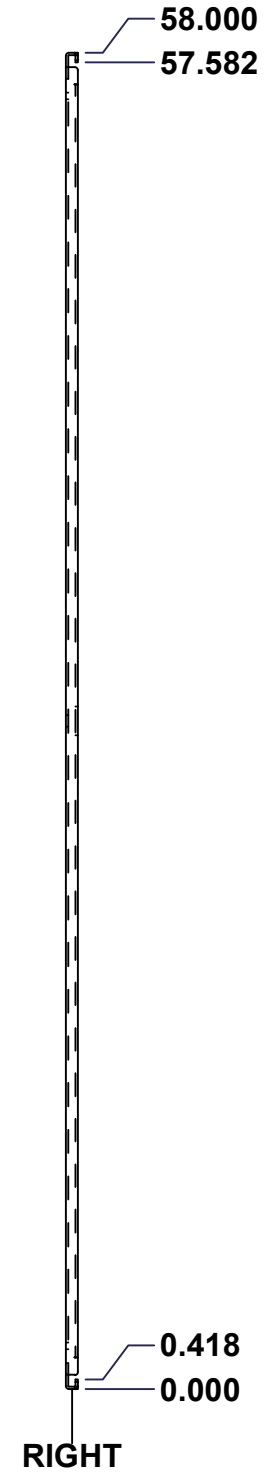
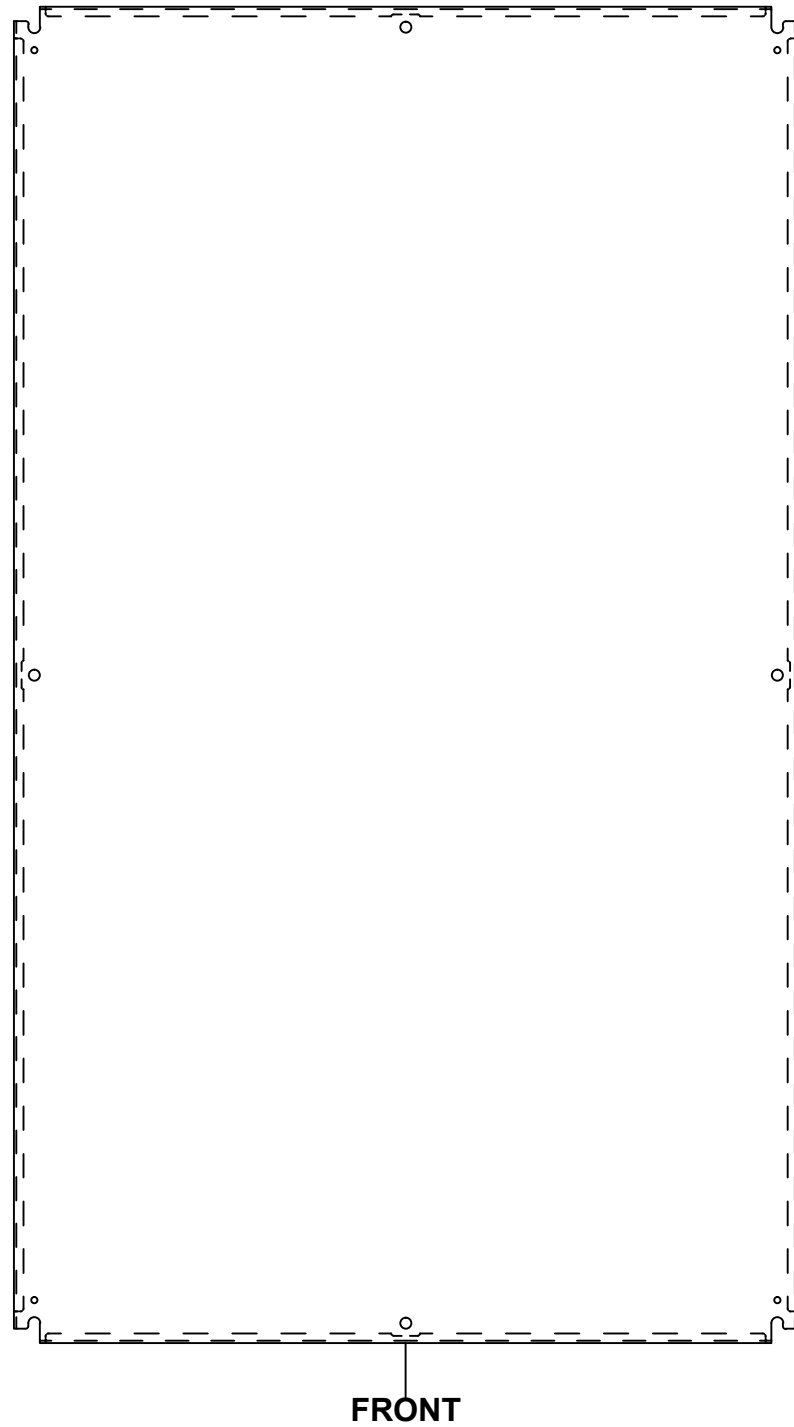
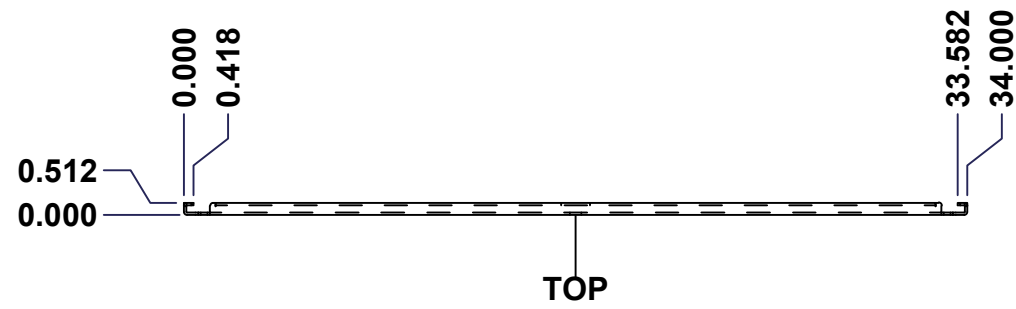

No.	Revisions	Date	By/Par

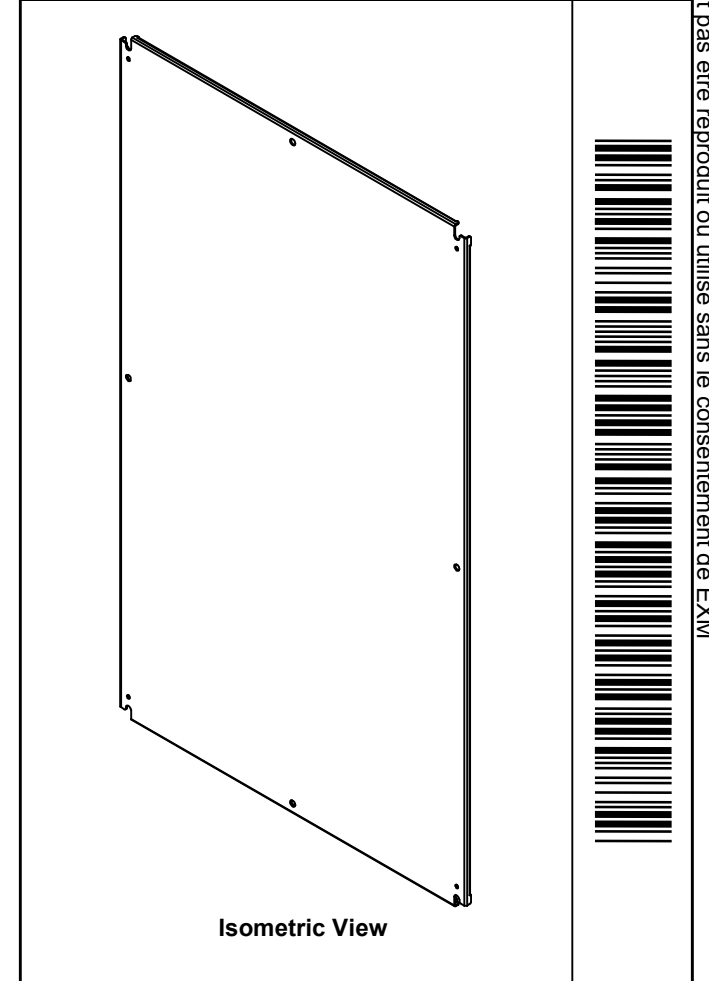

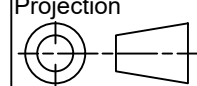
 Tél: (450) 979-4373 Fax: (450) 979-4626 www.exmweb.com		Flatness Aplatissement Max 3.0mm Projection 
Customer Client	Date	
Drawn By Dessiné Par: BoxCad	Date: 23-Jan-07	
Material Matière	See Part List	
Color Couleur	See Part List	Finish Fini: See Part List
Description: 881 SP - Inner Panel		Detail Rev.
Part Number Numéro Pièce: 881 SP6036G	Rev. 0	1 2

Qty	Part Number	Rev	Description	Material	Color	Finish
1	881 SP6036G-P	0	881 SP - Inner Panel Part	12 Ga Galvanized	Unpainted	Galvanized

Parts List

This drawing is confidential and must not be reproduced or used without the consent of EXM

Ce dessin est confidentiel et ne doit pas être reproduit ou utilisé sans le consentement de EXM

Table 1			FRONT VIEW
CUT-OUT	XDIM	YDIM	DESCRIPTION
1	17.000	0.875	MTG STUD HOLE (RND Ø0.500)
2	0.875	29.000	MTG STUD HOLE (RND Ø0.500)
3	33.125	29.000	MTG STUD HOLE (RND Ø0.500)
4	17.000	57.125	MTG STUD HOLE (RND Ø0.500)
5	0.875	1.875	GROUND HOLE (RND Ø0.290)
6	33.125	1.875	GROUND HOLE (RND Ø0.290)
7	0.875	56.125	GROUND HOLE (RND Ø0.290)
8	33.125	56.125	GROUND HOLE (RND Ø0.290)

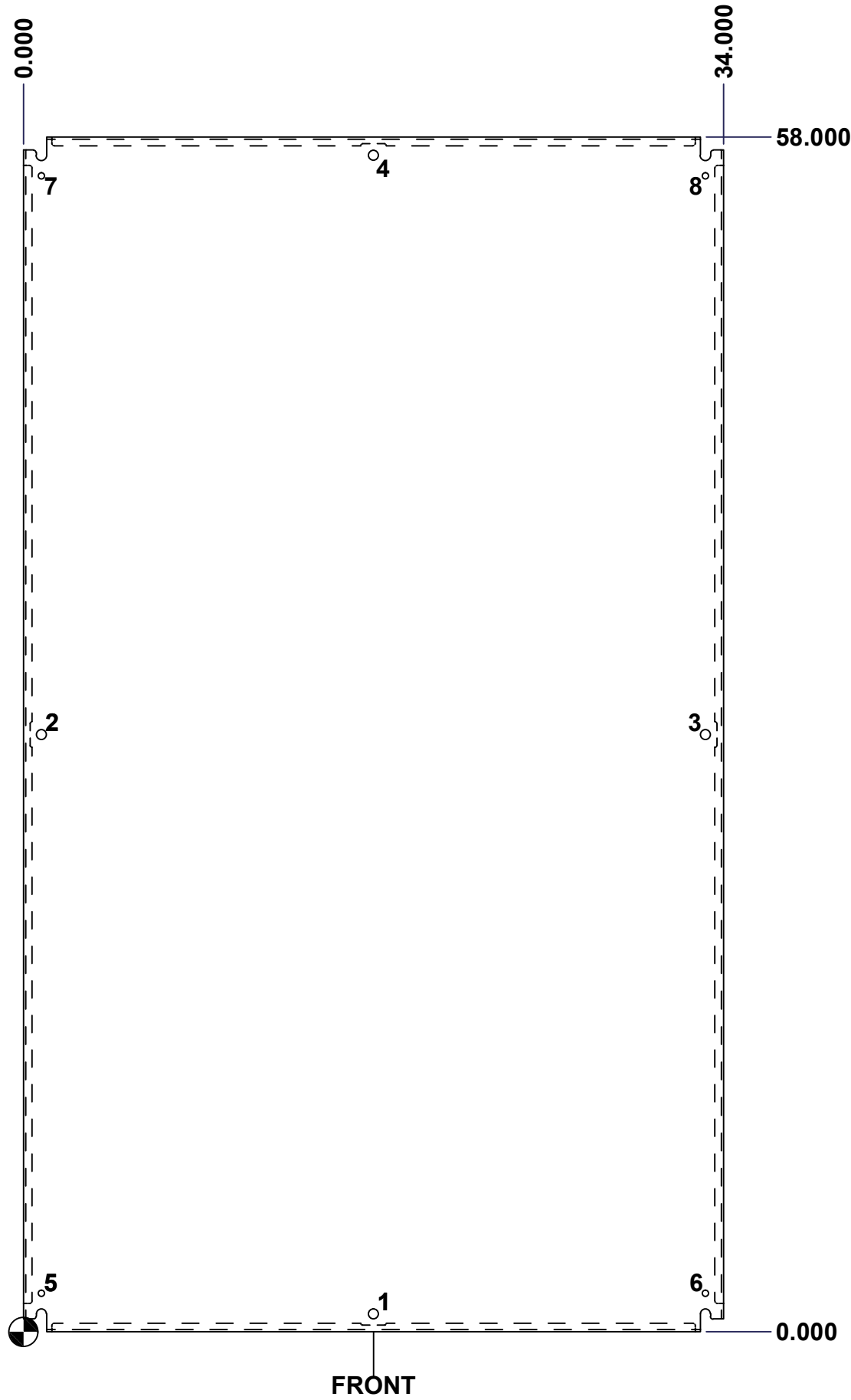

All knockouts are actual size / Les disques défonçables sont grandeur réel

No.	Revisions	Date	By/Par

Isometric View

		Tél: (450) 979-4373 Fax: (450) 979-4626 www.exmweb.com		Flatness Aplatissement Max 3.0mm	
Customer Client		Date		Projection 	
Drawn By Dessiné Par BoxCad		Date 23-Jan-07		Material Matière See Part List	
Color Couleur See Part List		Finish Fini See Part List		Description 881 SP - Inner Panel	
Part Number Numéro Pièce 881 SP6036G		Rev. 0		Detail Rev. 2 / 2	