

This drawing is confidential and must not be reproduced or used without the consent of EXM

Ce dessin est confidentiel et ne doit pas être reproduit ou utilisé sans le consentement de EXM

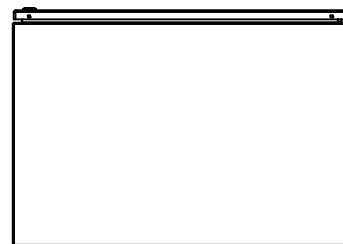

TOP



BACK

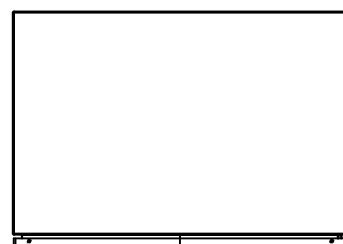

BOTTOM

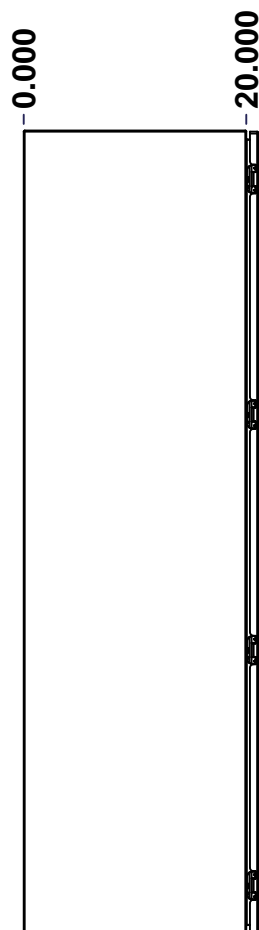

LEFT

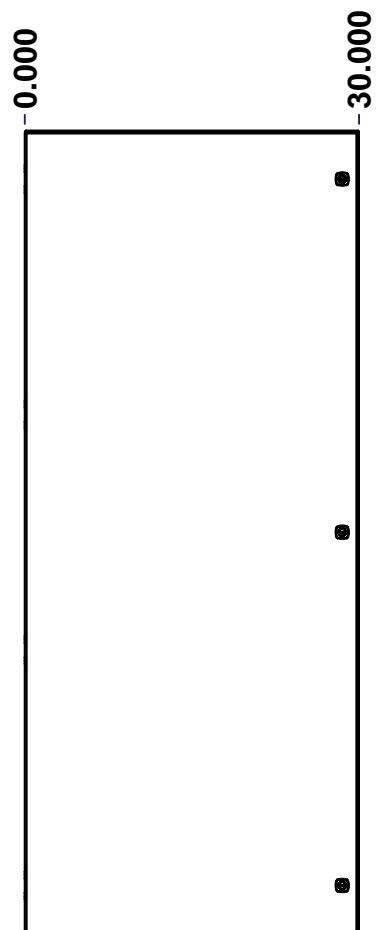

FRONT

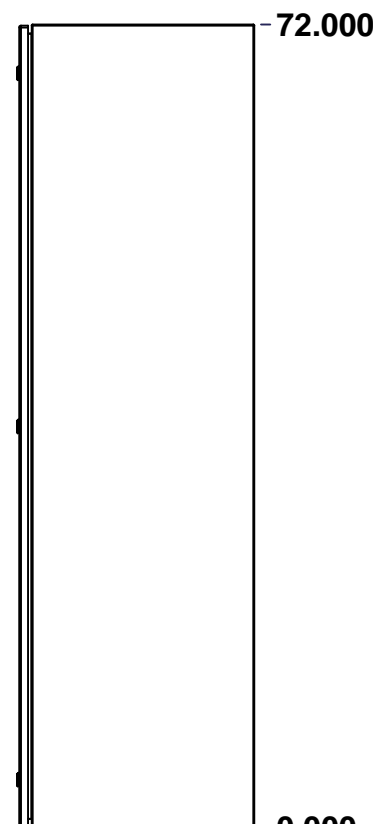

RIGHT

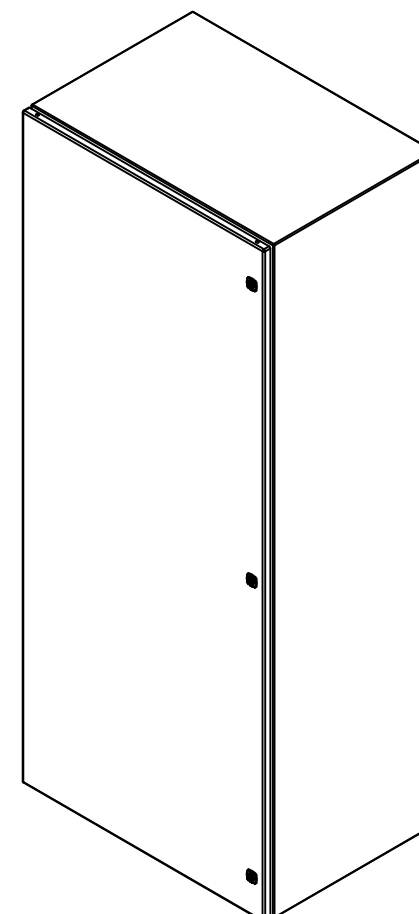

Isometric View

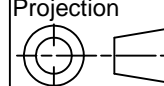

No.	Revisions	Date	By/Par

 Tél: (450) 979-4373 Fax: (450) 979-4626 <a href="http://www.exmweb.com">www.exmweb.com</a>		Flatness Aplatissement Max 3.0mm Projection 
Customer Client	Date	
Drawn By Dessiné Par	BoxCad: BoxCad	Date 23-Aug-13
Material Matière	14 Ga Stainless Steel 304 (1.7mm)	
Color Couleur	Asa-61 Grey	Finish Fini Smooth
Description	Detail Rev.	
5412ESSP 72" x 30" x 20" Assembly		
Part Number Numéro Pièce	Rev.	1
<b>5412ESSP723020</b>	<b>0</b>	2

SEE BILL OF MATERIAL ON LAST PAGE

This drawing is confidential and must not be reproduced or used without the consent of EXM

Ce dessin est confidentiel et ne doit pas être reproduit ou utilisé sans le consentement de EXM

NOTE	
ITEM	DESCRIPTION
1	NEMA 4X Enclosure
2	C/W Standard ground studs on box and cover
3	C/W Standard door stiffener
4	C/W Standard inner panel (Included)
5	C/W Standard inner panel mounting studs

No.	Revisions	Date	By/Par

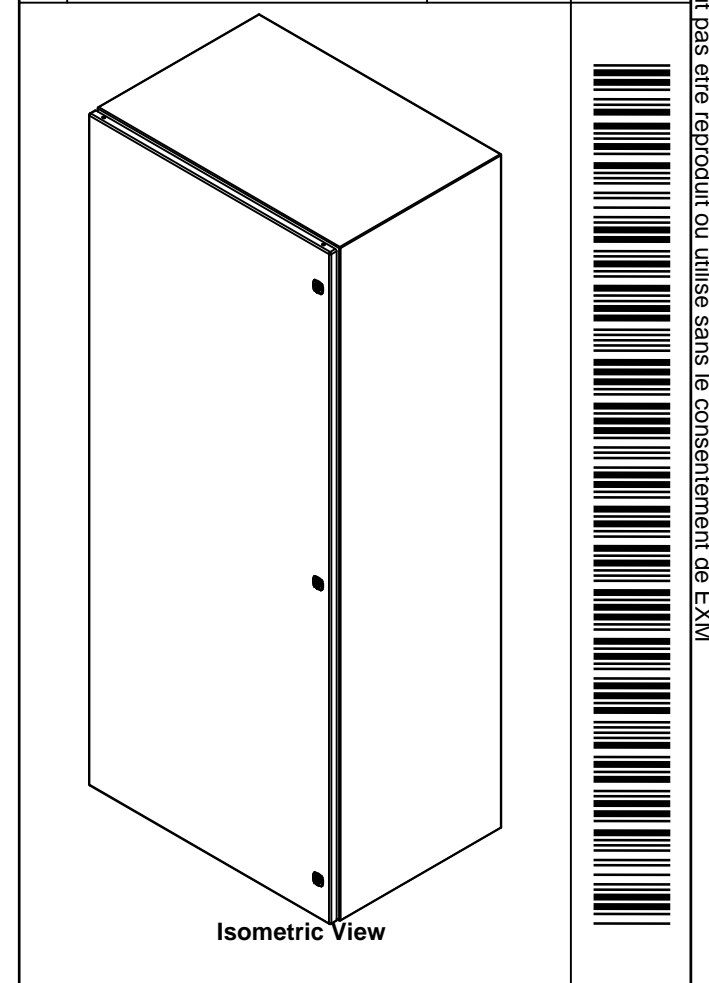

**EXM**  
www.exm.com

Tél: (450) 979-4373  
Fax: (450) 979-4626  
[www.exmweb.com](http://www.exmweb.com)

Flatness  
Aplatissement  
Max 3.0mm

Projection

PACKING		
ITEM	QTY	DESCRIPTION
Cardboard sleeve	2	Top and Bottom
Cardboard strip	2	Between back of enclosure and inner panel
Plastic bag	1	To protect cover surface and inside gasket
Cardboard corner	4	To reinforced for the plastic strap tightening
Plastic strap - Black	2	To Squeeze the 2 cardboard sleeve together
Packaging label	3	White label with PN
Plastic strap- Green	2	To secure the enclosure to the wood pallet
Wood Pallet	1	2" deeper and 3" larger than enclosure size

1	880 PP	6	Self Adhesive Print Pocket
1	STK-K-01800	5	5412 ES Accessory Kit
1	881 SP7230G	0	881 SP - Inner Panel
1	5412ESSP723020C	0	5412ESSP 72" x 30" Cover
6	STK-Q-07310	2	Flange Lock Nut M8
6	STK-Q-07610	8	M8 Plastic Spacer 22.2mm
1	5412ESSP723020B	0	5412ESSP 72" x 30" x 20" Body
4	STK-Q-04051-07	8	M6 x 7mm Stainless Steel Hexagon Socket Head Machine Screw with Nyseal
Qty	Part Number	Rev	Description
Parts List			

Customer Client

Drawn By  
Dessiné Par BoxCad: BoxCad

Material  
Matière 14 Ga Stainless Steel 304 (1.7mm)

Color  
Couleur Asa-61 Grey

Finish  
Fini Smooth

Description  
5412ESSP 72" x 30" x 20" Assembly

Part Number  
Numéro Pièce **5412ESSP723020**

Date 23-Aug-13

Detail Rev.

Rev.	2
	0
	2

This drawing is confidential and must not be reproduced or used without the consent of EXM

Ce dessin est confidentiel et ne doit pas être reproduit ou utilisé sans le consentement de EXM

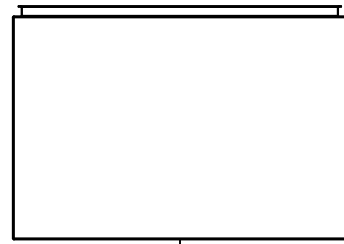

TOP

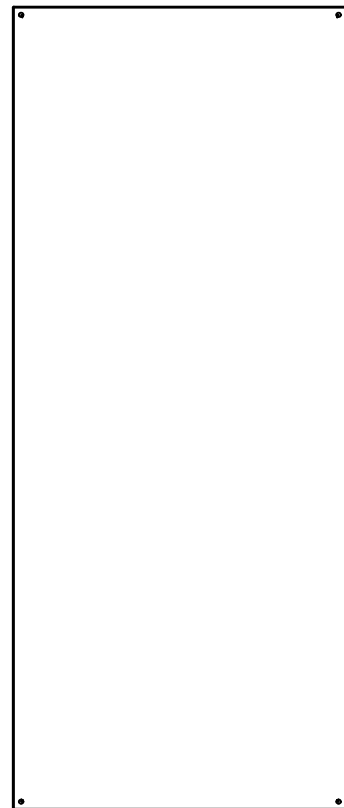

BACK

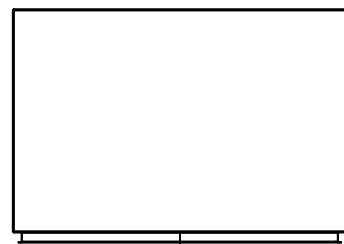

BOTTOM

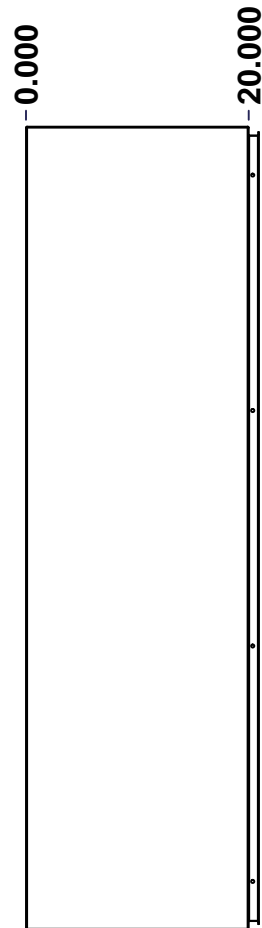

LEFT

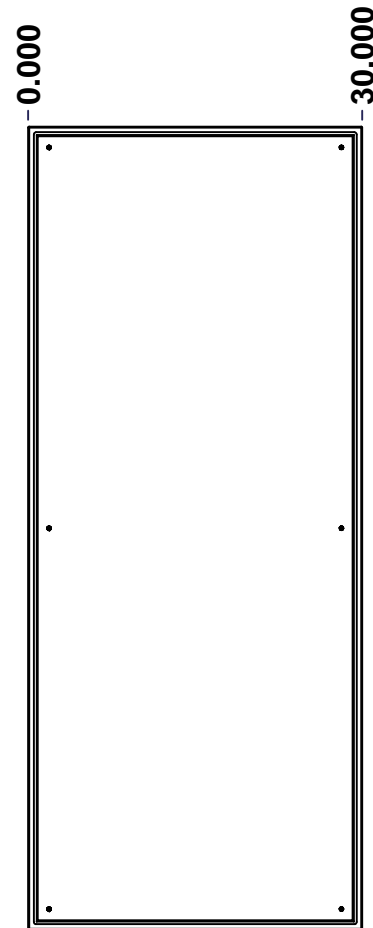

FRONT

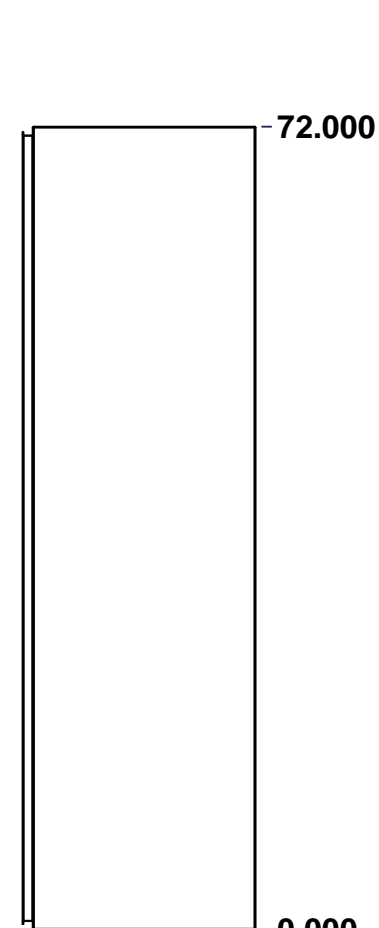

RIGHT

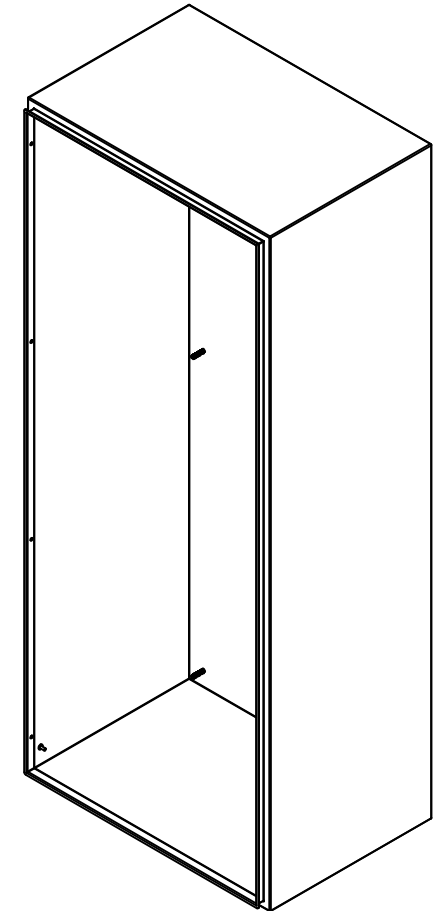

Isometric View

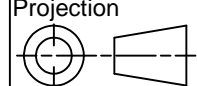

No.	Revisions	Date	By/Par

 Tél: (450) 979-4373 Fax: (450) 979-4626 <a href="http://www.exmweb.com">www.exmweb.com</a>		Flatness Aplatissement Max 3.0mm Projection 
Customer Client	Date	
Drawn By Dessiné Par	BoxCad: BoxCad	Date 23-Aug-13
Material Matière	14 Ga Stainless Steel 304 (1.7mm)	
Color Couleur	Asa-61 Grey	Finish Fini Smooth
Description	Detail Rev.	
5412ESSP 72" x 30" x 20" Body		
Part Number Numéro Pièce	Rev.	1 7
<b>5412ESSP723020B</b>	<b>0</b>	

SEE BILL OF MATERIAL ON LAST PAGE

This drawing is confidential and must not be reproduced or used without the consent of EXM

Ce dessin est confidentiel et ne doit pas être reproduit ou utilisé sans le consentement de EXM

**STANDARD FEATURES ARE NOT LISTED IN THIS HOLE TABLE**

**HOLE TABLE - LEFT VIEW (CUSTOM FEATURE ONLY)**

CUT-OUT	XDIM	YDIM	DESCRIPTION
1	18.500	2.000	GND STUD M6 x 16mm (Inside)

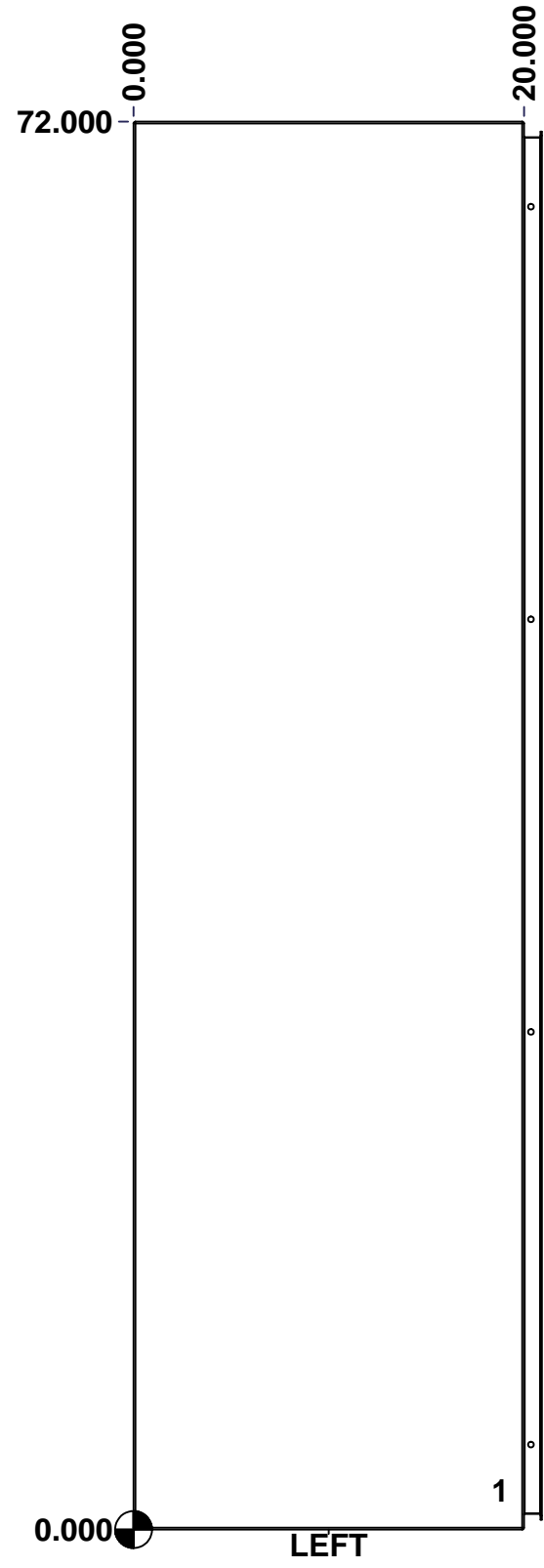

	Description	Status	
	5412ESSP 72" x 30" x 20" Body		
	Part Number Numéro Pièce	Rev.	5 7
	<b>5412ESSP723020B</b>	<b>0</b>	

This drawing is confidential and must not be reproduced or used without the consent of EXM

Ce dessin est confidentiel et ne doit pas être reproduit ou utilisé sans le consentement de EXM

**STANDARD FEATURES ARE NOT LISTED IN THIS HOLE TABLE**

**HOLE TABLE - BACK VIEW (CUSTOM FEATURE ONLY)**

CUT-OUT	XDIM	YDIM	DESCRIPTION
1	1.875	1.875	IP STUD M8 x 35mm (Inside)
2	1.875	70.125	IP STUD M8 x 35mm (Inside)
3	28.125	70.125	IP STUD M8 x 35mm (Inside)
4	28.125	1.875	IP STUD M8 x 35mm (Inside)
5	1.875	36.000	IP STUD M8 x 35mm (Inside)
6	28.125	36.000	IP STUD M8 x 35mm (Inside)
-----			
7	29.250	0.750	RND Ø0.390
8	29.250	71.250	RND Ø0.390
9	0.750	71.250	RND Ø0.390
10	0.750	0.750	RND Ø0.390

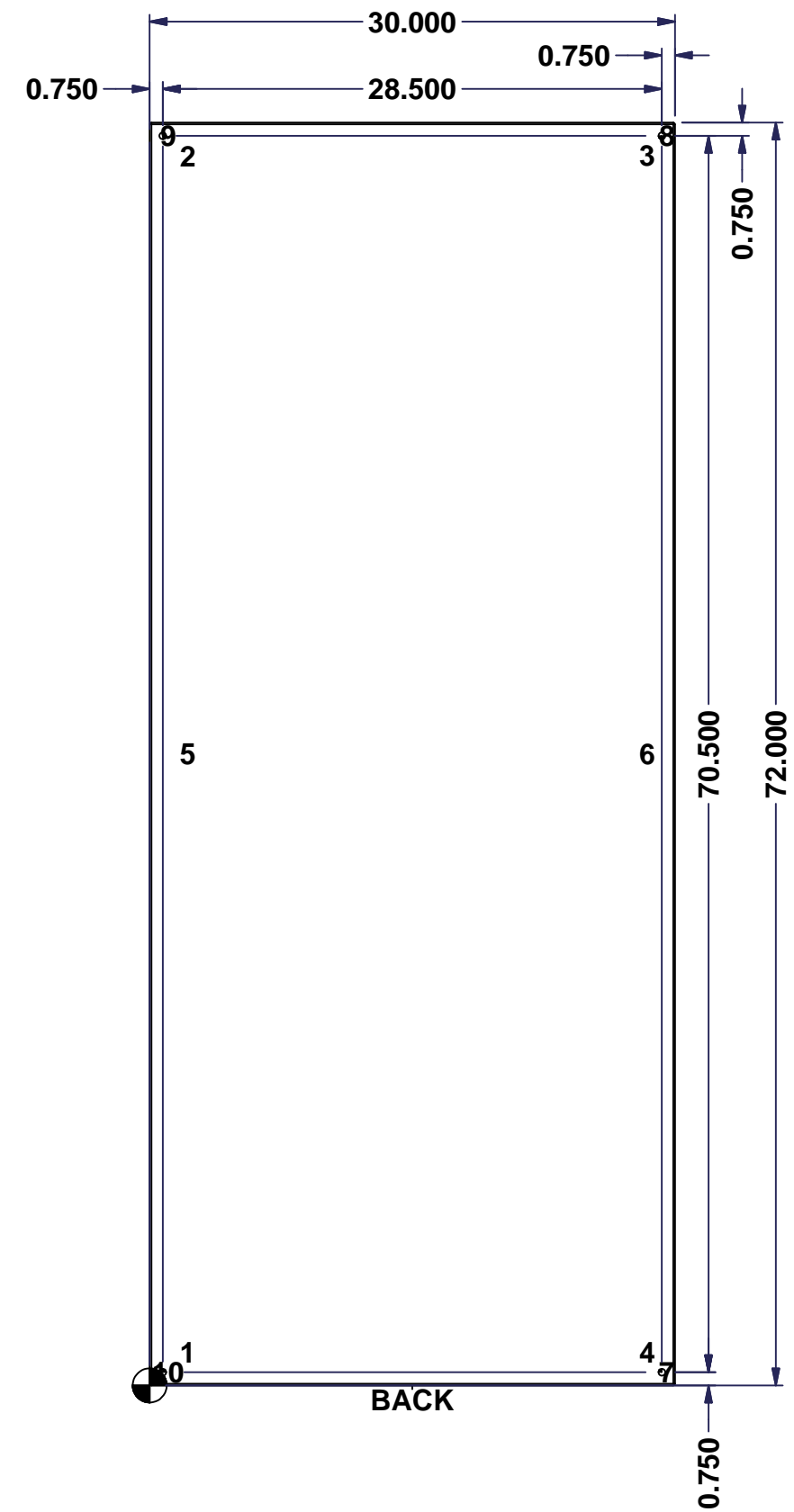

BACK

	Description	Status
	5412ESSP 72" x 30" x 20" Body	
	Part Number Numéro Pièce	Rev.
	<b>5412ESSP723020B</b>	<b>0</b>
		6 / 7

This drawing is confidential and must not be reproduced or used without the consent of EXM

Ce dessin est confidentiel et ne doit pas être reproduit ou utilisé sans le consentement de EXM

No.	Revisions	Date	By/Par

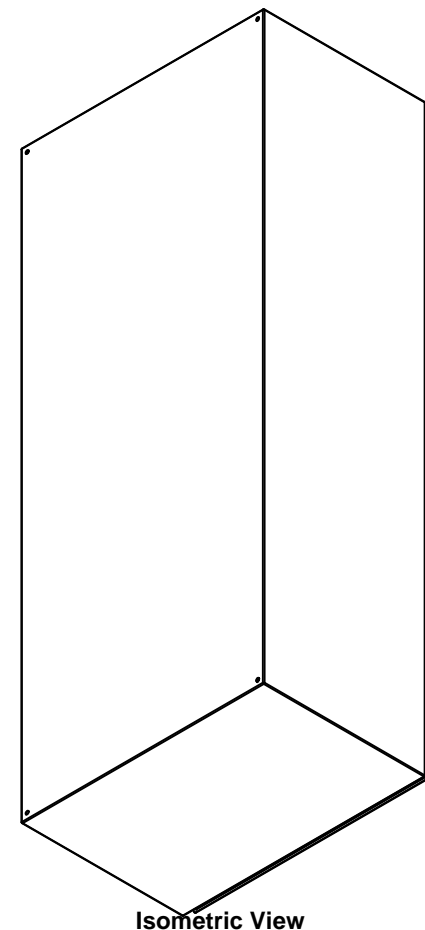

Isometric View



 Tél: (450) 979-4373 Fax: (450) 979-4626 <a href="http://www.exmweb.com">www.exmweb.com</a>	Flatness Aplatissement Max 3.0mm
	Projection 
Customer Client	Date
Drawn By Dessiné Par BoxCad: BoxCad	Date 23-Aug-13
Material Matière 14 Ga Stainless Steel 304 (1.7mm)	
Color Couleur Asa-61 Grey	Finish Fini Smooth
Description 5412ESSP 72" x 30" x 20" Body	
Part Number Numéro Pièce <b>5412ESSP723020B</b>	Detail Rev. Rev. 7 <b>0</b>

Qty	Part Number	Rev	Description
1	STK-Q-16085	0	Ground Stud M6 x 16mm Stainless Steel
1	STK-P-02400S	0	Powder Paint (Asa-61 Grey / Smooth)
6	STK-Q-16020	1	Stud M8 x 35mm Stainless Steel
1	5412ESSP723020B-P	0	5412ESSP 72" x 30" x 20" Body Part
Parts List			

This drawing is confidential and must not be reproduced or used without the consent of EXM

Ce dessin est confidentiel et ne doit pas être reproduit ou utilisé sans le consentement de EXM

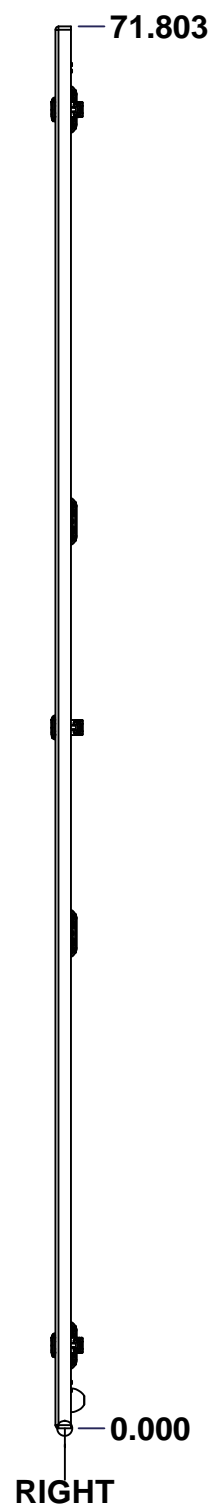
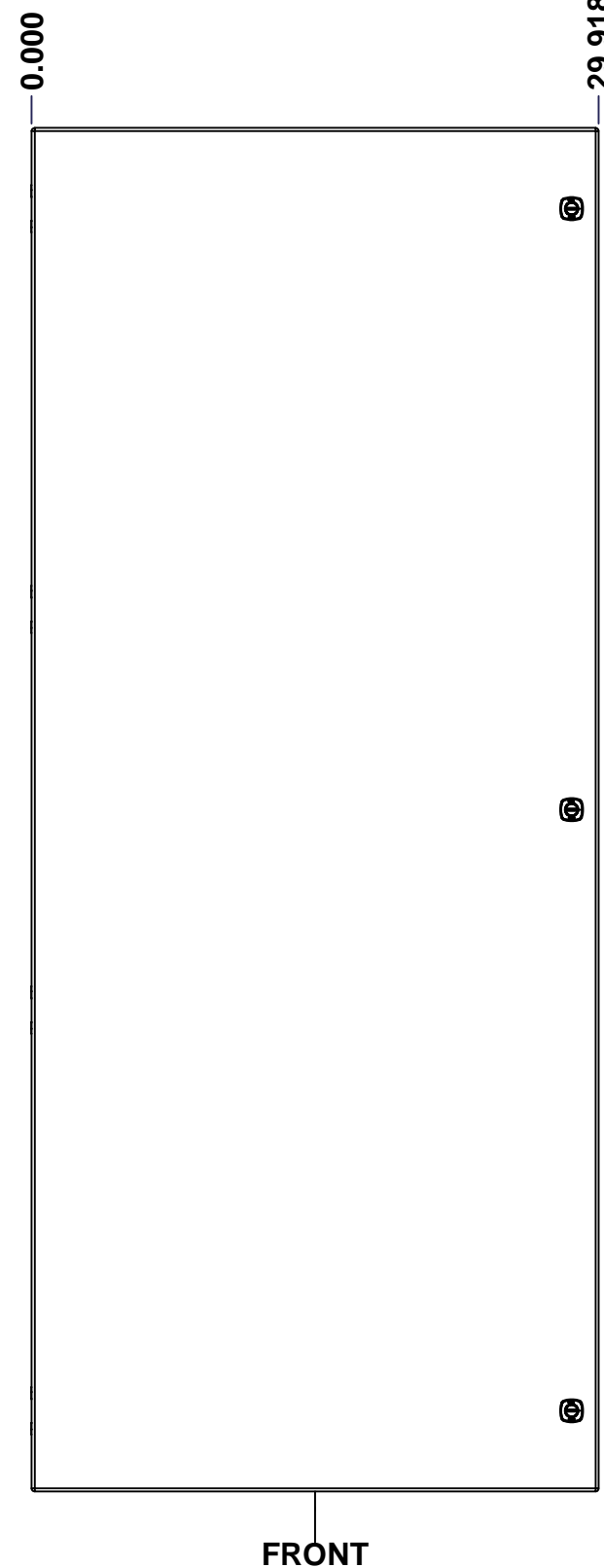
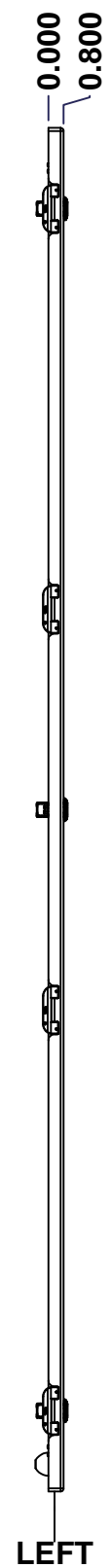
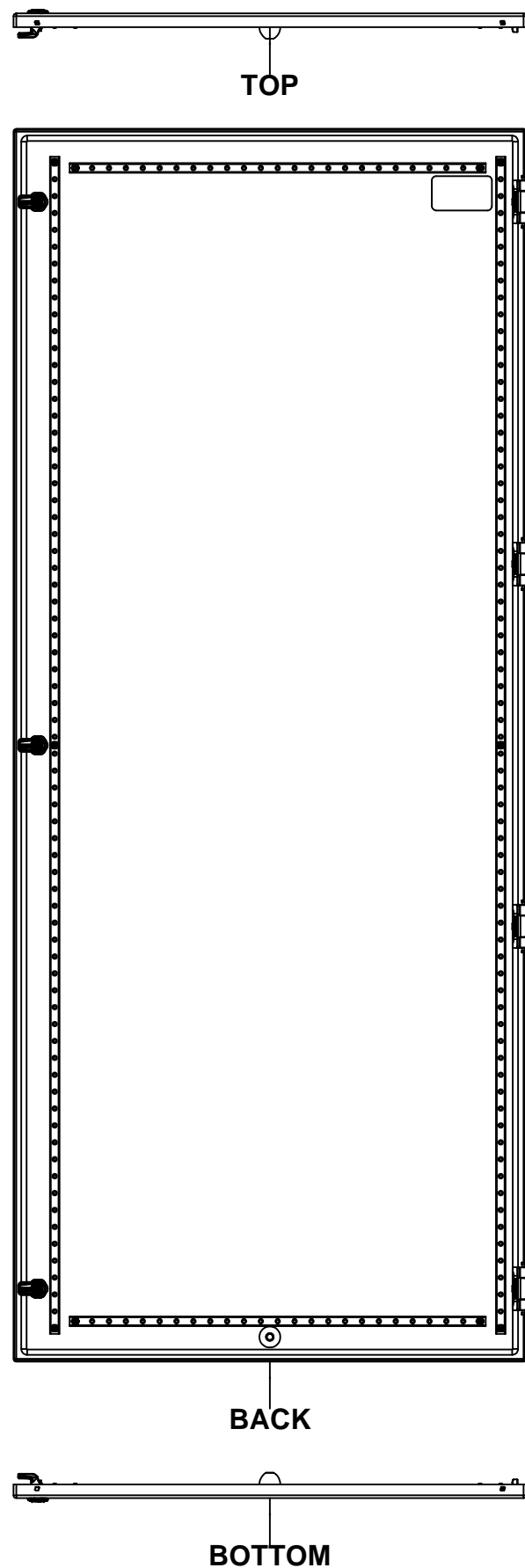

No.	Revisions	Date	By/Par

Isometric View

<p>Tél: (450) 979-4373 Fax: (450) 979-4626 <a href="http://www.exmweb.com">www.exmweb.com</a></p>		<p>Flatness Aplatissement Max 3.0mm</p> <p>Projection</p>
Customer Client	Date	
Drawn By Dessiné Par	BoxCad: BoxCad	Date 23-Aug-13
Material Matière	14 Ga Stainless Steel 304 (1.7mm)	
Color Couleur	Asa-61 Grey	Finish Fini Smooth
Description	Detail Rev.	
5412ESSP 72" x 30" Cover		
Part Number Numéro Pièce	Rev. 0	1 / 3
<b>5412ESSP723020C</b>		

SEE BILL OF MATERIAL ON LAST PAGE

This drawing is confidential and must not be reproduced or used without the consent of EXM

Ce dessin est confidentiel et ne doit pas être reproduit ou utilisé sans le consentement de EXM

**STANDARD FEATURES ARE NOT LISTED IN THIS HOLE TABLE**

**HOLE TABLE - FRONT VIEW (CUSTOM FEATURE ONLY)**

CUT-OUT	XDIM	YDIM	DESCRIPTION
1	1.486	1.945	STUD M6 x 18mm (Inside)
2	1.486	69.858	STUD M6 x 18mm (Inside)
3	27.517	69.858	STUD M6 x 18mm (Inside)
4	27.517	1.945	STUD M6 x 18mm (Inside)
5	1.486	35.902	STUD M6 x 18mm (Inside)
6	27.517	35.902	STUD M6 x 18mm (Inside)
7	2.690	2.350	STUD M6 x 18mm (Inside)
8	2.690	69.524	STUD M6 x 18mm (Inside)
9	26.313	69.524	STUD M6 x 18mm (Inside)
10	26.313	2.350	STUD M6 x 18mm (Inside)
11	14.959	1.435	STUD M6 x 18mm (Inside)
-----			
12	3.750	68.053	LABEL_EXM (Inside)
13	28.494	67.553	LOCK 880 SCQ4-SLSS6 @ 0.0°
14	28.494	35.902	LOCK 880 SCQ4-SLSS6 @ 0.0°
15	28.494	4.250	LOCK 880 SCQ4-SLSS6 @ 0.0°

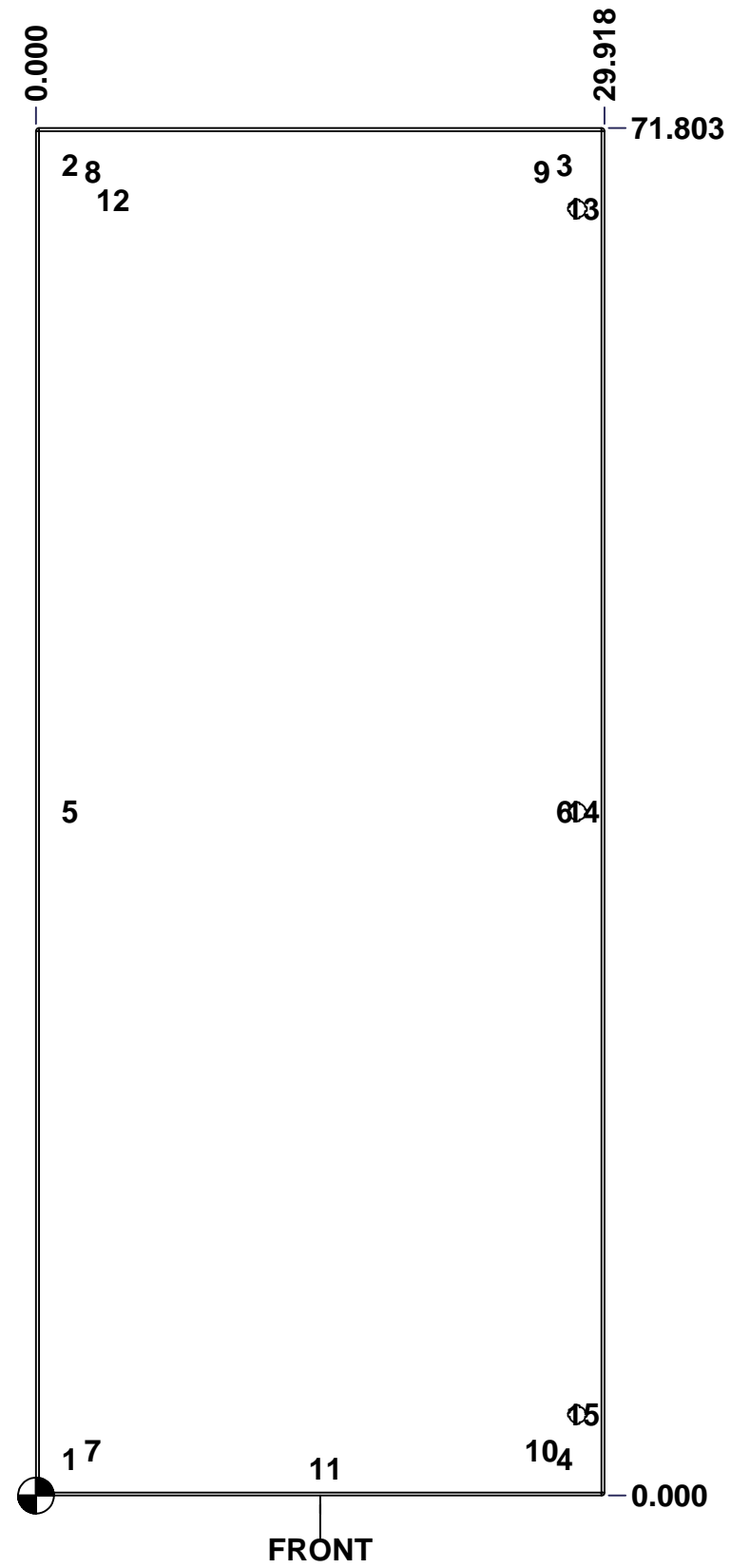

	Description	Status	
	5412ESSP 72" x 30" Cover	(NULL)	
	Part Number Numéro Pièce	Rev.	
	<b>5412ESSP723020C</b>	<b>0</b>	2 3



This drawing is confidential and must not be reproduced or used without the consent of EXM

Ce dessin est confidentiel et ne doit pas être reproduit ou utilisé sans le consentement de EXM

No.	Revisions	Date	By/Par

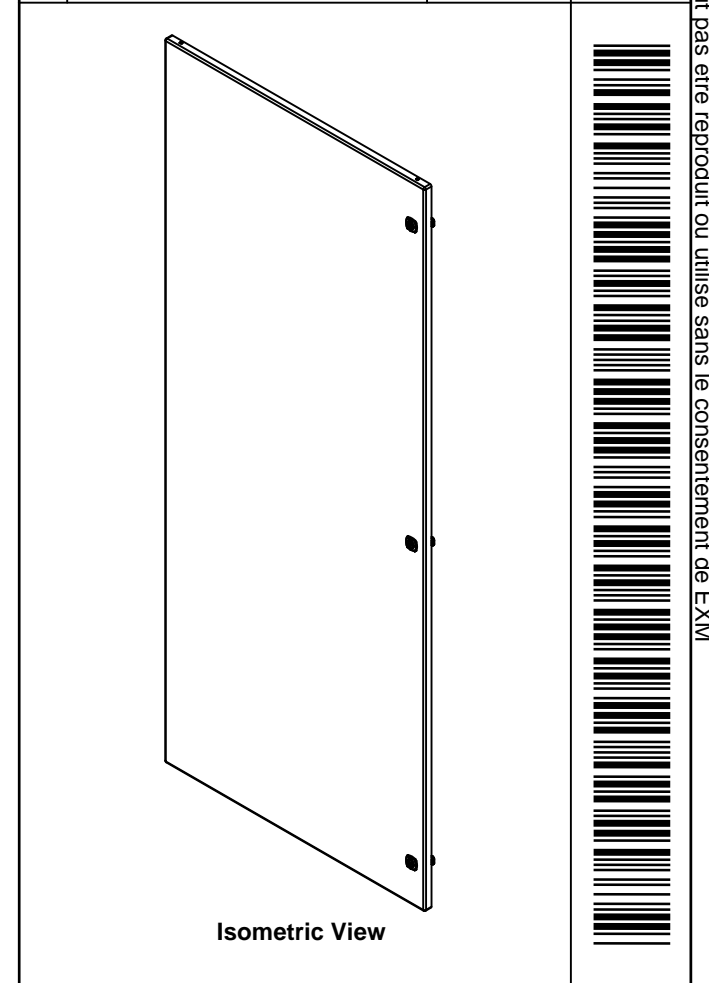

Tél: (450) 979-4373 Fax: (450) 979-4626 <a href="http://www.exmweb.com">www.exmweb.com</a>		Flatness Aplatissement
		Max 3.0mm
Projection		
Customer Client	Date	
Drawn By Dessiné Par	BoxCad: BoxCad	Date 23-Aug-13
Material Matière	14 Ga Stainless Steel 304 (1.7mm)	
Color Couleur	Asa-61 Grey	Finish Fini Smooth
Description		Detail Rev.
5412ESSP 72" x 30" Cover		
Part Number Numéro Pièce	Rev. 3	3
<b>5412ESSP723020C</b>		<b>0</b>

1	STK-S-00100	0	3.5" x 2" Silver Milar Flexcon Sticker
1	STK-P-02400S	0	Powder Paint (Asa-61 Grey / Smooth)
1	STK-Q-46515	3	5412 ES Door Support with Brass Insert
2	STK-Q-46025-30-3	4	5412 ES Horizontal Door Stiffener 30" (3Pts)
2	STK-Q-46020-72	5	5412 ES Vertical Door Stiffener 72"
11	STK-Q-16070	1	Stud M6 x 18mm Stainless steel
1	5412ESSP723020G	0	5412ESSP 72" x 30" Cover Gasket Part
1	5412ESSP723020C-P	0	5412ESSP 72" x 30" Cover Part
4	STK-K-09850	6	5412 ESS Hinge with 2 Captive Hinge Pins
3	880 SCQ4-SLSS6	7	5412 ESS 1/4 Turn Lock
10	STK-Q-07220	1	M6 Nylon Insert Lock Nut
Qty	Part Name	Rev	Description
Parts List			

This drawing is confidential and must not be reproduced or used without the consent of EXM

Ce dessin est confidentiel et ne doit pas être reproduit ou utilisé sans le consentement de EXM

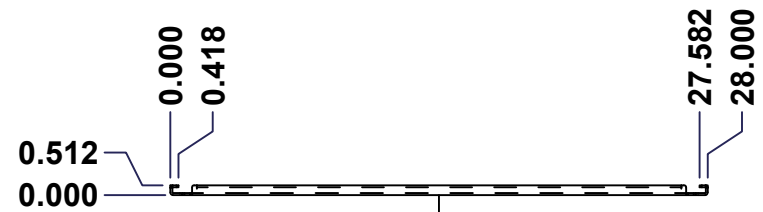

TOP

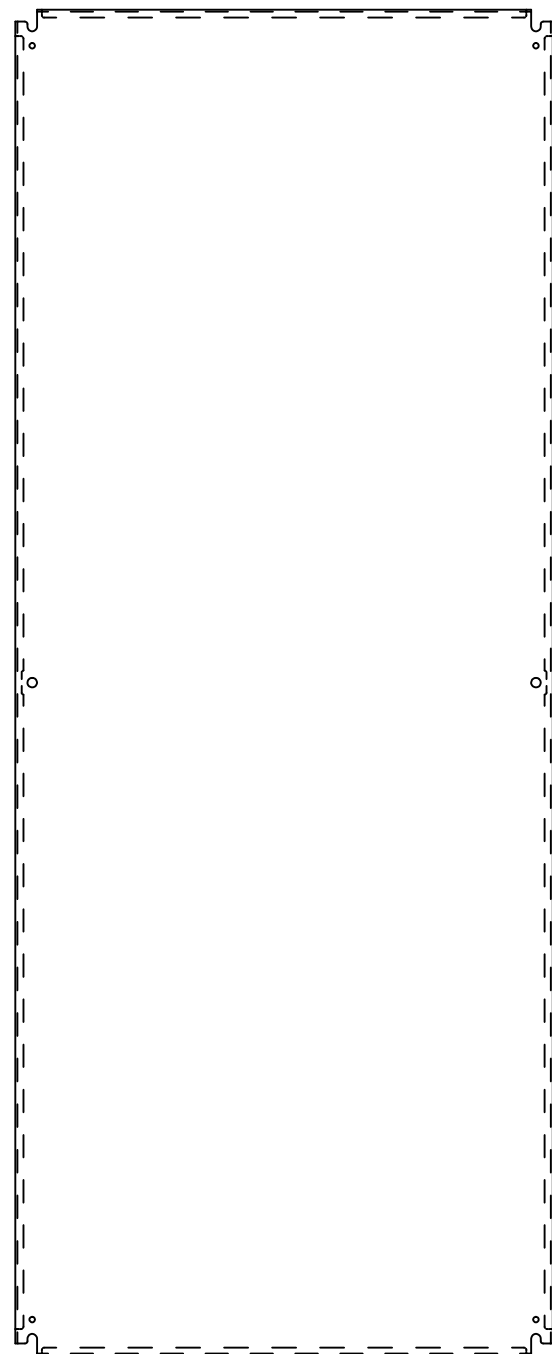

FRONT

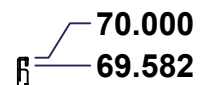

RIGHT

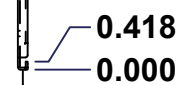

No.	Revisions	Date	By/Par

Isometric View

		Flatness Aplatissement Max 3.0mm	
Tél: (450) 979-4373 Fax: (450) 979-4626 www.exmweb.com		Projection 	
Customer Client		Date	
Drawn By / Dessiné Par: BoxCad		Date: 1/23/2007	
Material / Matière: See Part List			
Color / Couleur: See Part List		Finish / Fini: See Part List	
Description: 881 SP - Inner Panel			Detail Rev.
Part Number / Numéro Pièce: <b>881 SP7230G</b>			Rev. 1/2

Qty	Part Number	Rev	Description	Material	Color	Finish
1	881 SP7230G-P	0	881 SP - Inner Panel Part	12 Ga Galvanized	Unpainted	Galvanized

Parts List

This drawing is confidential and must not be reproduced or used without the consent of EXM

Ce dessin est confidentiel et ne doit pas être reproduit ou utilisé sans le consentement de EXM

Table 1			FRONT VIEW
CUT-OUT	XDIM	YDIM	DESCRIPTION
1	0.875	1.875	GROUND HOLE (RND Ø0.290)
2	27.125	1.875	GROUND HOLE (RND Ø0.290)
3	0.875	68.125	GROUND HOLE (RND Ø0.290)
4	27.125	68.125	GROUND HOLE (RND Ø0.290)
5	0.875	35.000	MTG STUD HOLE (RND Ø0.500)
6	27.125	35.000	MTG STUD HOLE (RND Ø0.500)

All knockouts are actual size / Les disques défonçables sont grandeur réel

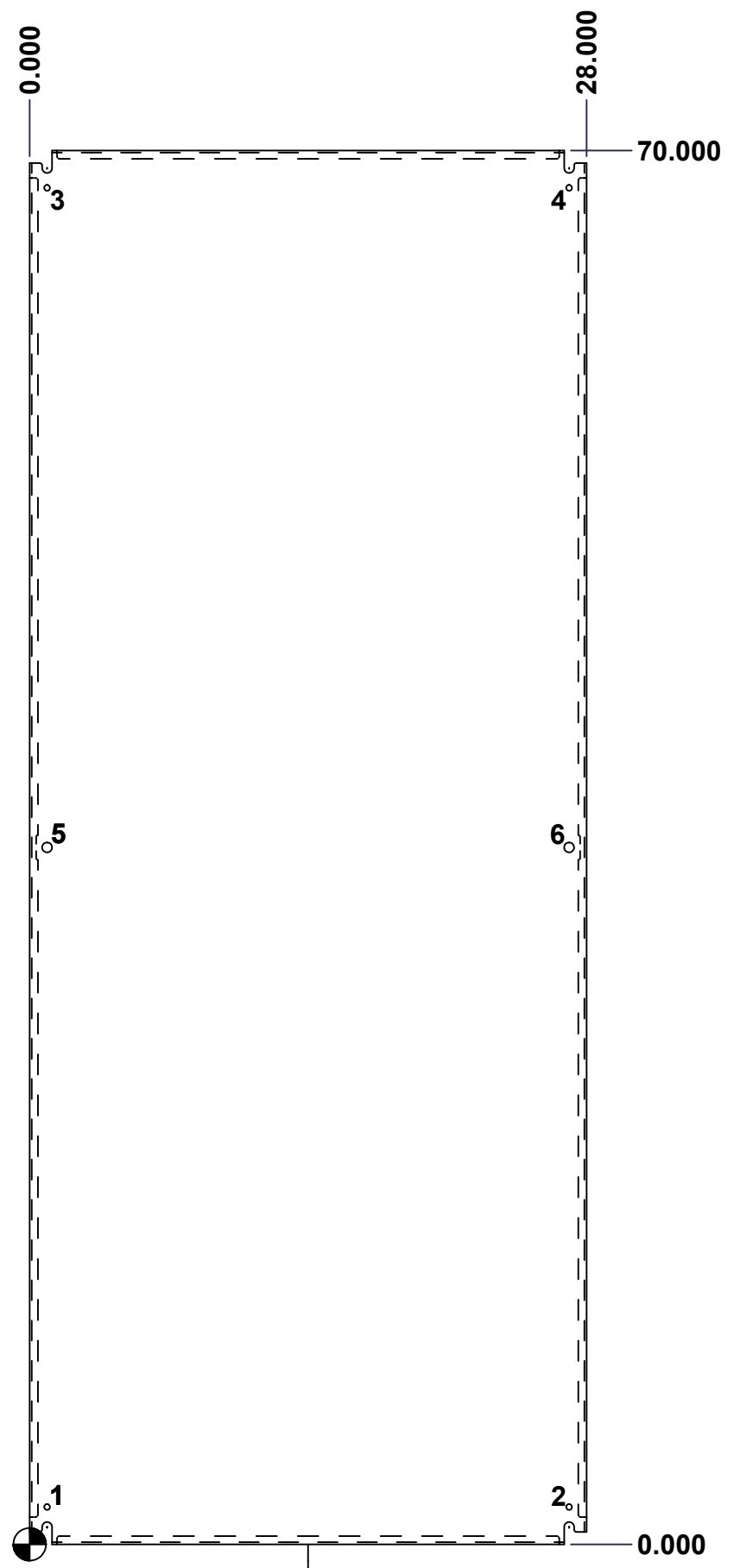

FRONT

No.	Revisions	Date	By/Par

Isometric View

		Tél: (450) 979-4373 Fax: (450) 979-4626 www.exmweb.com		Flatness Aplatissement Max 3.0mm
Customer Client		Date		Projection 
Drawn By Dessiné Par BoxCad		Date 1/23/2007		
Material Matière		See Part List		
Color Couleur		See Part List		Finish Fini See Part List
Description 881 SP - Inner Panel			Detail Rev.	
Part Number Numéro Pièce <b>881 SP7230G</b>			Rev.	2 0