

This drawing is confidential and must not be reproduced or used without the consent of EXM

Ce dessin est confidentiel et ne doit pas être reproduit ou utilisé sans le consentement de EXM

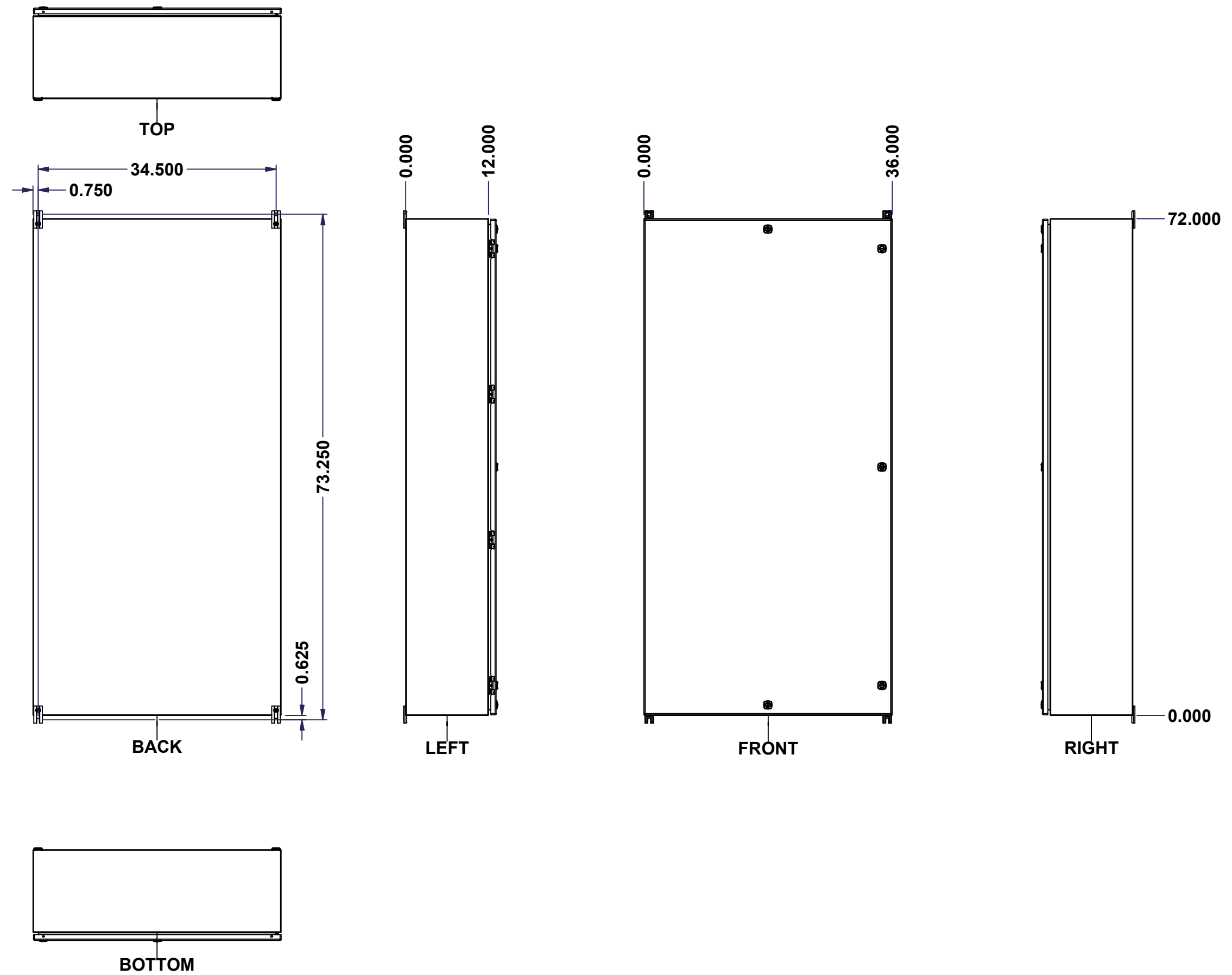

No.	Revisions	Date	By/Par

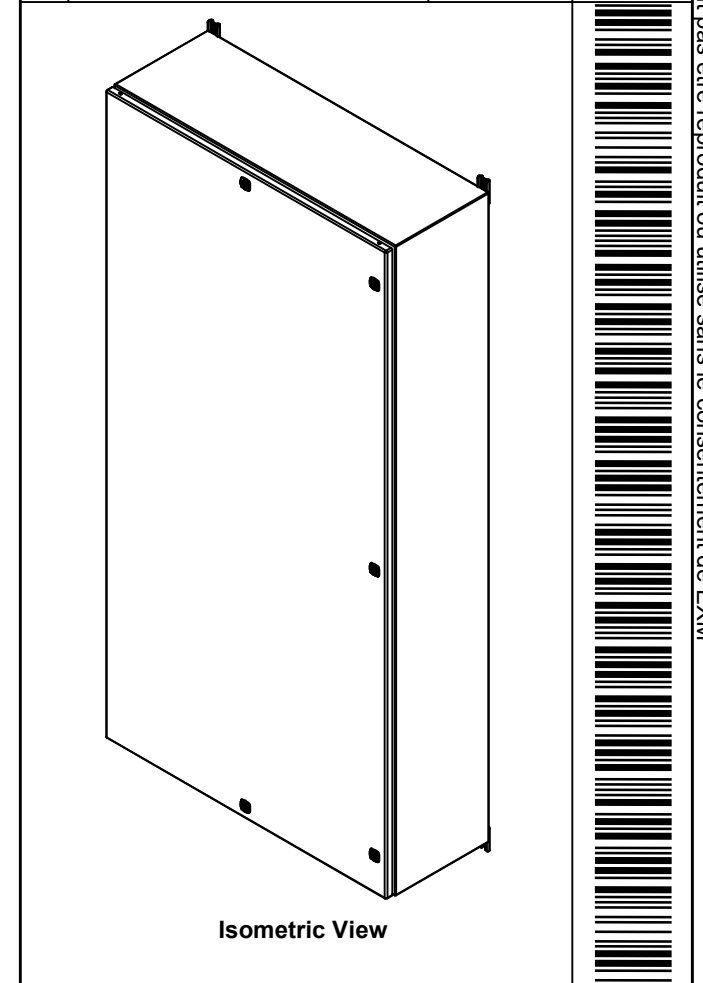

Tél: (450) 979-4373 Fax: (450) 979-4626 www.exmweb.com		Flatness Aplatissement Max 3.0mm Projection
Customer Client	Date	
Drawn By Dessiné Par	BoxCad: BoxCad	Date 13-Apr-23
Material Matière	14 Ga Stainless Steel 316 (1.7mm)	
Color Couleur	Asa-61 Grey	Finish Fini Smooth
Description	Detail Rev.	
5412ESSP 72" x 36" x 12" Assembly		
Part Number Numéro Pièce	Rev.	1
5412ESSP7236126TH	0	16

SEE BILL OF MATERIAL ON LAST PAGE

This drawing is confidential and must not be reproduced or used without the consent of EXM

Ce dessin est confidentiel et ne doit pas être reproduit ou utilisé sans le consentement de EXM

NOTE	
ITEM	DESCRIPTION
1	NEMA 4X Enclosure
2	C/W Standard ground studs on box and cover
3	C/W Standard door stiffener
4	C/W Standard inner panel (Included)
5	C/W Standard inner panel mounting studs
6	C/W 885 ESMF4_OPEN Sold separately (Installed)
7	C/W 885 ESMF4_CLOSE Sold separately (Installed)
8	C/W Special locks sold separately (Installed)
9	C/W R5 Insulation (Installed by EXM)

No.	Revisions	Date	By/Par

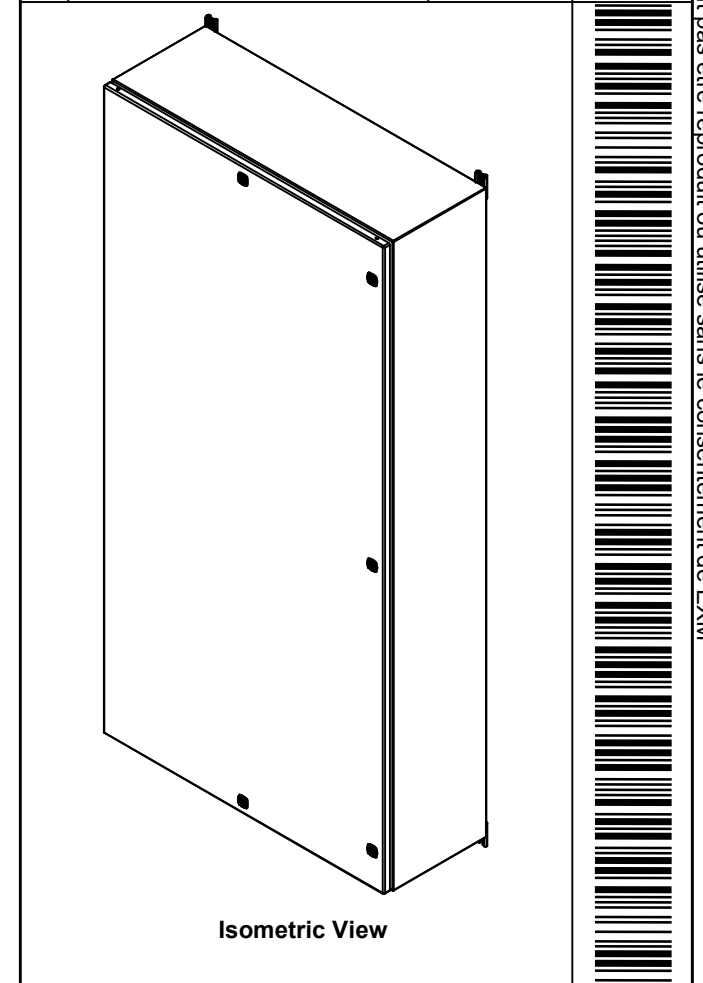

PACKING		
ITEM	QTY	DESCRIPTION
Cardboard sleeve	2	Top and Bottom
Cardboard strip	2	Between back of enclosure and inner panel
Plastic bag	1	To protect cover surface and inside gasket
Cardboard corner	4	To reinforced for the plastic strap tightening
Plastic strap - Black	2	To Squeeze the 2 cardboard sleeve together
Packaging label	3	White label with PN
Plastic strap- Green	2	To secure the enclosure to the wood pallet
Wood Pallet	1	2" deeper and 3" larger than enclosure size

8	STK-Q-00600	2	M12 to M8 Adaptor
1	881 SP7236G	0	881 SP - Inner Panel
1	STK-K-01800	5	5412 ES Accessory Kit
1	5412ESSP7236126THC	0	5412ESSP 72" x 36" Cover
1	5412ESSP7236126THB	0	5412ESSP 72" x 36" x 12" Body
4	STK-Q-04051-08	1	M6 x 8mm Stainless Steel Hexagon Socket Head Machine Screw with Nyseal
Qty	Part Number	Rev	Description
Parts List			



Tél: (450) 979-4373
Fax: (450) 979-4626
www.exmweb.com

Flatness
Aplatissement
Max 3.0mm

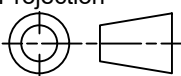
Projection

Customer Client	Date
Drawn By Dessiné Par	Date 13-Apr-23
Material Matière	14 Ga Stainless Steel 316 (1.7mm)
Color Couleur	Asa-61 Grey
Finish Fini	Smooth
Description	Detail Rev.
5412ESSP 72" x 36" x 12" Assembly	
Part Number Numéro Pièce	Rev. 2
5412ESSP7236126TH	0

This drawing is confidential and must not be reproduced or used without the consent of EXM

Ce dessin est confidentiel et ne doit pas être reproduit ou utilisé sans le consentement de EXM

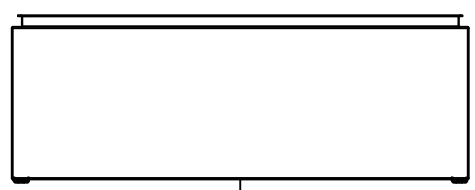

TOP

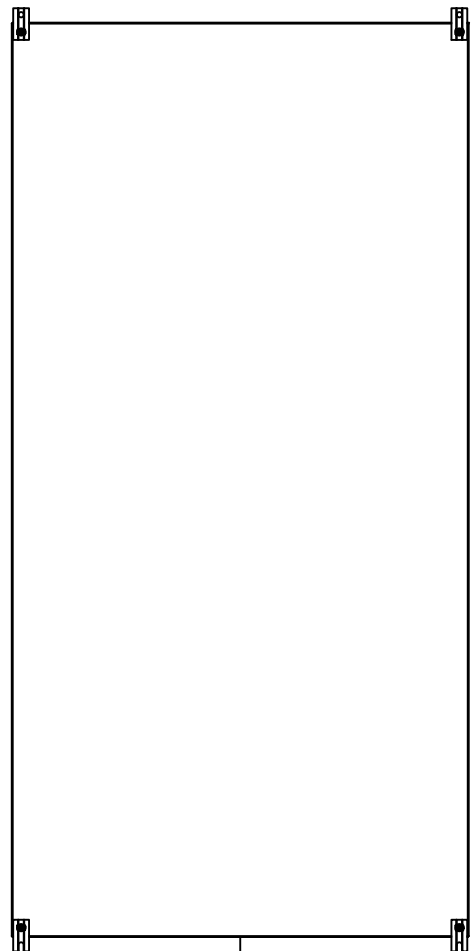

BACK

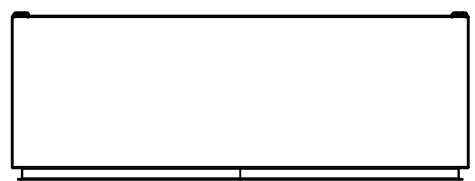

BOTTOM

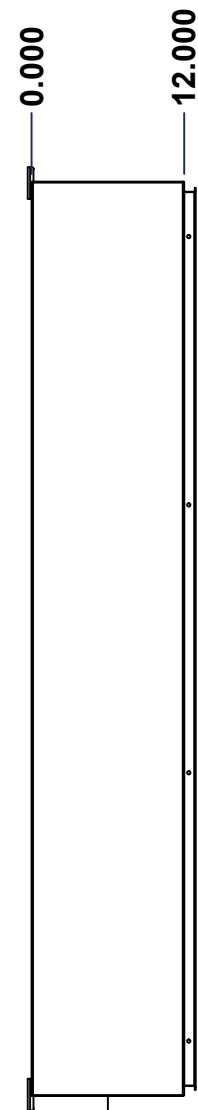

LEFT

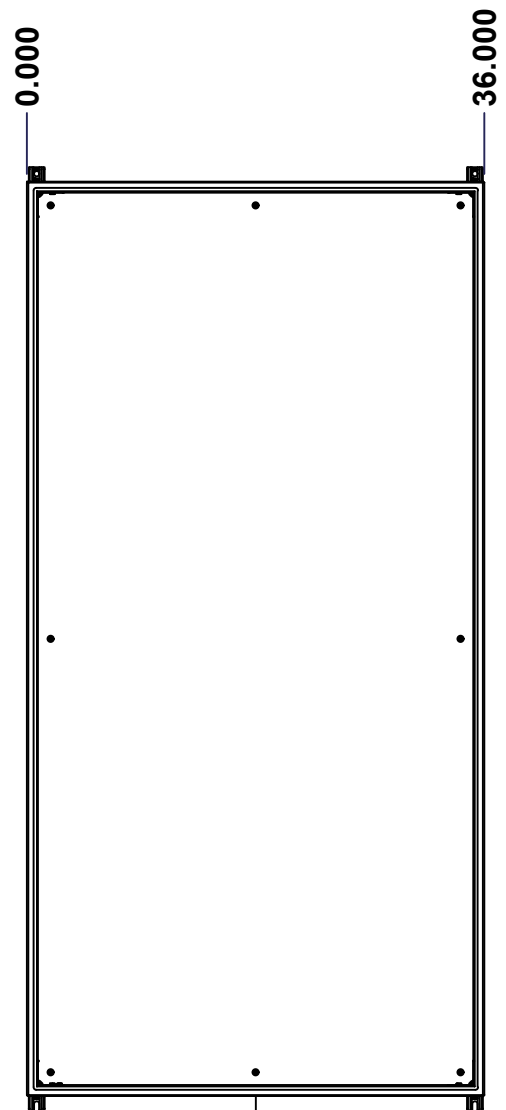

FRONT

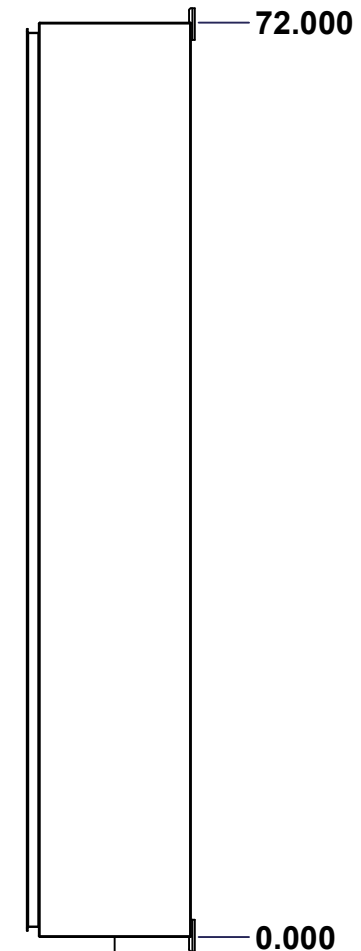

RIGHT

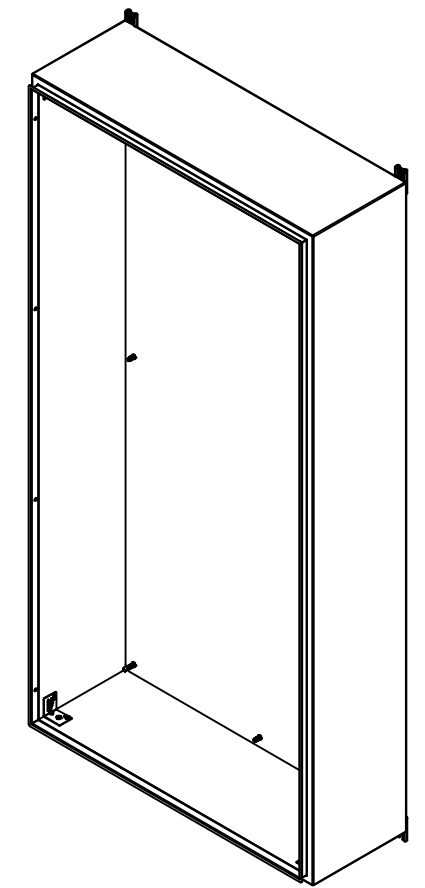

Isometric View



No.	Revisions	Date	By/Par

 Tél: (450) 979-4373 Fax: (450) 979-4626 www.exmweb.com		Flatness Aplatissement Max 3.0mm Projection 
Customer Client	Date	
Drawn By Dessiné Par	BoxCad: BoxCad	Date 13-Apr-23
Material Matière	14 Ga Stainless Steel 316 (1.7mm)	
Color Couleur	Asa-61 Grey	Finish Fini Smooth
Description	Detail Rev.	
5412ESSP 72" x 36" x 12" Body		
Part Number Numéro Pièce	Rev.	3
SEE BILL OF MATERIAL ON LAST PAGE	5412ESSP7236126THB	0

SEE BILL OF MATERIAL ON LAST PAGE

5412ESSP7236126THB

Rev. 0

This drawing is confidential and must not be reproduced or used without the consent of EXM

Ce dessin est confidentiel et ne doit pas être reproduit ou utilisé sans le consentement de EXM

STANDARD FEATURES ARE NOT LISTED IN THIS HOLE TABLE			
HOLE TABLE - TOP VIEW (CUSTOM FEATURE ONLY)			
CUT-OUT	XDIM	YDIM	DESCRIPTION
1	2.000	10.500	INSUL. STUD M6 x 18mm (Inside)
2	34.000	10.500	INSUL. STUD M6 x 18mm (Inside)

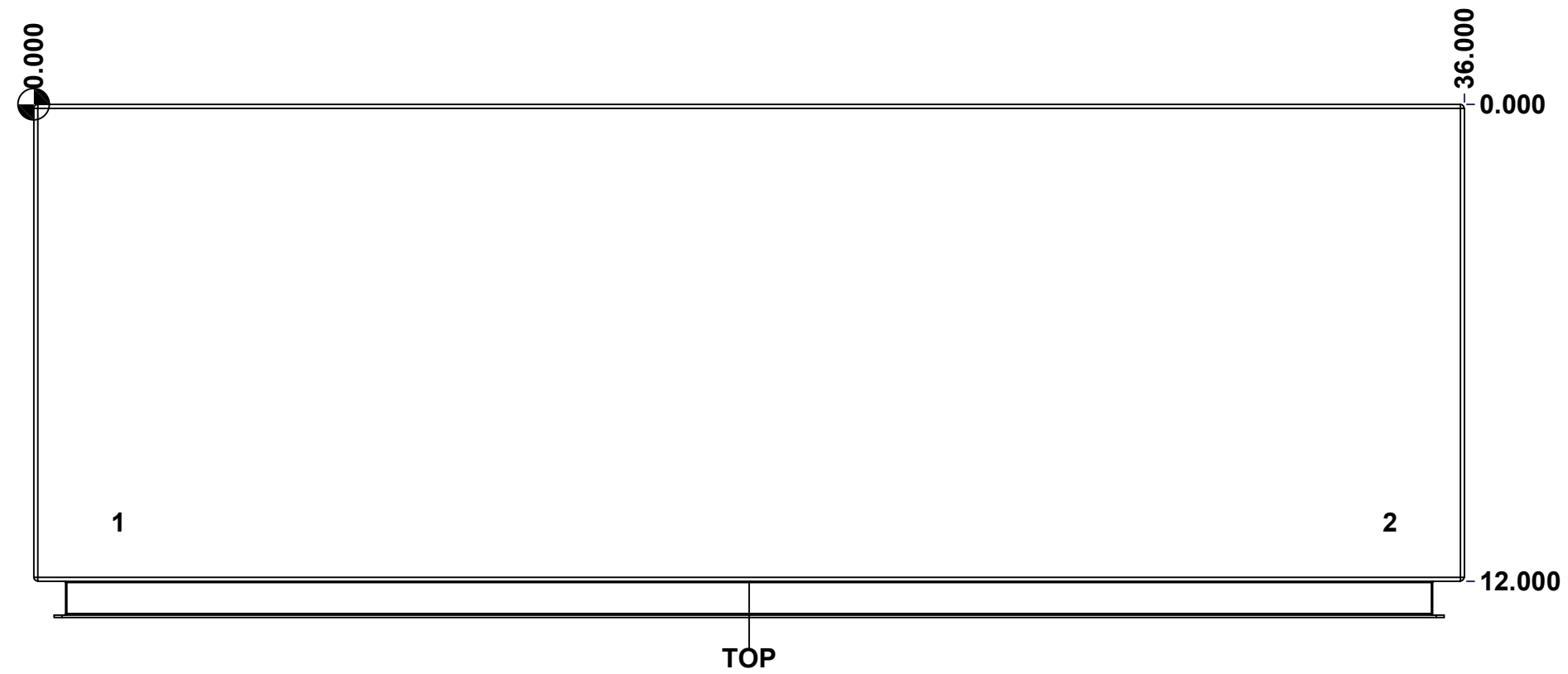

	Description	Status	
	5412ESSP 72" x 36" x 12" Body	(NULL)	
	Part Number Numéro Pièce	Rev.	4
	5412ESSP7236126THB	0	16

This drawing is confidential and must not be reproduced or used without the consent of EXM

Ce dessin est confidentiel et ne doit pas être reproduit ou utilisé sans le consentement de EXM

STANDARD FEATURES ARE NOT LISTED IN THIS HOLE TABLE			
HOLE TABLE - BOTTOM VIEW (CUSTOM FEATURE ONLY)			
CUT-OUT	XDIM	YDIM	DESCRIPTION
1	2.000	10.500	INSUL. STUD M6 x 18mm (Inside)
2	34.000	10.500	INSUL. STUD M6 x 18mm (Inside)

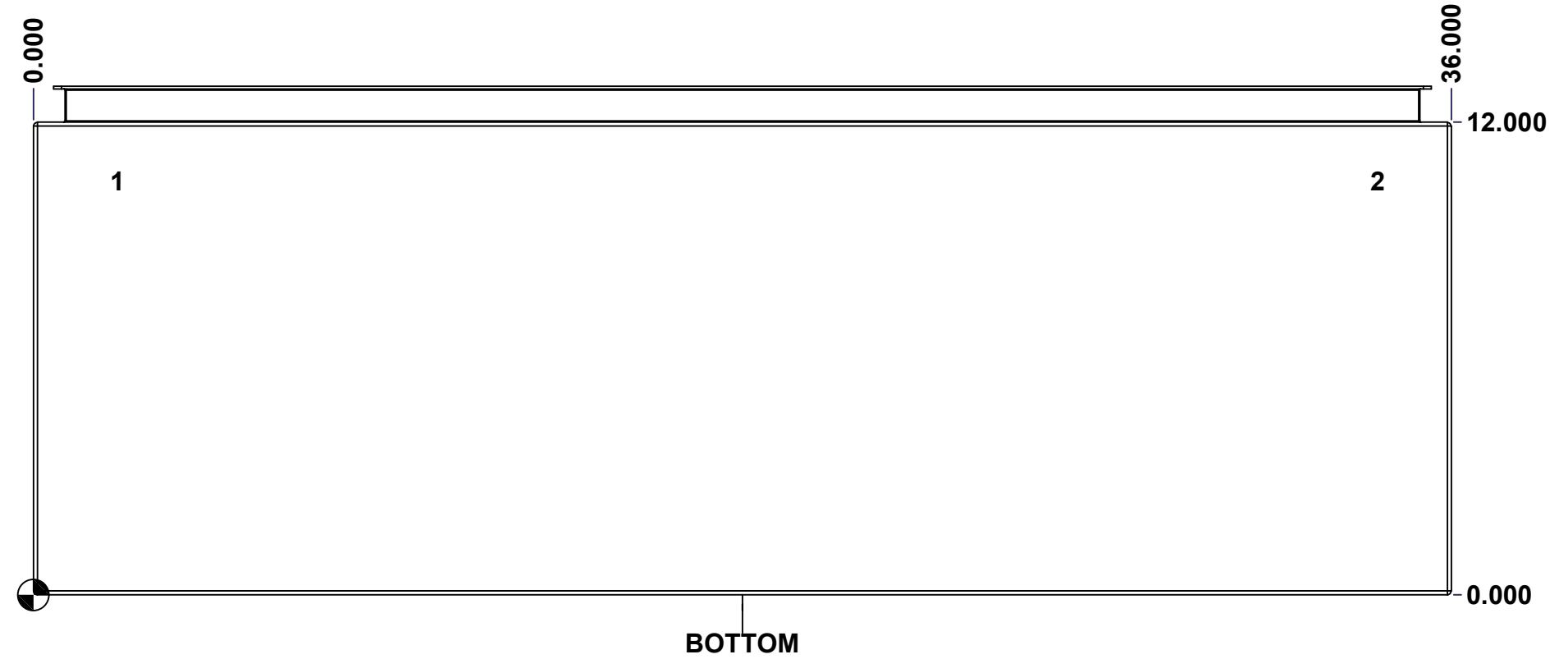

	Description	Status	
	5412ESSP 72" x 36" x 12" Body	(NULL)	
	Part Number Numéro Pièce	Rev.	
	5412ESSP7236126THB	0	5 16

This drawing is confidential and must not be reproduced or used without the consent of EXM

Ce dessin est confidentiel et ne doit pas être reproduit ou utilisé sans le consentement de EXM

STANDARD FEATURES ARE NOT LISTED IN THIS HOLE TABLE

HOLE TABLE - BACK VIEW (CUSTOM FEATURE ONLY)

CUT-OUT	XDIM	YDIM	DESCRIPTION
1	1.875	1.875	IP STUD M8 x 35mm (Inside)
2	1.875	70.125	IP STUD M8 x 35mm (Inside)
3	34.125	70.125	IP STUD M8 x 35mm (Inside)
4	34.125	1.875	IP STUD M8 x 35mm (Inside)
5	1.875	36.000	IP STUD M8 x 35mm (Inside)
6	34.125	36.000	IP STUD M8 x 35mm (Inside)
7	18.000	1.875	IP STUD M8 x 35mm (Inside)
8	18.000	70.125	IP STUD M8 x 35mm (Inside)

9	35.250	0.000	FOOT 885 ESMF4_OPEN
10	0.750	0.000	FOOT 885 ESMF4_OPEN
11	35.250	72.000	FOOT 885 ESMF4_CLOSE
12	0.750	72.000	FOOT 885 ESMF4_CLOSE

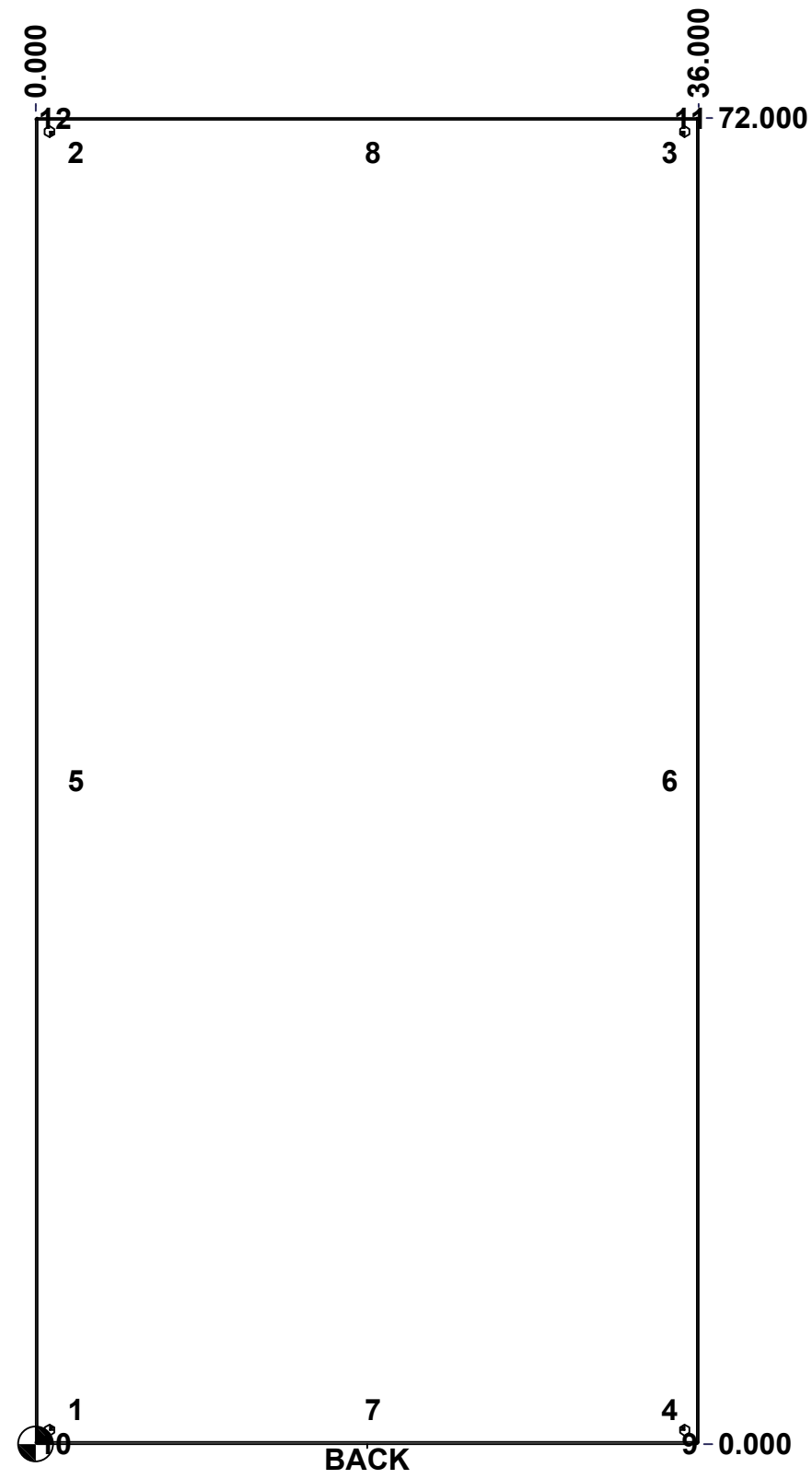

	Description	Status
	5412ESSP 72" x 36" x 12" Body	(NULL)
Part Number Numéro Pièce 5412ESSP7236126THB	Rev.	6
	0	16

This drawing is confidential and must not be reproduced or used without the consent of EXM

Ce dessin est confidentiel et ne doit pas être reproduit ou utilisé sans le consentement de EXM

No.	Revisions	Date	By/Par

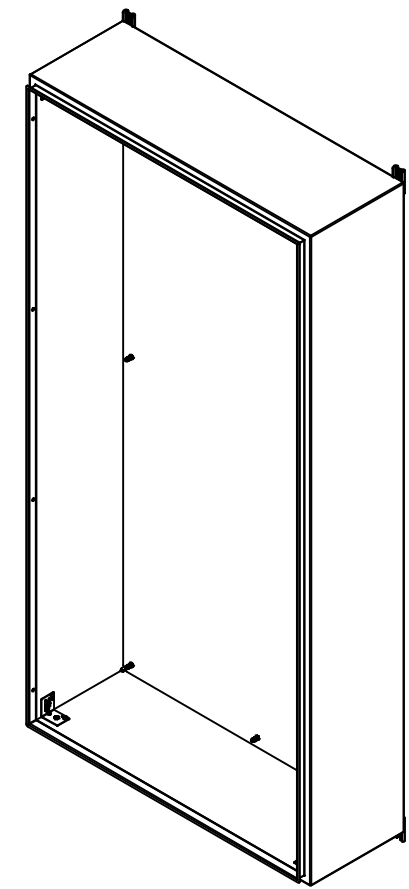

Isometric View



2	885ESMF4-FEET	0	885 ESMF4 Stainless Steel Mounting Foot
4	RIVET_NUT_SS_M10_FH_CE	0	Stainless Steel Rivet Nut M10 (Low Profile Close End)
4	STK-Q-06670	2	M10 x 16mm Stainless Steel Machine Screw
2	885ESMF4-FEET-A	0	885 ESMF4 Stainless Steel Mounting Foot (Opened Slot)
1	STK-K-70554	3	5412 ESTH Accessory Kit
1	5412ESSP7236126TH-RS	0	5412ESSP 72" x 36" Right Insulation
1	5412ESSP7236126TH-LS	0	5412ESSP 72" x 36" Left Insulation
1	5412ESSP7236126TH-BT	0	5412ESSP 72" x 36" Top and Bottom Insulation
1	5412ESSP7236126TH-TP	0	5412ESSP 72" x 36" Top and Bottom Insulation
1	5412ESSP7236126TH-B	0	5412ESSP 72" x 36" Back Insulation
4	STK-Q-16070	1	Stud M6 x 18mm Stainless steel
1	STK-P-02400S	0	Powder Paint (Asa-61 Grey / Smooth)
8	STK-Q-16020	1	Stud M8 x 35mm Stainless Steel
1	5412ESSP7236126THB-P	0	5412ESSP 72" x 36" x 12" Body Part

Qty	Part Number	Rev	Description
Parts List			



Tél: (450) 979-4373
Fax: (450) 979-4626
www.exmweb.com

Flatness
Aplatissement
Max 3.0mm

Projection

Customer Client

Drawn By / Dessiné Par: BoxCad: BoxCad

Material / Matière: 14 Ga Stainless Steel 316 (1.7mm)

Color / Couleur: Asa-61 Grey

Finish / Fini: Smooth

Description: 5412ESSP 72" x 36" x 12" Body

Part Number / Numéro Pièce: **5412ESSP7236126THB**

Date	
Date	13-Apr-23
Detail Rev.	
Rev.	7
	0
	16

This drawing is confidential and must not be reproduced or used without the consent of EXM

Ce dessin est confidentiel et ne doit pas être reproduit ou utilisé sans le consentement de EXM

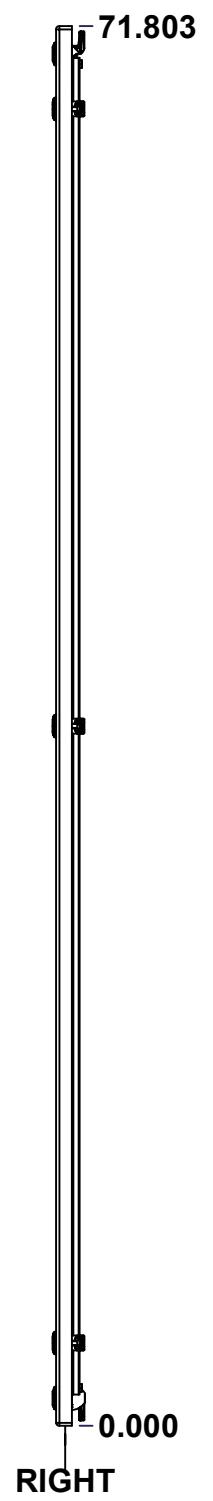
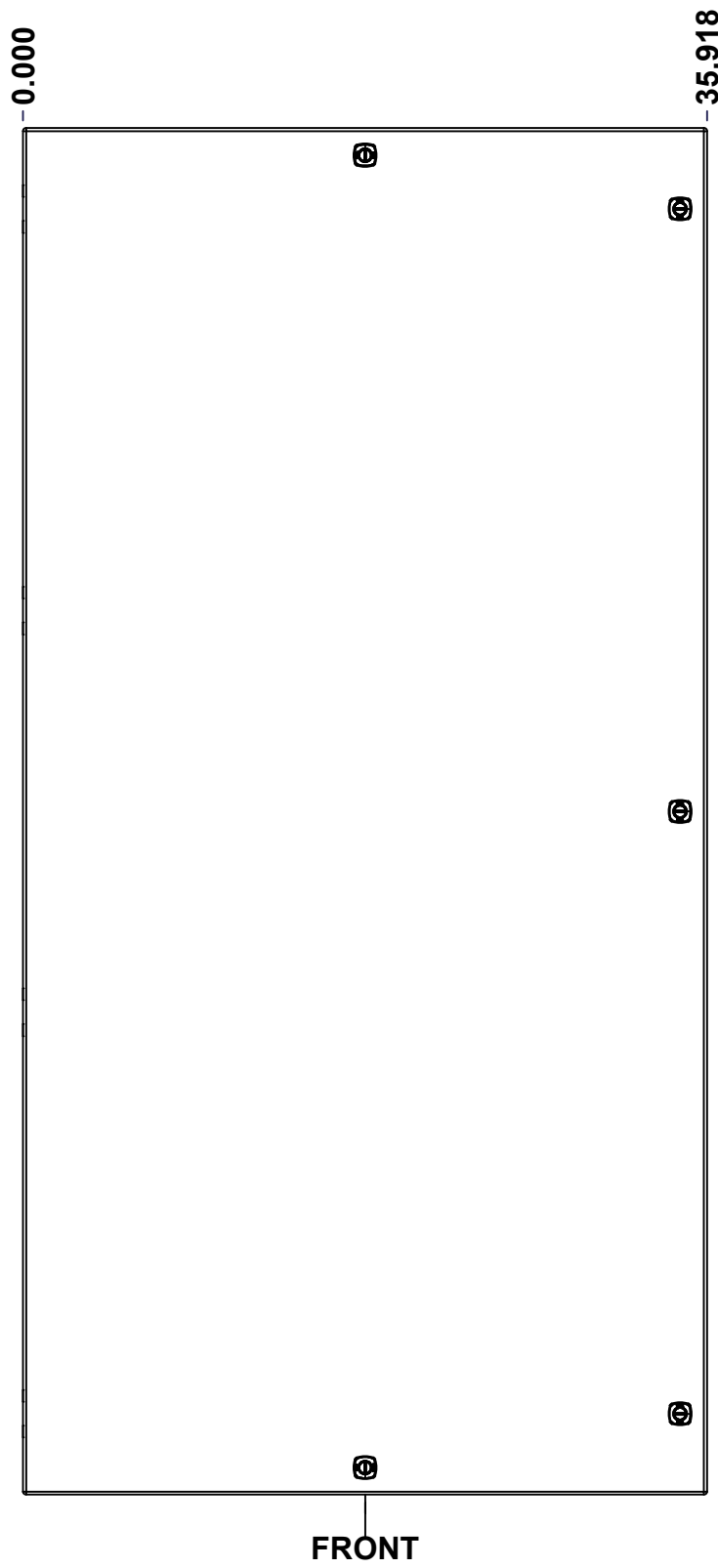
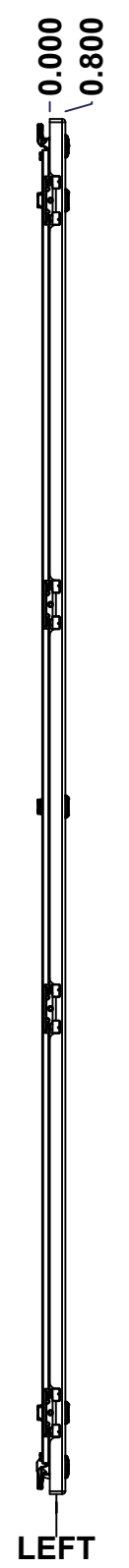
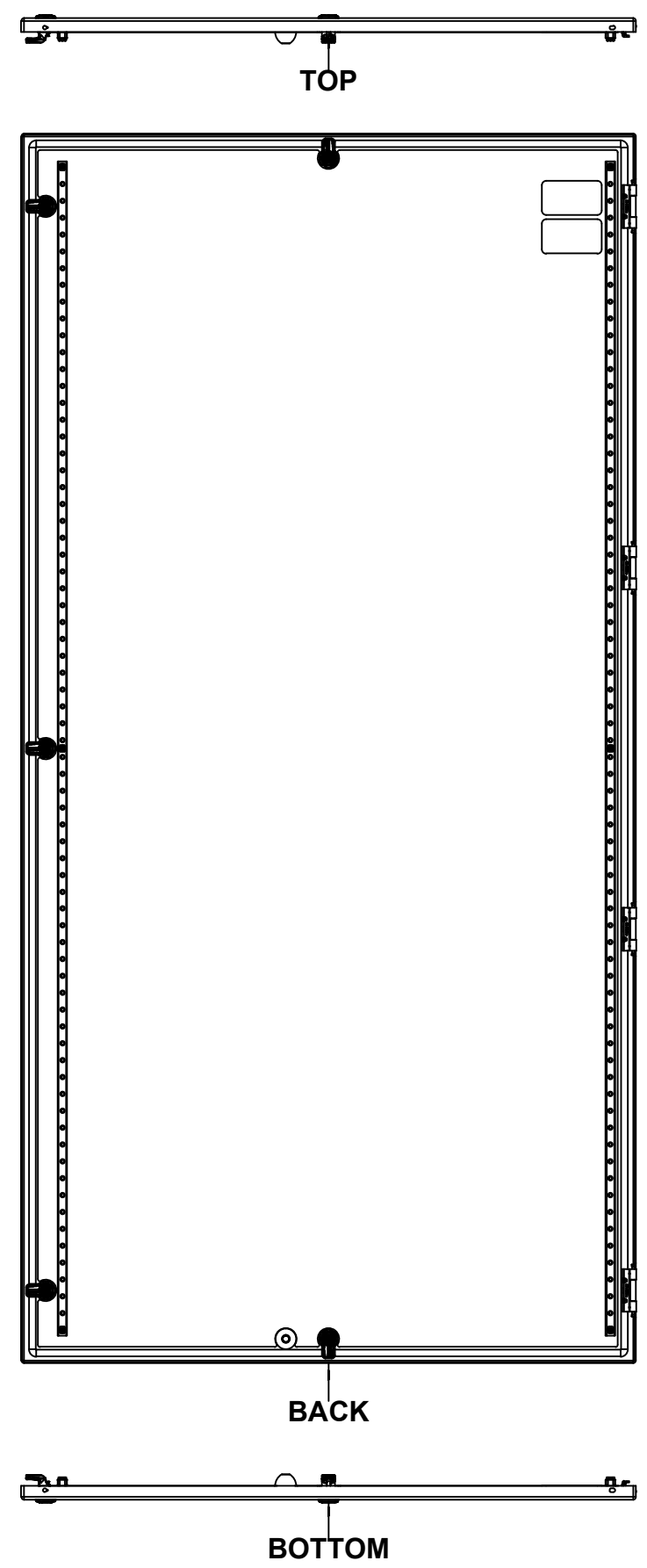

No.	Revisions	Date	By/Par

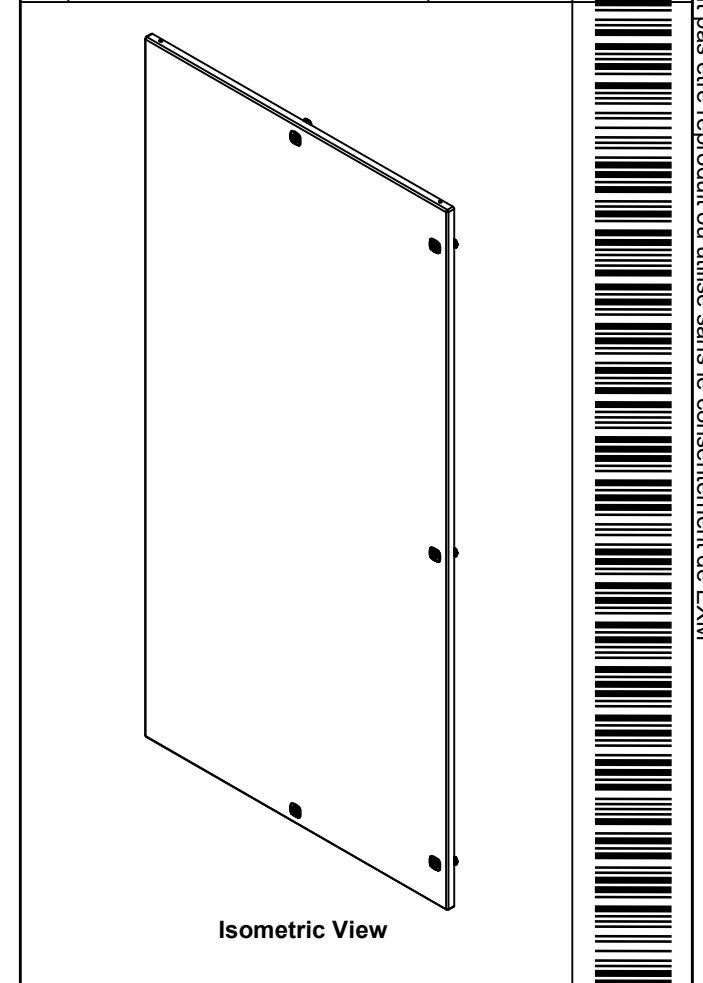

 Tél: (450) 979-4373 Fax: (450) 979-4626 www.exmweb.com		Flatness Aplatissement Max 3.0mm Projection 
Customer Client	Date	
Drawn By Dessiné Par	BoxCad: BoxCad	Date 13-Apr-23
Material Matière	14 Ga Stainless Steel 316 (1.7mm)	
Color Couleur	Asa-61 Grey	Finish Fini Smooth
Description 5412ESSP 72" x 36" Cover		Detail Rev.
Part Number Numéro Pièce	Rev. 0	8 / 16

SEE BILL OF MATERIAL ON LAST PAGE **5412ESSP7236126THC**

This drawing is confidential and must not be reproduced or used without the consent of EXM

Ce dessin est confidentiel et ne doit pas être reproduit ou utilisé sans le consentement de EXM

STANDARD FEATURES ARE NOT LISTED IN THIS HOLE TABLE

HOLE TABLE - FRONT VIEW (CUSTOM FEATURE ONLY)

CUT-OUT	XDIM	YDIM	DESCRIPTION
1	1.486	1.945	STUD M6 x 18mm (Inside)
2	1.486	69.858	STUD M6 x 18mm (Inside)
3	33.517	69.858	STUD M6 x 18mm (Inside)
4	33.517	1.945	STUD M6 x 18mm (Inside)
5	1.486	35.902	STUD M6 x 18mm (Inside)
6	33.517	35.902	STUD M6 x 18mm (Inside)
7	20.459	1.435	STUD M6 x 18mm (Inside)

8	34.494	67.553	880 SCQ4-SLSS6
9	34.494	35.902	880 SCQ4-SLSS6
10	34.494	4.250	880 SCQ4-SLSS6
11	17.959	70.379	880 SCQ4-SLSS6
12	17.959	1.424	880 SCQ4-SLSS6

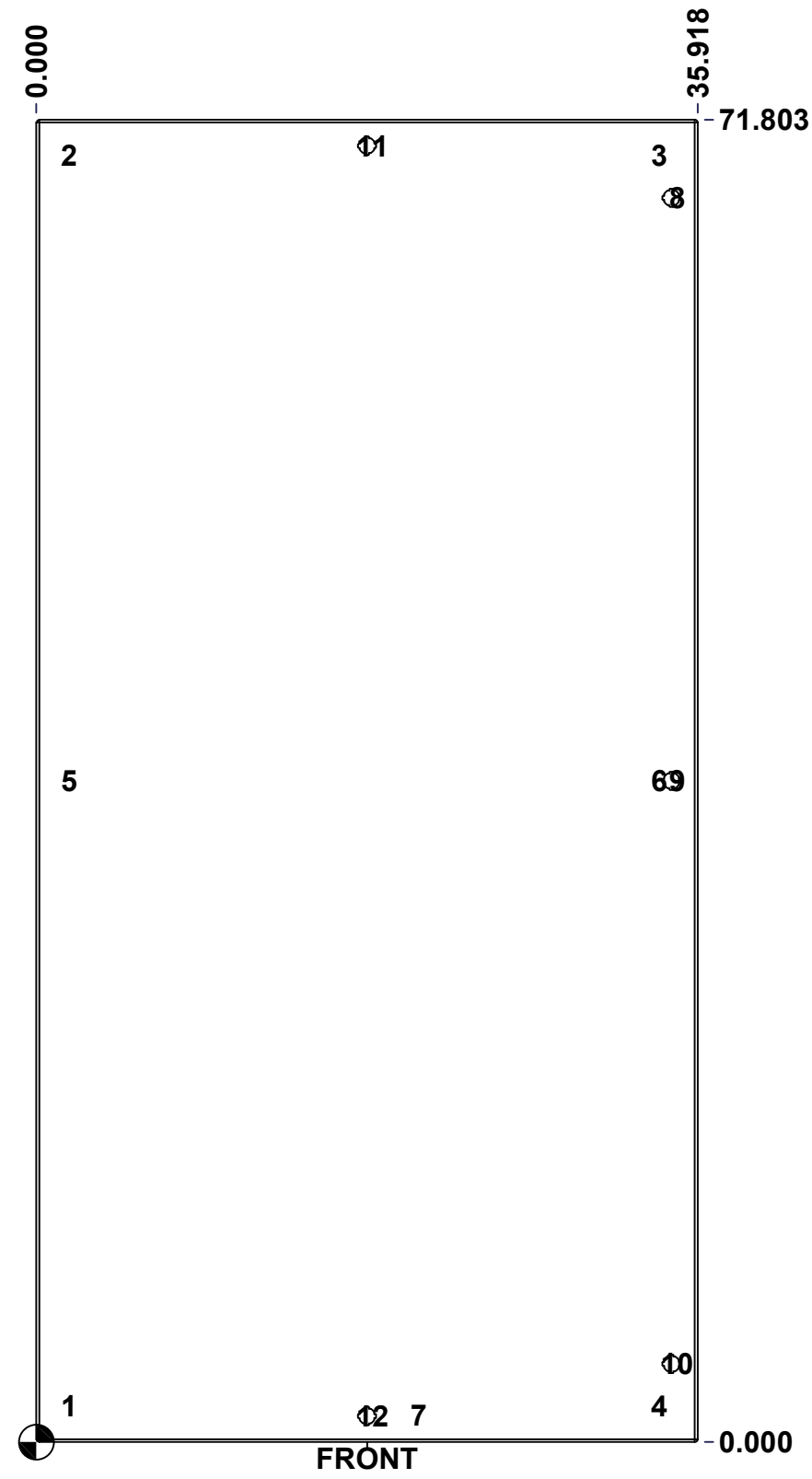

	Description	Status
	5412ESSP 72" x 36" Cover	(NULL)
	Part Number Numéro Pièce	Rev.
	5412ESSP7236126THC	0 / 9
		16

This drawing is confidential and must not be reproduced or used without the consent of EXM

Ce dessin est confidentiel et ne doit pas être reproduit ou utilisé sans le consentement de EXM

No.	Revisions	Date	By/Par

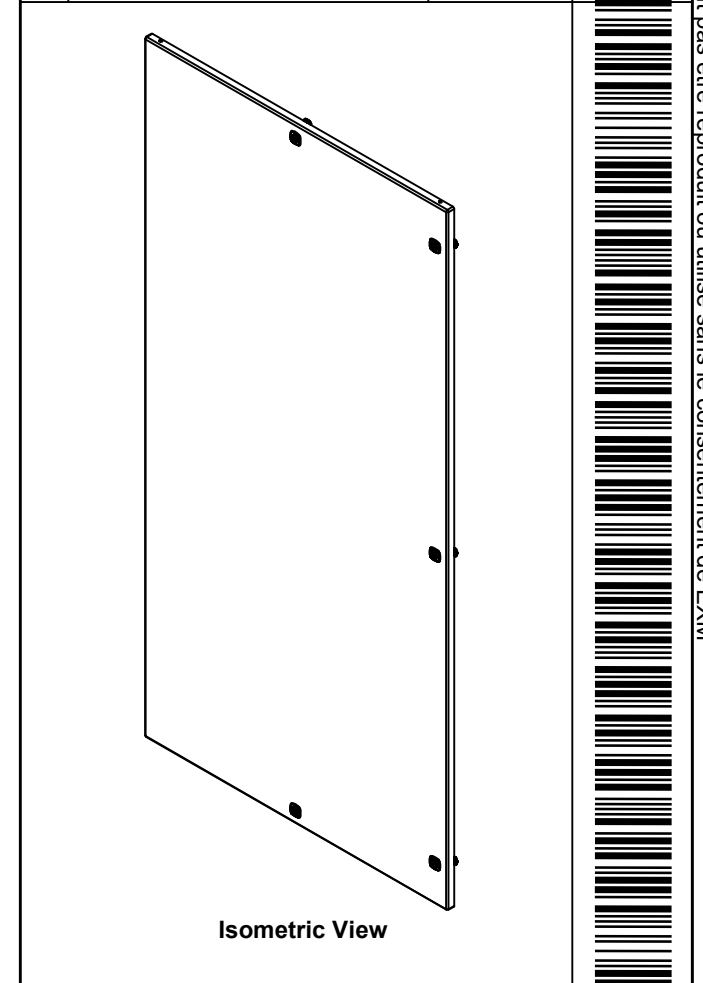

EXM
www.exmweb.com

Tél: (450) 979-4373
Fax: (450) 979-4626

Flatness
Aplatissement
Max 3.0mm

Projection

2	STK-S-00100	0	3.5" x 2" Silver Milar Flexcon Sticker
6	STK-Q-07250	2	M6 x 16mm Collar Nut
2	STK-Q-46020-72	5	5412 ES Vertical Door Stiffener 72"
1	5412ESSP7236126THI-C	0	5412ESSP 72" x 36" Cover Insulation
1	STK-P-02400S	0	Powder Paint (Asa-61 Grey / Smooth)
1	STK-Q-46515	3	5412 ES Door Support with Brass Insert
7	STK-Q-16070	1	Stud M6 x 18mm Stainless steel
1	5412ESSP7236126THG	0	5412ESSP 72" x 36" Cover Gasket Part
1	5412ESSP7236126THC-P	0	5412ESSP 72" x 36" Cover Part
5	880 SCQ4-SLSS6	7	5412 ESS 1/4 Turn Lock
4	STK-A-33016	0	5412 ESS Bended Hinge (Body Part)
QTY	Part Number	Rev	Description
Parts List			

Customer Client	Date
Drawn By Dessiné Par	Date 13-Apr-23
Material Matière	14 Ga Stainless Steel 316 (1.7mm)
Color Couleur	Asa-61 Grey
Finish Fini	Smooth
Description	Detail Rev.
5412ESSP 72" x 36" Cover	
Part Number Numéro Pièce	Rev. 10
5412ESSP7236126THC	0 16

This drawing is confidential and must not be reproduced or used without the consent of EXM

Ce dessin est confidentiel et ne doit pas être reproduit ou utilisé sans le consentement de EXM

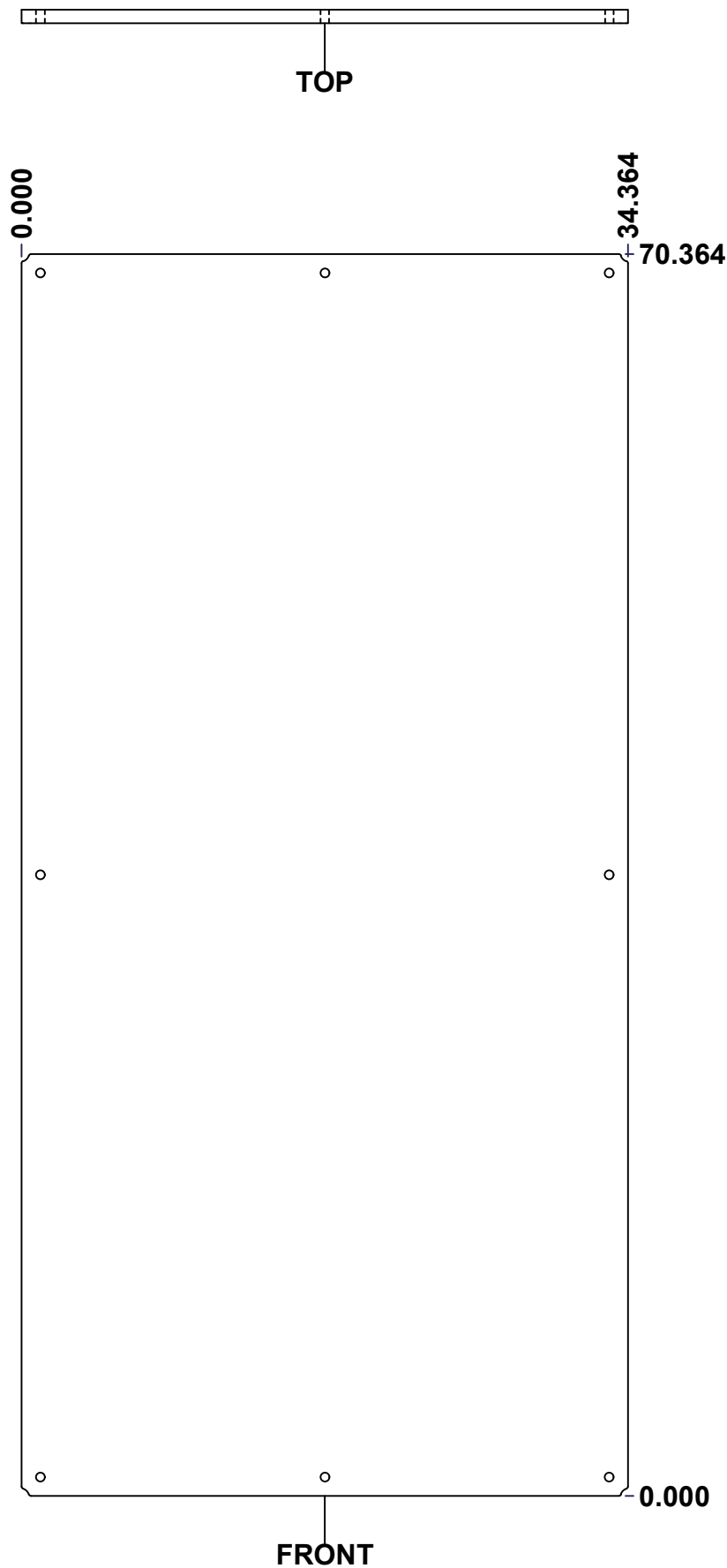

No.	Revisions	Date	By/Par

Isometric View

<p>Tél: (450) 979-4373 Fax: (450) 979-4626 www.exmweb.com</p>		Flatness Aplatissement Max 3.0mm Projection
Customer Client	Date	
Drawn By / Dessiné Par: BoxCad: Patrick Deschenes	Date: 23-Jan-07	
Material / Matière: Polyisocyanurate		
Color / Couleur: Aluminum	Finish / Fini: N/A	
Description: 5412ESSP 72" x 36" Back Insulation		Detail Rev.:
Part Number / Numéro Pièce: 5412ESSP7236126THI-B	Rev.:	11 / 16

SEE BILL OF MATERIAL ON LAST PAGE

This drawing is confidential and must not be reproduced or used without the consent of EXM

Ce dessin est confidentiel et ne doit pas être reproduit ou utilisé sans le consentement de EXM

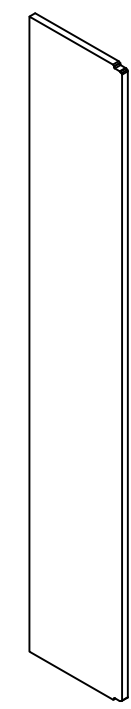
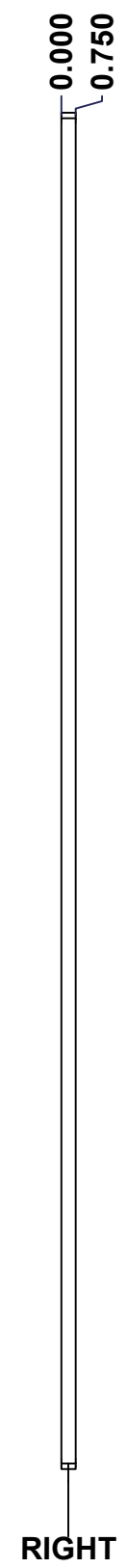
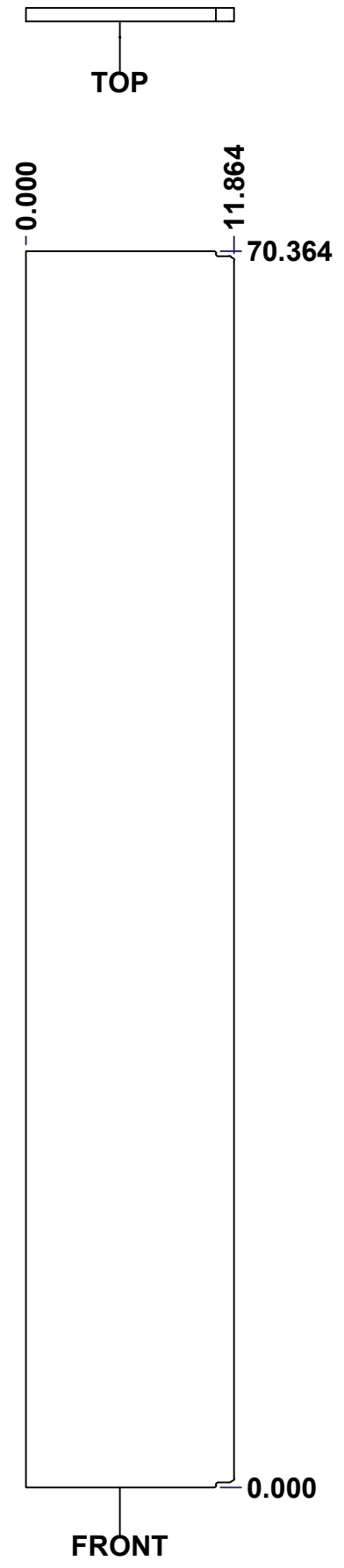

Isometric View

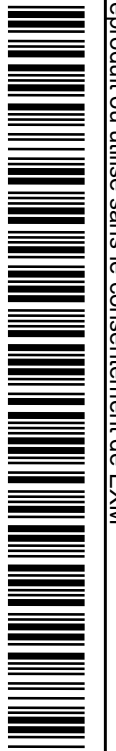

No.	Revisions	Date	By/Par

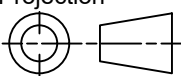
 Tél: (450) 979-4373 Fax: (450) 979-4626 www.exmweb.com		Flatness Aplatissement Max 3.0mm
Projection 		Date 23-Jan-07
Customer Client	Date	
Drawn By Dessiné Par	BoxCad: Patrick Deschenes	Date 23-Jan-07
Material Matière	Polyisocyanurate	
Color Couleur	Aluminum	Finish Fini N/A
Description	Detail Rev.	
5412ESSP 72" x 36" Left Insulation		
Part Number Numéro Pièce	Rev. 0	12 / 16
5412ESSP7236126TH-LS		

SEE BILL OF MATERIAL ON LAST PAGE

This drawing is confidential and must not be reproduced or used without the consent of EXM

Ce dessin est confidentiel et ne doit pas être reproduit ou utilisé sans le consentement de EXM

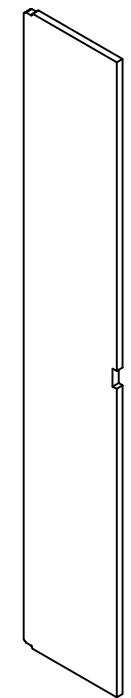
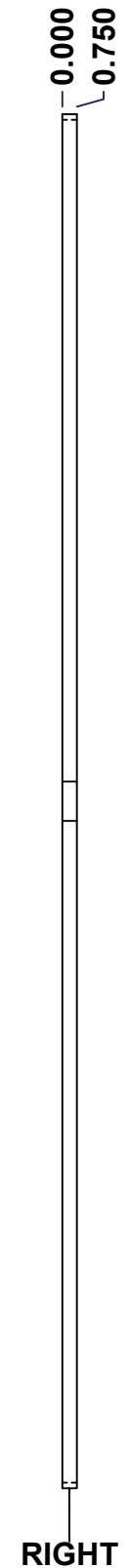
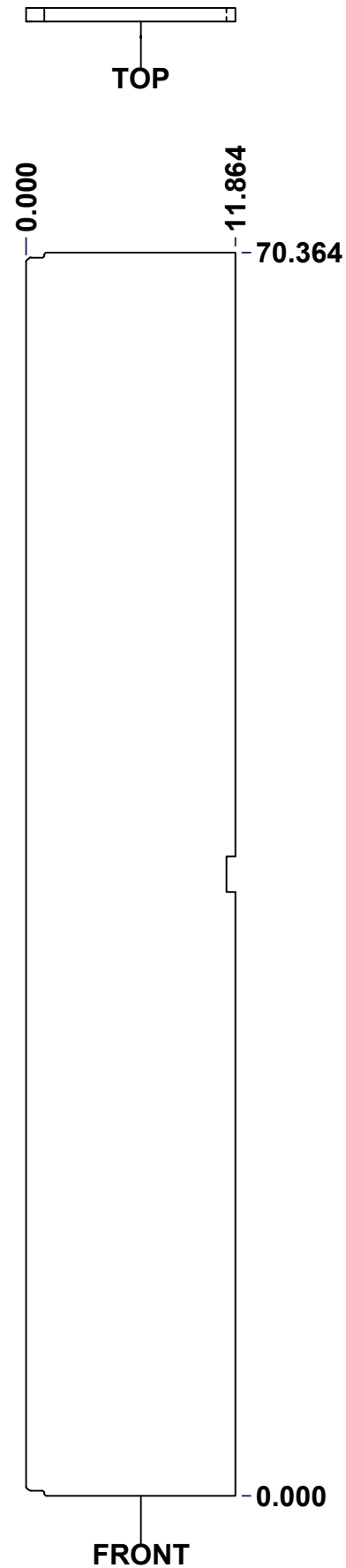

Isometric View

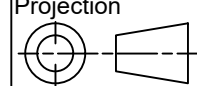

No.	Revisions	Date	By/Par

 Tél: (450) 979-4373 Fax: (450) 979-4626 www.exmweb.com		Flatness Aplatissement Max 3.0mm
Projection 		Date 23-Jan-07
Customer Client	Date	
Drawn By / Dessiné Par: BoxCad: Patrick Deschenes	Date: 23-Jan-07	
Material / Matière: Polyisocyanurate		
Color / Couleur: Aluminum	Finish / Fini: N/A	
Description: 5412ESSP 72" x 36" Right Insulation	Detail Rev.	
Part Number / Numéro Pièce: 5412ESSP7236126THI-RS	Rev. 0	13 / 16

SEE BILL OF MATERIAL ON LAST PAGE

This drawing is confidential and must not be reproduced or used without the consent of EXM

Ce dessin est confidentiel et ne doit pas être reproduit ou utilisé sans le consentement de EXM

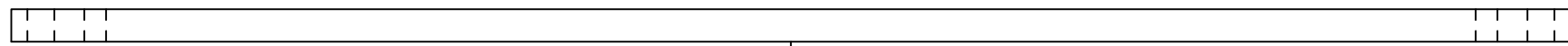

TOP

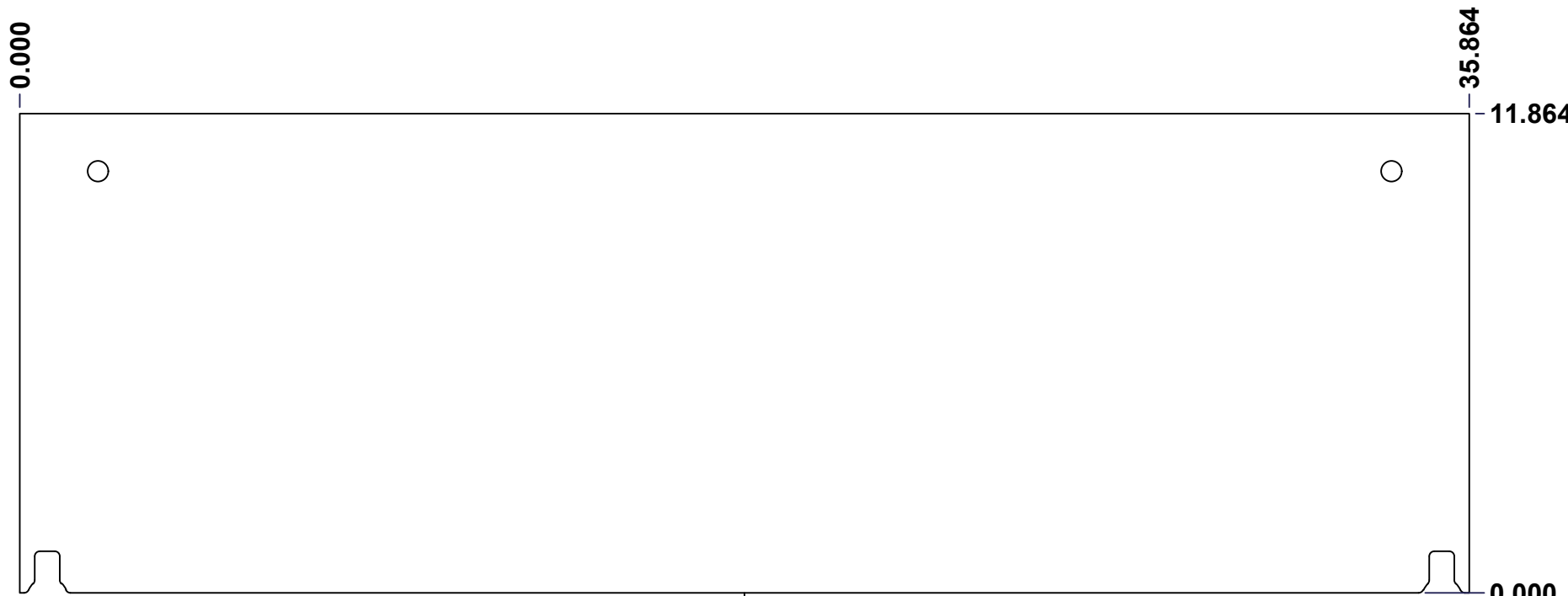

FRONT

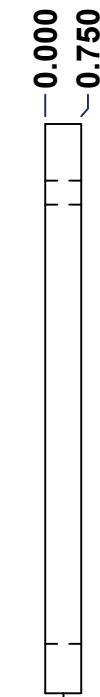

RIGHT

No.	Revisions	Date	By/Par

Isometric View

Tél: (450) 979-4373 Fax: (450) 979-4626 www.exmweb.com		Flatness Aplatissement	
		Max 3.0mm	
Customer Client		Date	
Drawn By Dessiné Par		Date	
Material Matière		Polyisocyanurate	
Color Couleur		Finish Fini	
Aluminum		N/A	
Description 5412ESSP 72" x 36" Top and Bottom Insulation			Detail Rev.
Part Number Numéro Pièce		Rev.	14
SEE BILL OF MATERIAL ON LAST PAGE		0	16

SEE BILL OF MATERIAL ON LAST PAGE

5412ESSP7236126THI-TP

This drawing is confidential and must not be reproduced or used without the consent of EXM

Ce dessin est confidentiel et ne doit pas être reproduit ou utilisé sans le consentement de EXM

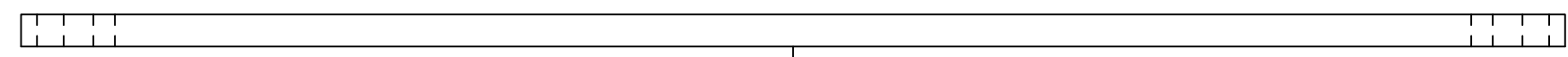

TOP

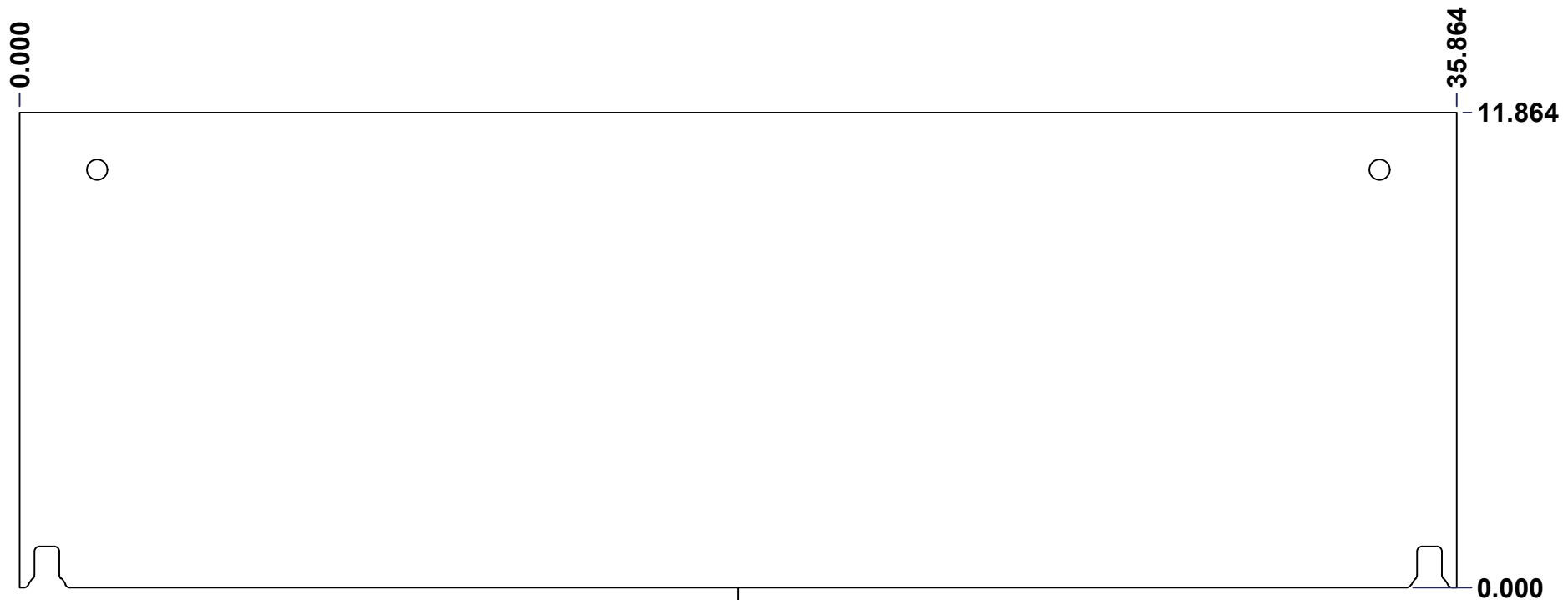

FRONT

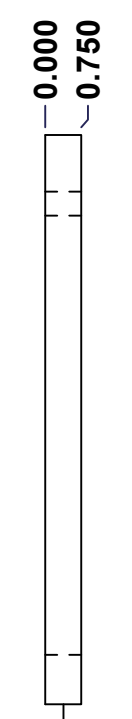

RIGHT

No.	Revisions	Date	By/Par

Isometric View

Tél: (450) 979-4373 Fax: (450) 979-4626 www.exmweb.com		Flatness Aplatissement	
		Max 3.0mm	
Customer Client		Date	
Drawn By Dessiné Par		Date	
Material Matière		Polyisocyanurate	
Color Couleur		Finish Fini	
Aluminum		N/A	
Description 5412ESSP 72" x 36" Top and Bottom Insulation			Detail Rev.
Part Number Numéro Pièce		Rev.	15
5412ESSP7236126THI-BT		0	16

SEE BILL OF MATERIAL ON LAST PAGE

This drawing is confidential and must not be reproduced or used without the consent of EXM

Ce dessin est confidentiel et ne doit pas être reproduit ou utilisé sans le consentement de EXM

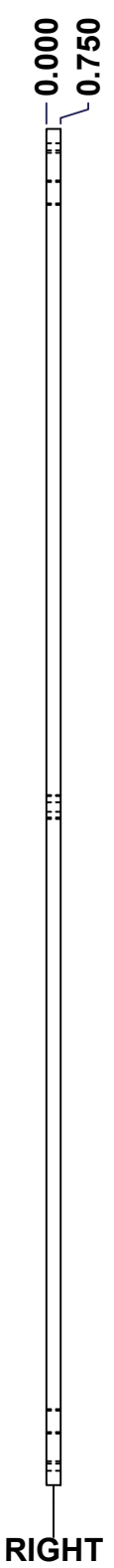
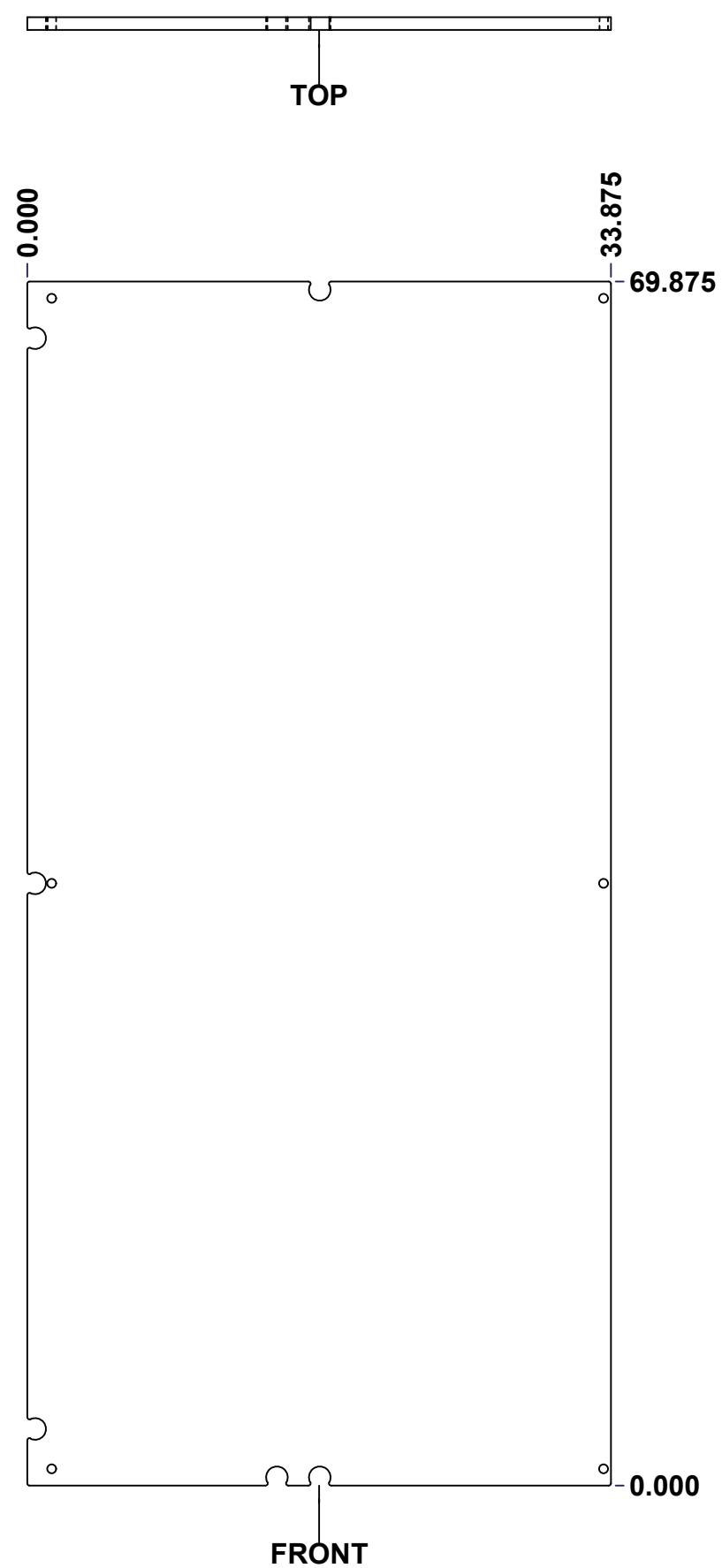

No.	Revisions	Date	By/Par

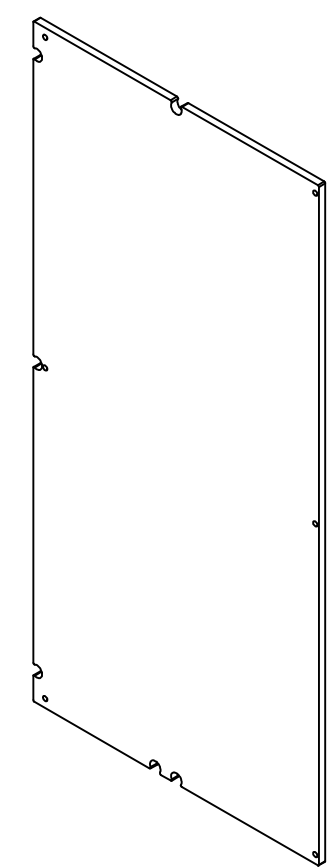

Isometric View

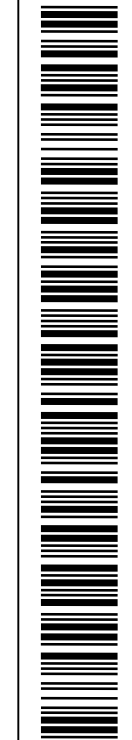

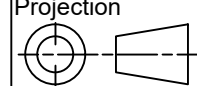
 Tél: (450) 979-4373 Fax: (450) 979-4626 www.exmweb.com		Flatness Aplatissement Max 3.0mm
Customer Client		Projection 
Drawn By / Dessiné Par: BoxCad: Patrick Deschenes		Date: 23-Jan-07
Material / Matière: Polyisocyanurate		
Color / Couleur: Aluminum	Finish / Fini: N/A	
Description: 5412ESSP 72" x 36" Cover Insulation		Detail Rev.
Part Number / Numéro Pièce: 5412ESSP7236126TH-C		Rev. 0 / 16

SEE BILL OF MATERIAL ON LAST PAGE

This drawing is confidential and must not be reproduced or used without the consent of EXM

Ce dessin est confidentiel et ne doit pas être reproduit ou utilisé sans le consentement de EXM

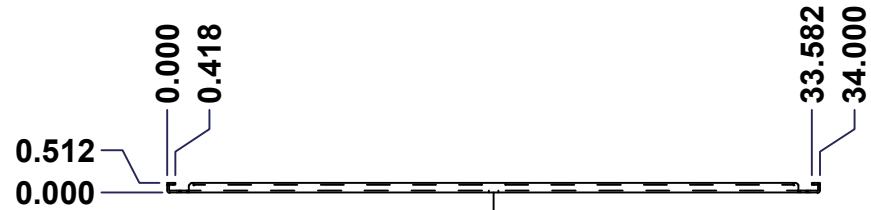

TOP

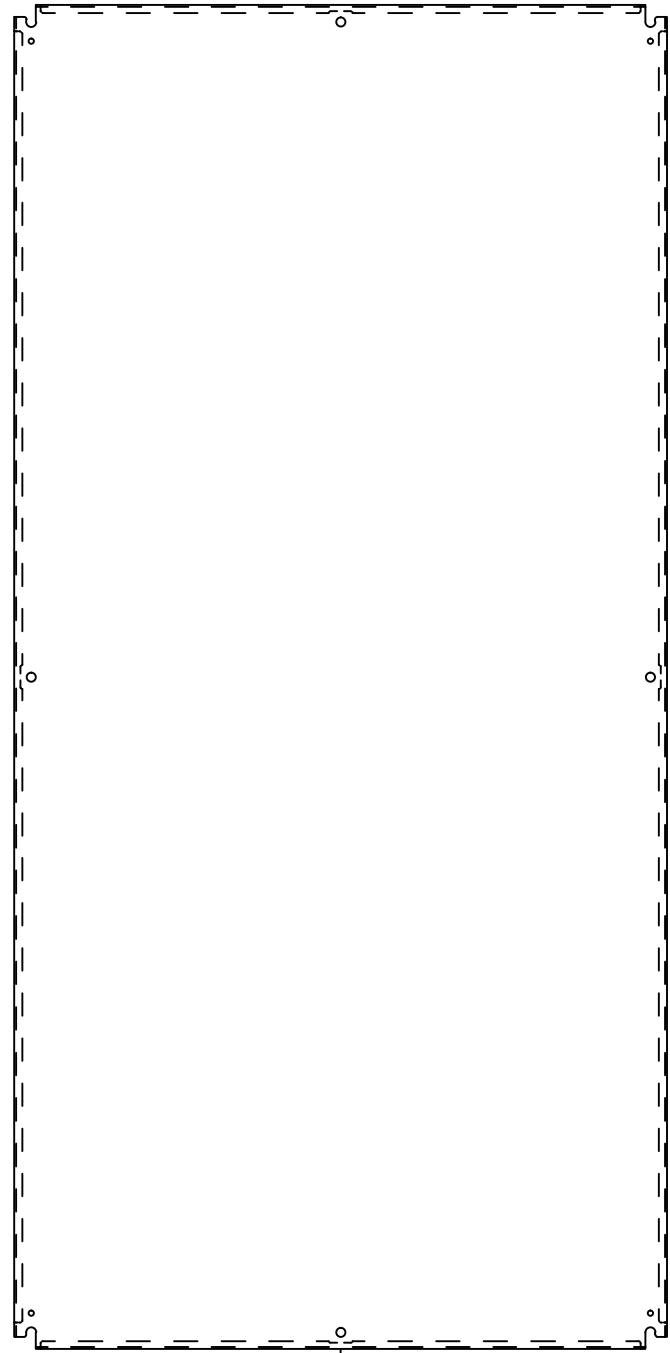

FRONT

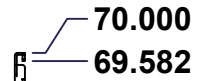

RIGHT

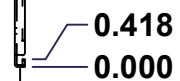

No.	Revisions	Date	By/Par

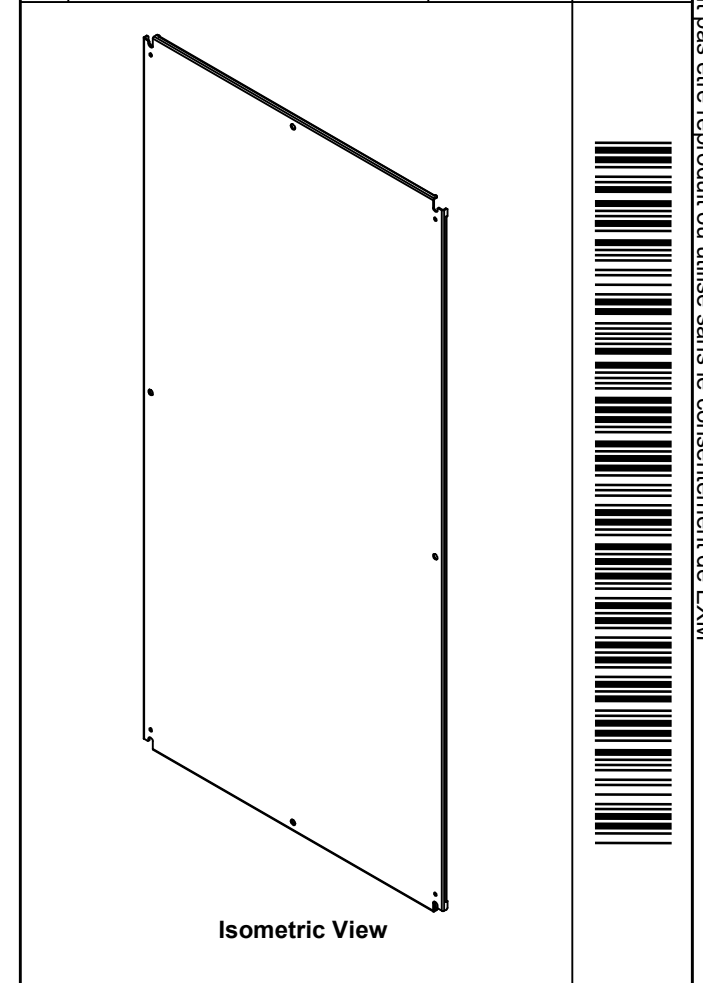

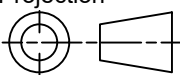
 Tél: (450) 979-4373 Fax: (450) 979-4626 www.exmweb.com		Flatness Aplatissement Max 3.0mm Projection 
Customer Client	Date	
Drawn By Dessiné Par: BoxCad	Date: 23-Jan-07	
Material Matière	See Part List	
Color Couleur	See Part List	Finish Fini: See Part List
Description: 881 SP - Inner Panel		Detail Rev.
Part Number Numéro Pièce: 881 SP7236G		Rev. 1/2

Qty	Part Number	Rev	Description	Material	Color	Finish
1	881 SP7236G-P	0	881 SP - Inner Panel Part	12 Ga Galvanized	Unpainted	Galvanized

Parts List

This drawing is confidential and must not be reproduced or used without the consent of EXM

Ce dessin est confidentiel et ne doit pas être reproduit ou utilisé sans le consentement de EXM

Table 1			FRONT VIEW
CUT-OUT	XDIM	YDIM	DESCRIPTION
1	17.000	0.875	MTG STUD HOLE (RND Ø0.500)
2	0.875	35.000	MTG STUD HOLE (RND Ø0.500)
3	33.125	35.000	MTG STUD HOLE (RND Ø0.500)
4	17.000	69.125	MTG STUD HOLE (RND Ø0.500)
5	0.875	1.875	GROUND HOLE (RND Ø0.290)
6	33.125	1.875	GROUND HOLE (RND Ø0.290)
7	0.875	68.125	GROUND HOLE (RND Ø0.290)
8	33.125	68.125	GROUND HOLE (RND Ø0.290)

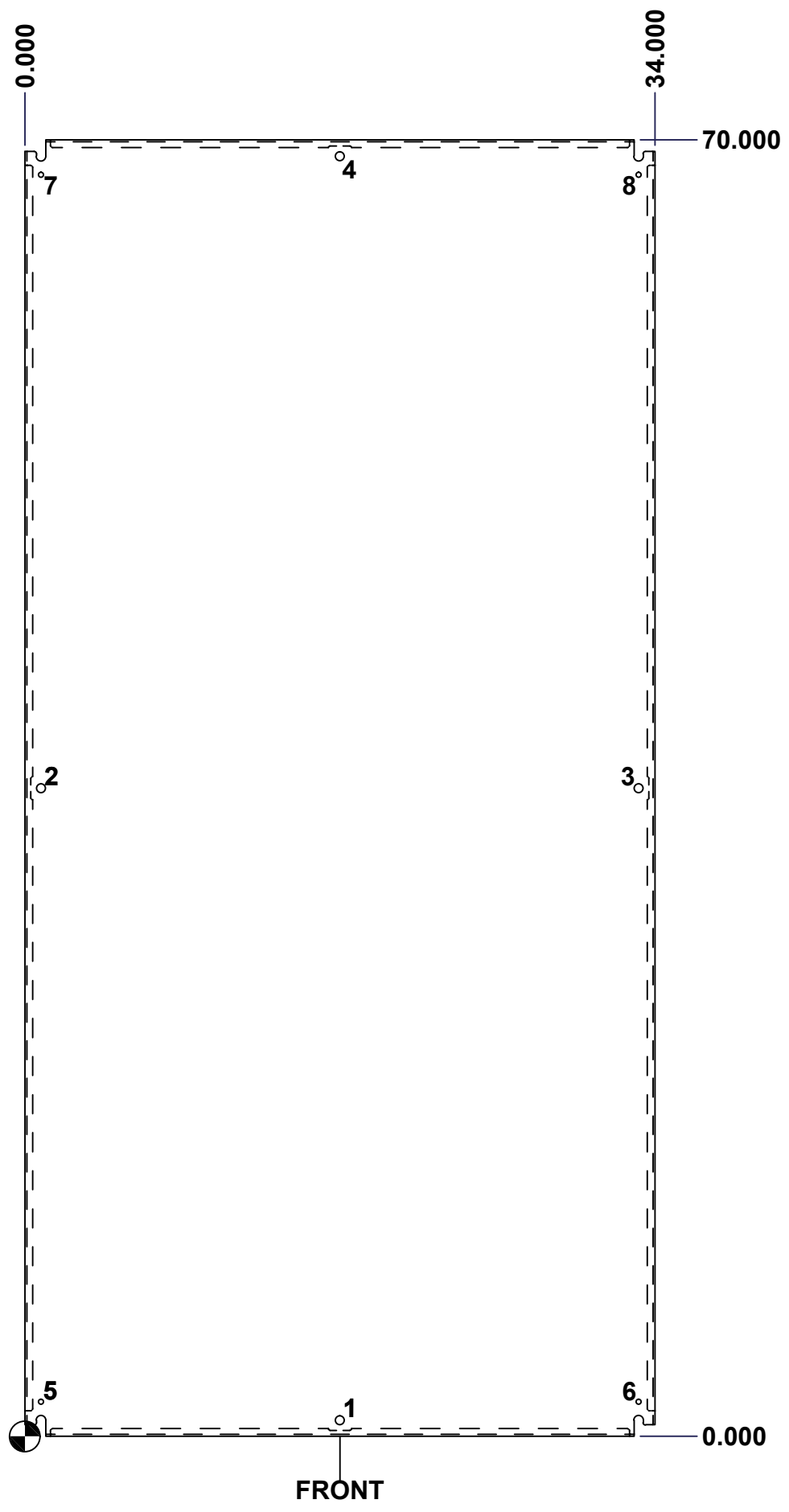

All knockouts are actual size / Les disques défonçables sont grandeur réel

No.	Revisions	Date	By/Par

Isometric View

		Tél: (450) 979-4373 Fax: (450) 979-4626 www.exmweb.com		Flatness Aplatissement Max 3.0mm	
Customer Client		Date		Projection 	
Drawn By Dessiné Par BoxCad		Date 23-Jan-07		Material Matière See Part List	
Color Couleur See Part List		Finish Fini See Part List		Description 881 SP - Inner Panel	
Part Number Numéro Pièce 881 SP7236G		Rev. 0		Detail Rev. 2	