

This drawing is confidential and must not be reproduced or used without the consent of EXM

Ce dessin est confidentiel et ne doit pas être reproduit ou utilisé sans le consentement de EXM

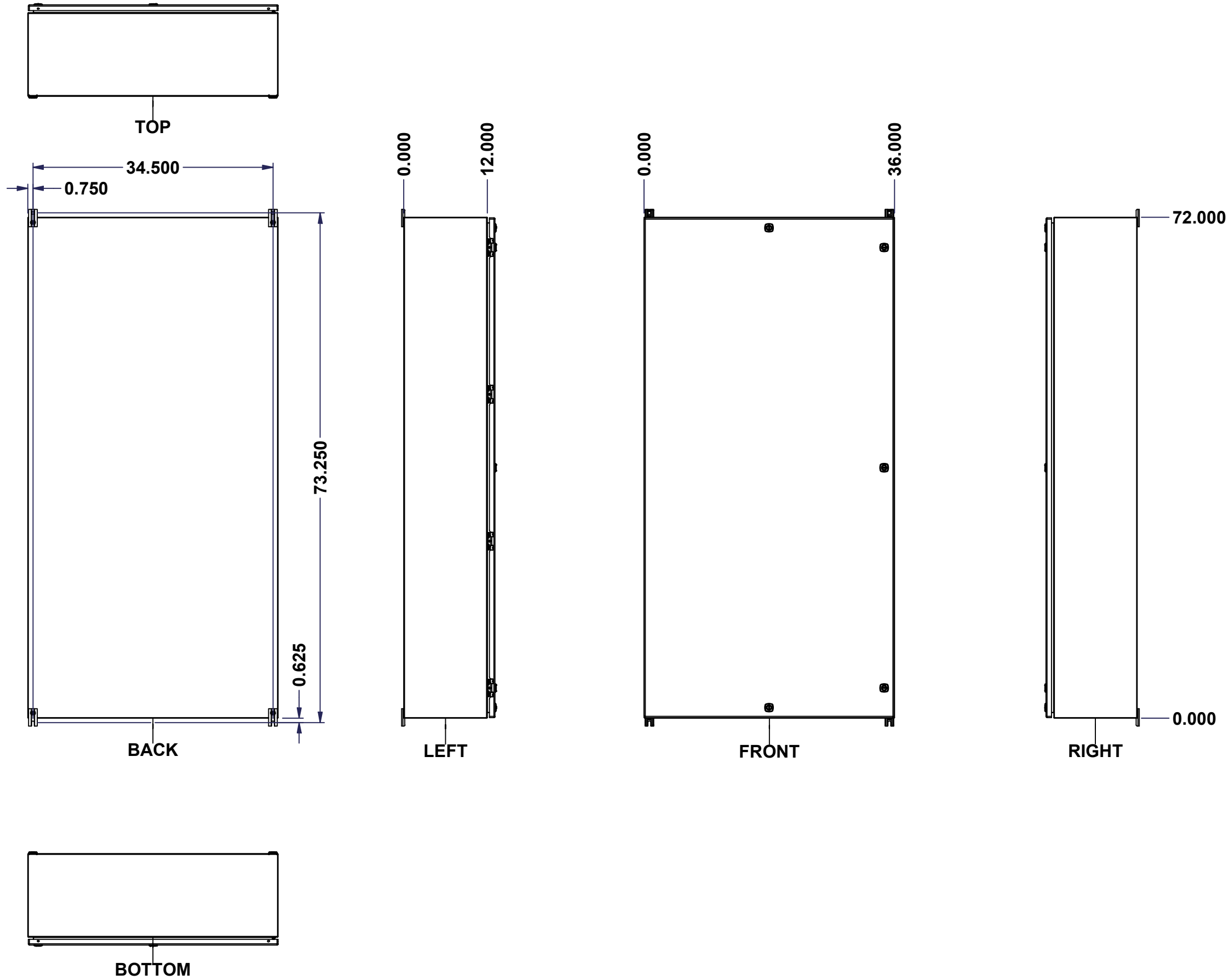

No.	Revisions	Date	By/Par

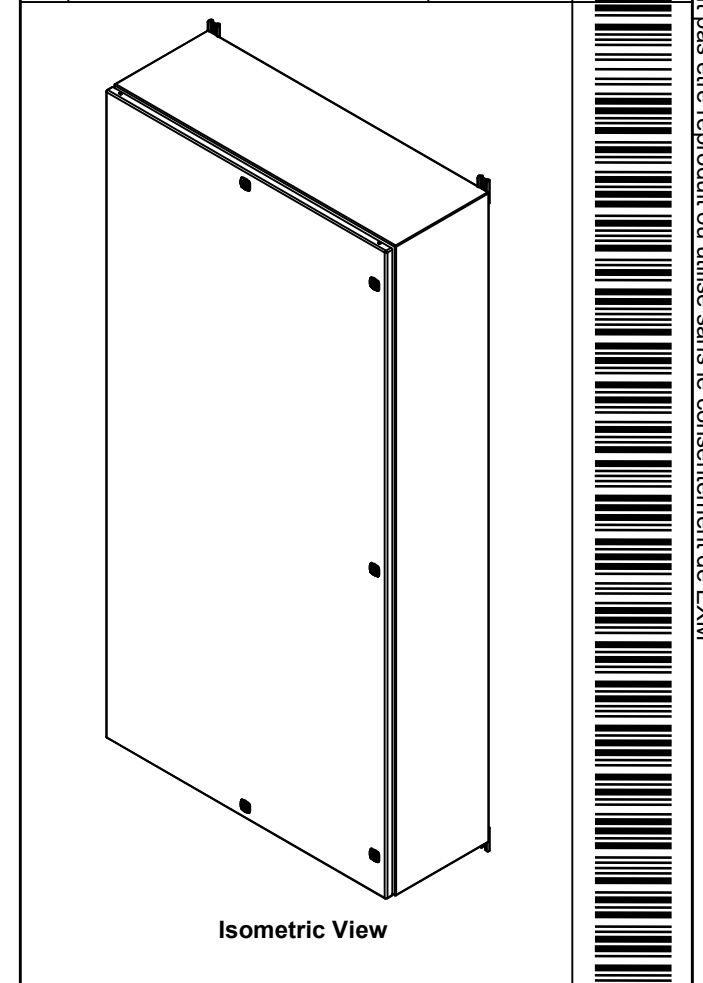

		Flatness / Aplatissement Max 3.0mm Projection 	
Customer / Client Date		Date 02-May-23	
Drawn By / Dessiné Par: BoxCad: BoxCad		Material / Matière: 14 Ga Stainless Steel 316 (1.7mm)	
Color / Couleur: Asa-61 Grey		Finish / Fini: Smooth	
Description: 5412ESSP 72" x 36" x 12" Assembly			Detail Rev.
Part Number / Numéro Pièce: 5412ESSP7236126THNOIP		Rev. 0	1 / 16

SEE BILL OF MATERIAL ON LAST PAGE 5412ESSP7236126THNOIP

This drawing is confidential and must not be reproduced or used without the consent of EXM

Ce dessin est confidentiel et ne doit pas être reproduit ou utilisé sans le consentement de EXM

NOTE	
ITEM	DESCRIPTION
1	NEMA 4X Enclosure
2	C/W Standard ground studs on box and cover
3	C/W Standard door stiffener
4	W/O Inner panel
5	C/W Standard inner panel mounting studs
6	C/W Special locks sold separately (Installed)
7	C/W 885 ESMF4_OPEN Sold separately (Installed)
8	C/W 885 ESMF4_CLOSE Sold separately (Installed)
9	C/W R5 Insulation (Installed by EXM)

No.	Revisions	Date	By/Par

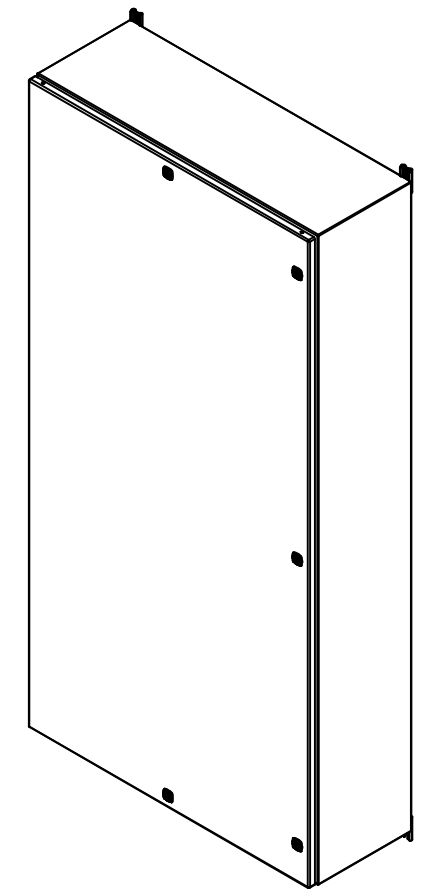

Isometric View



 Tél: (450) 979-4373  
 Fax: (450) 979-4626  
[www.exmweb.com](http://www.exmweb.com)

Flatness / Aplatissement: Max 3.0mm  
 Projection: 

Customer Client	Date
Drawn By / Dessiné Par: BoxCad: BoxCad	Date: 02-May-23

Material / Matière: 14 Ga Stainless Steel 316 (1.7mm)

Color / Couleur: Asa-61 Grey	Finish / Fini: Smooth
------------------------------	-----------------------

Description: 5412ESSP 72" x 36" x 12" Assembly

Part Number / Numéro Pièce: <b>5412ESSP7236126THNOIP</b>	Rev. / Révis: <b>0</b>	2	16
--	------------------------	---	----

PACKING		
ITEM	QTY	DESCRIPTION
Cardboard sleeve	2	Top and Bottom
Cardboard strip	2	Between back of enclosure and inner panel
Plastic bag	1	To protect cover surface and inside gasket
Cardboard corner	4	To reinforced for the plastic strap tightening
Plastic strap - Black	2	To Squeeze the 2 cardboard sleeve together
Packaging label	3	White label with PN
Plastic strap- Green	2	To secure the enclosure to the wood pallet
Wood Pallet	1	2" deeper and 3" larger than enclosure size

Qty	Part Number	Rev	Description
8	STK-Q-00600	2	M12 to M8 Adaptor
1	STK-K-01800	5	5412 ES Accessory Kit
1	5412ESSP7236126THNOI PC	0	5412ESSP 72" x 36" Cover
1	5412ESSP7236126THNOI PB	0	5412ESSP 72" x 36" x 12" Body
4	STK-Q-04051-08	1	M6 x 8mm Stainless Steel Hexagon Socket Head Machine Screw with Nyseal
Parts List			

This drawing is confidential and must not be reproduced or used without the consent of EXM

Ce dessin est confidentiel et ne doit pas être reproduit ou utilisé sans le consentement de EXM

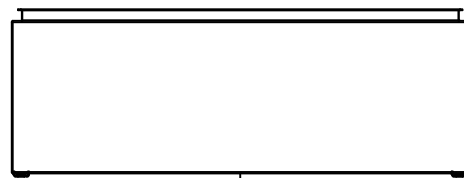

TOP

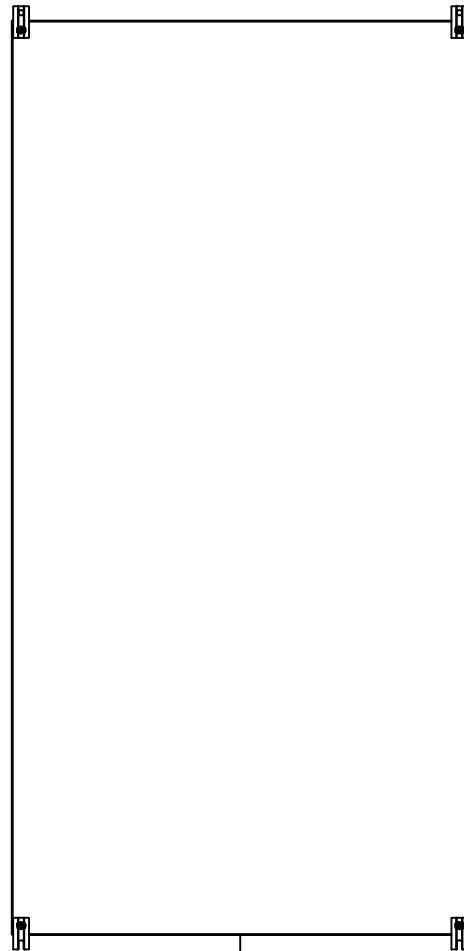

BACK

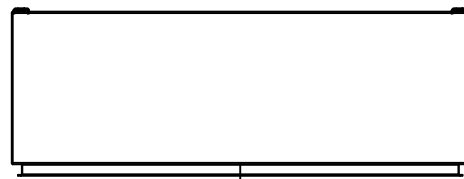

BOTTOM

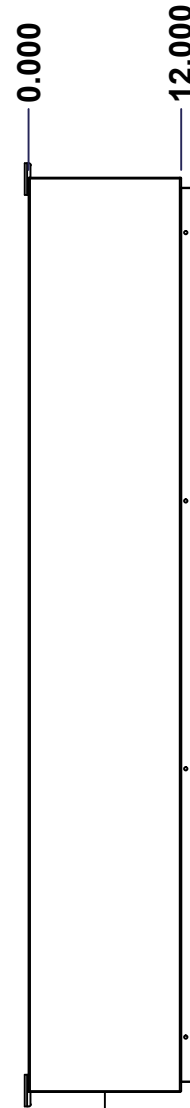

LEFT

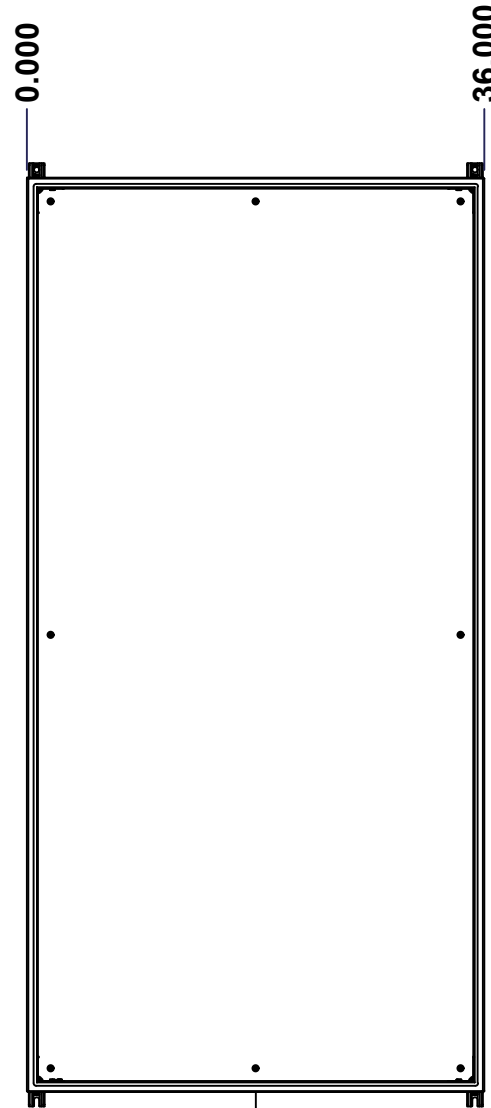

FRONT

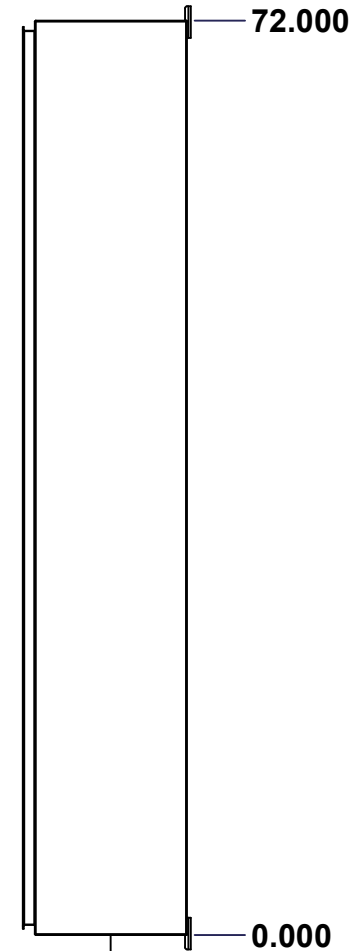

RIGHT

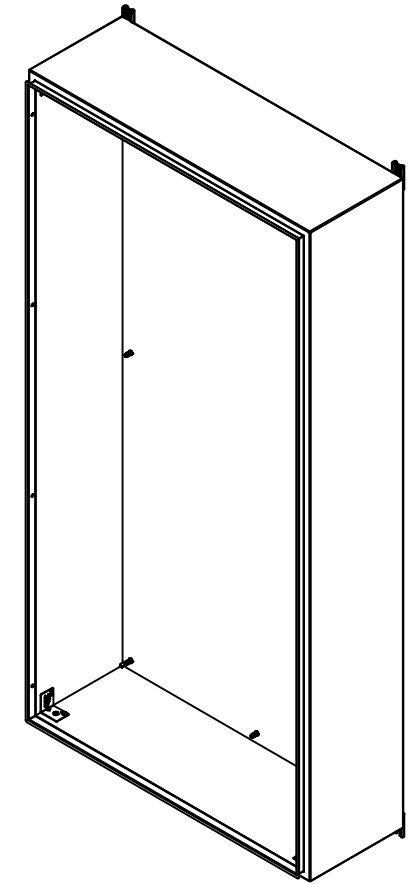

Isometric View

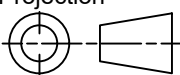

No.	Revisions	Date	By/Par

 Tél: (450) 979-4373 Fax: (450) 979-4626 <a href="http://www.exmweb.com">www.exmweb.com</a>		Flatness Aplatissement Max 5.0mm Projection 
Customer Client	Date	
Drawn By Dessiné Par	BoxCad: BoxCad	Date 02-May-23
Material Matière	14 Ga Stainless Steel 316 (1.7mm)	
Color Couleur	Asa-61 Grey	Finish Fini Smooth
Description	Detail Rev.	
5412ESSP 72" x 36" x 12" Body		
Part Number Numéro Pièce	Rev. 3	0

SEE BILL OF MATERIAL ON LAST PAGE 5412ESSP7236126THNOIPB 0 16

This drawing is confidential and must not be reproduced or used without the consent of EXM

Ce dessin est confidentiel et ne doit pas être reproduit ou utilisé sans le consentement de EXM

<b>STANDARD FEATURES ARE NOT LISTED IN THIS HOLE TABLE</b>			
<b>HOLE TABLE - TOP VIEW (CUSTOM FEATURE ONLY)</b>			
CUT-OUT	XDIM	YDIM	DESCRIPTION
1	2.000	10.500	INSUL. STUD M6 x 18mm (Inside)
2	34.000	10.500	INSUL. STUD M6 x 18mm (Inside)

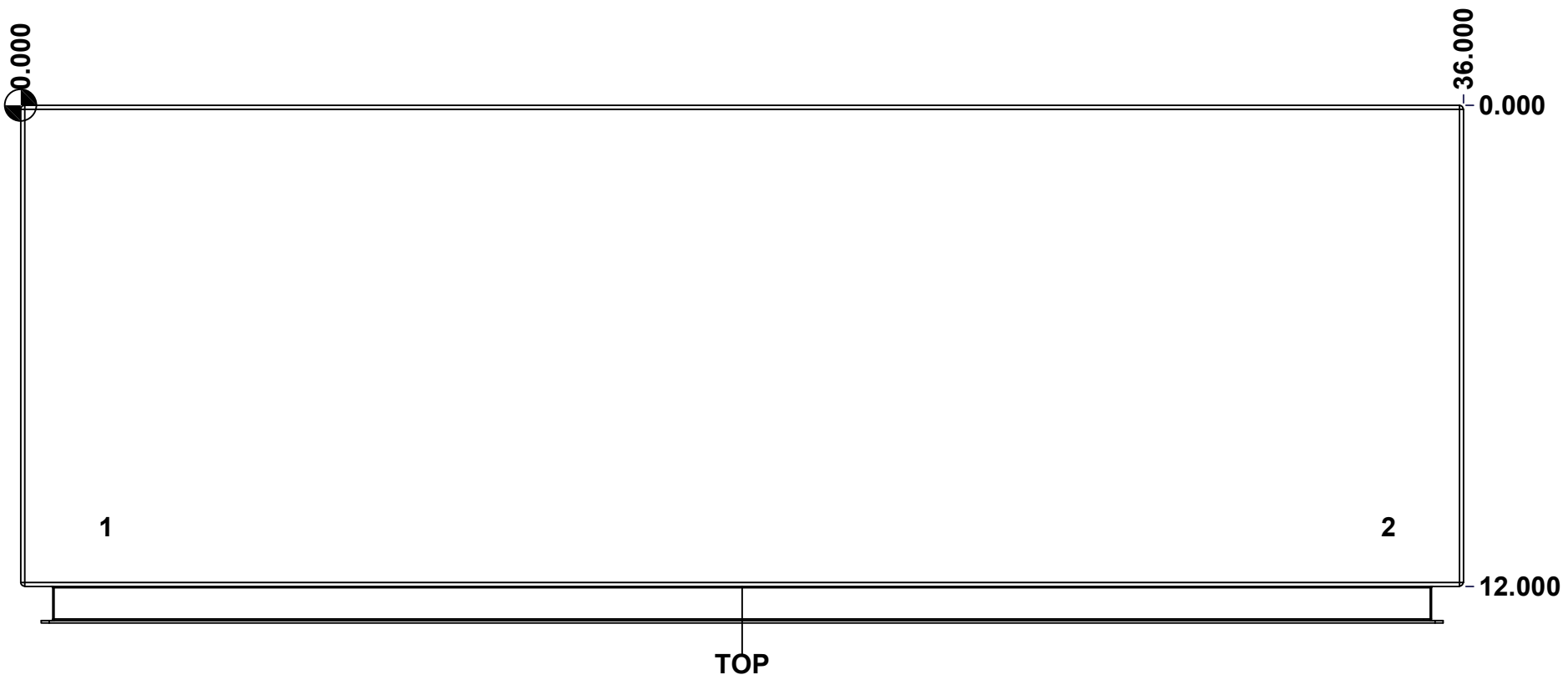

	Description	Status
	5412ESSP 72" x 36" x 12" Body	(NULL)
	Part Number Numéro Pièce	Rev.
	<b>5412ESSP7236126THNOIPB 0</b>	4
		16

This drawing is confidential and must not be reproduced or used without the consent of EXM

Ce dessin est confidentiel et ne doit pas être reproduit ou utilisé sans le consentement de EXM

<b>STANDARD FEATURES ARE NOT LISTED IN THIS HOLE TABLE</b>			
<b>HOLE TABLE - BOTTOM VIEW (CUSTOM FEATURE ONLY)</b>			
CUT-OUT	XDIM	YDIM	DESCRIPTION
1	2.000	10.500	INSUL. STUD M6 x 18mm (Inside)
2	34.000	10.500	INSUL. STUD M6 x 18mm (Inside)

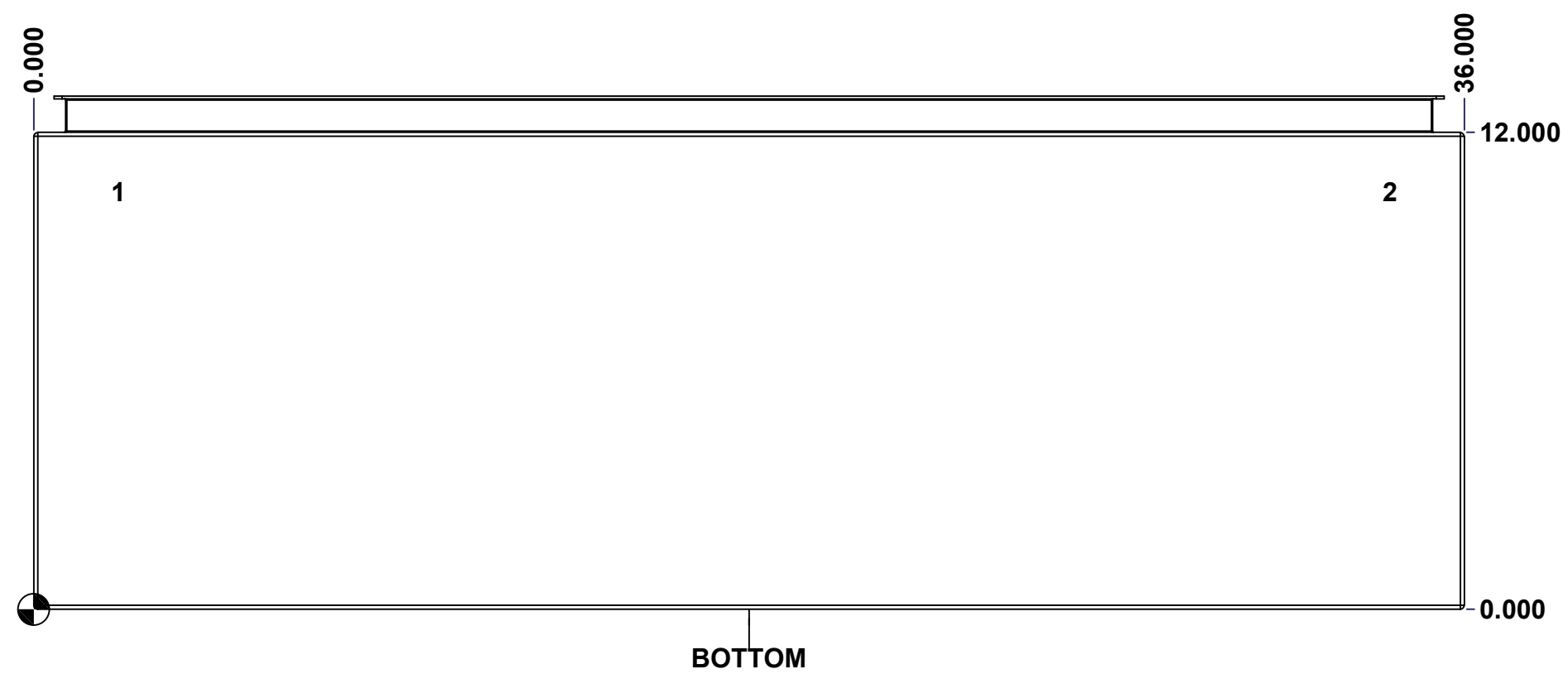

	Description	Status
	5412ESSP 72" x 36" x 12" Body	(NULL)
	Part Number Numéro Pièce	Rev. 5
	<b>5412ESSP7236126THNOIPB 0</b>	16

This drawing is confidential and must not be reproduced or used without the consent of EXM

Ce dessin est confidentiel et ne doit pas être reproduit ou utilisé sans le consentement de EXM

**STANDARD FEATURES ARE NOT LISTED IN THIS HOLE TABLE**

**HOLE TABLE - BACK VIEW (CUSTOM FEATURE ONLY)**

CUT-OUT	XDIM	YDIM	DESCRIPTION
1	1.875	1.875	IP STUD M8 x 35mm (Inside)
2	1.875	70.125	IP STUD M8 x 35mm (Inside)
3	34.125	70.125	IP STUD M8 x 35mm (Inside)
4	34.125	1.875	IP STUD M8 x 35mm (Inside)
5	1.875	36.000	IP STUD M8 x 35mm (Inside)
6	34.125	36.000	IP STUD M8 x 35mm (Inside)
7	18.000	1.875	IP STUD M8 x 35mm (Inside)
8	18.000	70.125	IP STUD M8 x 35mm (Inside)
-----			
9	35.250	0.000	FOOT 885 ESMF4_OPEN
10	0.750	0.000	FOOT 885 ESMF4_OPEN
11	35.250	72.000	FOOT 885 ESMF4_CLOSE
12	0.750	72.000	FOOT 885 ESMF4_CLOSE

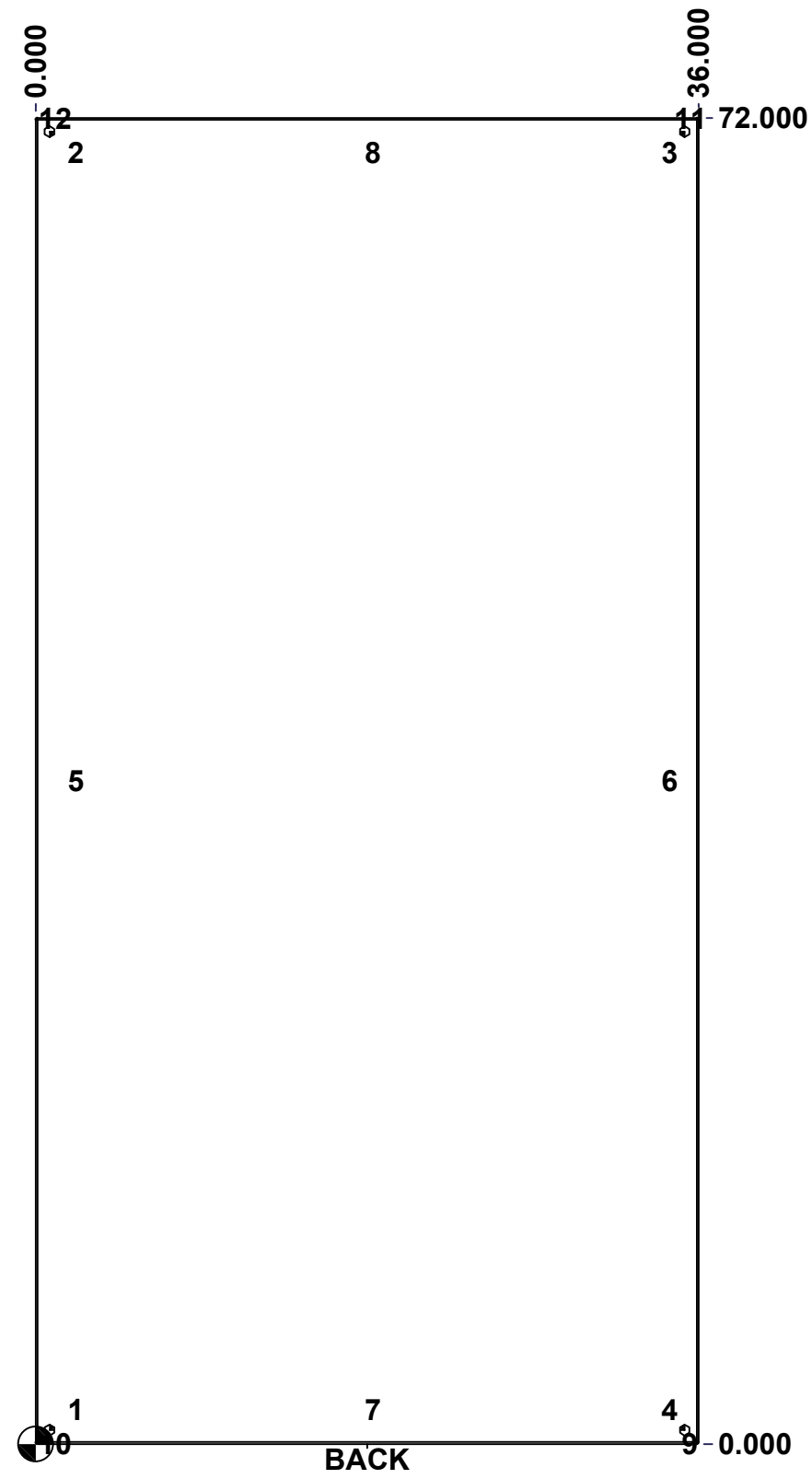

	Description	Status
	5412ESSP 72" x 36" x 12" Body	(NULL)
	Part Number Numéro Pièce	Rev.
	<b>5412ESSP7236126THNOIPB</b>	<b>0</b>
		6
		16

This drawing is confidential and must not be reproduced or used without the consent of EXM

Ce dessin est confidentiel et ne doit pas être reproduit ou utilisé sans le consentement de EXM

No.	Revisions	Date	By/Par

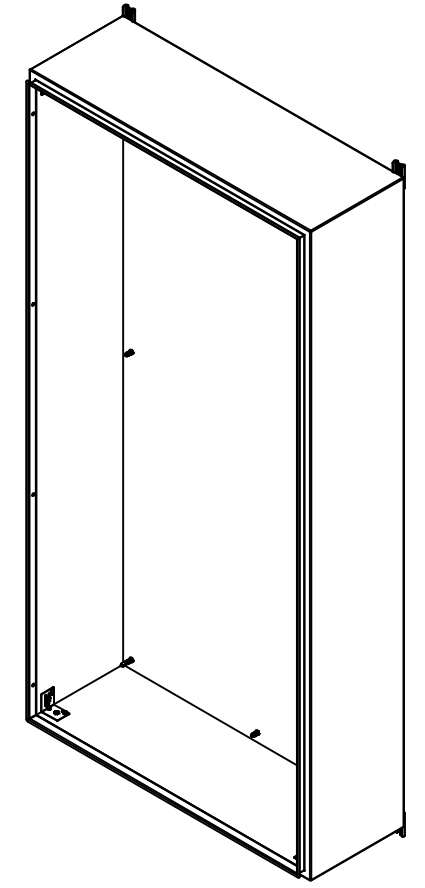

Isometric View



2	885ESMF4-FEET	0	885 ESMF4 Stainless Steel Mounting Foot
4	RIVET_NUT_SS_M10_FH_CE	0	Stainless Steel Rivet Nut M10 (Low Profile Close End)
4	STK-Q-06670	2	M10 x 16mm Stainless Steel Machine Screw
2	885ESMF4-FEET-A	0	885 ESMF4 Stainless Steel Mounting Foot (Opened Slot)
1	STK-K-70554	3	5412 ESTH Accessory Kit
1	5412ESSP7236126THNOI-PI-RS	0	5412ESSP 72" x 36" Right Insulation
1	5412ESSP7236126THNOI-PI-LS	0	5412ESSP 72" x 36" Left Insulation
1	5412ESSP7236126THNOI-PI-BT	0	5412ESSP 72" x 36" Top and Bottom Insulation
1	5412ESSP7236126THNOI-PI-TP	0	5412ESSP 72" x 36" Top and Bottom Insulation
1	5412ESSP7236126THNOI-PI-B	0	5412ESSP 72" x 36" Back Insulation
4	STK-Q-16070	1	Stud M6 x 18mm Stainless steel
1	STK-P-02400S	0	Powder Paint (Asa-61 Grey / Smooth)
8	STK-Q-16020	1	Stud M8 x 35mm Stainless Steel
1	5412ESSP7236126THNOI-PB-P	0	5412ESSP 72" x 36" x 12" Body Part

Qty	Part Number	Rev	Description
Parts List			



Tél: (450) 979-4373  
Fax: (450) 979-4626  
[www.exmweb.com](http://www.exmweb.com)

Flatness  
Aplatissement  
Max 0.0mm

Projection

Customer Client

Date

Drawn By  
Dessiné Par BoxCad: BoxCad

Date 02-May-23

Material  
Matière 14 Ga Stainless Steel 316 (1.7mm)

Color  
Couleur Asa-61 Grey

Finish  
Fini Smooth

Description

5412ESSP 72" x 36" x 12" Body

Detail Rev.

Part Number  
Numéro Pièce

**5412ESSP7236126THNOIPB**

Rev. 7

**0**

16

This drawing is confidential and must not be reproduced or used without the consent of EXM

Ce dessin est confidentiel et ne doit pas être reproduit ou utilisé sans le consentement de EXM

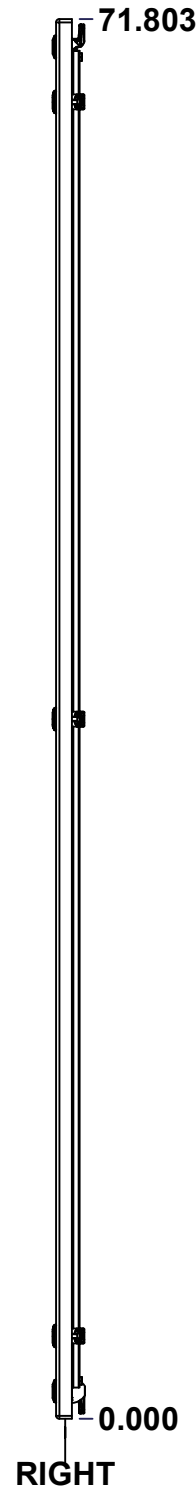
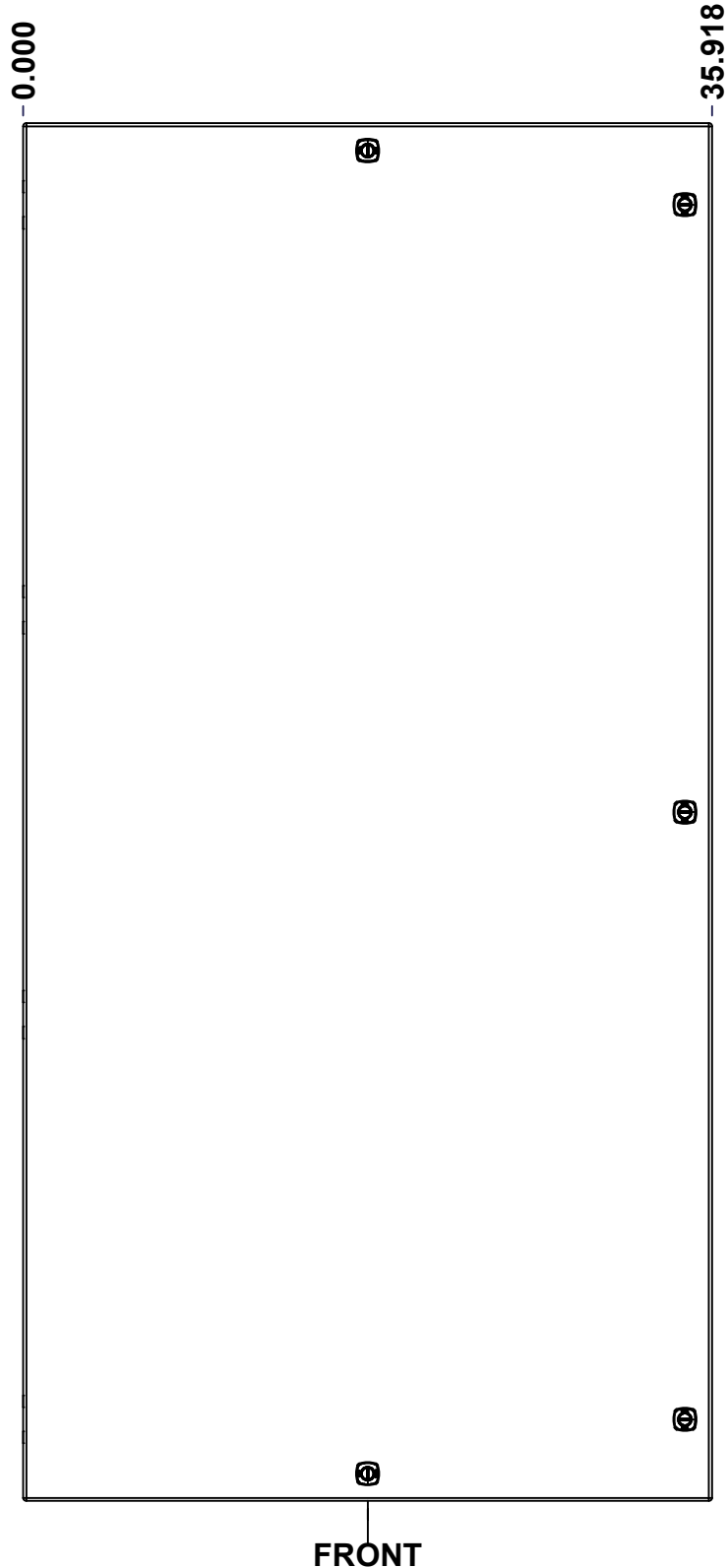
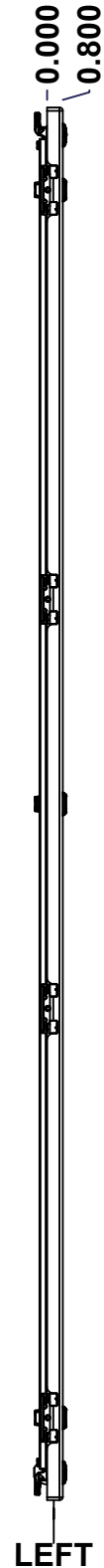
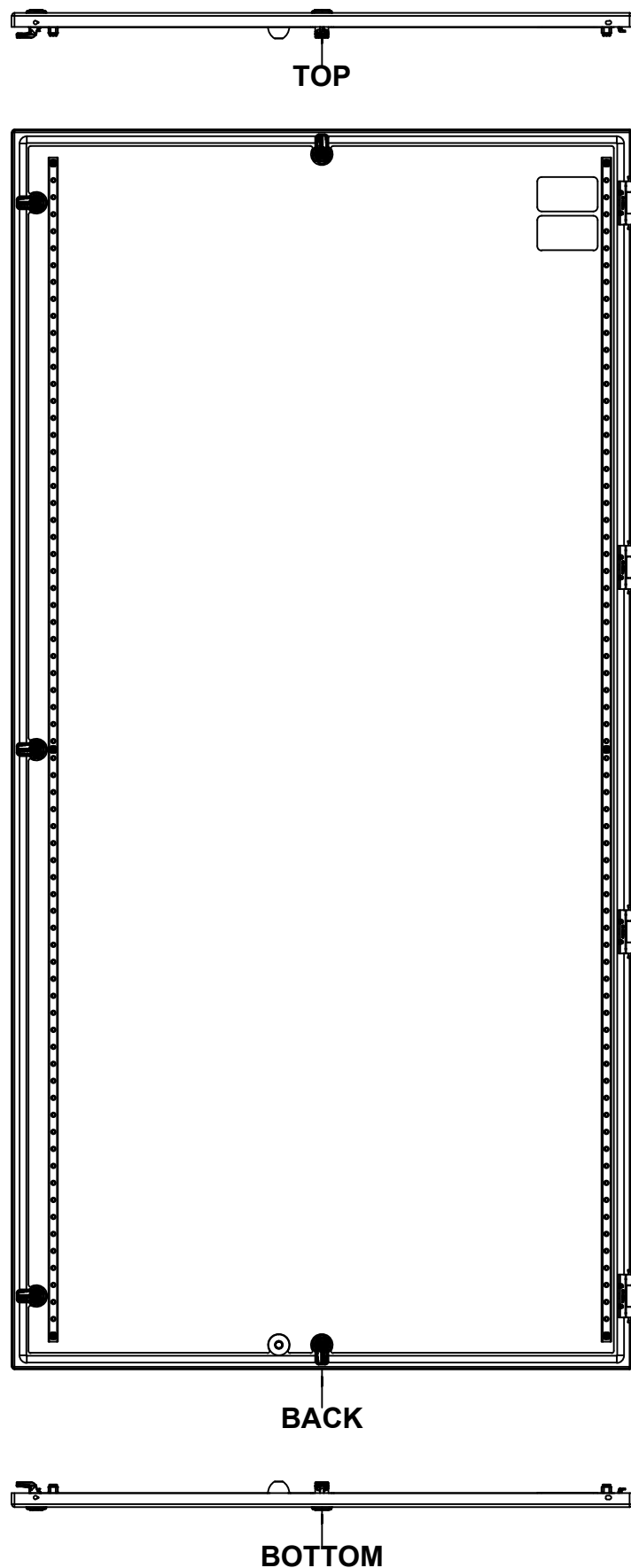

No.	Revisions	Date	By/Par

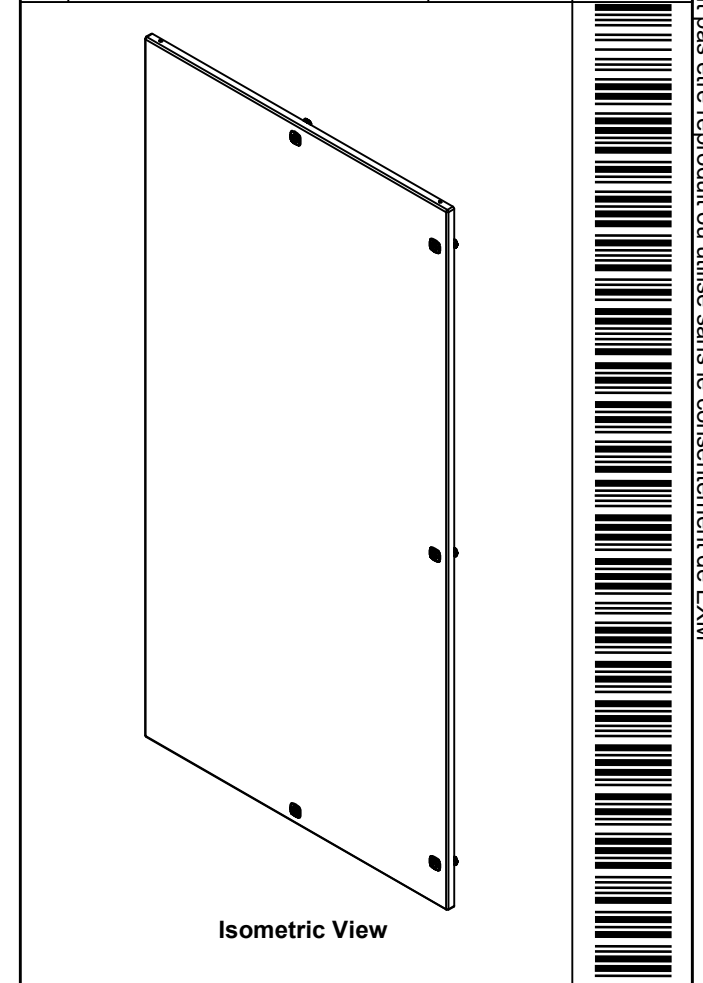

 Tél: (450) 979-4373 Fax: (450) 979-4626 <a href="http://www.exmweb.com">www.exmweb.com</a>		Flatness Aplatissement Max 5.0mm Projection 
Customer Client	Date	
Drawn By Dessiné Par	BoxCad: BoxCad	Date 02-May-23
Material Matière	14 Ga Stainless Steel 316 (1.7mm)	
Color Couleur	Asa-61 Grey	Finish Fini Smooth
Description	Detail Rev.	
5412ESSP 72" x 36" Cover		
Part Number Numéro Pièce	Rev. 8	0



This drawing is confidential and must not be reproduced or used without the consent of EXM

Ce dessin est confidentiel et ne doit pas être reproduit ou utilisé sans le consentement de EXM

**STANDARD FEATURES ARE NOT LISTED IN THIS HOLE TABLE**

**HOLE TABLE - FRONT VIEW (CUSTOM FEATURE ONLY)**

CUT-OUT	XDIM	YDIM	DESCRIPTION
1	1.486	1.945	STUD M6 x 18mm (Inside)
2	1.486	69.858	STUD M6 x 18mm (Inside)
3	33.517	69.858	STUD M6 x 18mm (Inside)
4	33.517	1.945	STUD M6 x 18mm (Inside)
5	1.486	35.902	STUD M6 x 18mm (Inside)
6	33.517	35.902	STUD M6 x 18mm (Inside)
7	20.459	1.435	STUD M6 x 18mm (Inside)
-----			
8	34.494	67.553	880 SCQ4-SLSS6
9	34.494	35.902	880 SCQ4-SLSS6
10	34.494	4.250	880 SCQ4-SLSS6
11	17.959	70.379	880 SCQ4-SLSS6
12	17.959	1.424	880 SCQ4-SLSS6

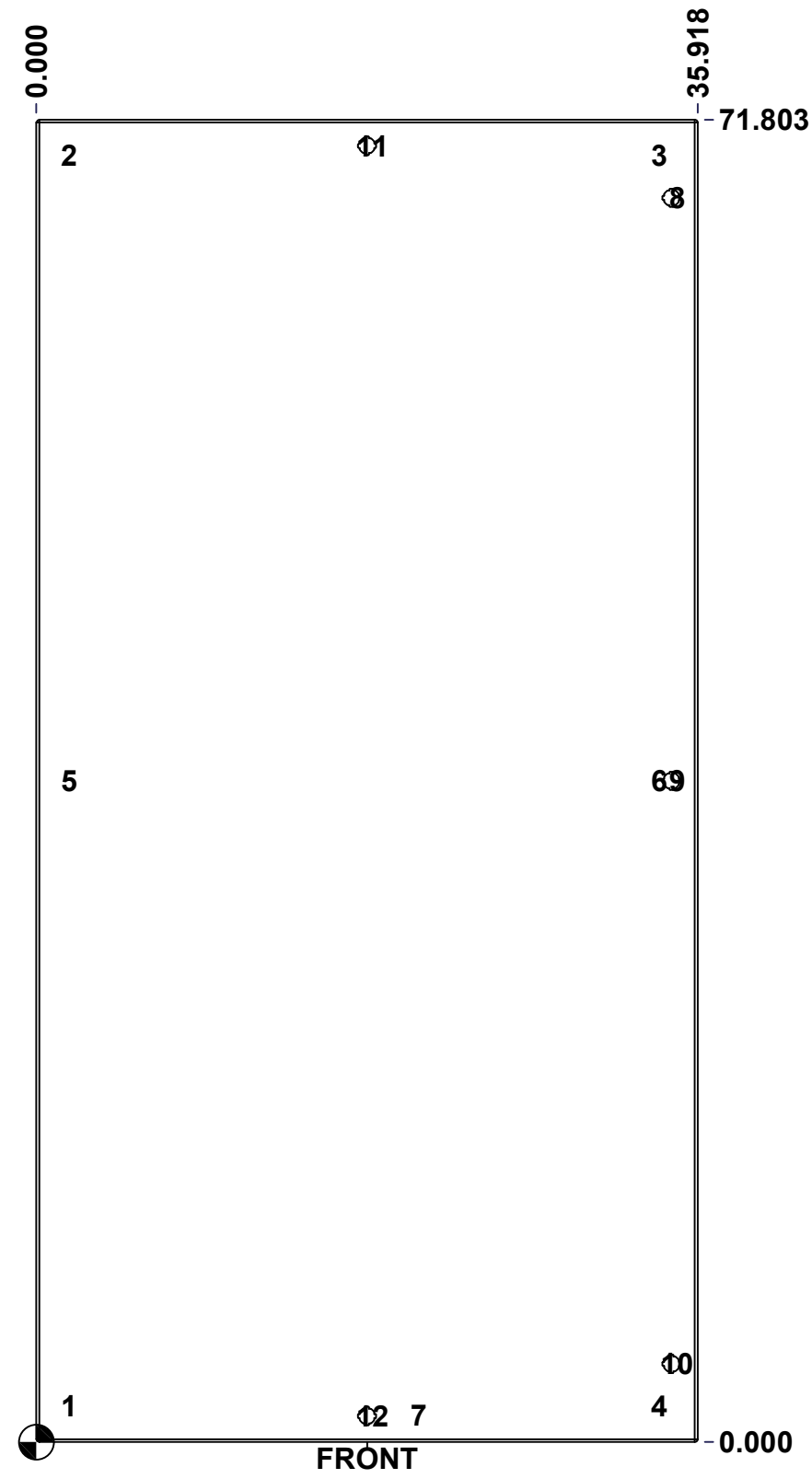

	Description	Status
	5412ESSP 72" x 36" Cover	(NULL)
	Part Number Numéro Pièce	Rev.
	5412ESSP7236126THNOIPC	9
		16

This drawing is confidential and must not be reproduced or used without the consent of EXM

Ce dessin est confidentiel et ne doit pas être reproduit ou utilisé sans le consentement de EXM

No.	Revisions	Date	By/Par

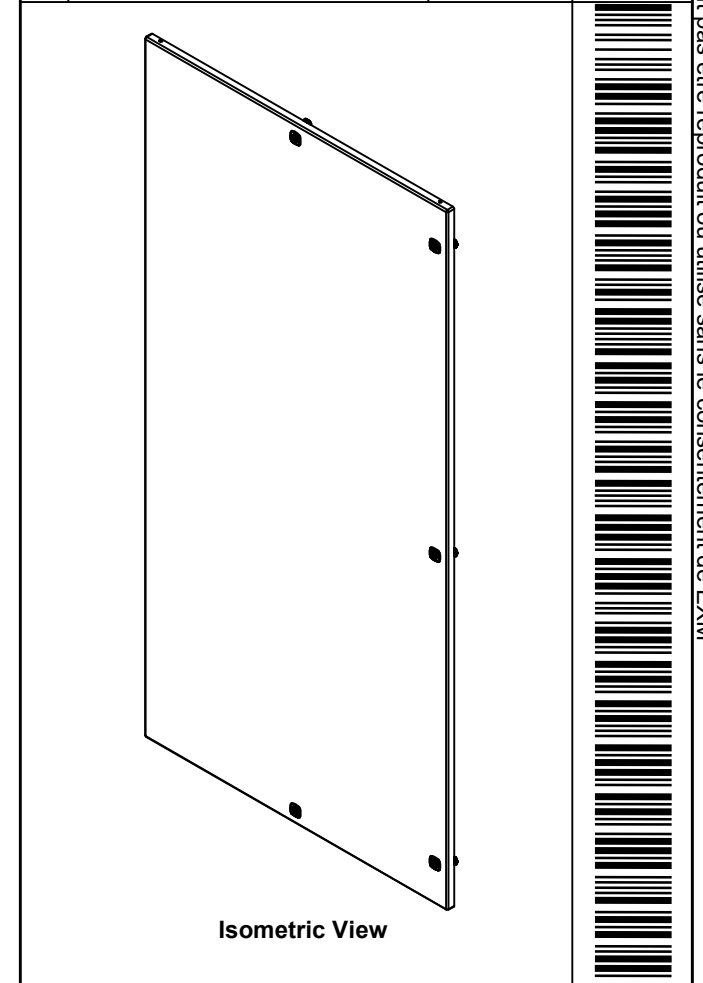

2	STK-S-00100	0	3.5" x 2" Silver Milar Flexcon Sticker
6	STK-Q-07250	2	M6 x 16mm Collar Nut
2	STK-Q-46020-72	5	5412 ES Vertical Door Stiffener 72"
1	5412ESSP7236126THNOI PI-C	0	5412ESSP 72" x 36" Cover Insulation
1	STK-P-02400S	0	Powder Paint (Asa-61 Grey / Smooth)
1	STK-Q-46515	3	5412 ES Door Support with Brass Insert
7	STK-Q-16070	1	Stud M6 x 18mm Stainless steel
1	5412ESSP7236126THNOI PG	0	5412ESSP 72" x 36" Cover Gasket Part
1	5412ESSP7236126THNOI PC-P	0	5412ESSP 72" x 36" Cover Part
5	880 SCQ4-SLSS6	7	5412 ESS 1/4 Turn Lock
4	STK-A-33016	0	5412 ESS Bended Hinge (Body Part)
QTY	Part Number	Rev	Description
Parts List			

Tél: (450) 979-4373  
Fax: (450) 979-4626  
[www.exmweb.com](http://www.exmweb.com)

Flatness  
Aplatissement  
Max 5.0mm

Projection

Customer Client	Date
Drawn By Dessiné Par BoxCad: BoxCad	Date 02-May-23
Material Matière 14 Ga Stainless Steel 316 (1.7mm)	
Color Couleur Asa-61 Grey	Finish Fini Smooth
Description 5412ESSP 72" x 36" Cover	Detail Rev.
Part Number Numéro Pièce <b>5412ESSP7236126THNOIPC</b>	Rev. 0

This drawing is confidential and must not be reproduced or used without the consent of EXM

Ce dessin est confidentiel et ne doit pas être reproduit ou utilisé sans le consentement de EXM

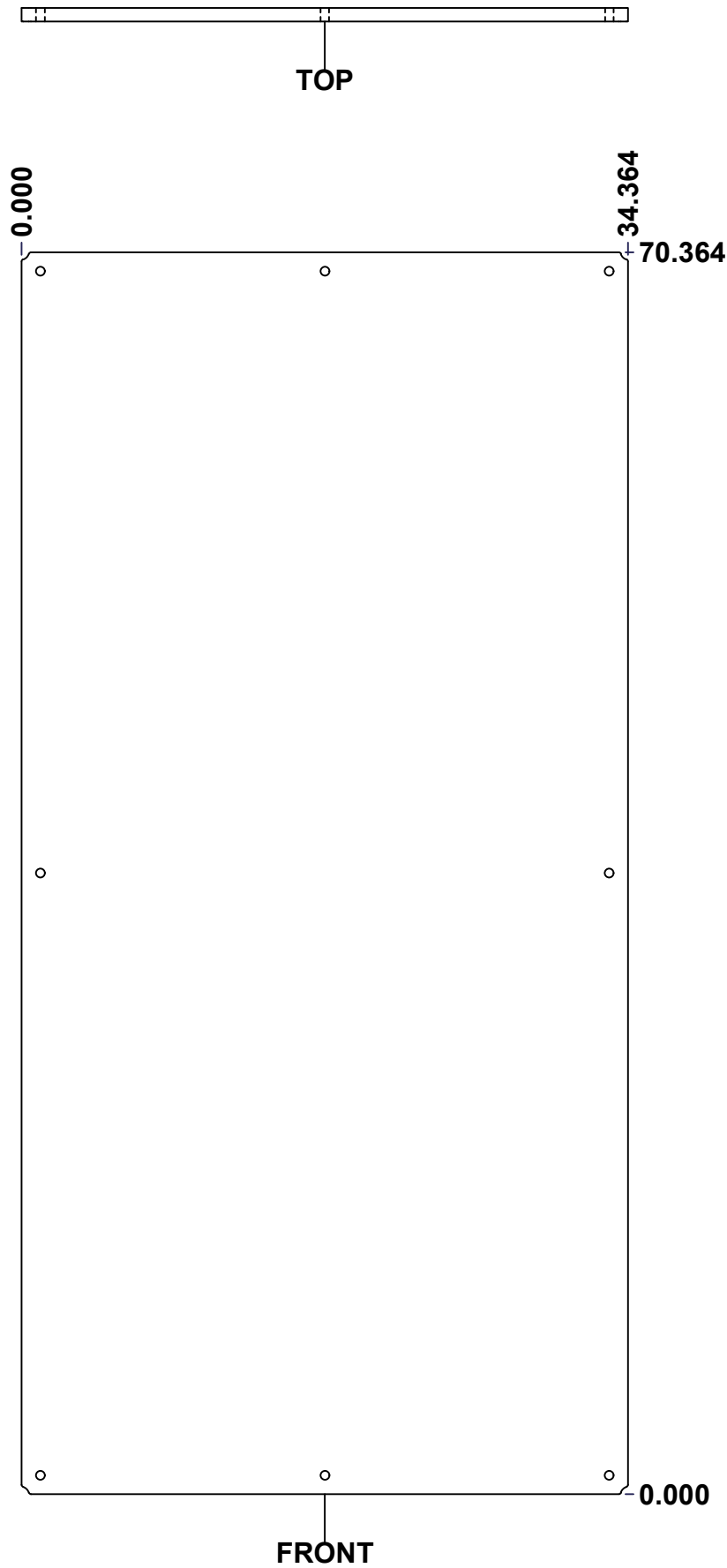

No.	Revisions	Date	By/Par

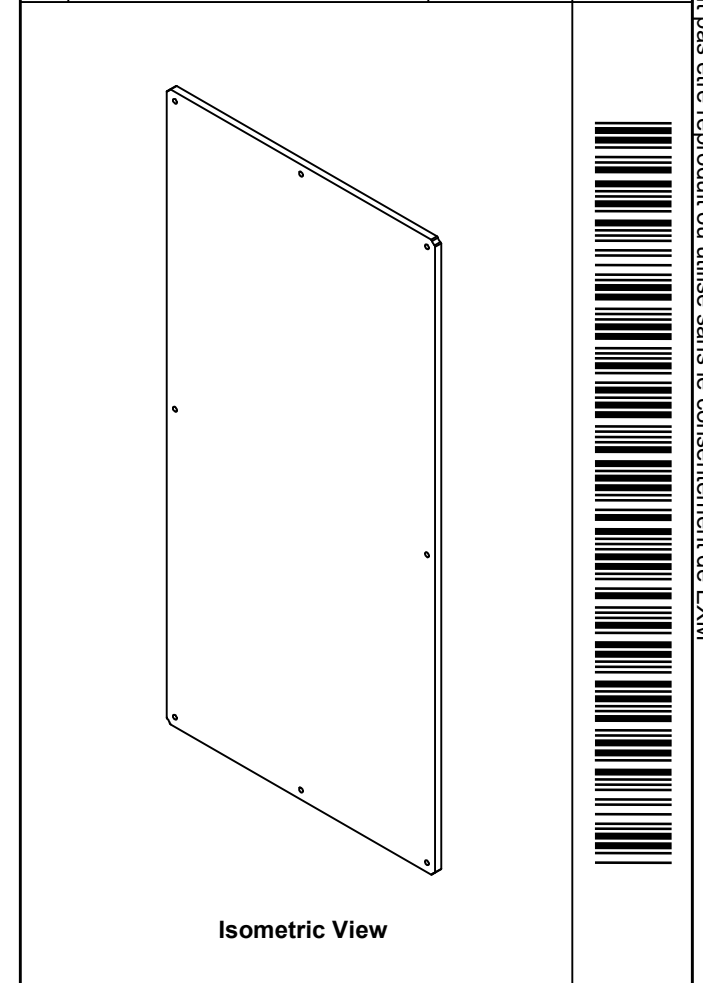

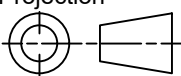
 Tél: (450) 979-4373 Fax: (450) 979-4626 <a href="http://www.exmweb.com">www.exmweb.com</a>		Flatness Aplatissement Max 3.0mm
Customer Client		Projection 
Drawn By / Dessiné Par: BoxCad: Patrick Deschenes		Date: 23-Jan-07
Material / Matière: Polyisocyanurate		
Color / Couleur: Aluminum	Finish / Fini: N/A	
Description: 5412ESSP 72" x 36" Back Insulation		Detail Rev.
Part Number / Numéro Pièce: 5412ESSP7236126THNOIP-B		Rev. 11

SEE BILL OF MATERIAL ON LAST PAGE 5412ESSP7236126THNOIP-B 0

This drawing is confidential and must not be reproduced or used without the consent of EXM

Ce dessin est confidentiel et ne doit pas être reproduit ou utilisé sans le consentement de EXM

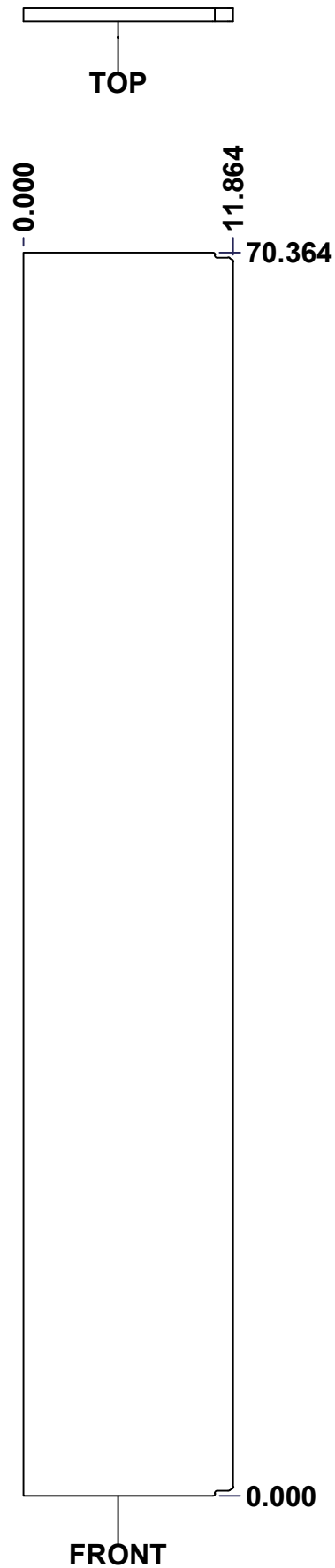

No.	Revisions	Date	By/Par

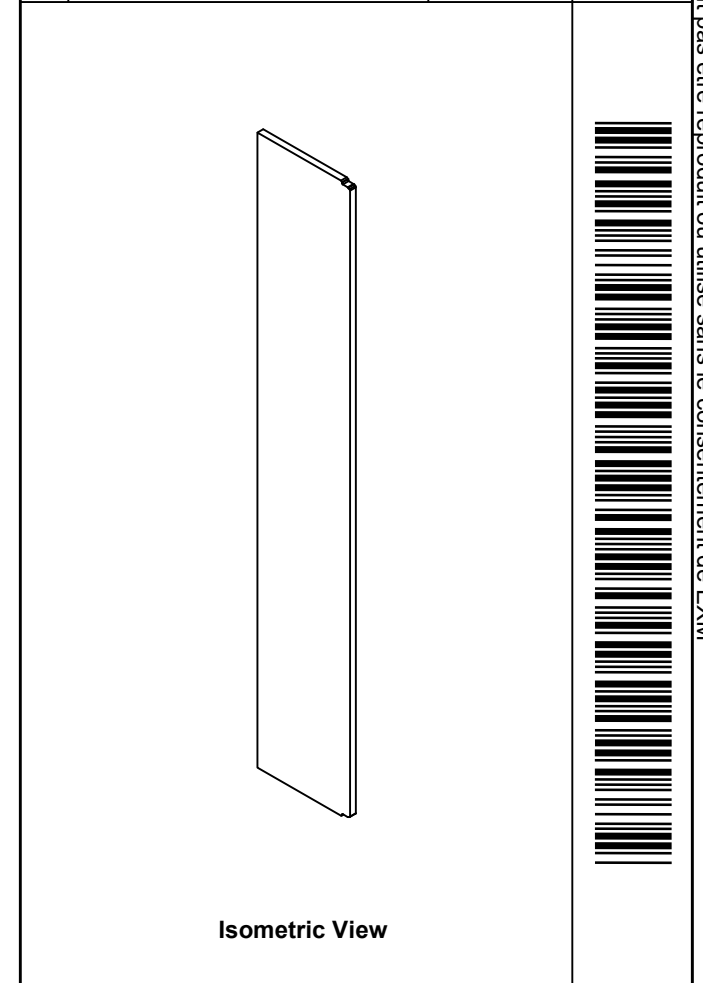

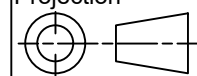
 Tél: (450) 979-4373 Fax: (450) 979-4626 <a href="http://www.exmweb.com">www.exmweb.com</a>		Flatness Aplatissement Max 3.0mm
Projection 		Date 23-Jan-07
Customer Client	Date	
Drawn By Dessiné Par	BoxCad: Patrick Deschenes	Date 23-Jan-07
Material Matière	Polyisocyanurate	
Color Couleur	Aluminum	Finish Fini N/A
Description	Detail Rev.	
5412ESSP 72" x 36" Left Insulation		
Part Number Numéro Pièce	Rev.	12
5412ESSP7236126THNOIPI-LS 0		16

SEE BILL OF MATERIAL ON LAST PAGE

This drawing is confidential and must not be reproduced or used without the consent of EXM

Ce dessin est confidentiel et ne doit pas être reproduit ou utilisé sans le consentement de EXM

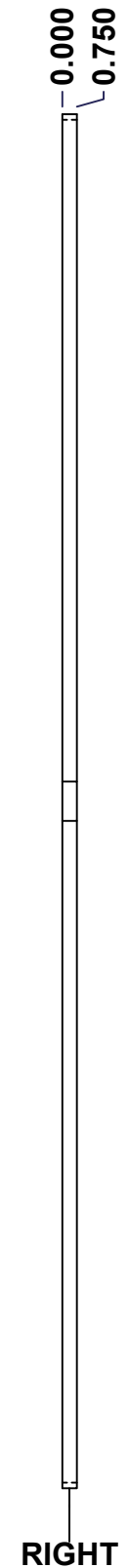
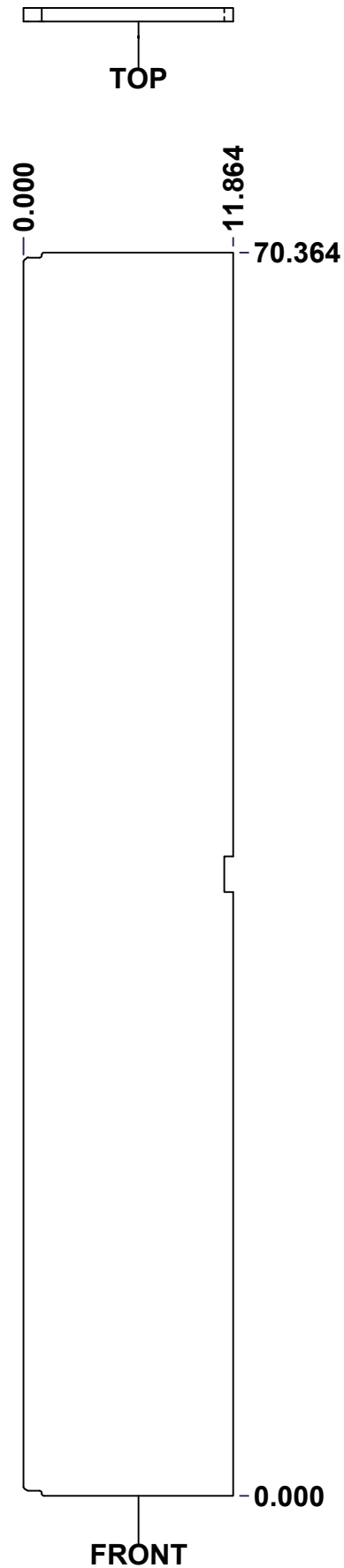

Isometric View

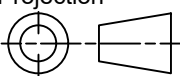

No.	Revisions	Date	By/Par

 Tél: (450) 979-4373 Fax: (450) 979-4626 <a href="http://www.exmweb.com">www.exmweb.com</a>		Flatness Aplatissement Max 3.0mm
Customer Client		Projection 
Drawn By / Dessiné Par: BoxCad: Patrick Deschenes		Date: 23-Jan-07
Material / Matière: Polyisocyanurate		
Color / Couleur: Aluminum	Finish / Fini: N/A	
Description: 5412ESSP 72" x 36" Right Insulation		Detail Rev.
Part Number / Numéro Pièce: 5412ESSP7236126THNOIP-RS 0		Rev. 13

SEE BILL OF MATERIAL ON LAST PAGE

This drawing is confidential and must not be reproduced or used without the consent of EXM

Ce dessin est confidentiel et ne doit pas être reproduit ou utilisé sans le consentement de EXM

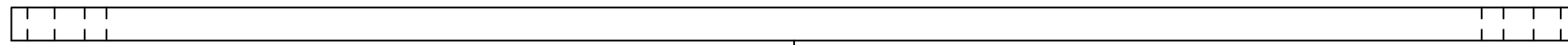

TOP

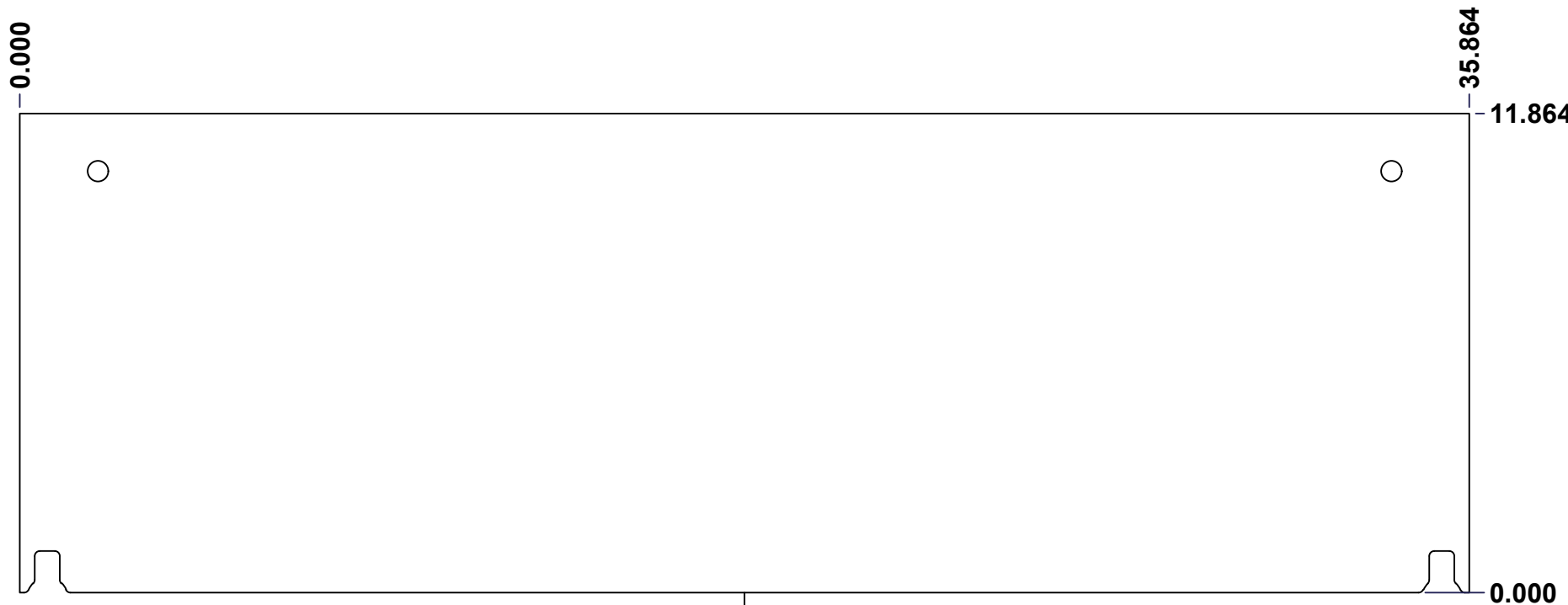

FRONT

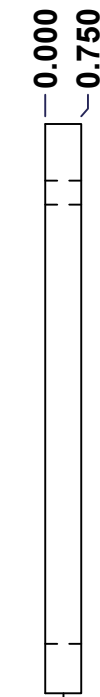

RIGHT

No.	Revisions	Date	By/Par

**Isometric View**

Tél: (450) 979-4373 Fax: (450) 979-4626 <a href="http://www.exmweb.com">www.exmweb.com</a>		Flatness Aplatissement	
		Max 3.0mm	
Customer Client		Date	
Drawn By Dessiné Par		Date	
Material Matière		Polyisocyanurate	
Color Couleur		Finish Fini	
Description		Detail Rev.	
Part Number Numéro Pièce		Rev.	

SEE BILL OF MATERIAL ON LAST PAGE 5412ESSP7236126THNOIPI-TP 0

This drawing is confidential and must not be reproduced or used without the consent of EXM

Ce dessin est confidentiel et ne doit pas être reproduit ou utilisé sans le consentement de EXM

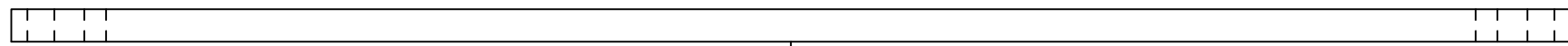

TOP

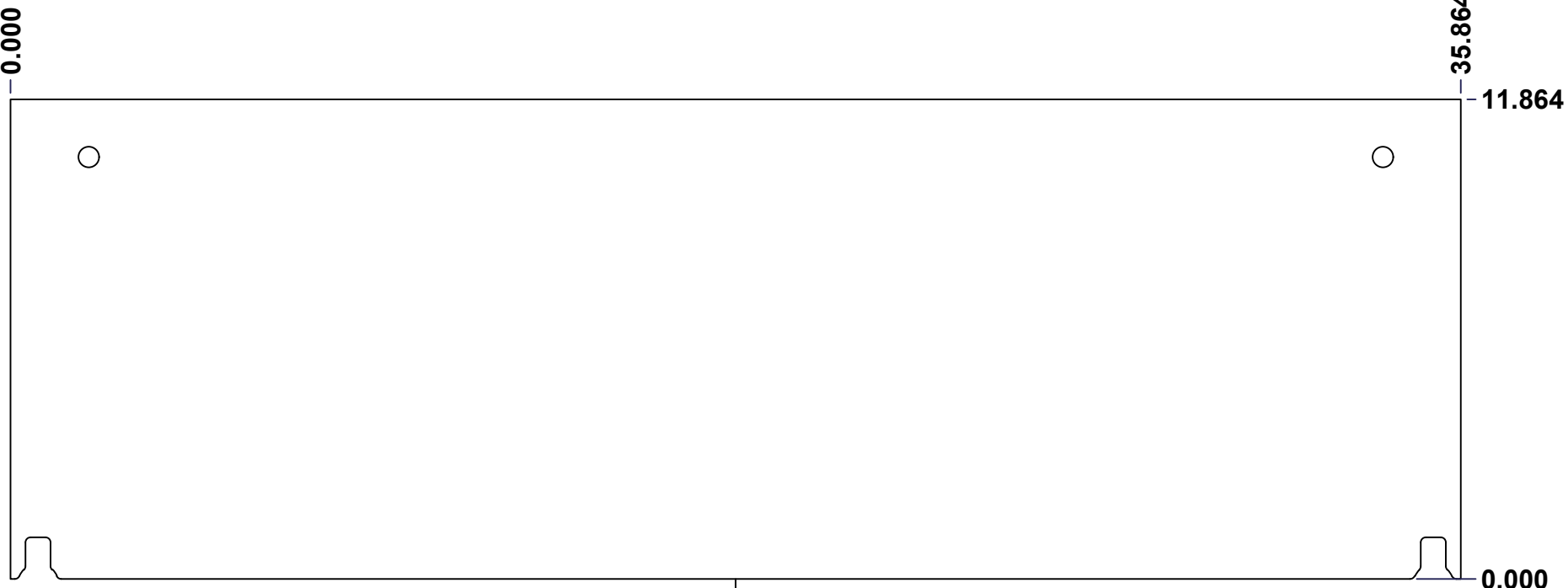

FRONT

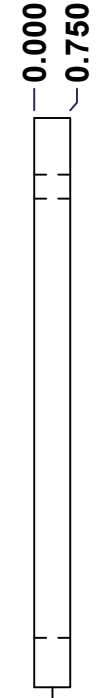

RIGHT

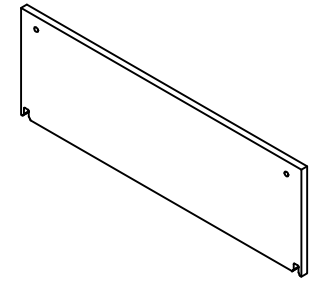

Isometric View

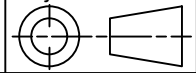

No.	Revisions	Date	By/Par

 Tél: (450) 979-4373 Fax: (450) 979-4626 <a href="http://www.exmweb.com">www.exmweb.com</a>		Flatness Aplatissement Max 3.0mm Projection 
Customer Client	Date	
Drawn By Dessiné Par	BoxCad: Patrick Deschenes	Date 23-Jan-07
Material Matière	Polyisocyanurate	
Color Couleur	Aluminum	Finish Fini N/A
Description	Detail Rev.	
5412ESSP 72" x 36" Top and Bottom Insulation		
Part Number Numéro Pièce	Rev.	15
5412ESSP7236126THNOIPI-BT 0		16

SEE BILL OF MATERIAL ON LAST PAGE

This drawing is confidential and must not be reproduced or used without the consent of EXM

Ce dessin est confidentiel et ne doit pas être reproduit ou utilisé sans le consentement de EXM

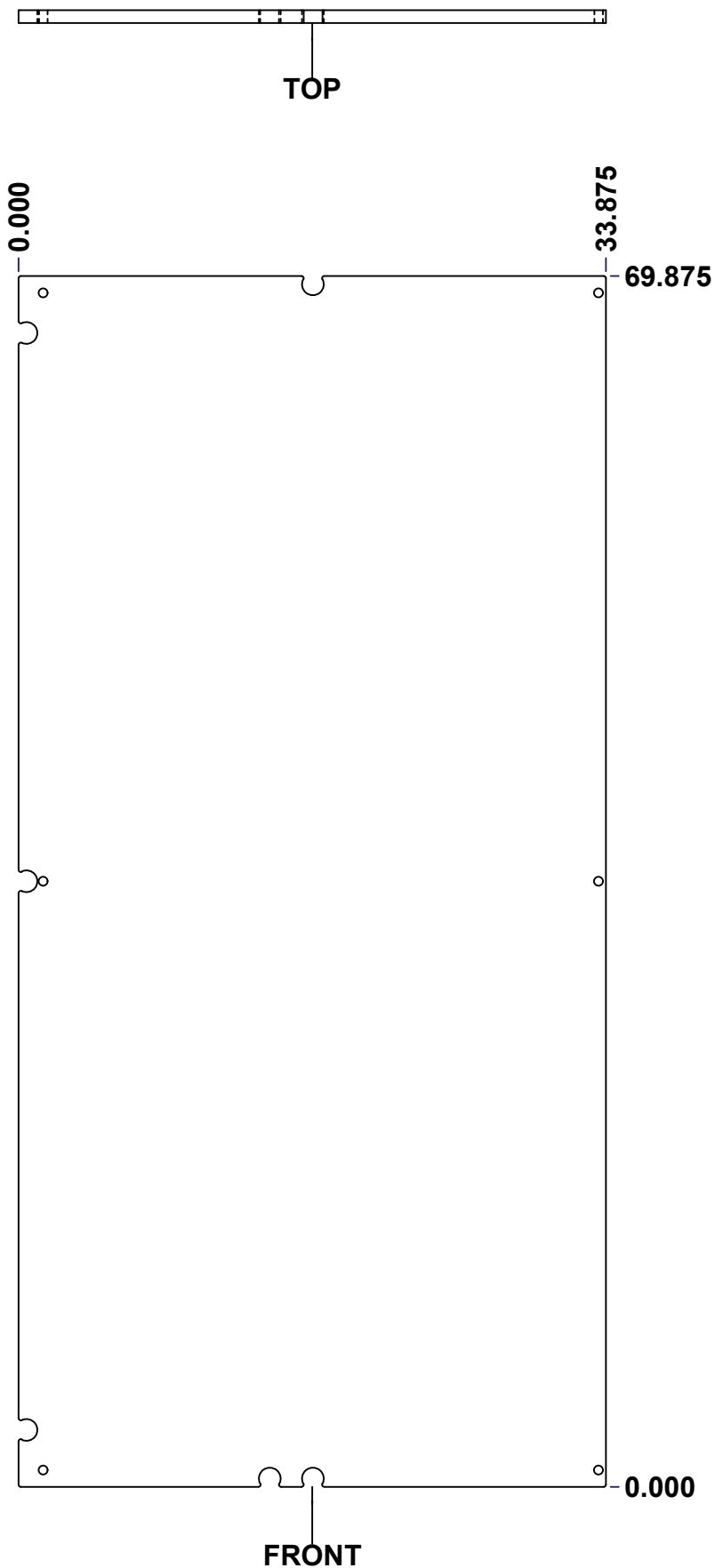

0.000  
0.750

No.	Revisions	Date	By/Par

**Isometric View**

Tél: (450) 979-4373 Fax: (450) 979-4626 <a href="http://www.exmweb.com">www.exmweb.com</a>		Flatness Aplatissement Max 3.0mm Projection 
Customer Client	Date	
Drawn By Dessiné Par	BoxCad: Patrick Deschenes	Date 23-Jan-07
Material Matière	Polyisocyanurate	
Color Couleur	Aluminum	Finish Fini N/A
Description	Detail Rev.	
5412ESSP 72" x 36" Cover Insulation		
Part Number Numéro Pièce	Rev.	16
5412ESSP7236126THNOIP-C	0	16

SEE BILL OF MATERIAL ON LAST PAGE