

This drawing is confidential and must not be reproduced or used without the consent of EXM

Ce dessin est confidentiel et ne doit pas être reproduit ou utilisé sans le consentement de EXM

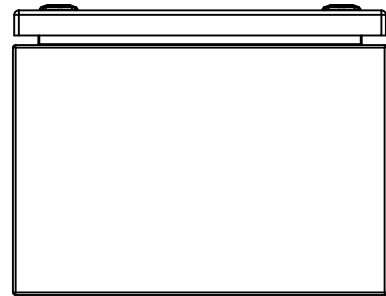

TOP

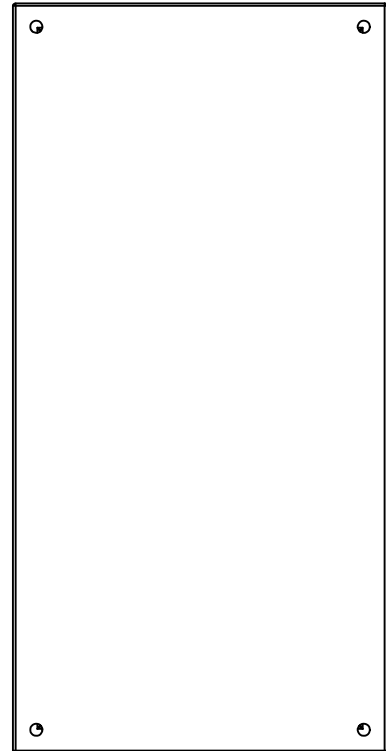

BACK

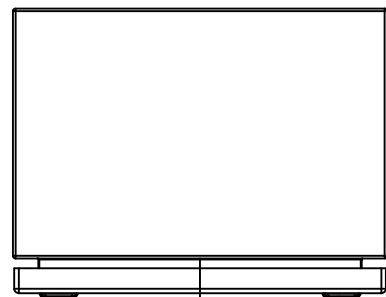

BOTTOM

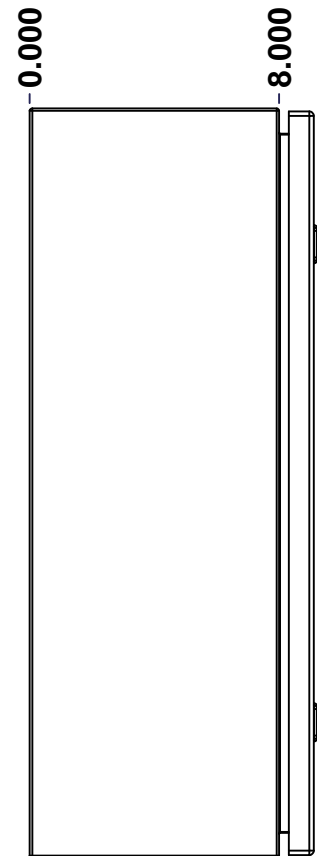

LEFT

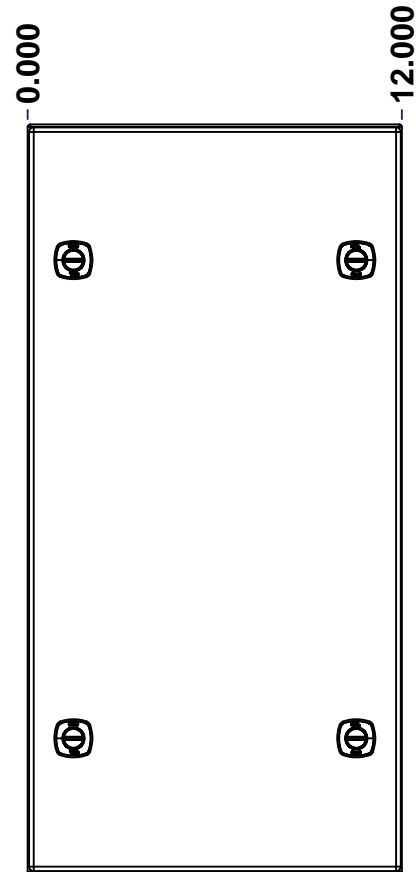

FRONT

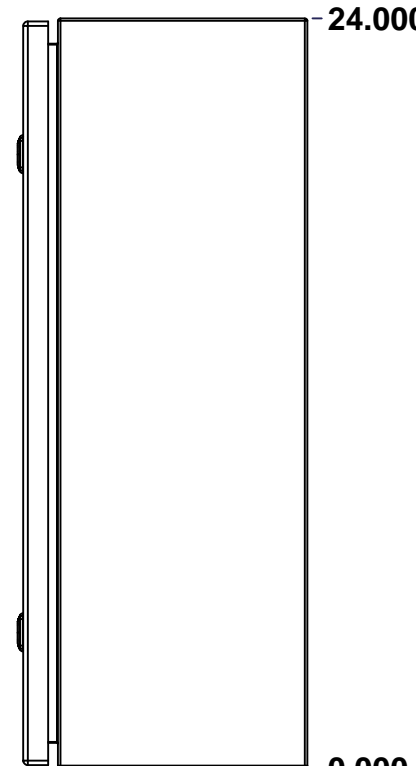

RIGHT

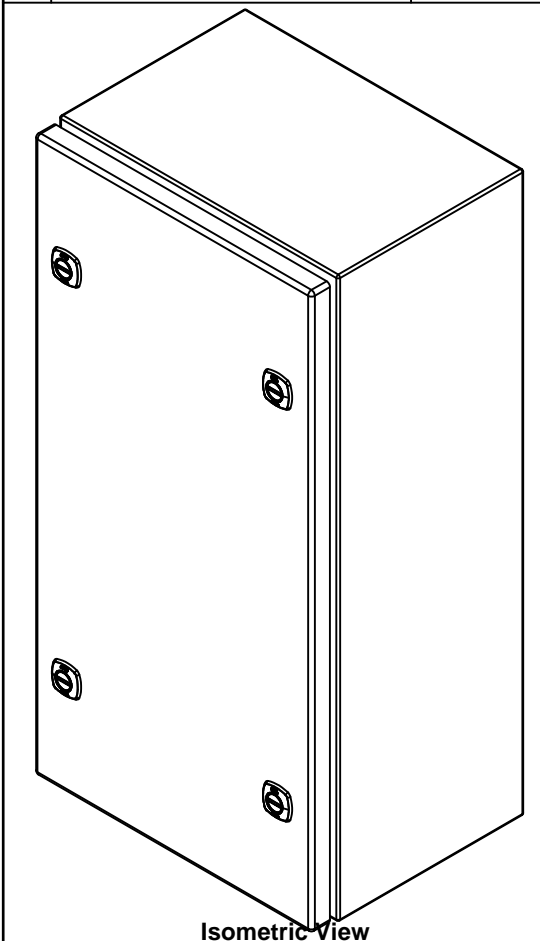

Isometric View



**GRAIN DIRECTION:
TOP/BOTTOM: HORIZONTAL
LEFT/RIGHT/BACK/FRONT: VERTICAL**

SEE BILL OF MATERIAL ON LAST PAGE

| No. | Revisions | Date | By/Par |
|-----|-----------|------|--------|
| | | | |
| | | | |
| | | | |
| | | | |
| | | | |

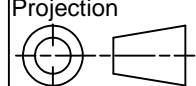
| | | |
|--|-----------------------------------|---|
|  Tél: (450) 979-4373 Fax: (450) 979-4626 www.exmweb.com | | Flatness Aplatissement Max 3.0mm Projection  |
| Customer Client | Date | Date 19-May-14 |
| Drawn By Dessiné Par | BoxCad: BoxCad | |
| Material Matière | 16 Ga Stainless Steel 304 (1.4mm) | |
| Color Couleur | Unpainted | Finish Fini Brushed |
| Description | Detail Rev. | |
| 5412ESSQT 24" x 12" x 8" Assembly | | |
| Part Number Numéro Pièce | Rev. | 1 |
| 5412ESSQT241208 | 0 | 2 |

This drawing is confidential and must not be reproduced or used without the consent of EXM

Ce dessin est confidentiel et ne doit pas être reproduit ou utilisé sans le consentement de EXM

| NOTE | |
|------|--|
| ITEM | DESCRIPTION |
| 1 | NEMA 4X Enclosure |
| 2 | C/W Standard ground studs on box and cover |
| 3 | C/W Standard door stiffener |
| 4 | C/W Standard inner panel (Included) |
| 5 | C/W Standard inner panel mounting studs |

| No. | Revisions | Date | By/Par |
|-----|-----------|------|--------|
| | | | |
| | | | |
| | | | |
| | | | |
| | | | |
| | | | |

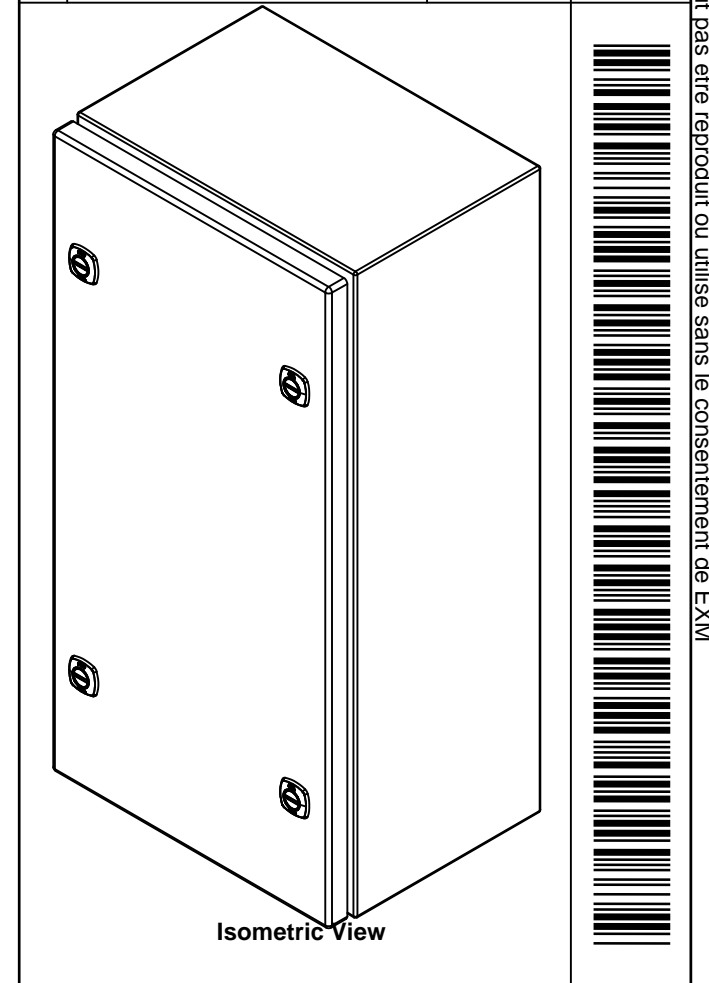

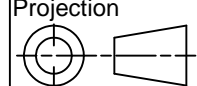
| | | |
|--|-----------------------------------|---|
|  Tél: (450) 979-4373 Fax: (450) 979-4626 www.exmweb.com | | Flatness Aplatissement Max 3.0mm Projection  |
| Customer Client | Date | |
| Drawn By Dessiné Par | BoxCad: BoxCad | Date 19-May-14 |
| Material Matière | 16 Ga Stainless Steel 304 (1.4mm) | |
| Color Couleur | Unpainted | Finish Fini Brushed |
| Description | | Detail Rev. |
| 5412ESSQT 24" x 12" x 8" Assembly | | |
| Part Number Numéro Pièce | 5412ESSQT241208 | Rev. 2 |
| | | 0 |

| PACKING | | |
|-----------------------|-----|--|
| ITEM | QTY | DESCRIPTION |
| Cardboard sleeve | 2 | Top and Bottom |
| Cardboard strip | 2 | Between back of enclosure and inner panel |
| Plastic bag | 1 | To protect cover surface and inside gasket |
| Plastic strap - Black | 2 | To Squeeze the 2 cardboard sleeve together |
| Packaging label | 1 | White label with product number |

| Qty | Part Number | Rev | Description |
|------------|------------------|-----|-------------------------------|
| 1 | STK-K-01800 | 5 | 5412 ES Accessory Kit |
| 1 | 881 SP2412G | 0 | 881 SP - Inner Panel |
| 1 | 5412ESSQT241208C | 0 | 5412ESSQT 24" x 12" Cover |
| 4 | STK-Q-07310 | 2 | Flange Lock Nut M8 |
| 4 | STK-Q-07610 | 8 | M8 Plastic Spacer 22.2mm |
| 1 | 5412ESSQT241208B | 0 | 5412ESSQT 24" x 12" x 8" Body |
| Parts List | | | |

This drawing is confidential and must not be reproduced or used without the consent of EXM

Ce dessin est confidentiel et ne doit pas être reproduit ou utilisé sans le consentement de EXM

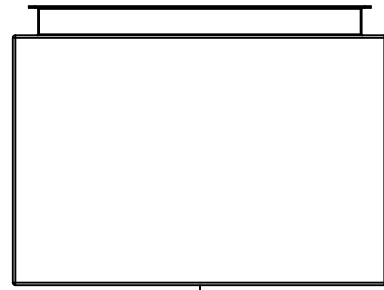

TOP

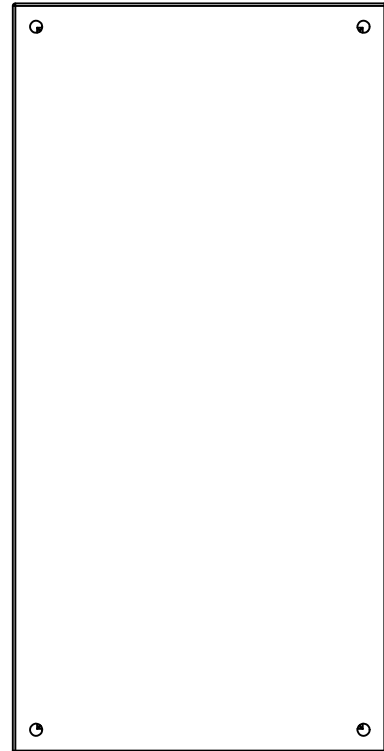

BACK

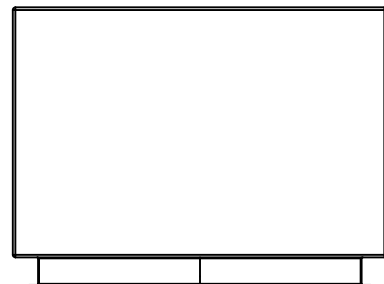

BOTTOM

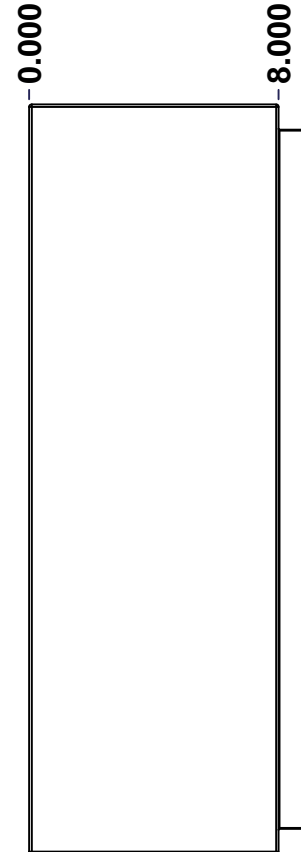

LEFT

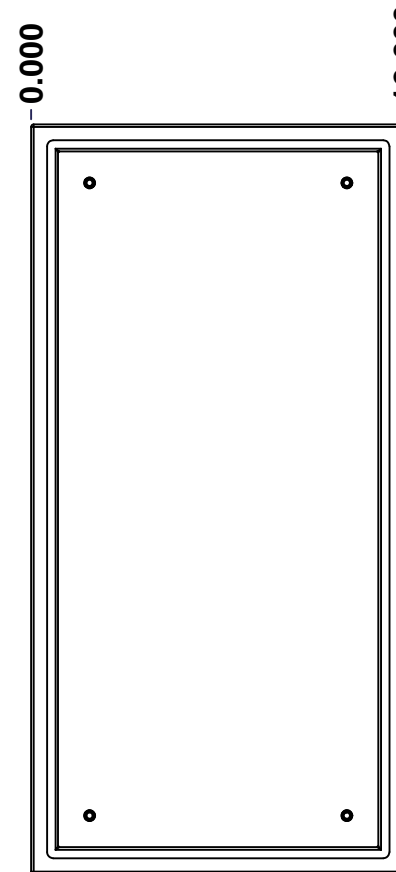

FRONT

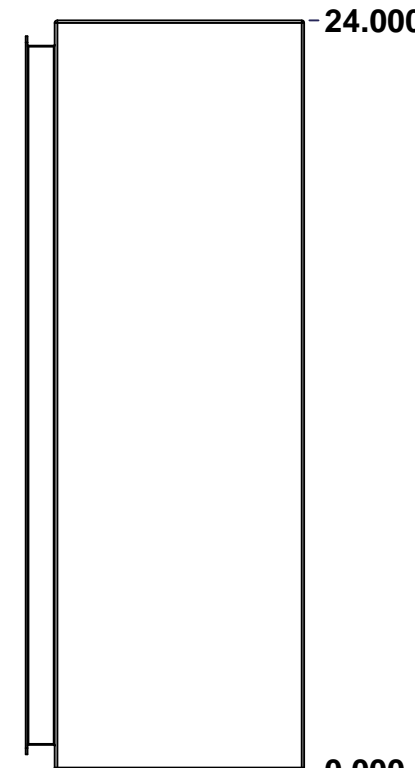

RIGHT

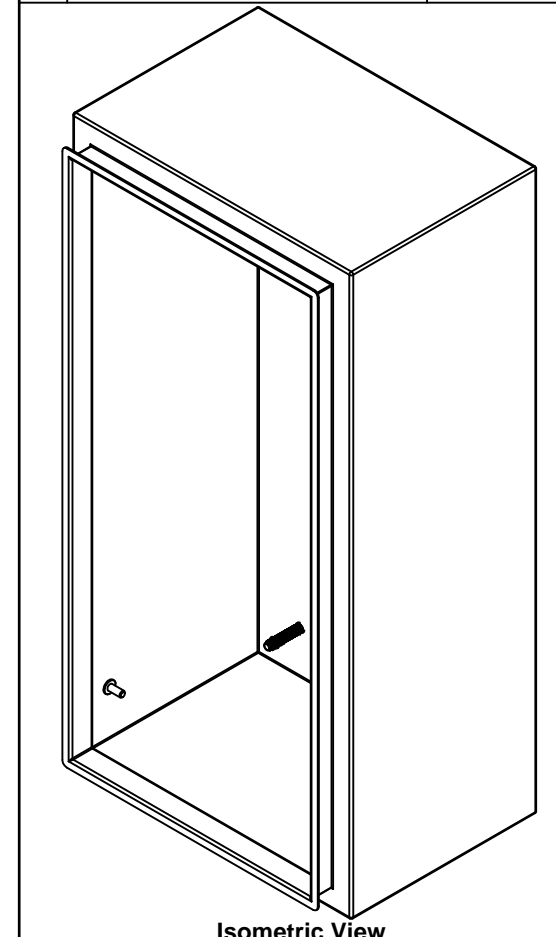

Isometric View

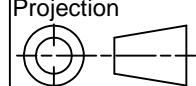

| No. | Revisions | Date | By/Par |
|-----|-----------|------|--------|
| | | | |
| | | | |
| | | | |
| | | | |
| | | | |

| | | |
|--|-----------------------------------|---|
|  Tél: (450) 979-4373 Fax: (450) 979-4626 www.exmweb.com | | Flatness Aplatissement Max 3.0mm Projection  |
| Customer Client | Date | Date 19-May-14 |
| Drawn By Dessiné Par | BoxCad: BoxCad | |
| Material Matière | 16 Ga Stainless Steel 304 (1.4mm) | |
| Color Couleur | Unpainted | Finish Fin Brushed |
| Description | Detail Rev. | |
| 5412ESSQT 24" x 12" x 8" Body | | |
| Part Number Numéro Pièce | Rev. | 1 7 |
| 5412ESSQT241208B | 0 | |

SEE BILL OF MATERIAL ON LAST PAGE

This drawing is confidential and must not be reproduced or used without the consent of EXM

Ce dessin est confidentiel et ne doit pas être reproduit ou utilisé sans le consentement de EXM

| STANDARD FEATURES ARE NOT LISTED IN THIS HOLE TABLE | | | |
|--|-------|-------|-----------------------------|
| HOLE TABLE - LEFT VIEW (CUSTOM FEATURE ONLY) | | | |
| CUT-OUT | XDIM | YDIM | DESCRIPTION |
| 1 | 6.500 | 2.000 | GND STUD M6 x 16mm (Inside) |

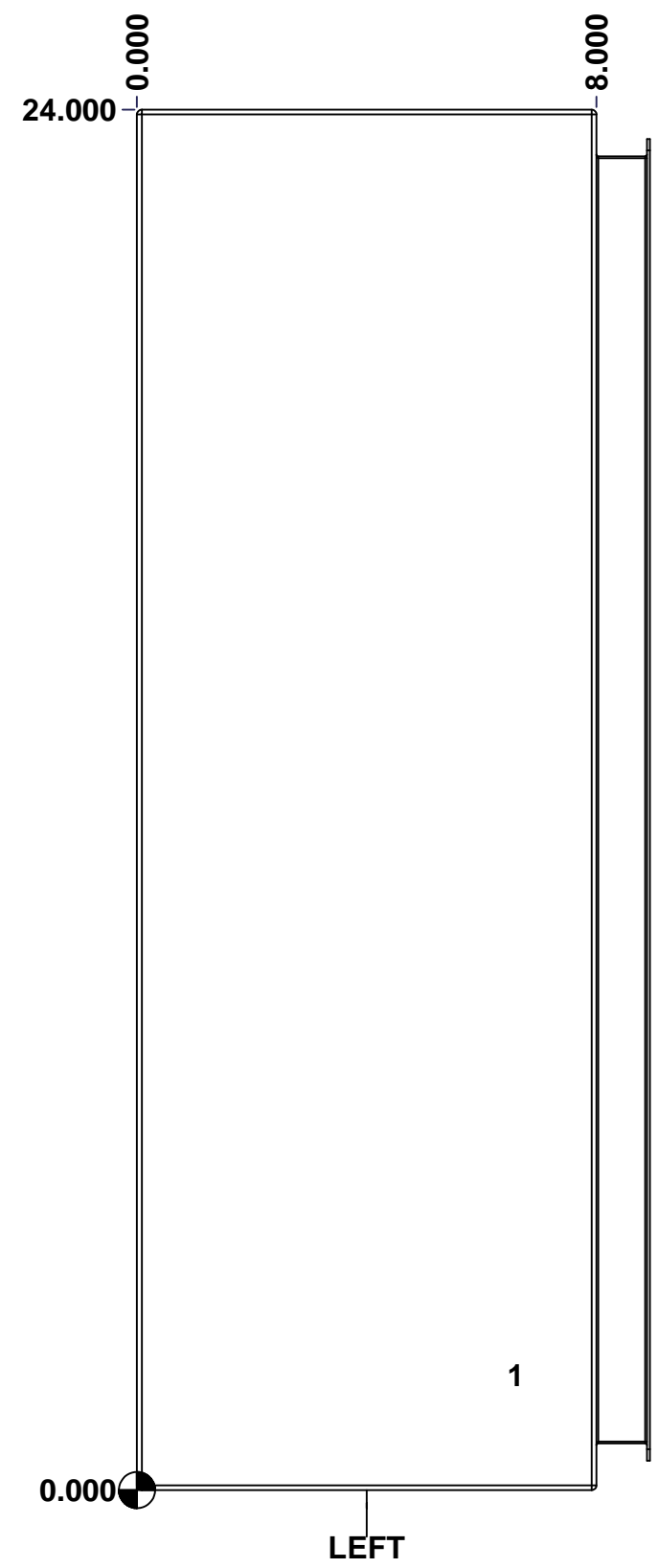

| | | | | |
|--|-------------------------------|--|----------|---|
| | Description | | Status | |
| | 5412ESSQT 24" x 12" x 8" Body | | | |
| | Part Number Numéro Pièce | | Rev. | 5 |
| | 5412ESSQT241208B | | 0 | 7 |

This drawing is confidential and must not be reproduced or used without the consent of EXM

Ce dessin est confidentiel et ne doit pas être reproduit ou utilisé sans le consentement de EXM

STANDARD FEATURES ARE NOT LISTED IN THIS HOLE TABLE

HOLE TABLE - BACK VIEW (CUSTOM FEATURE ONLY)

| CUT-OUT | XDIM | YDIM | DESCRIPTION |
|---------|--------|--------|----------------------------|
| 1 | 1.875 | 1.875 | IP STUD M8 x 35mm (Inside) |
| 2 | 1.875 | 22.125 | IP STUD M8 x 35mm (Inside) |
| 3 | 10.125 | 22.125 | IP STUD M8 x 35mm (Inside) |
| 4 | 10.125 | 1.875 | IP STUD M8 x 35mm (Inside) |
| ----- | | | |
| 5 | 11.250 | 0.750 | RND Ø0.390 |
| 6 | 11.250 | 23.250 | RND Ø0.390 |
| 7 | 0.750 | 23.250 | RND Ø0.390 |
| 8 | 0.750 | 0.750 | RND Ø0.390 |

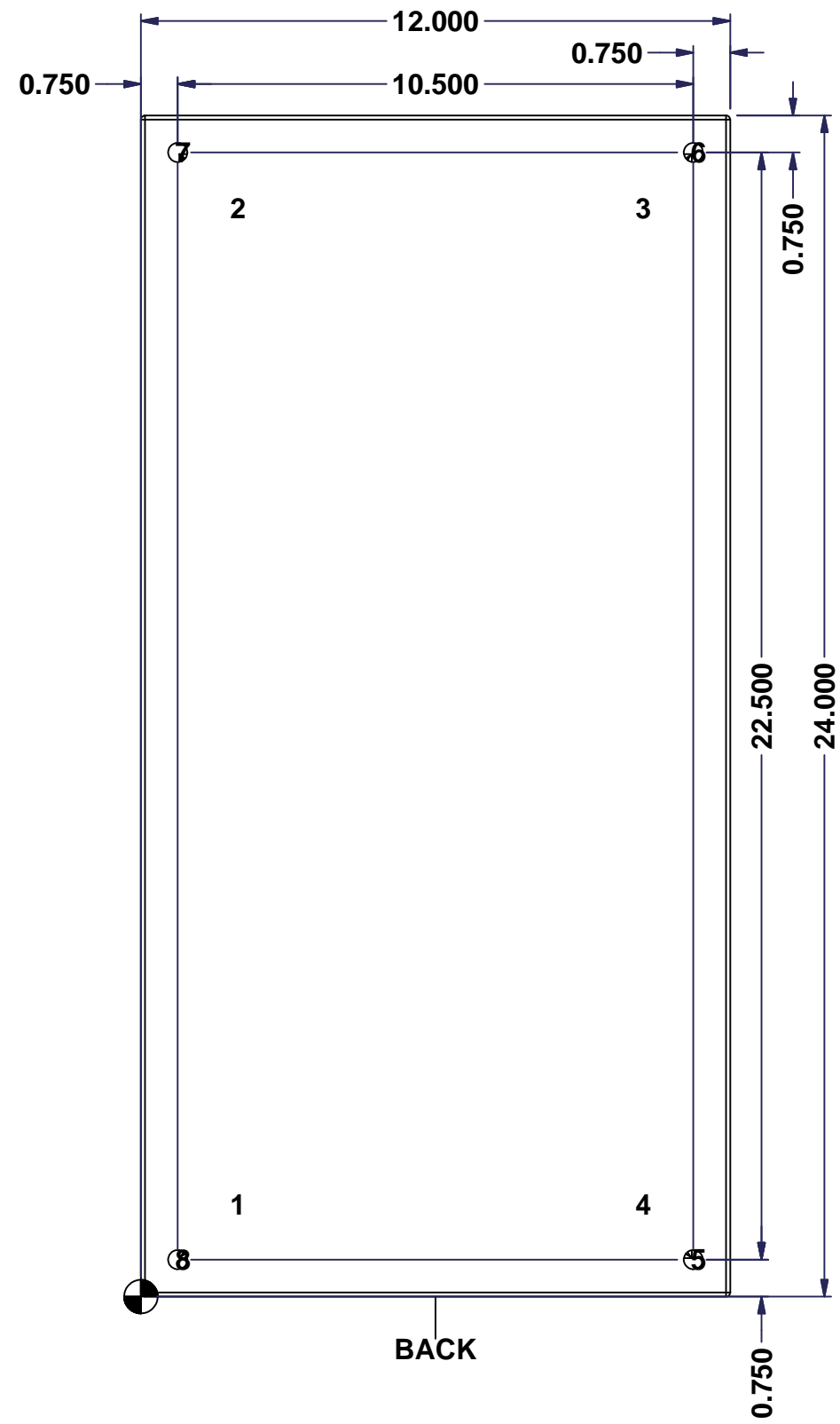

BACK

| | | | | |
|--|-------------------------------|--|--------|---|
| | Description | | Status | |
| | 5412ESSQT 24" x 12" x 8" Body | | | |
| | Part Number Numéro Pièce | | Rev. | 6 |
| | 5412ESSQT241208B | | 0 | 7 |

This drawing is confidential and must not be reproduced or used without the consent of EXM

Ce dessin est confidentiel et ne doit pas être reproduit ou utilisé sans le consentement de EXM

| No. | Revisions | Date | By/Par |
|-----|-----------|------|--------|
| | | | |
| | | | |
| | | | |
| | | | |
| | | | |

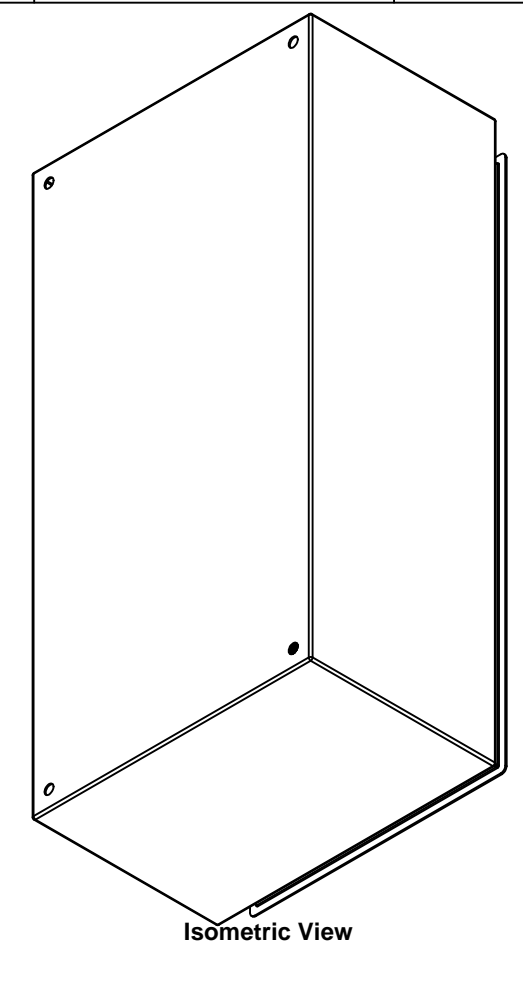

Isometric View

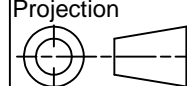

| | | |
|--|-----------------------------------|---|
|  Tél: (450) 979-4373 Fax: (450) 979-4626 www.exmweb.com | | Flatness Aplatissement Max 3.0mm Projection  |
| Customer Client | Date | |
| Drawn By Dessiné Par | BoxCad: BoxCad | Date 19-May-14 |
| Material Matière | 16 Ga Stainless Steel 304 (1.4mm) | |
| Color Couleur | Unpainted | Finish Fini Brushed |
| Description | Detail Rev. | |
| 5412ESSQT 24" x 12" x 8" Body | | Rev. 7 |
| Part Number Numéro Pièce | Rev. 0 | 7 |
| 5412ESSQT241208B | | |

| Qty | Part Number | Rev | Description |
|------------|--------------------|-----|---------------------------------------|
| 1 | STK-Q-16085 | 0 | Ground Stud M6 x 16mm Stainless Steel |
| 4 | STK-Q-16020 | 1 | Stud M8 x 35mm Stainless Steel |
| 1 | 5412ESSQT241208B-P | 0 | 5412ESSQT 24" x 12" x 8" Body Part |
| Parts List | | | |

This drawing is confidential and must not be reproduced or used without the consent of EXM

Ce dessin est confidentiel et ne doit pas être reproduit ou utilisé sans le consentement de EXM

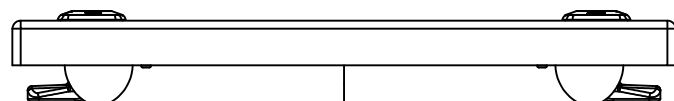

TOP

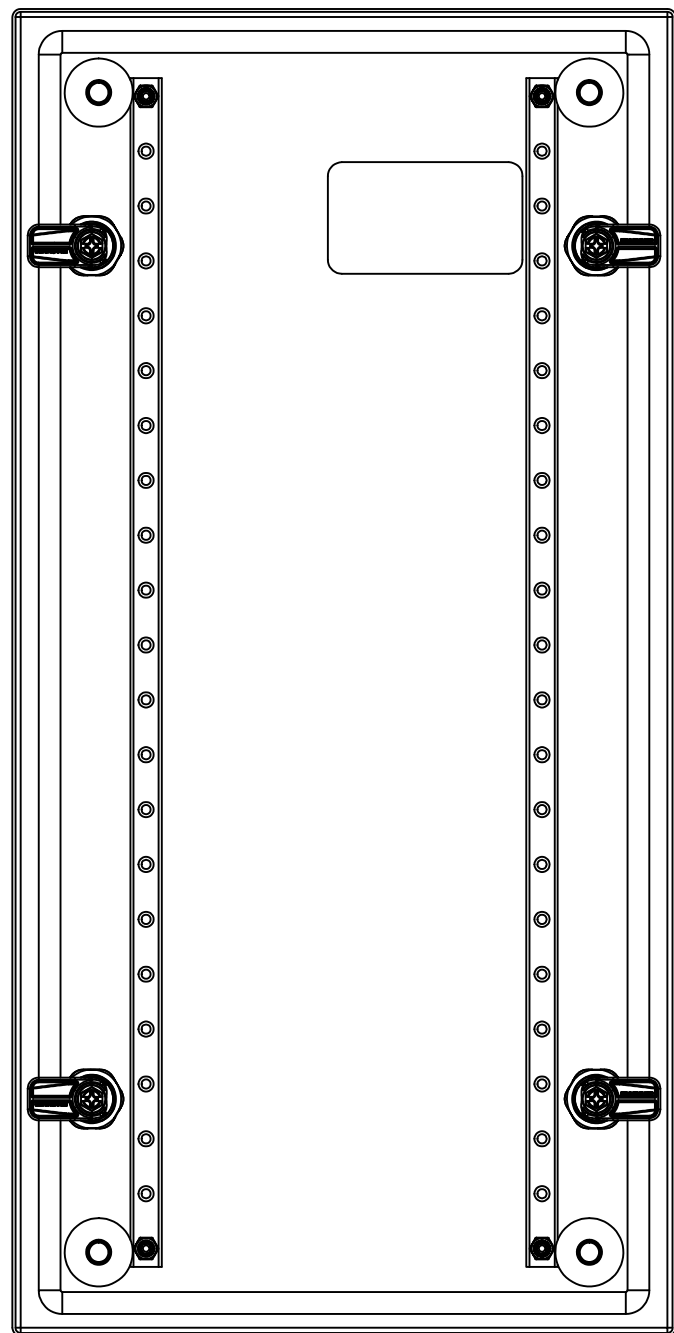

BACK

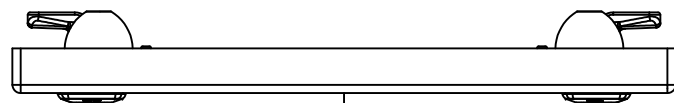

BOTTOM

0.000
0.800

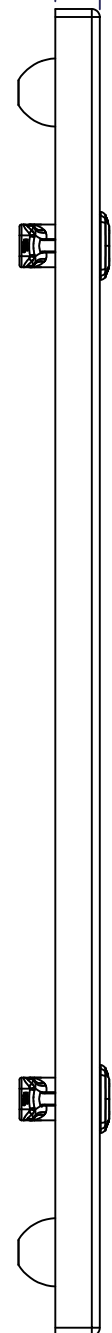

LEFT

0.000

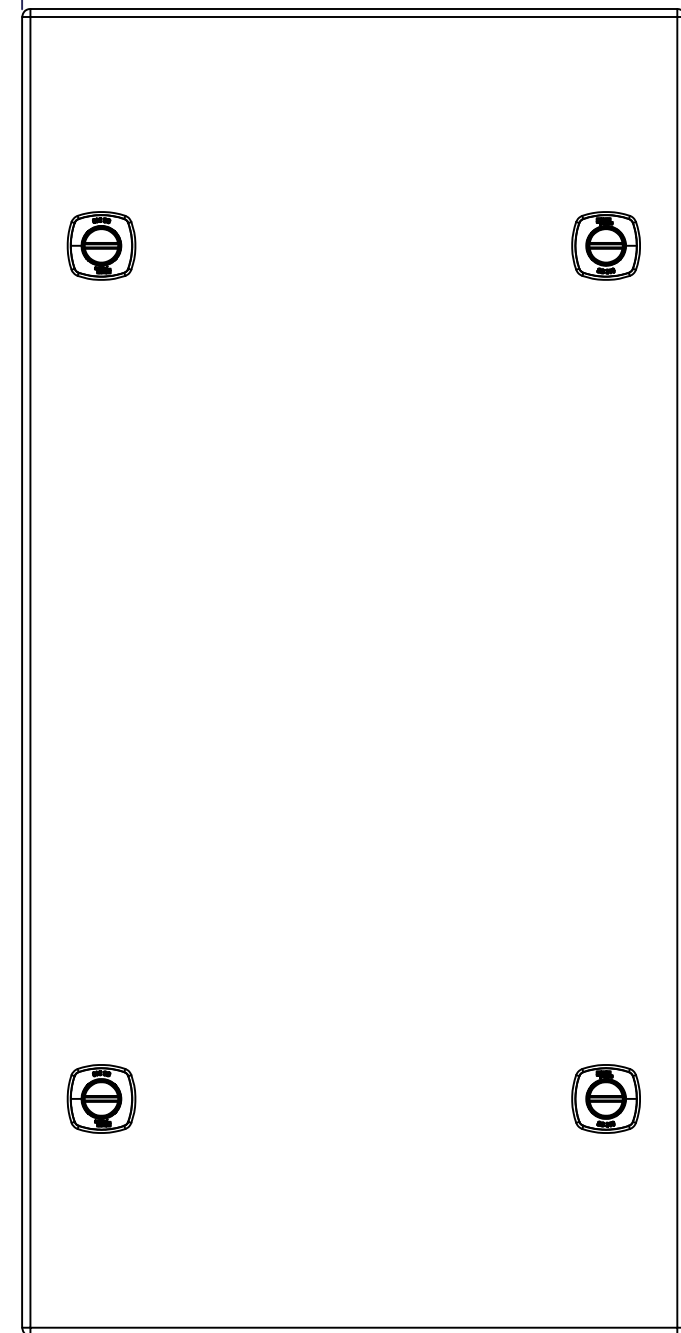

FRONT

11.918

23.803

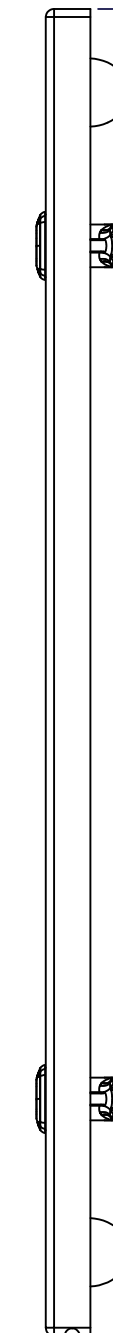

RIGHT

0.000

| No. | Revisions | Date | By/Par |
|-----|-----------|------|--------|
| | | | |
| | | | |
| | | | |
| | | | |
| | | | |

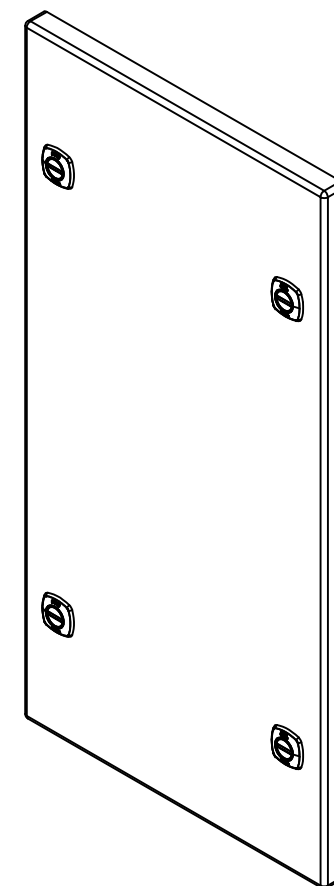

Isometric View



Tél: (450) 979-4373
Fax: (450) 979-4626
www.exmweb.com

Flatness
Aplatissement

Max 3.0mm

Projection

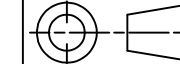

| | |
|---|------------------------|
| Customer Client | Date |
| Drawn By Dessiné Par BoxCad: BoxCad | Date 19-May-14 |
| Material Matière 16 Ga Stainless Steel 304 (1.4mm) | |
| Color Couleur Unpainted | Finish Fini Brushed |

| | |
|--|-------------|
| Description 5412ESSQT 24" x 12" Cover | Detail Rev. |
|--|-------------|

| | | |
|--|--------|--------|
| Part Number Numéro Pièce 5412ESSQT241208C | Rev. 0 | 1 3 |
|--|--------|--------|

SEE BILL OF MATERIAL ON LAST PAGE

This drawing is confidential and must not be reproduced or used without the consent of EXM

Ce dessin est confidentiel et ne doit pas être reproduit ou utilisé sans le consentement de EXM

STANDARD FEATURES ARE NOT LISTED IN THIS HOLE TABLE

HOLE TABLE - FRONT VIEW (CUSTOM FEATURE ONLY)

| CUT-OUT | XDIM | YDIM | DESCRIPTION |
|---------|--------|--------|------------------------------|
| 1 | 2.401 | 1.567 | STUD M6 x 18mm (Inside) |
| 2 | 2.401 | 22.236 | STUD M6 x 18mm (Inside) |
| 3 | 9.517 | 22.236 | STUD M6 x 18mm (Inside) |
| 4 | 9.517 | 1.567 | STUD M6 x 18mm (Inside) |
| 5 | 1.550 | 1.500 | STUD M6 x 18mm (Inside) |
| 6 | 10.368 | 1.500 | STUD M6 x 18mm (Inside) |
| 7 | 1.550 | 22.303 | STUD M6 x 18mm (Inside) |
| 8 | 10.368 | 22.303 | STUD M6 x 18mm (Inside) |
| ----- | | | |
| 9 | 4.500 | 20.053 | LABEL_EXM (Inside) |
| 10 | 1.424 | 19.553 | LOCK 880 SCQ4-SLSS6 @ 180.0° |
| 11 | 1.424 | 4.250 | LOCK 880 SCQ4-SLSS6 @ 180.0° |
| 12 | 10.494 | 19.553 | LOCK 880 SCQ4-SLSS6 @ 0.0° |
| 13 | 10.494 | 4.250 | LOCK 880 SCQ4-SLSS6 @ 0.0° |

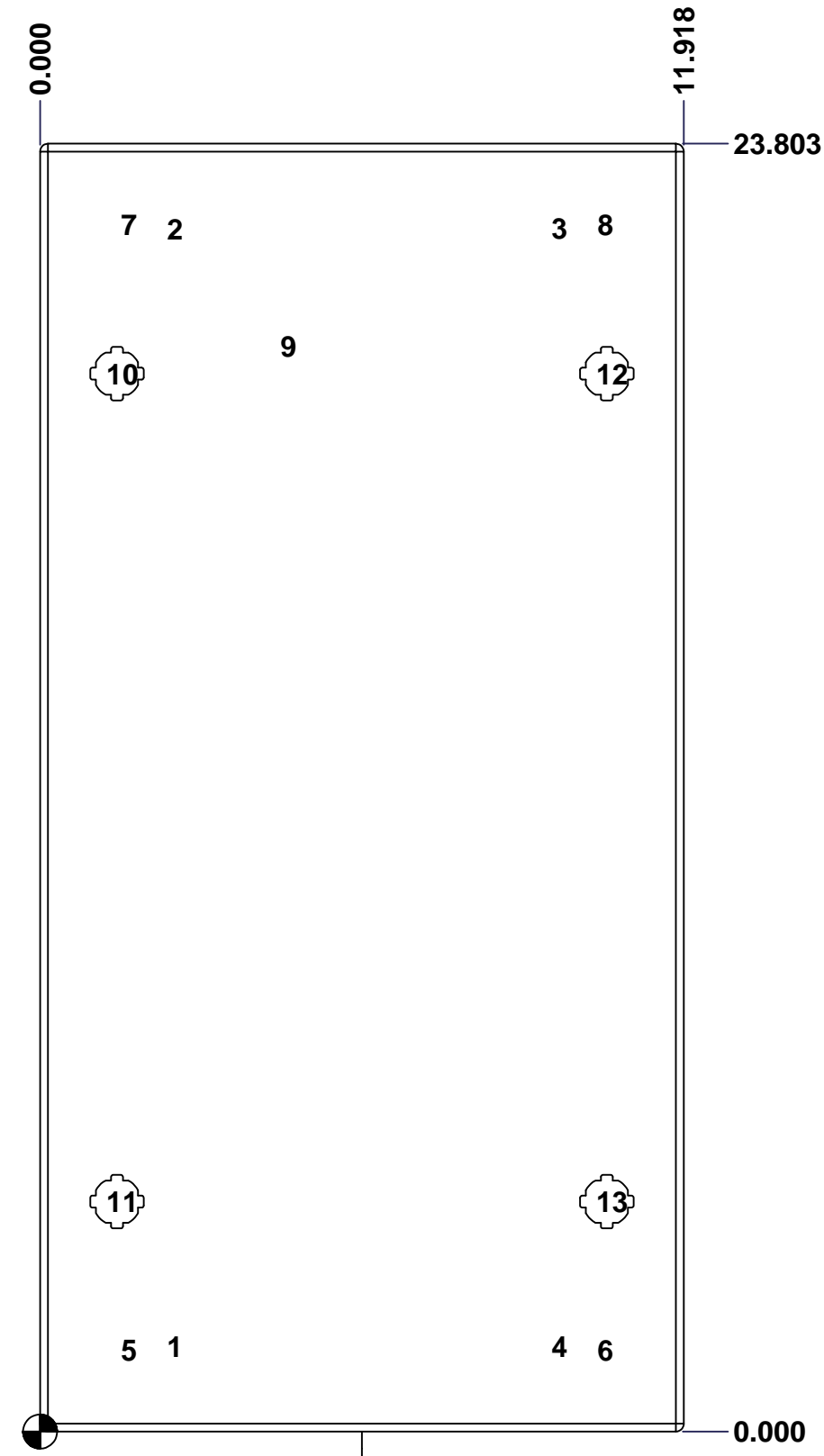

FRONT

| | | |
|--|-----------------------------|----------|
| | Description | Status |
| | 5412ESSQT 24" x 12" Cover | (NULL) |
| | Part Number Numéro Pièce | Rev. |
| | 5412ESSQT241208C | 0 |
| | | 2 |
| | | 3 |

This drawing is confidential and must not be reproduced or used without the consent of EXM

Ce dessin est confidentiel et ne doit pas être reproduit ou utilisé sans le consentement de EXM

| No. | Revisions | Date | By/Par |
|-----|-----------|------|--------|
| | | | |
| | | | |
| | | | |
| | | | |
| | | | |

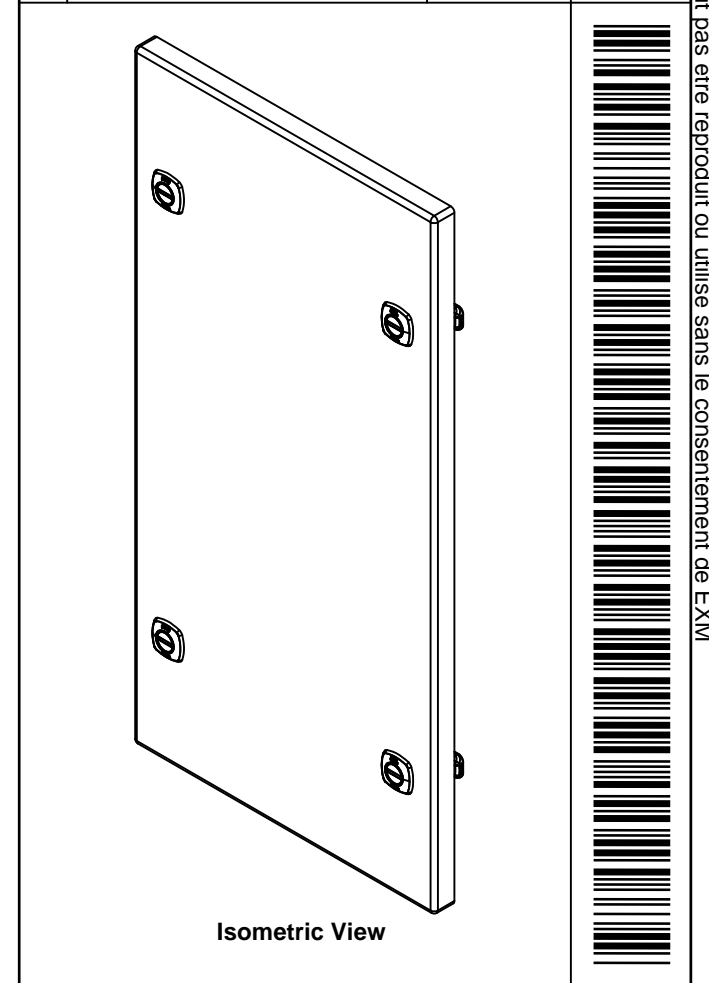

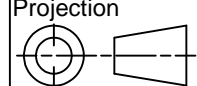
| | | |
|--|-----------------------------------|---|
|  Tél: (450) 979-4373 Fax: (450) 979-4626 www.exmweb.com | | Flatness Aplatissement Max 3.0mm Projection  |
| Customer Client | Date | |
| Drawn By Dessiné Par | BoxCad: BoxCad | Date 19-May-14 |
| Material Matière | 16 Ga Stainless Steel 304 (1.4mm) | |
| Color Couleur | Unpainted | Finish Fini Brushed |
| Description | | Detail Rev. |
| 5412ESSQT 24" x 12" Cover | | |
| Part Number Numéro Pièce | Rev. | 3 |
| 5412ESSQT241208C | 0 | 3 |

| Qty | Part Name | Rev | Description |
|------------|--------------------|-----|--|
| 1 | STK-S-00100 | 0 | 3.5" x 2" Silver Milar Flexcon Sticker |
| 2 | STK-Q-46020-24 | 5 | 5412 ES Vertical Door Stiffener 24" |
| 8 | STK-Q-16070 | 1 | Stud M6 x 18mm Stainless steel |
| 1 | 5412ESSQT241208G | 0 | 5412ESSQT 24" x 12" Cover Gasket Part |
| 1 | 5412ESSQT241208C-P | 0 | 5412ESSQT 24" x 12" Cover Part |
| 4 | 880 SCQ4-SLSS6 | 7 | 5412 ESS 1/4 Turn Lock |
| 4 | STK-Q-07220 | 1 | M6 Nylon Insert Lock Nut |
| 4 | STK-Q-46515 | 3 | 5412 ES Door Support with Brass Insert |
| Parts List | | | |

This drawing is confidential and must not be reproduced or used without the consent of EXM

Ce dessin est confidentiel et ne doit pas être reproduit ou utilisé sans le consentement de EXM

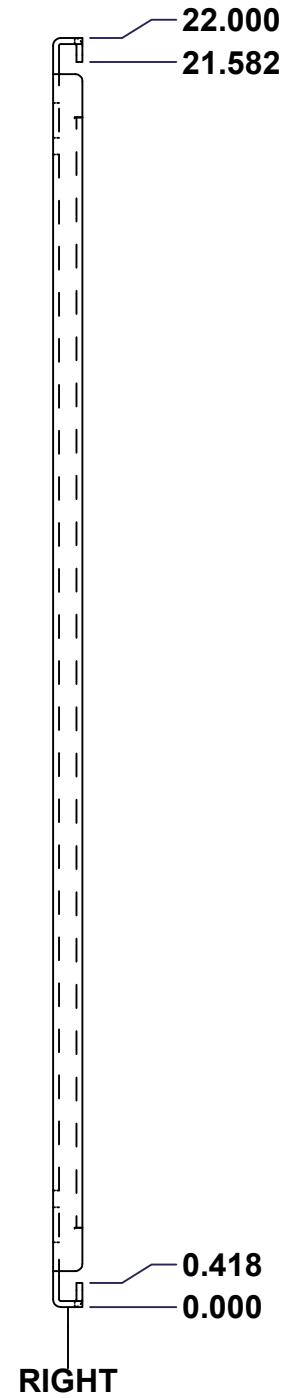
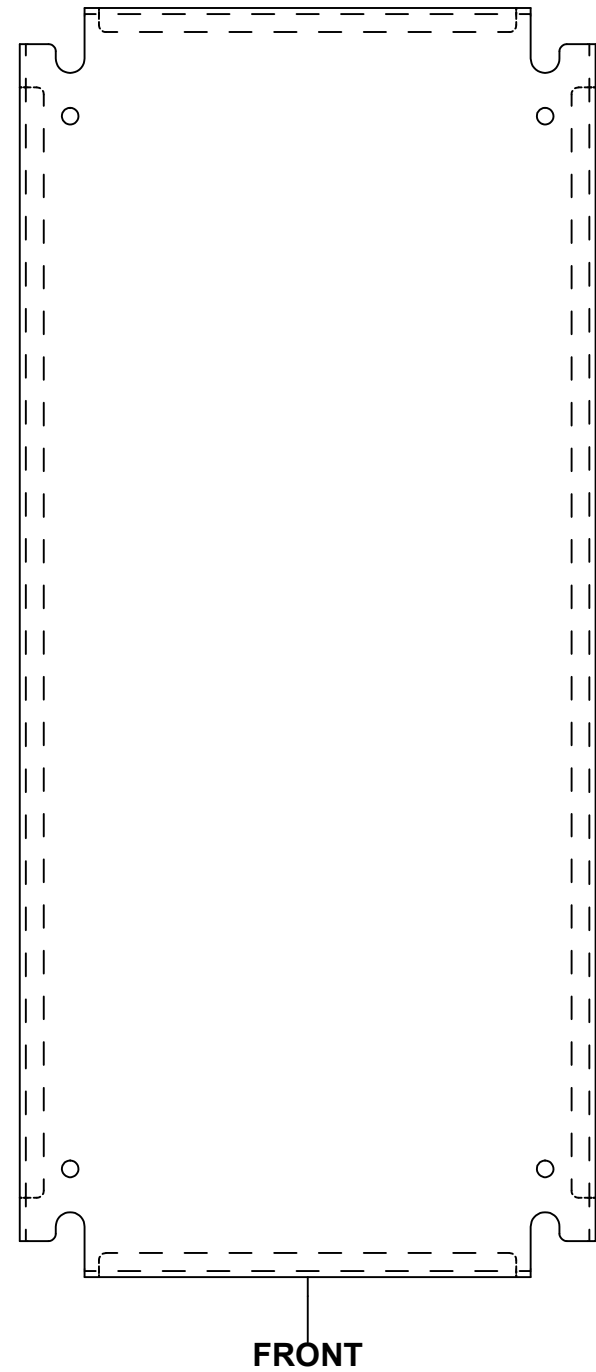
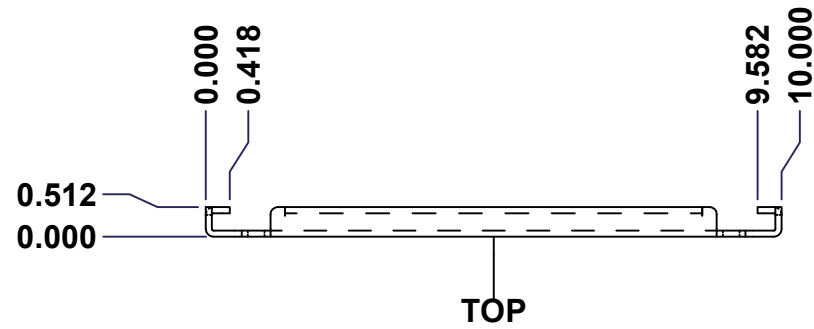

| No. | Revisions | Date | By/Par |
|-----|-----------|------|--------|
| | | | |
| | | | |
| | | | |
| | | | |
| | | | |

Isometric View

| | | |
|--|---------------|--|
| Tél: (450) 979-4373 Fax: (450) 979-4626 www.exmweb.com | | Flatness Aplatissement Max 3.0mm Projection |
| Customer Client | Date | |
| Drawn By Dessiné Par | BoxCad | Date 1/23/2007 |
| Material Matière | See Part List | |
| Color Couleur | See Part List | Finish Fini See Part List |
| Description | | Detail Rev. |
| 881 SP - Inner Panel | | |
| Part Number Numéro Pièce | Rev. 0 | 1/2 |
| 881 SP2412G | | |

| Qty | Part Number | Rev | Description | Material | Color | Finish |
|------------|---------------|-----|---------------------------|------------------|-----------|------------|
| 1 | 881 SP2412G-P | 0 | 881 SP - Inner Panel Part | 12 Ga Galvanized | Unpainted | Galvanized |
| Parts List | | | | | | |

This drawing is confidential and must not be reproduced or used without the consent of EXM

Ce dessin est confidentiel et ne doit pas être reproduit ou utilisé sans le consentement de EXM

| Table 1 | | | FRONT VIEW |
|---------|-------|--------|--------------------------|
| CUT-OUT | XDIM | YDIM | DESCRIPTION |
| 1 | 0.875 | 1.875 | GROUND HOLE (RND Ø0.290) |
| 2 | 9.125 | 1.875 | GROUND HOLE (RND Ø0.290) |
| 3 | 0.875 | 20.125 | GROUND HOLE (RND Ø0.290) |
| 4 | 9.125 | 20.125 | GROUND HOLE (RND Ø0.290) |

All knockouts are actual size / Les disques défonçables sont grandeur réel

| No. | Revisions | Date | By/Par |
|-----|-----------|------|--------|
| | | | |
| | | | |
| | | | |
| | | | |
| | | | |

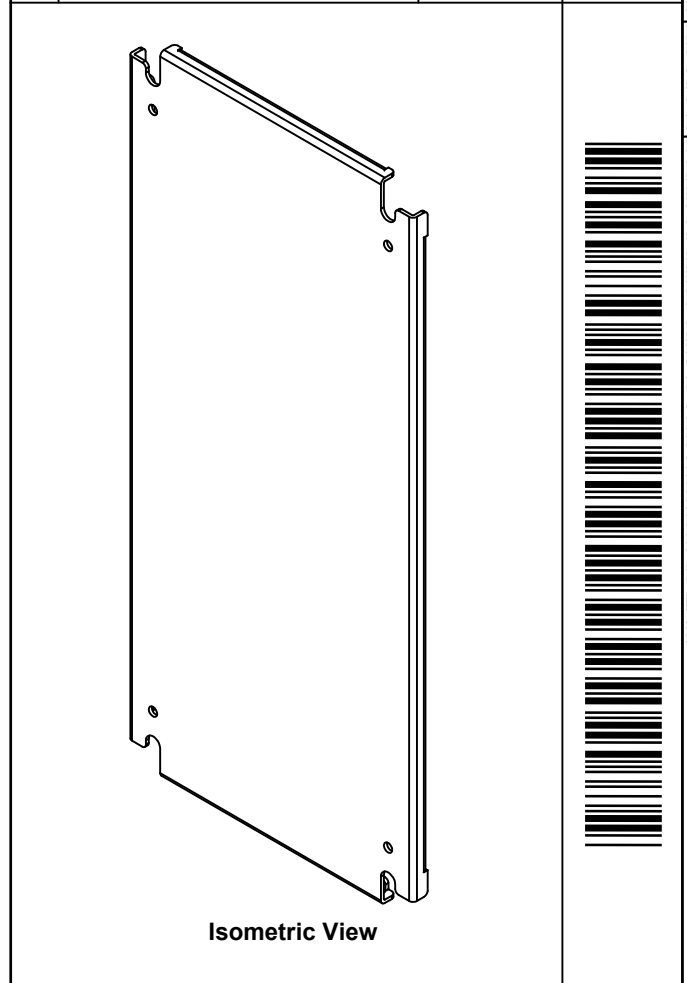
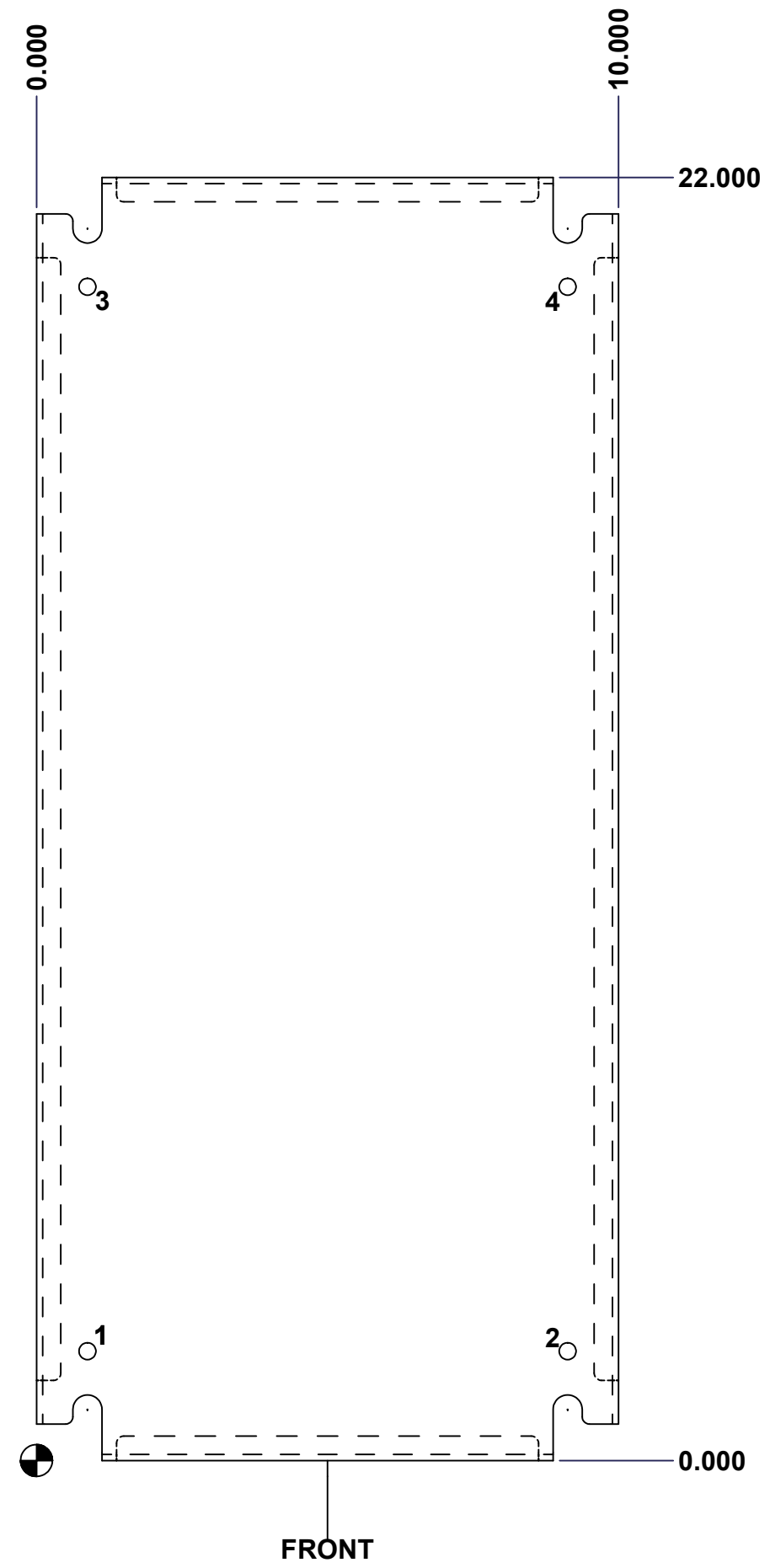

| | | | | | |
|---|--|--|--|--|--|
| | | Tél: (450) 979-4373 Fax: (450) 979-4626 www.exmweb.com | | Flatness Aplatissement Max 3.0mm | |
| Customer Client | | Date | | Projection | |
| Drawn By Dessiné Par BoxCad | | Date 1/23/2007 | | Material Matière See Part List | |
| Color Couleur See Part List | | Finish Fini See Part List | | Description 881 SP - Inner Panel | |
| Part Number Numéro Pièce 881 SP2412G | | Rev. 0 | | Detail Rev. 2 | |