

This drawing is confidential and must not be reproduced or used without the consent of EXM

Ce dessin est confidentiel et ne doit pas être reproduit ou utilisé sans le consentement de EXM

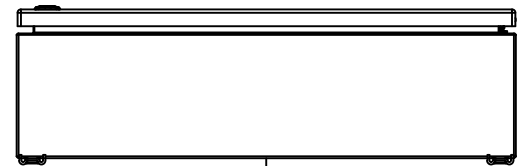

TOP

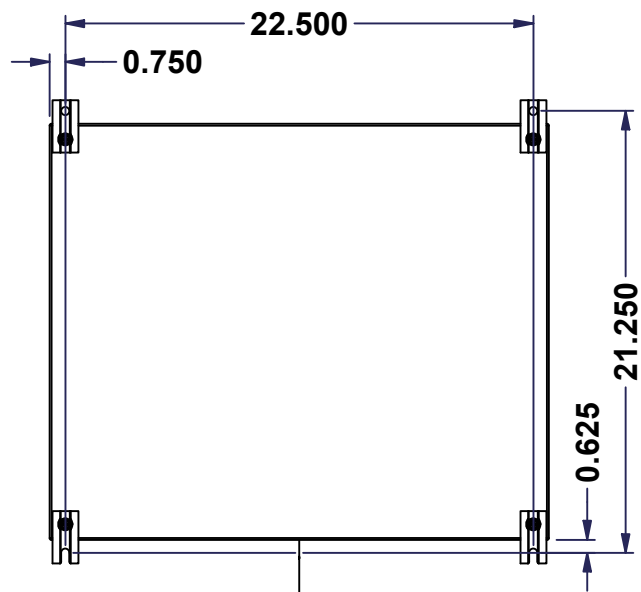

BACK

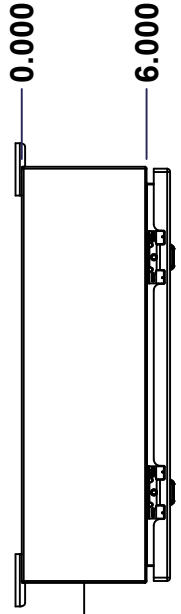

LEFT

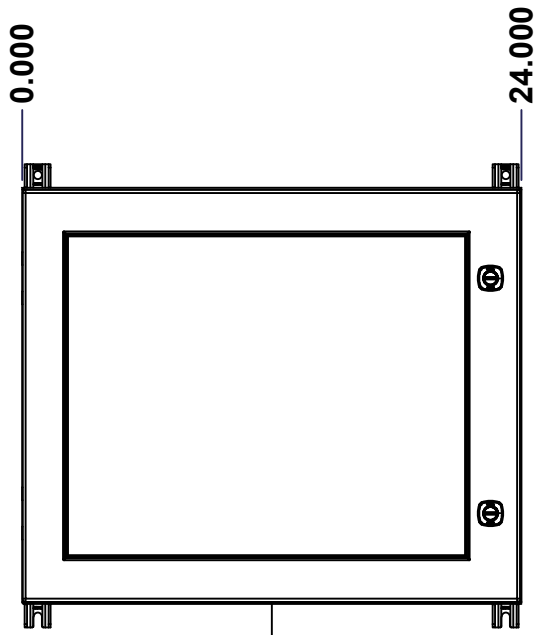

FRONT

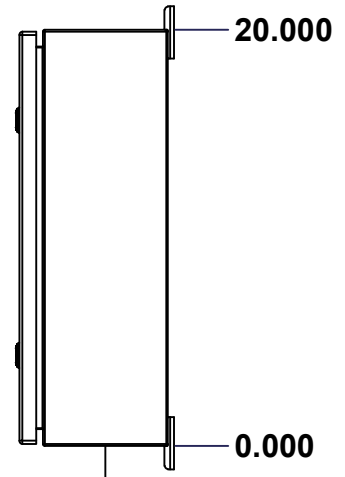

RIGHT

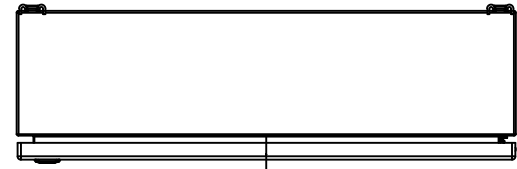

BOTTOM

No.	Revisions	Date	By/Par

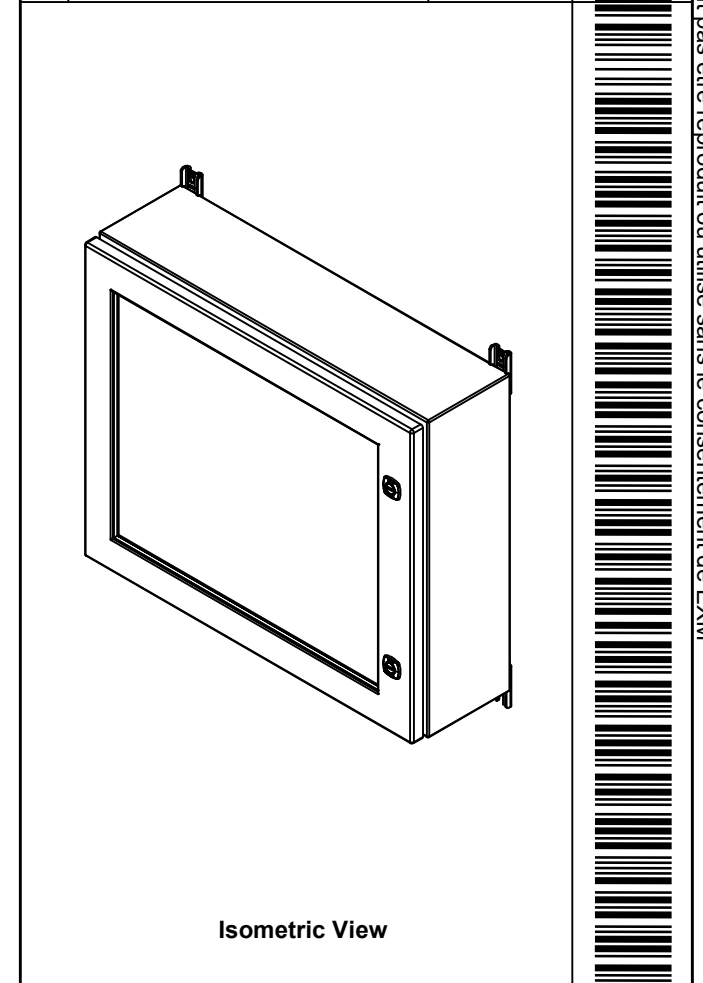

Isometric View



**GRAIN DIRECTION:
TOP/BOTTOM: HORIZONTAL
LEFT/RIGHT/BACK/FRONT: VERTICAL**

Tél: (450) 979-4373 Fax: (450) 979-4626 www.exmweb.com		Flatness Aplatissement Max 3.0mm Projection
Customer Client	Date	
Drawn By Dessiné Par	BoxCad: BoxCad	Date 20-Jun-23
Material Matière	16 Ga Stainless Steel 316 (1.4mm)	
Color Couleur	Unpainted	Finish Fini Brushed
Description	Detail Rev.	
5412ESSW 20" x 24" x 6" Assembly		
Part Number Numéro Pièce	Rev. 0	1 15

SEE BILL OF MATERIAL ON LAST PAGE 5412ESSW2024066THNOIP

This drawing is confidential and must not be reproduced or used without the consent of EXM

Ce dessin est confidentiel et ne doit pas être reproduit ou utilisé sans le consentement de EXM

NOTE	
ITEM	DESCRIPTION
1	NEMA 4X Enclosure
2	C/W Standard ground studs on box and cover
3	W/O Standard door stiffener
4	W/O Inner panel
5	C/W Standard inner panel mounting studs
6	C/W 885 ESMF4_OPEN Sold separately (Installed)
7	C/W 885 ESMF4_CLOSE Sold separately (Installed)
8	C/W R5 Insulation (Installed by EXM)

No.	Revisions	Date	By/Par

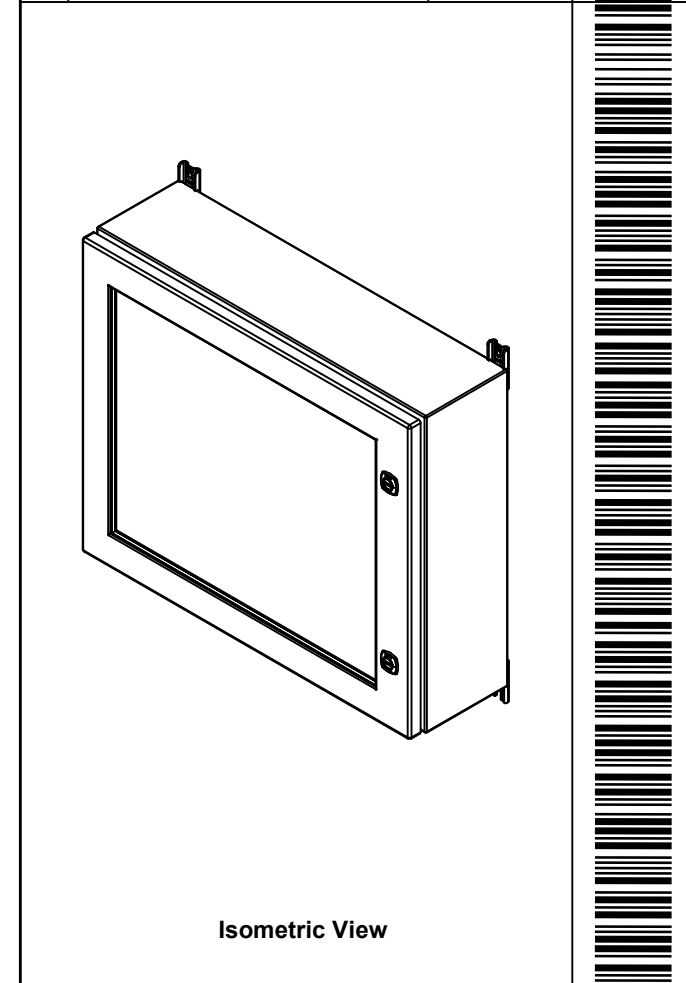

Tél: (450) 979-4373
Fax: (450) 979-4626
www.exmweb.com

Flatness
Aplatissement
Max 3.0mm

Projection

Customer Client	Date
Drawn By Dessiné Par BoxCad: BoxCad	Date 20-Jun-23

Material Matière 16 Ga Stainless Steel 316 (1.4mm)

Color Couleur Unpainted	Finish Fini Brushed
-------------------------	---------------------

Description 5412ESSW 20" x 24" x 6" Assembly

Part Number Numéro Pièce	Rev. 0	2
5412ESSW2024066THNOIP		15

Qty	Part Number	Rev	Description
4	STK-Q-00600	2	M12 to M8 Adaptor
1	STK-K-01800	5	5412 ES Accessory Kit
1	5412ESSW2024066THNO IPC	0	5412ESSW 20" x 24" Cover
1	5412ESSW2024066THNO IPB	0	5412ESSW 20" x 24" x 6" Body
2	STK-Q-04051-08	1	M6 x 8mm Stainless Steel Hexagon Socket Head Machine Screw with Nyseal

Parts List

PACKING		
ITEM	QTY	DESCRIPTION
Cardboard sleeve	2	Top and Bottom
Cardboard strip	2	Between back of enclosure and inner panel
Plastic bag	1	To protect cover surface and inside gasket
Plastic strap - Black	2	To Squeeze the 2 cardboard sleeve together
Packaging label	1	White label with product number

This drawing is confidential and must not be reproduced or used without the consent of EXM

Ce dessin est confidentiel et ne doit pas être reproduit ou utilisé sans le consentement de EXM

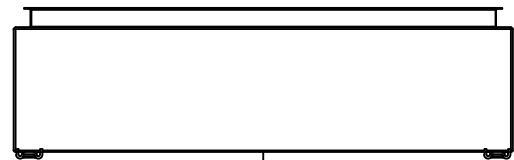

TOP

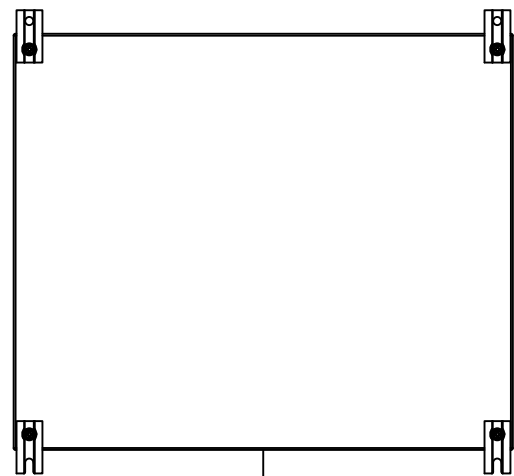

BACK

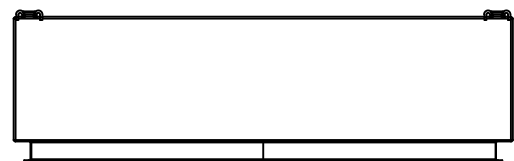

BOTTOM

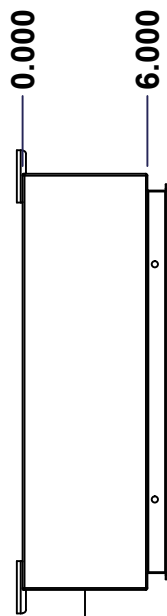

LEFT

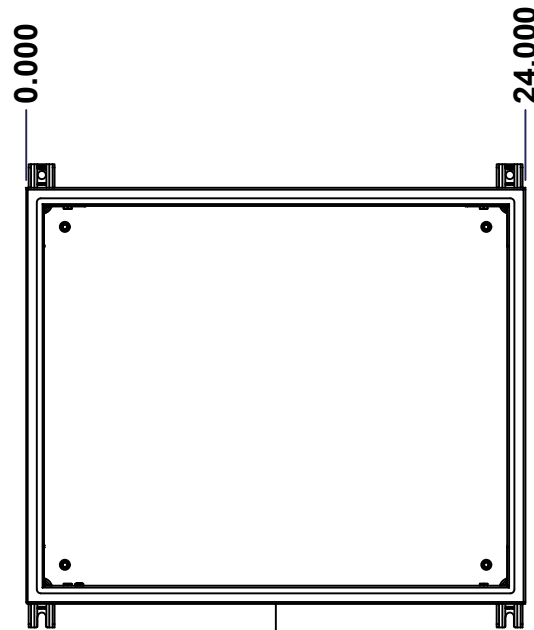

FRONT

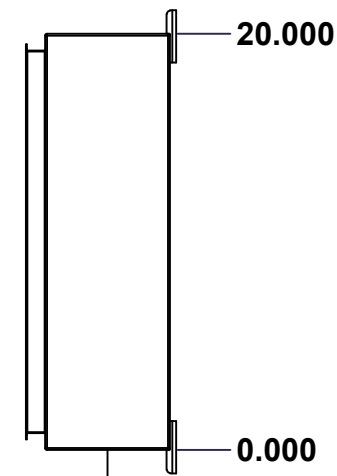

RIGHT

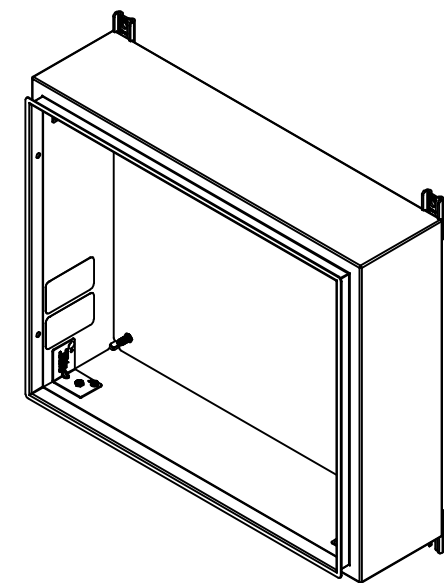

Isometric View

No.	Revisions	Date	By/Par

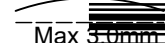
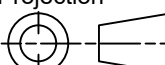

 Tél: (450) 979-4373 Fax: (450) 979-4626 www.exmweb.com		Flatness Aplatissement  Max 5.0mm Projection 
Customer Client	Date	
Drawn By Dessiné Par	BoxCad: BoxCad	Date 20-Jun-23
Material Matière	16 Ga Stainless Steel 316 (1.4mm)	
Color Couleur	Unpainted	Finish Fini Brushed
Description	Detail Rev.	
5412ESSW 20" x 24" x 6" Body		
Part Number Numéro Pièce	Rev.	3
SEE BILL OF MATERIAL ON LAST PAGE 5412ESSW2024066THNOIPB 0		15

This drawing is confidential and must not be reproduced or used without the consent of EXM

Ce dessin est confidentiel et ne doit pas être reproduit ou utilisé sans le consentement de EXM

STANDARD FEATURES ARE NOT LISTED IN THIS HOLE TABLE			
HOLE TABLE - TOP VIEW (CUSTOM FEATURE ONLY)			
CUT-OUT	XDIM	YDIM	DESCRIPTION
1	2.000	4.500	INSUL. STUD M6 x 18mm (Inside)
2	22.000	4.500	INSUL. STUD M6 x 18mm (Inside)

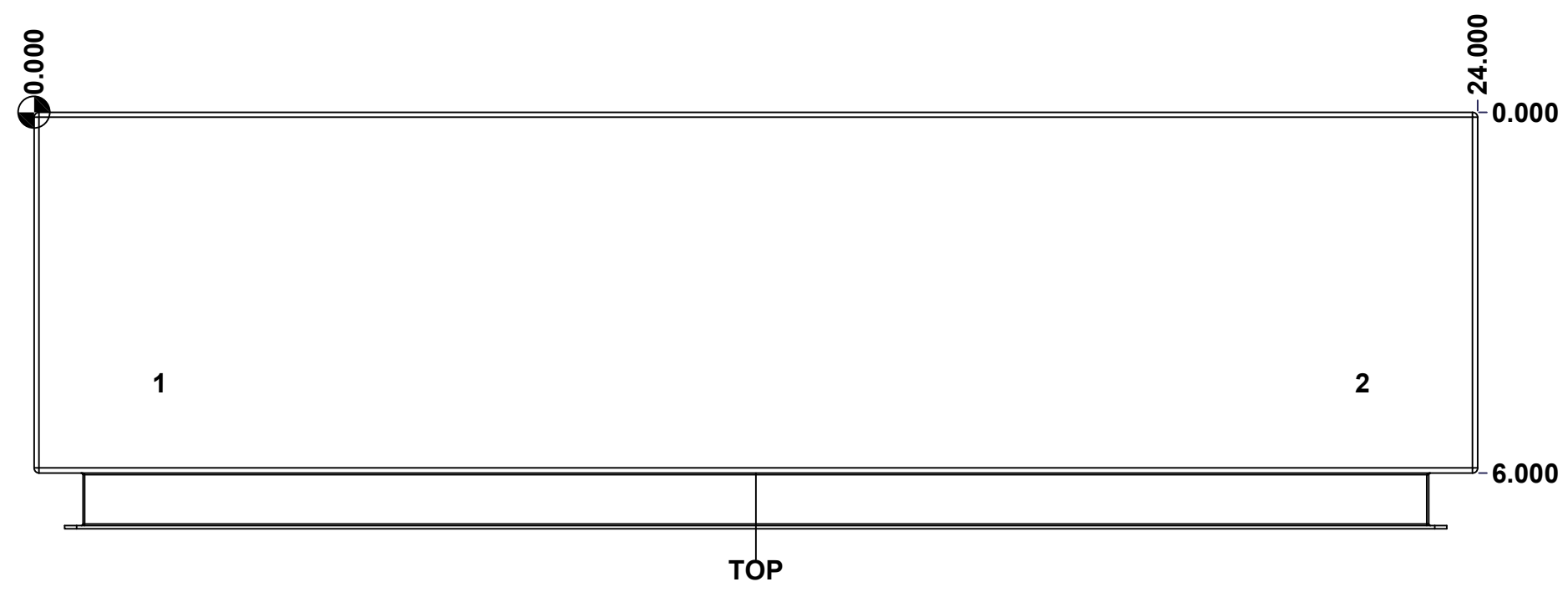

	Description	Status
	5412ESSW 20" x 24" x 6" Body	(NULL)
	Part Number Numéro Pièce	Rev.
	5412ESSW2024066THNOIPB 0	4
		15

This drawing is confidential and must not be reproduced or used without the consent of EXM

Ce dessin est confidentiel et ne doit pas être reproduit ou utilisé sans le consentement de EXM

STANDARD FEATURES ARE NOT LISTED IN THIS HOLE TABLE			
HOLE TABLE - BOTTOM VIEW (CUSTOM FEATURE ONLY)			
CUT-OUT	XDIM	YDIM	DESCRIPTION
1	2.000	4.500	INSUL. STUD M6 x 18mm (Inside)
2	22.000	4.500	INSUL. STUD M6 x 18mm (Inside)

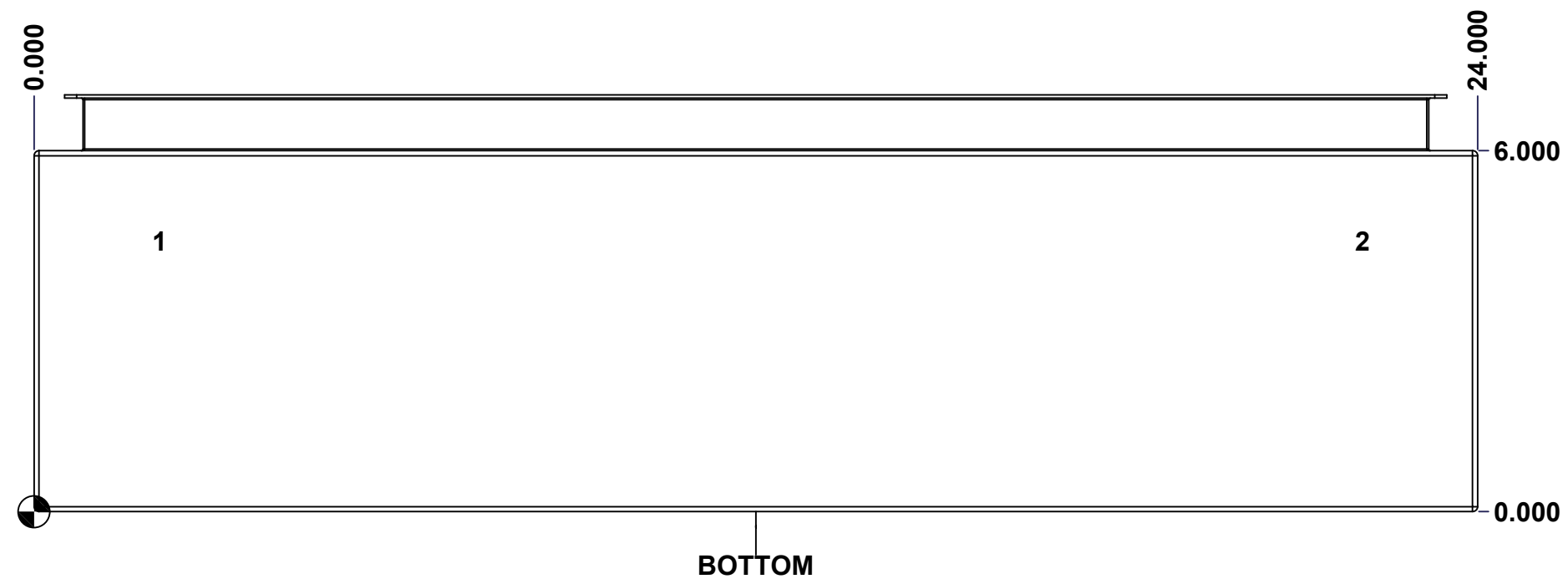

BOTTOM

	Description	Status
	5412ESSW 20" x 24" x 6" Body	(NULL)
	Part Number Numéro Pièce	Rev. 5
	5412ESSW2024066THNOIPB 0	15

This drawing is confidential and must not be reproduced or used without the consent of EXM

Ce dessin est confidentiel et ne doit pas être reproduit ou utilisé sans le consentement de EXM

STANDARD FEATURES ARE NOT LISTED IN THIS HOLE TABLE

HOLE TABLE - BACK VIEW (CUSTOM FEATURE ONLY)

CUT-OUT	XDIM	YDIM	DESCRIPTION
1	1.875	1.875	IP STUD M8 x 35mm (Inside)
2	1.875	18.125	IP STUD M8 x 35mm (Inside)
3	22.125	18.125	IP STUD M8 x 35mm (Inside)
4	22.125	1.875	IP STUD M8 x 35mm (Inside)

5	23.250	0.000	FOOT 885 ESMF4_OPEN
6	0.750	0.000	FOOT 885 ESMF4_OPEN
7	23.250	20.000	FOOT 885 ESMF4_CLOSE
8	0.750	20.000	FOOT 885 ESMF4_CLOSE

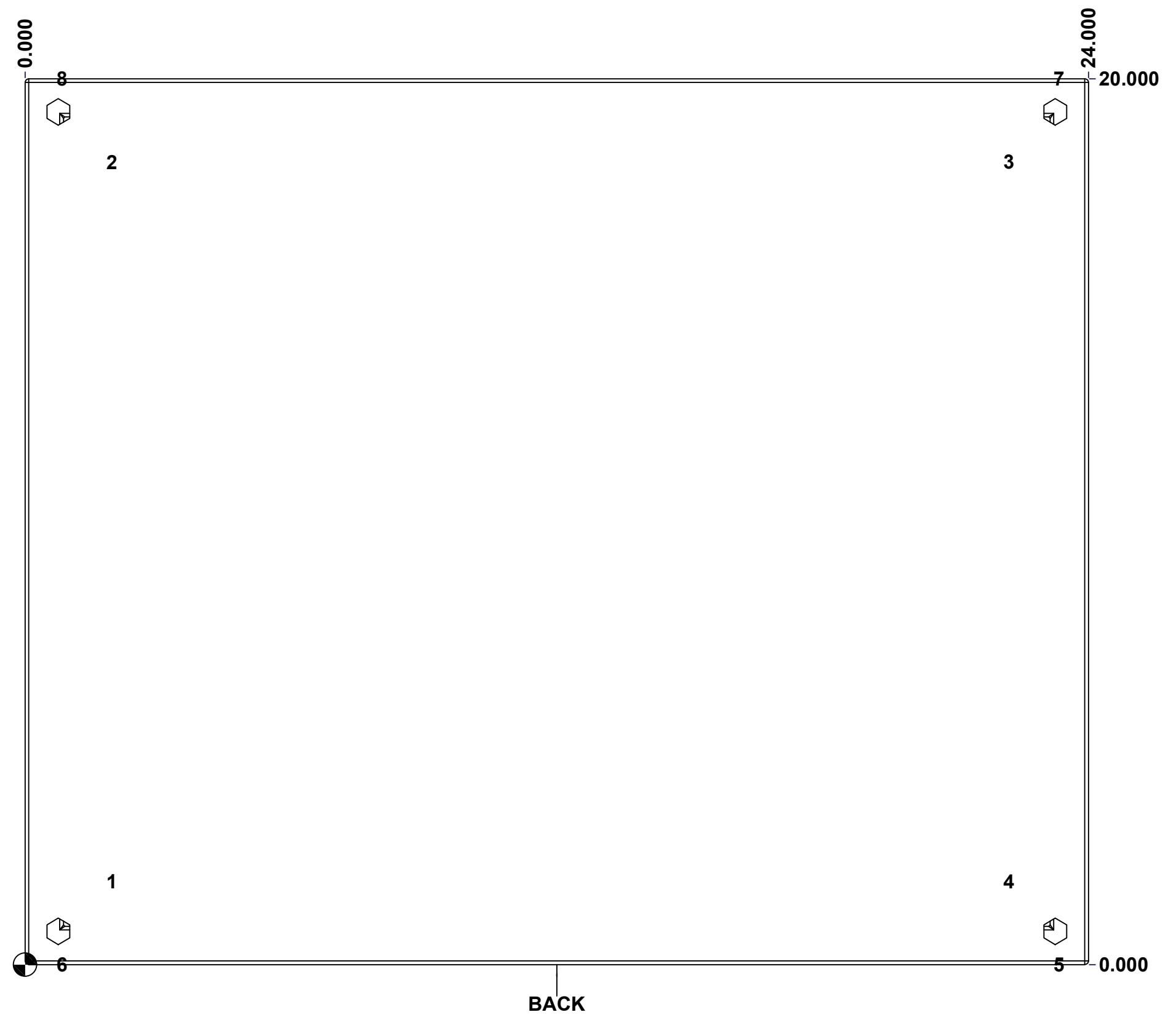

	Description	Status
	5412ESSW 20" x 24" x 6" Body	(NULL)
	Part Number Numéro Pièce	Rev.
	5412ESSW2024066THNOIPB 0	6
		15

This drawing is confidential and must not be reproduced or used without the consent of EXM

Ce dessin est confidentiel et ne doit pas être reproduit ou utilisé sans le consentement de EXM

No.	Revisions	Date	By/Par

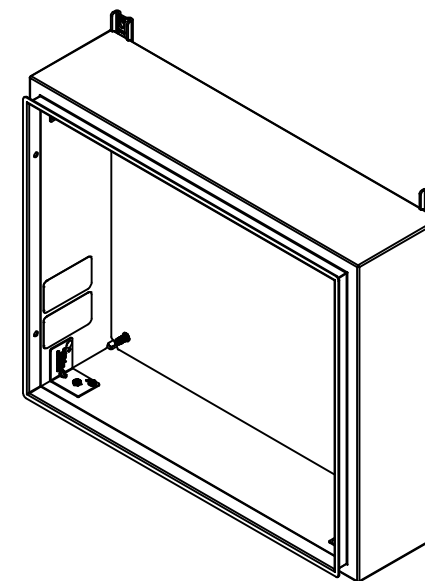

Isometric View



2	885ESMF4-FEET	0	885 ESMF4 Stainless Steel Mounting Foot
4	RIVET_NUT_SS_M10_FH_CE	0	Stainless Steel Rivet Nut M10 (Low Profile Close End)
4	STK-Q-06670	2	M10 x 16mm Stainless Steel Machine Screw
2	885ESMF4-FEET-A	0	885 ESMF4 Stainless Steel Mounting Foot (Opened Slot)
2	STK-S-00100	0	3.5" x 2" Silver Milar Flexcon Sticker
1	STK-K-70554	3	5412 ESTH Accessory Kit
1	5412ESSW2024066THNO IPI-RS	0	5412ESSW 20" x 24" Right Insulation
1	5412ESSW2024066THNO IPI-LS	0	5412ESSW 20" x 24" Left Insulation
1	5412ESSW2024066THNO IPI-BT	0	5412ESSW 20" x 24" Top and Bottom Insulation
1	5412ESSW2024066THNO IPI-TP	0	5412ESSW 20" x 24" Top and Bottom Insulation
1	5412ESSW2024066THNO IPI-B	0	5412ESSW 20" x 24" Back Insulation
4	STK-Q-16070	1	Stud M6 x 18mm Stainless steel
4	STK-Q-16020	1	Stud M8 x 35mm Stainless Steel
1	5412ESSW2024066THNO IPB-P	0	5412ESSW 20" x 24" x 6" Body Part

Qty	Part Number	Rev	Description
Parts List			

<p>Tél: (450) 979-4373 Fax: (450) 979-4626 www.exmweb.com</p>	<p>Flatness Aplatissement Max 0.0mm</p>
	<p>Projection</p>
Customer Client	Date
Drawn By Dessiné Par BoxCad: BoxCad	Date 20-Jun-23
Material Matière	16 Ga Stainless Steel 316 (1.4mm)
Color Couleur	Unpainted Finish Fini Brushed
Description	Detail Rev.
5412ESSW 20" x 24" x 6" Body	
Part Number Numéro Pièce	Rev. 7
5412ESSW2024066THNOIPB 0	15

This drawing is confidential and must not be reproduced or used without the consent of EXM

Ce dessin est confidentiel et ne doit pas être reproduit ou utilisé sans le consentement de EXM

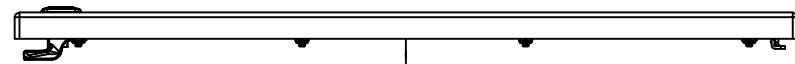

TOP

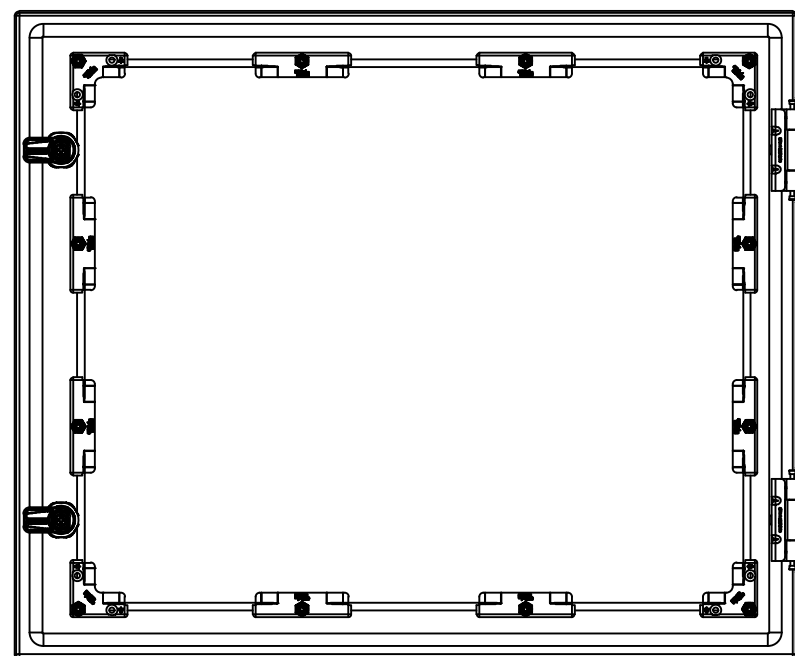

BACK

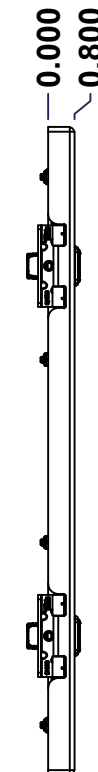

LEFT

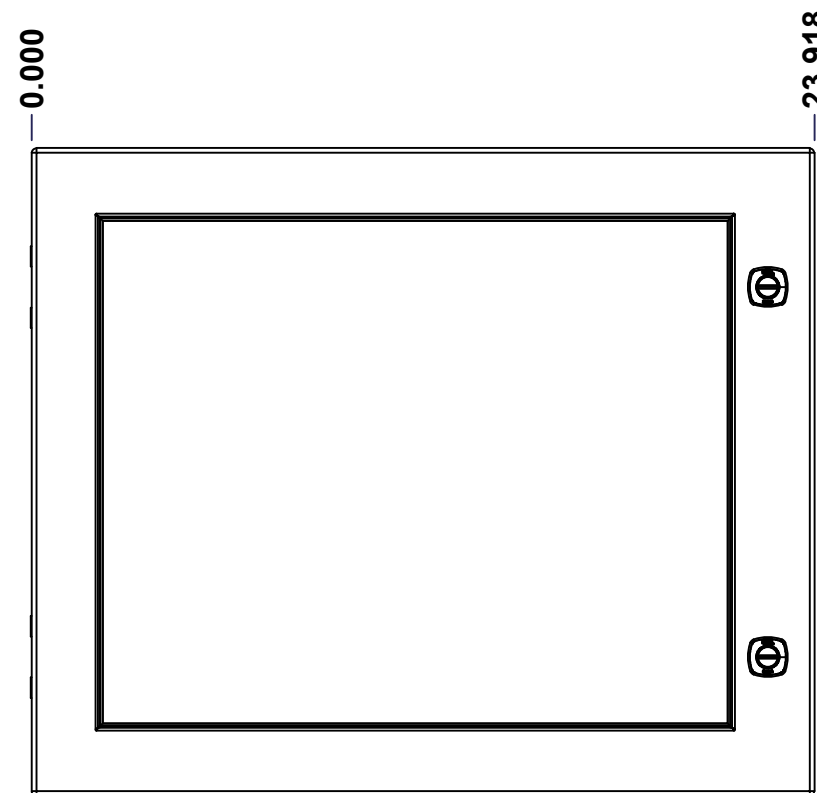

FRONT

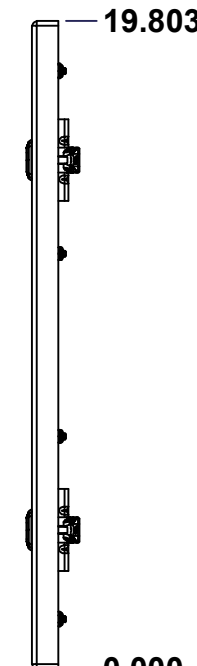

RIGHT

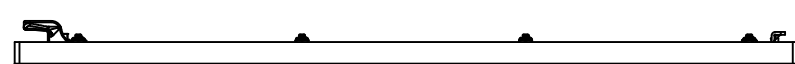

BOTTOM

No.	Revisions	Date	By/Par

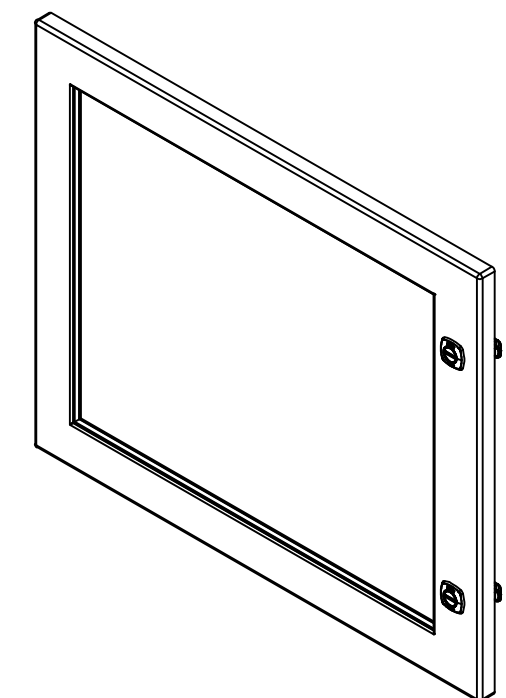

Isometric View



Tél: (450) 979-4373
 Fax: (450) 979-4626
www.exmweb.com

Flatness
Aplatissement
Max 5.0mm
Projection

Customer Client	Date
Drawn By Dessiné Par BoxCad: BoxCad	Date 20-Jun-23
Material Matière 16 Ga Stainless Steel 316 (1.4mm)	
Color Couleur Unpainted	Finish Fini Brushed
Description 5412ESSW 20" x 24" Cover	Detail Rev.
Part Number Numéro Pièce	Rev. 8

SEE BILL OF MATERIAL ON LAST PAGE 5412ESSW2024066THNOIPC 0

This drawing is confidential and must not be reproduced or used without the consent of EXM

Ce dessin est confidentiel et ne doit pas être reproduit ou utilisé sans le consentement de EXM

STANDARD FEATURES ARE NOT LISTED IN THIS HOLE TABLE

HOLE TABLE - FRONT VIEW (CUSTOM FEATURE ONLY)

CUT-OUT	XDIM	YDIM	DESCRIPTION
1	1.469	7.110	STUD M6 x 18mm (Inside)
2	21.968	7.110	STUD M6 x 18mm (Inside)
3	1.469	12.693	STUD M6 x 18mm (Inside)
4	21.968	12.693	STUD M6 x 18mm (Inside)
5	1.469	18.276	STUD M6 x 18mm (Inside)
6	1.469	1.527	STUD M6 x 18mm (Inside)
7	8.302	18.276	STUD M6 x 18mm (Inside)
8	8.302	1.527	STUD M6 x 18mm (Inside)
9	15.135	18.276	STUD M6 x 18mm (Inside)
10	15.135	1.527	STUD M6 x 18mm (Inside)
11	21.968	18.276	STUD M6 x 18mm (Inside)
12	21.968	1.527	STUD M6 x 18mm (Inside)

13	22.494	15.553	880 SCQ4-SLSS6
14	22.494	4.250	880 SCQ4-SLSS6

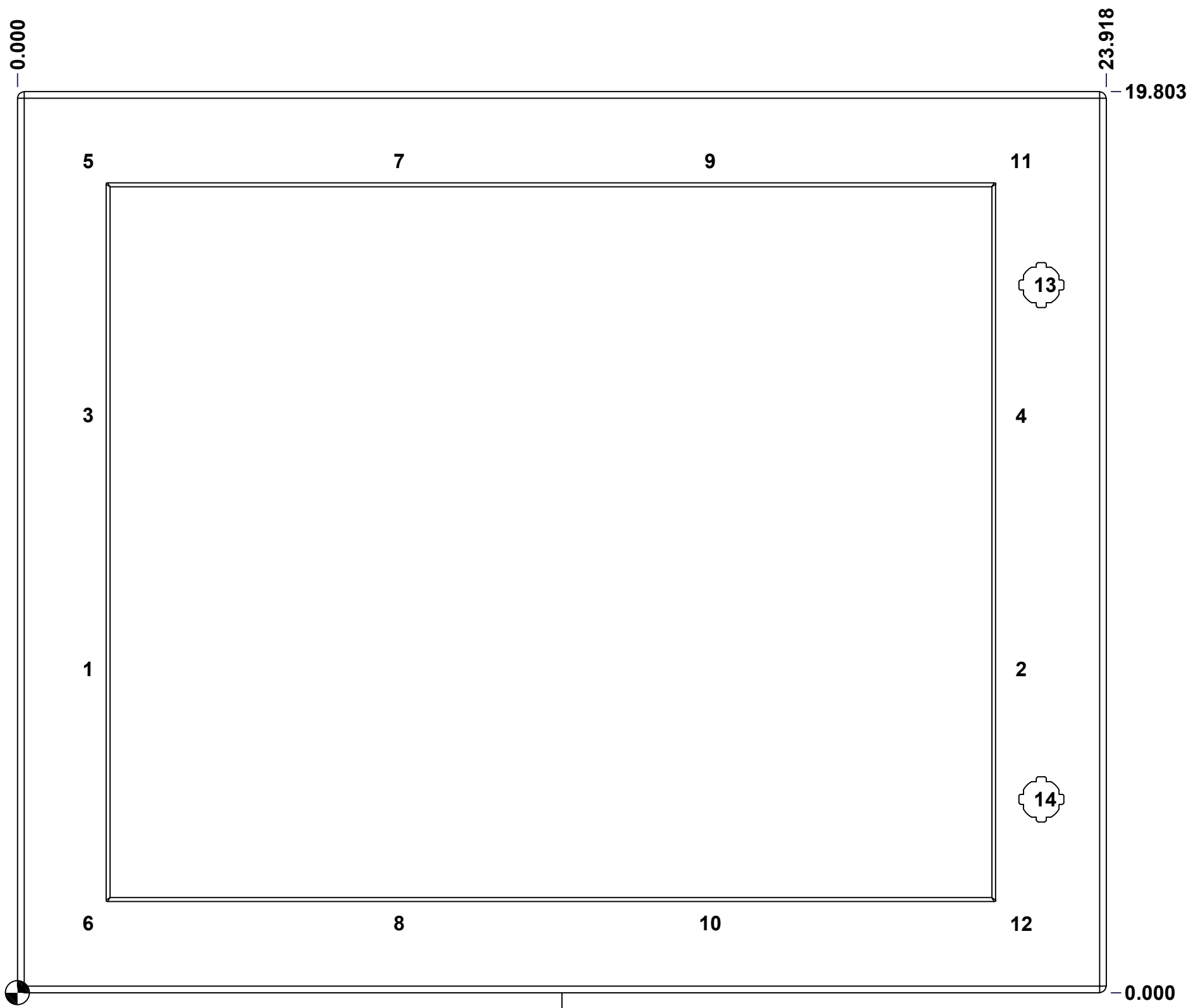

FRONT

	Description	Status
	5412ESSW 20" x 24" Cover	(NULL)
	Part Number Numéro Pièce	Rev.
	5412ESSW2024066THNOIPC 0	9
		15

This drawing is confidential and must not be reproduced or used without the consent of EXM

Ce dessin est confidentiel et ne doit pas être reproduit ou utilisé sans le consentement de EXM

No.	Revisions	Date	By/Par

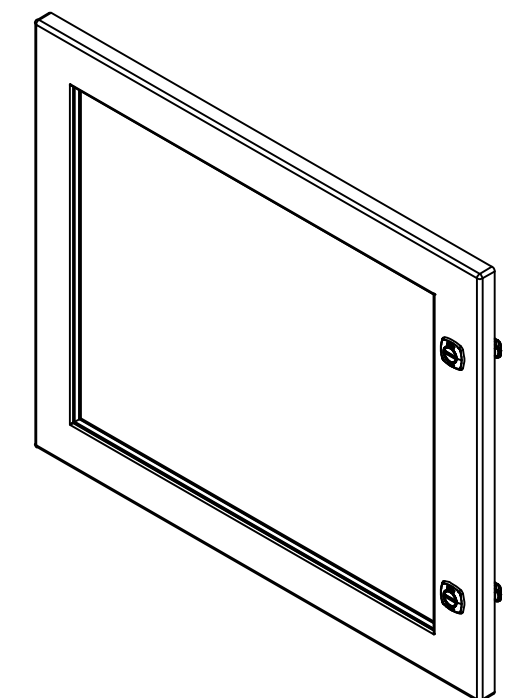

Isometric View

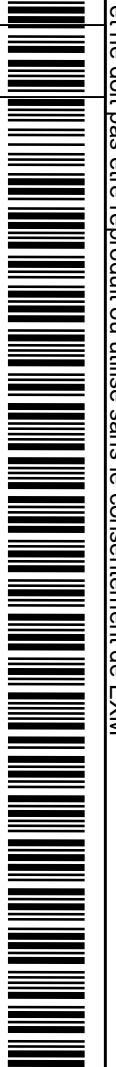

QTY	Part Number	Rev	Description
8	STK-Q-60701	2.1	880 WK - Lexan 1/4" Fixing Bracket
1	STK-A-60703	0	5412 ESW Lexan Bracket Kit
12	STK-Q-16053	1	Stud M6 x 23mm Stainless steel
1	STK-G-02710	0	880 HWKG - Windows Kit Gasket
1	5412ESSW2024066THNO IPLXG	0	5412ESSW 20" x 24" Lexan Gasket Part
1	5412ESSW2024066THNO IPLX	0	5412ESSW 16.375" x 20.125" Lexan Part
1	5412ESSW2024066THNO IPG	0	5412ESSW 20" x 24" Cover Gasket Part
1	5412ESSW2024066THNO IPC-P	0	5412ESSW 20" x 24" Cover Part
2	880 SCQ4-SLSS6	7	5412 ESS 1/4 Turn Lock
2	STK-A-33016	0	5412 ESS Bended Hinge (Body Part)
Parts List			



Tél: (450) 979-4373
Fax: (450) 979-4626
www.exmweb.com

Flatness
Aplatissement
Max 5.0mm

Projection

Customer Client

Drawn By / Dessiné Par: BoxCad: BoxCad

Material / Matière: 16 Ga Stainless Steel 316 (1.4mm)

Color / Couleur: Unpainted

Finish / Fini: Brushed

Description: 5412ESSW 20" x 24" Cover

Part Number / Numéro Pièce: 5412ESSW2024066THNOIPC

Rev. 10

This drawing is confidential and must not be reproduced or used without the consent of EXM

Ce dessin est confidentiel et ne doit pas être reproduit ou utilisé sans le consentement de EXM

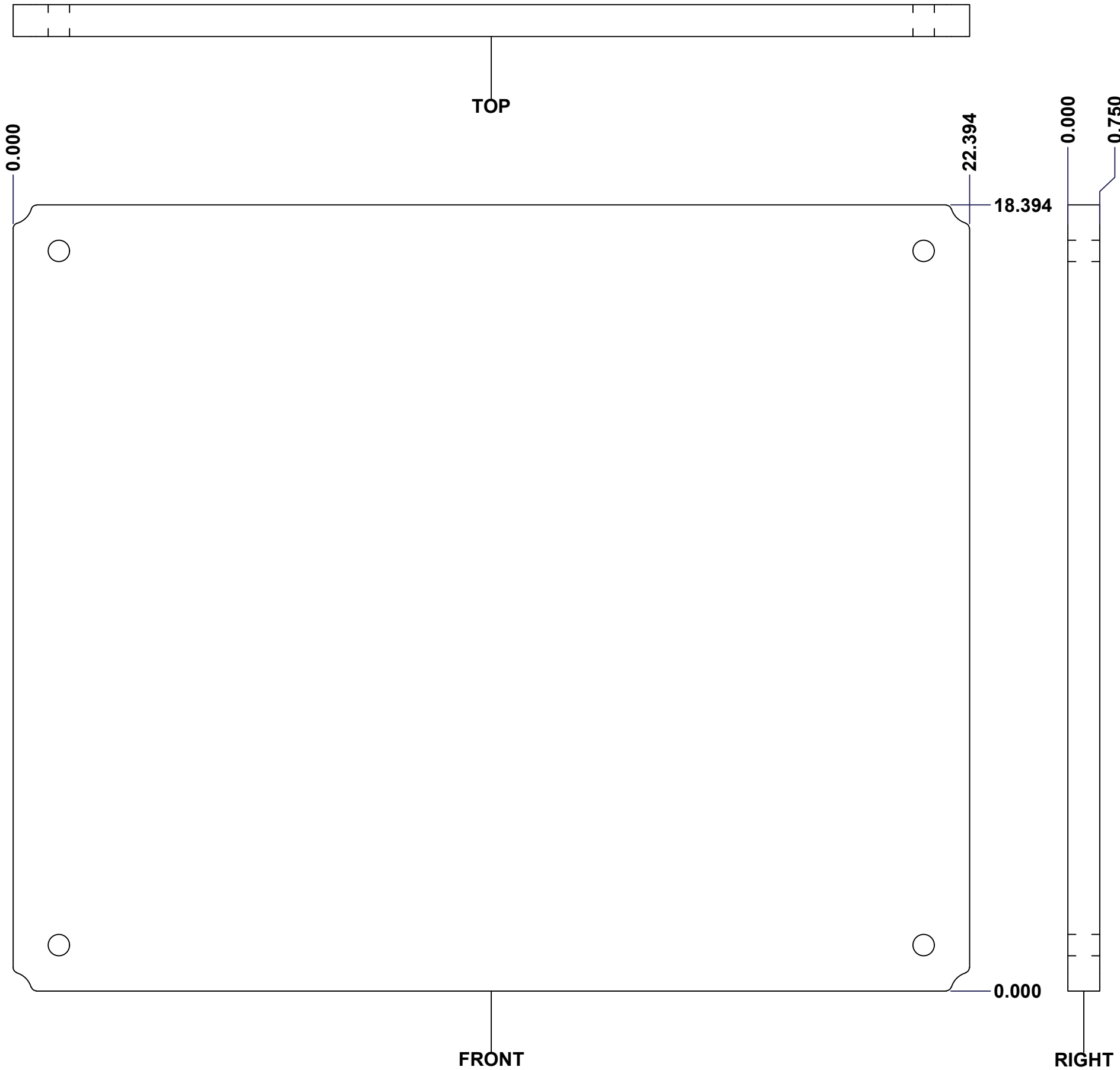

No.	Revisions	Date	By/Par

Isometric View

<p>Tél: (450) 979-4373 Fax: (450) 979-4626 www.exmweb.com</p>		Flatness Aplatissement
		Max 3.0mm
Customer Client		Projection
Drawn By / Dessiné Par: BoxCad: Patrick Deschenes		Date: 23-Jan-07
Material / Matière: Polyisocyanurate		
Color / Couleur: Aluminum	Finish / Fini: N/A	
Description: 5412ESSW 20" x 24" Back Insulation		Detail Rev.
Part Number / Numéro Pièce: 5412ESSW2024066THNOIP-B 0		Rev. 11

SEE BILL OF MATERIAL ON LAST PAGE 5412ESSW2024066THNOIP-B 0

This drawing is confidential and must not be reproduced or used without the consent of EXM

Ce dessin est confidentiel et ne doit pas être reproduit ou utilisé sans le consentement de EXM

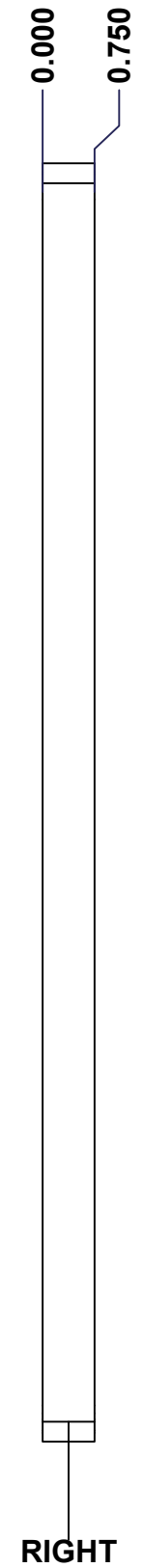
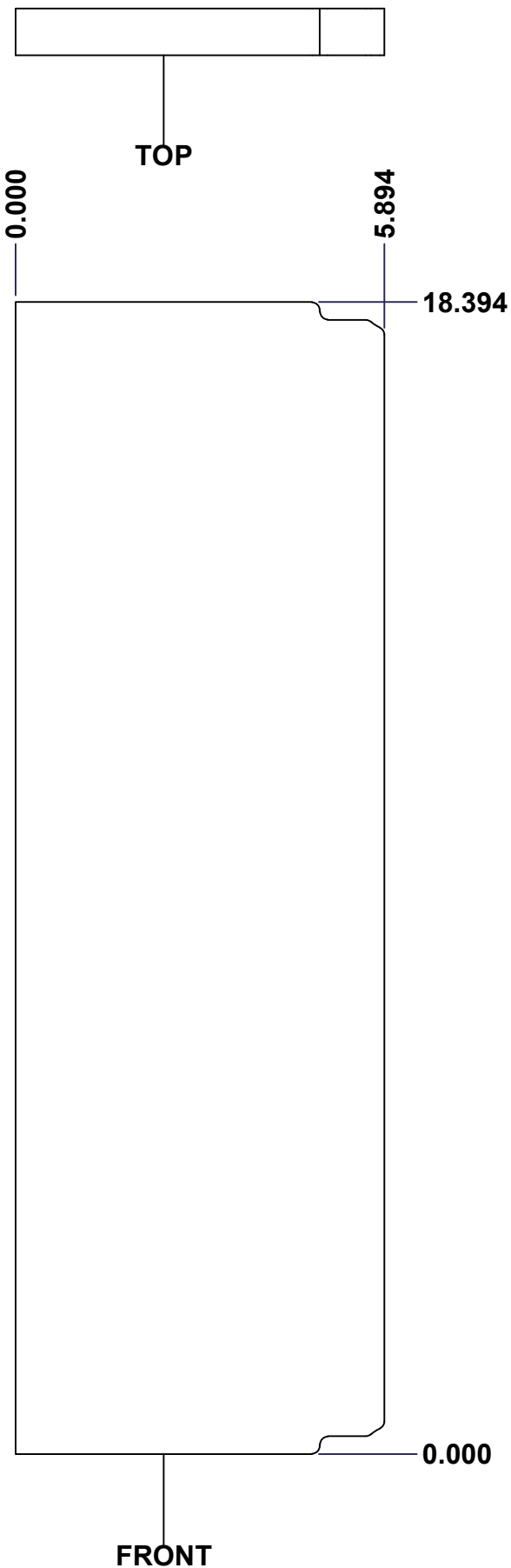

No.	Revisions	Date	By/Par

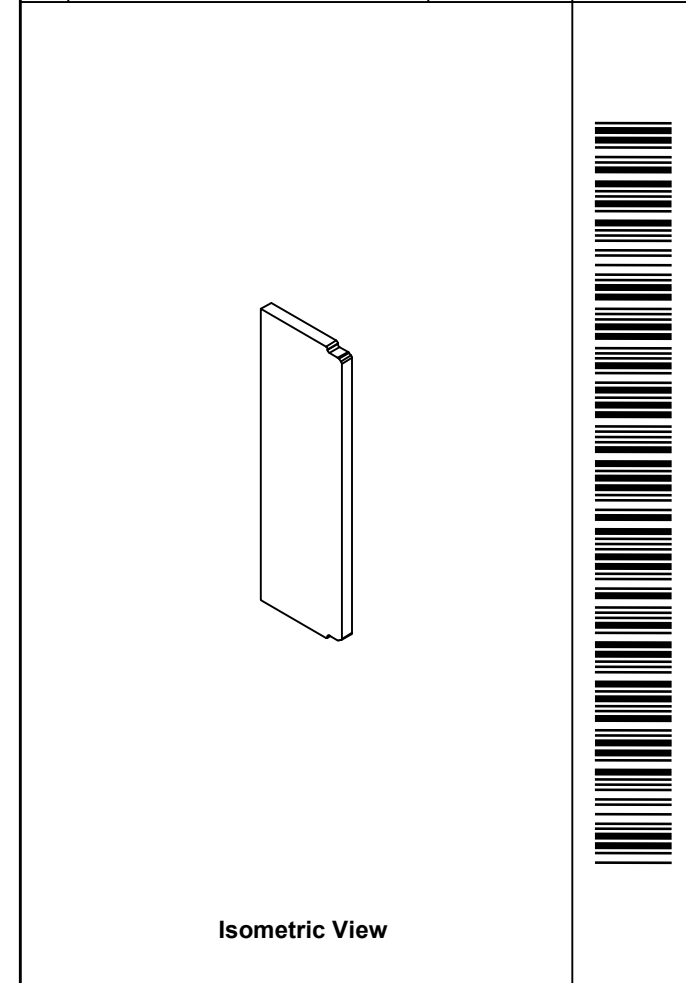

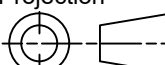
 Tél: (450) 979-4373 Fax: (450) 979-4626 www.exmweb.com		Flatness Aplatissement Max 3.0mm Projection 
Customer Client	Date	
Drawn By Dessiné Par	BoxCad: Patrick Deschenes	Date 23-Jan-07
Material Matière	Polyisocyanurate	
Color Couleur	Aluminum	Finish Fini N/A
Description	Detail Rev.	
5412ESSW 20" x 24" Left Insulation		
Part Number Numéro Pièce	Rev.	12
5412ESSW2024066THNOIP-L	S0	15

SEE BILL OF MATERIAL ON LAST PAGE

This drawing is confidential and must not be reproduced or used without the consent of EXM

Ce dessin est confidentiel et ne doit pas être reproduit ou utilisé sans le consentement de EXM

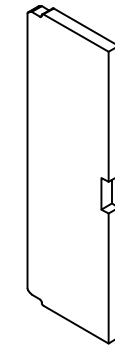
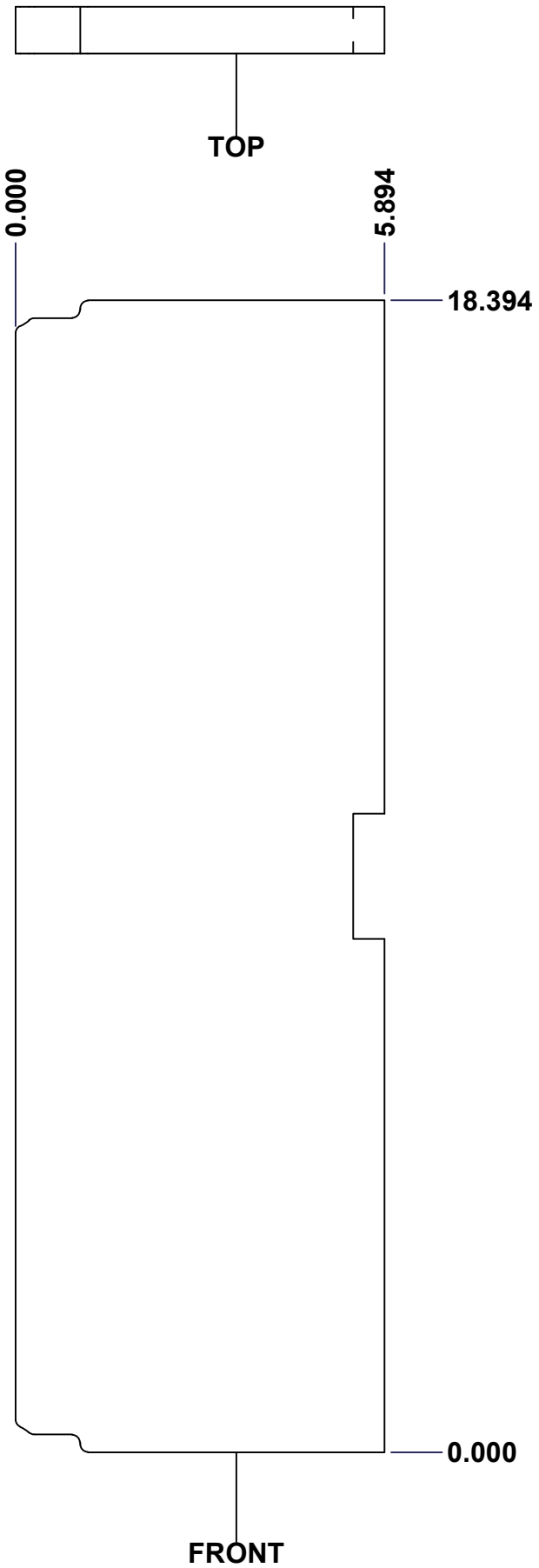

Isometric View



No.	Revisions	Date	By/Par

 Tél: (450) 979-4373 Fax: (450) 979-4626 www.exmweb.com		Flatness Aplatissement Max 3.0mm
Customer Client		Date
Drawn By / Dessiné Par: BoxCad: Patrick Deschenes		Date: 23-Jan-07
Material / Matière: Polyisocyanurate		
Color / Couleur: Aluminum	Finish / Fini: N/A	
Description: 5412ESSW 20" x 24" Right Insulation		Detail Rev.
Part Number / Numéro Pièce: 5412ESSW2024066THNOIP-RS0		Rev. 13

SEE BILL OF MATERIAL ON LAST PAGE 15

This drawing is confidential and must not be reproduced or used without the consent of EXM

Ce dessin est confidentiel et ne doit pas être reproduit ou utilisé sans le consentement de EXM



TOP

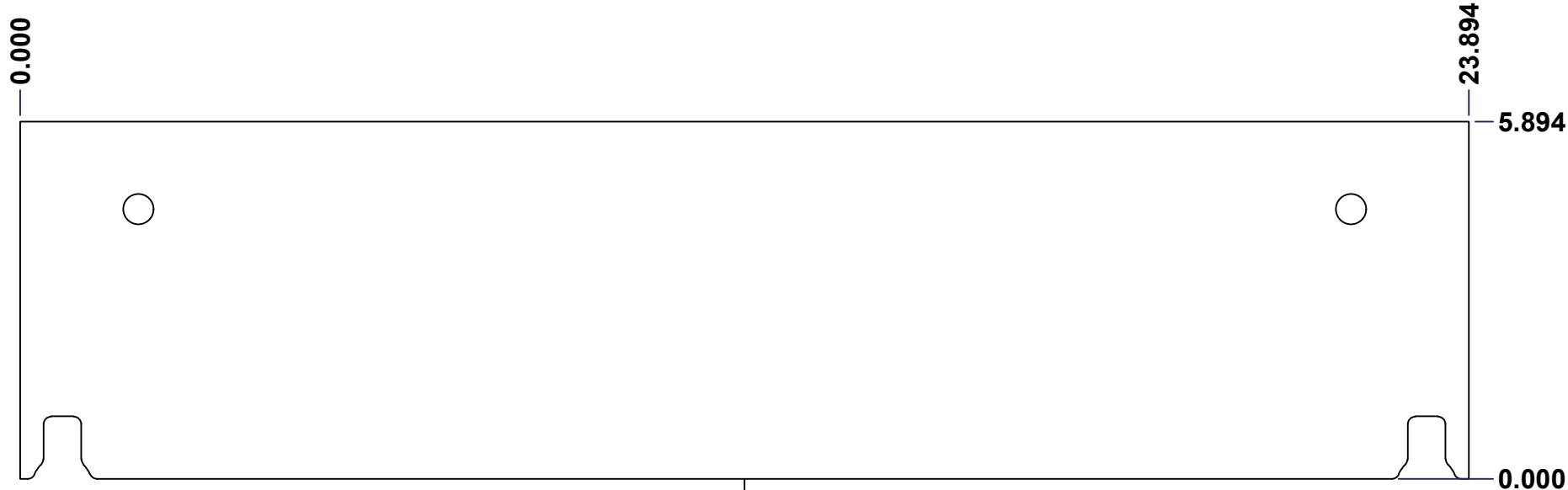

FRONT

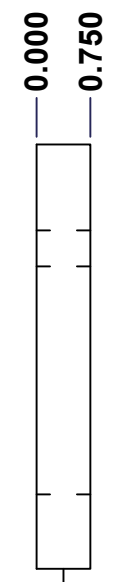

RIGHT

No.	Revisions	Date	By/Par

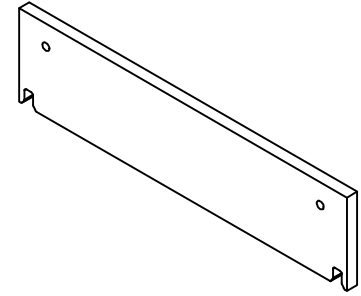

Isometric View



Tél: (450) 979-4373
 Fax: (450) 979-4626
www.exmweb.com

Flatness
 Aplatissement
 Max 3.0mm
 Projection

Customer Client	Date
Drawn By / Dessiné Par: BoxCad: Patrick Deschenes	Date: 23-Jan-07
Material / Matière: Polyisocyanurate	
Color / Couleur: Aluminum	Finish / Fini: N/A
Description: 5412ESSW 20" x 24" Top and Bottom Insulation	Detail Rev.

Part Number / Numéro Pièce	Rev.	14
----------------------------	------	----

SEE BILL OF MATERIAL ON LAST PAGE 5412ESSW2024066THNOIPI-TP0

This drawing is confidential and must not be reproduced or used without the consent of EXM

Ce dessin est confidentiel et ne doit pas être reproduit ou utilisé sans le consentement de EXM



TOP

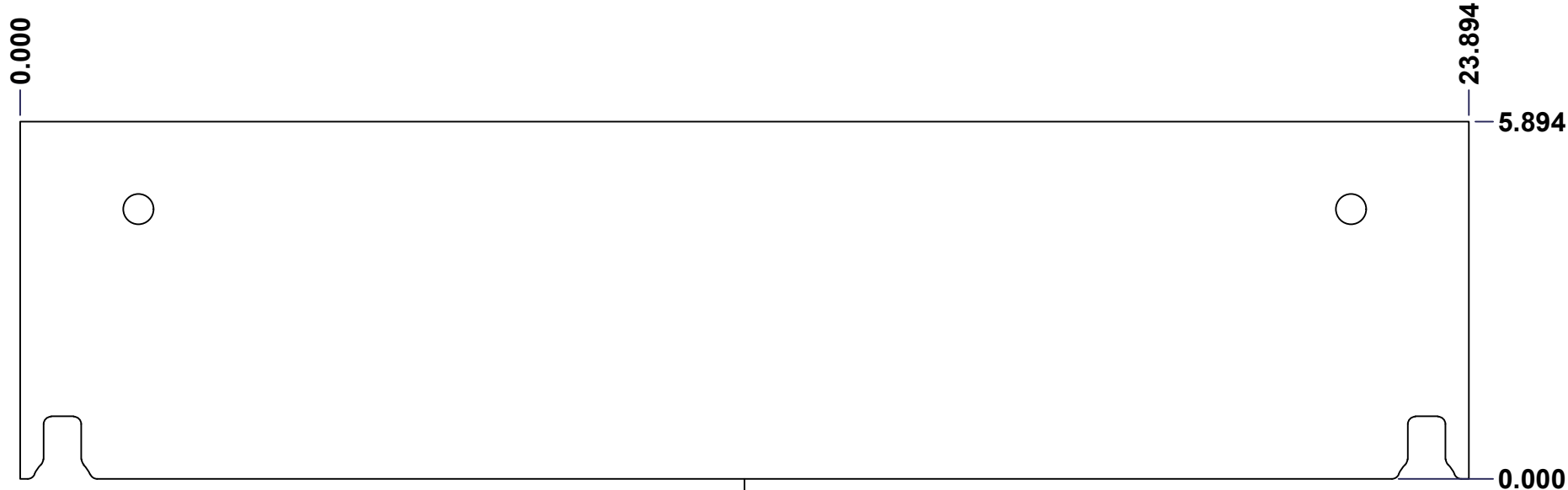

FRONT

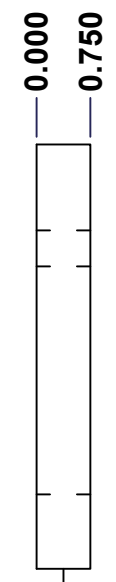

RIGHT

No.	Revisions	Date	By/Par

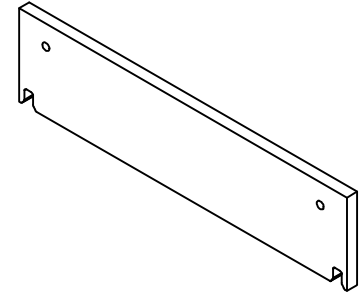

Isometric View



Tél: (450) 979-4373
 Fax: (450) 979-4626
www.exmweb.com

Flatness
Aplatissement
Max 3.0mm
Projection

Customer Client	Date
Drawn By / Dessiné Par: BoxCad: Patrick Deschenes	Date: 23-Jan-07
Material / Matière: Polyisocyanurate	
Color / Couleur: Aluminum	Finish / Fini: N/A
Description: 5412ESSW 20" x 24" Top and Bottom Insulation	Detail Rev.

Part Number / Numéro Pièce	Rev.	15
----------------------------	------	----

SEE BILL OF MATERIAL ON LAST PAGE 5412ESSW2024066THNOIPI-BT0