

This drawing is confidential and must not be reproduced or used without the consent of EXM

Ce dessin est confidentiel et ne doit pas être reproduit ou utilisé sans le consentement de EXM

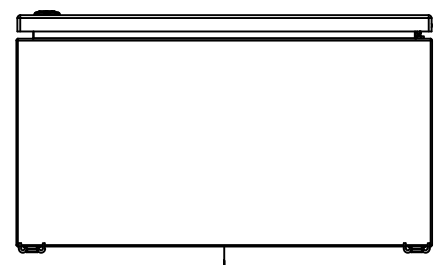

TOP

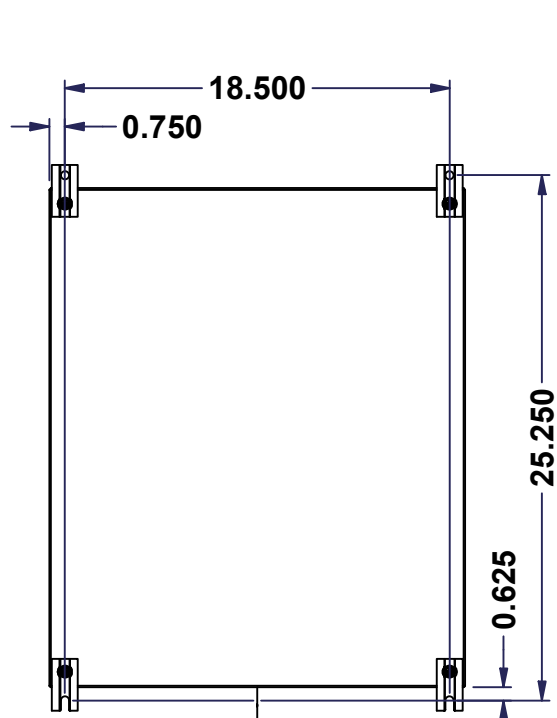

BACK

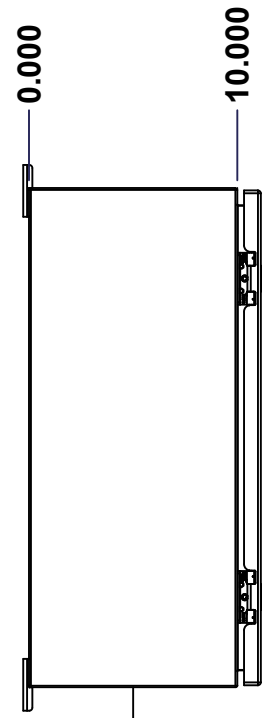

LEFT

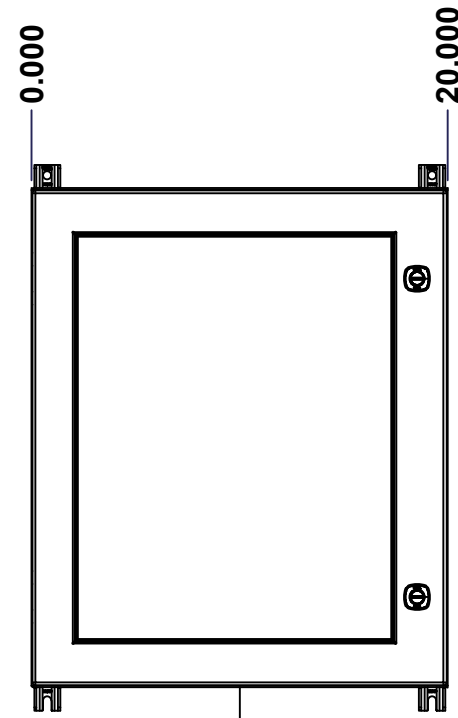

FRONT

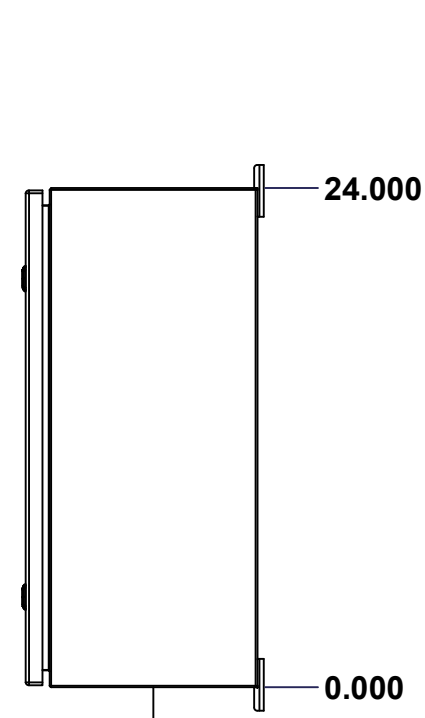

RIGHT

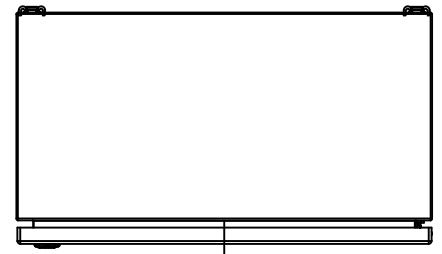

BOTTOM

No.	Revisions	Date	By/Par

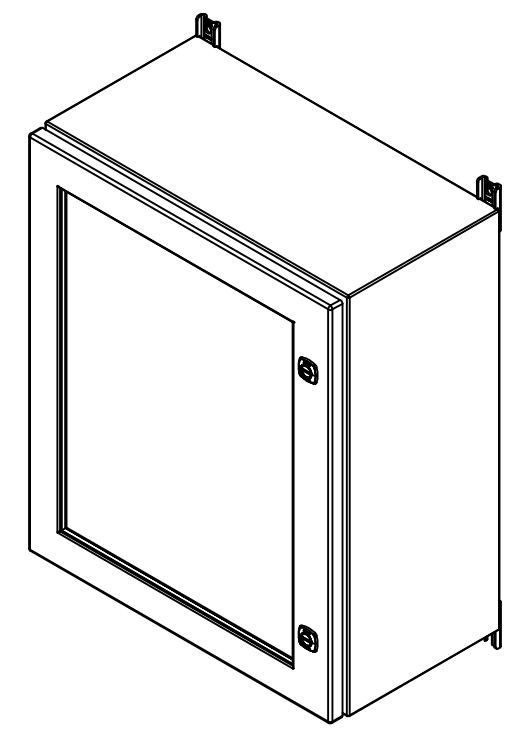

Isometric View

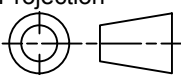

**GRAIN DIRECTION:  
TOP/BOTTOM: HORIZONTAL  
LEFT/RIGHT/BACK/FRONT: VERTICAL**

 Tél: (450) 979-4373 Fax: (450) 979-4626 <a href="http://www.exmweb.com">www.exmweb.com</a>		Flatness Aplatissement Max 3.0mm Projection 
Customer Client	Date	
Drawn By Dessiné Par	BoxCad: BoxCad	Date 19-Jun-23
Material Matière	16 Ga Stainless Steel 316 (1.4mm)	
Color Couleur	Unpainted	Finish Fini Brushed
Description	Detail Rev.	
5412ESSW 24" x 20" x 10" Assembly		
Part Number Numéro Pièce	Rev. 0	1 / 15

SEE BILL OF MATERIAL ON LAST PAGE 5412ESSW2420106THNOIP

This drawing is confidential and must not be reproduced or used without the consent of EXM

Ce dessin est confidentiel et ne doit pas être reproduit ou utilisé sans le consentement de EXM

NOTE	
ITEM	DESCRIPTION
1	NEMA 4X Enclosure
2	C/W Standard ground studs on box and cover
3	W/O Standard door stiffener
4	W/O Inner panel
5	C/W Standard inner panel mounting studs
6	C/W 885 ESMF4_OPEN Sold separately (Installed)
7	C/W 885 ESMF4_CLOSE Sold separately (Installed)
8	C/W R5 Insulation (Installed by EXM)

No.	Revisions	Date	By/Par

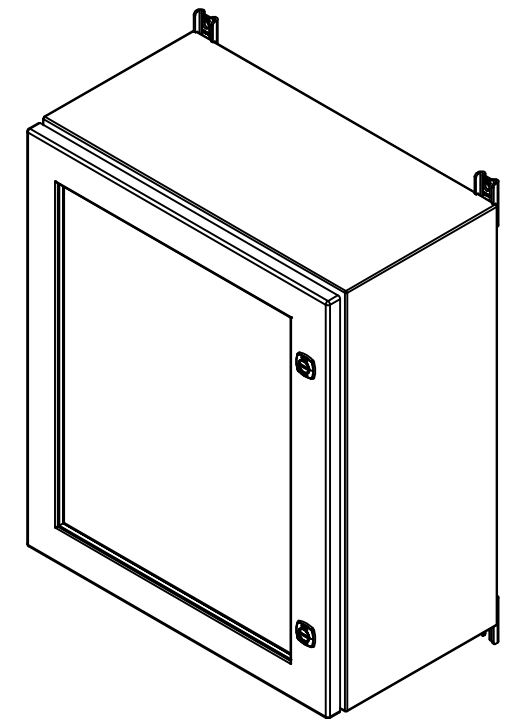

Isometric View

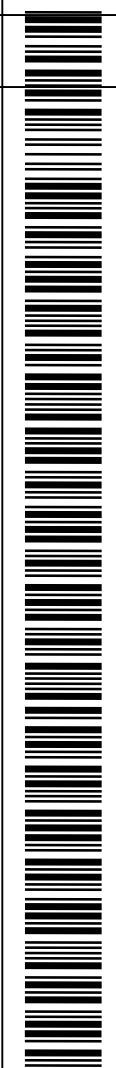

Tél: (450) 979-4373  
 Fax: (450) 979-4626  
[www.exmweb.com](http://www.exmweb.com)

Flatness  
Aplatissement  
Max 3.0mm  
Projection

Customer Client	Date
Drawn By Dessiné Par BoxCad: BoxCad	Date 19-Jun-23

Material Matière 16 Ga Stainless Steel 316 (1.4mm)

Color Couleur Unpainted	Finish Fini Brushed
-------------------------	---------------------

Description 5412ESSW 24" x 20" x 10" Assembly  
 Detail Rev.

Part Number Numéro Pièce	Rev. 0	2	15
-----------------------------	--------	---	----

Qty	Part Number	Rev	Description
4	STK-Q-00600	2	M12 to M8 Adaptor
1	STK-K-01800	5	5412 ES Accessory Kit
1	5412ESSW2420106THNO IPC	0	5412ESSW 24" x 20" Cover
1	5412ESSW2420106THNO IPB	0	5412ESSW 24" x 20" x 10" Body
2	STK-Q-04051-08	1	M6 x 8mm Stainless Steel Hexagon Socket Head Machine Screw with Nyseal
Parts List			

PACKING		
ITEM	QTY	DESCRIPTION
Cardboard sleeve	2	Top and Bottom
Cardboard strip	2	Between back of enclosure and inner panel
Plastic bag	1	To protect cover surface and inside gasket
Plastic strap - Black	2	To Squeeze the 2 cardboard sleeve together
Packaging label	1	White label with product number

This drawing is confidential and must not be reproduced or used without the consent of EXM

Ce dessin est confidentiel et ne doit pas être reproduit ou utilisé sans le consentement de EXM

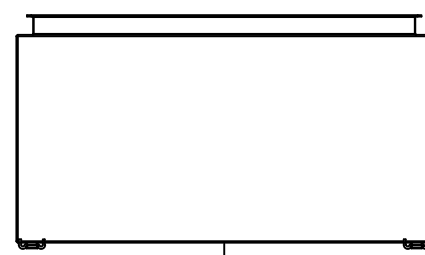

TOP

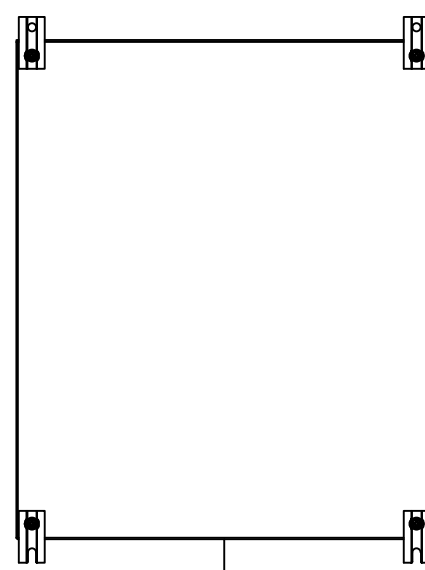

BACK

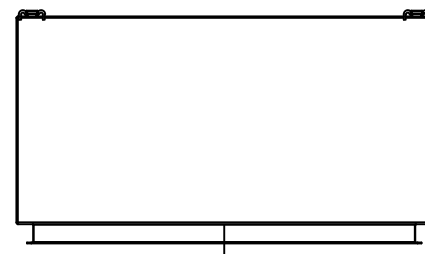

BOTTOM

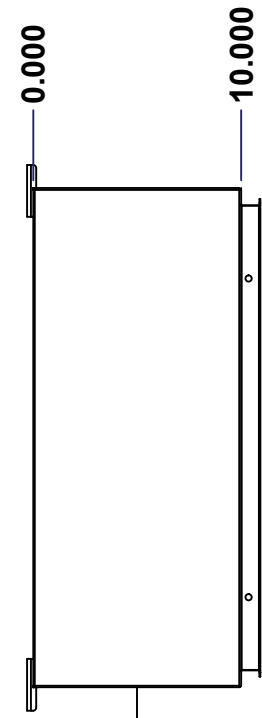

LEFT

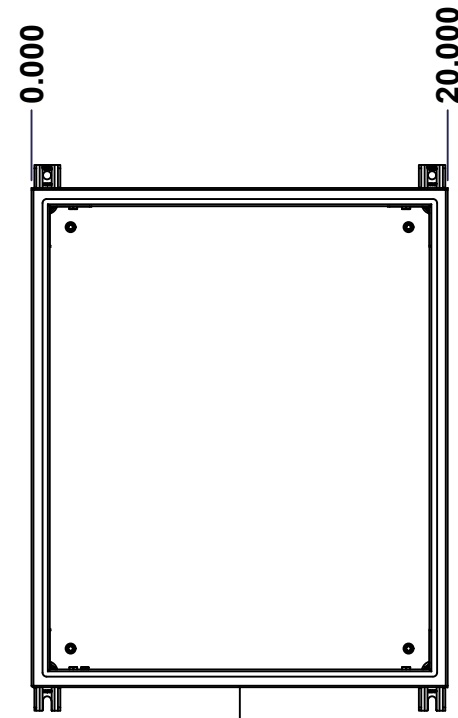

FRONT

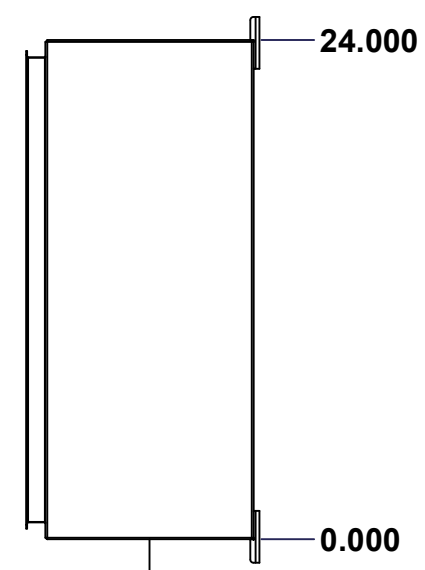

RIGHT

No.	Revisions	Date	By/Par

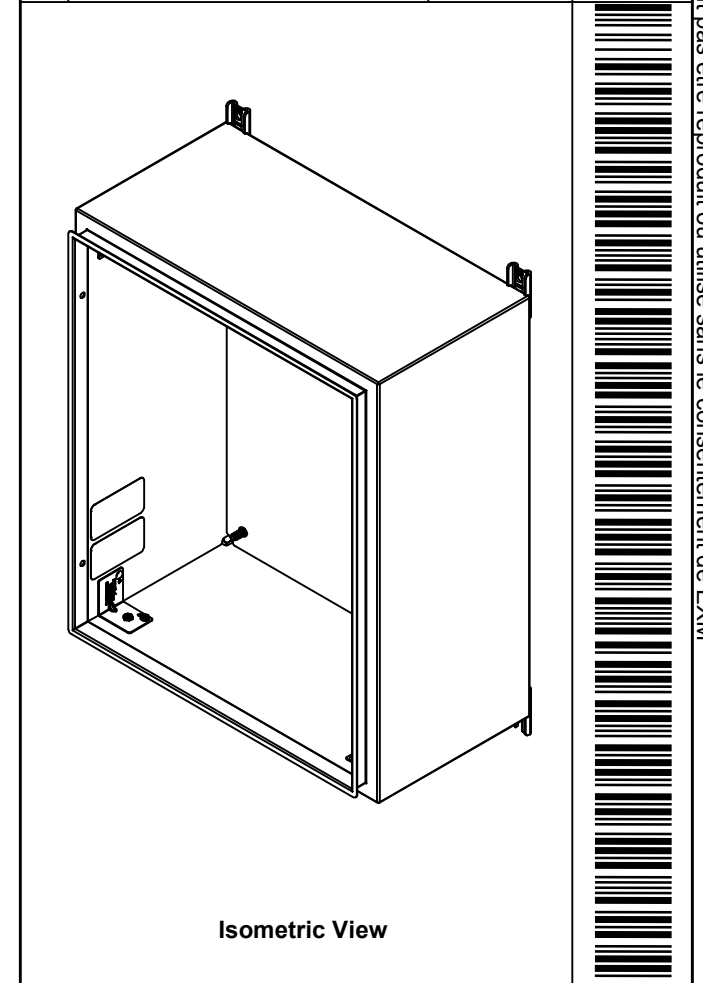

Isometric View

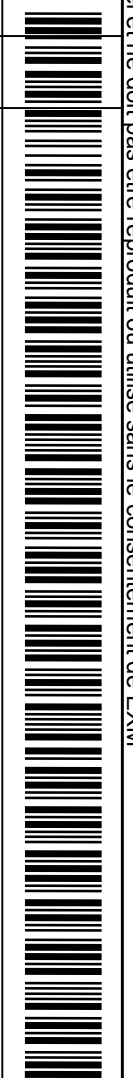

 Tél: (450) 979-4373 Fax: (450) 979-4626 <a href="http://www.exmweb.com">www.exmweb.com</a>		Flatness Aplatissement Max 5.0mm Projection
Customer Client	Date	
Drawn By Dessiné Par	BoxCad: BoxCad	Date 19-Jun-23
Material Matière	16 Ga Stainless Steel 316 (1.4mm)	
Color Couleur	Unpainted	Finish Fini Brushed
Description	Detail Rev.	
5412ESSW 24" x 20" x 10" Body		
Part Number Numéro Pièce	Rev.	3
		15

SEE BILL OF MATERIAL ON LAST PAGE 5412ESSW2420106THNOIPB 0

This drawing is confidential and must not be reproduced or used without the consent of EXM

Ce dessin est confidentiel et ne doit pas être reproduit ou utilisé sans le consentement de EXM

STANDARD FEATURES ARE NOT LISTED IN THIS HOLE TABLE			
HOLE TABLE - TOP VIEW (CUSTOM FEATURE ONLY)			
CUT-OUT	XDIM	YDIM	DESCRIPTION
1	2.000	8.500	INSUL. STUD M6 x 18mm (Inside)
2	18.000	8.500	INSUL. STUD M6 x 18mm (Inside)

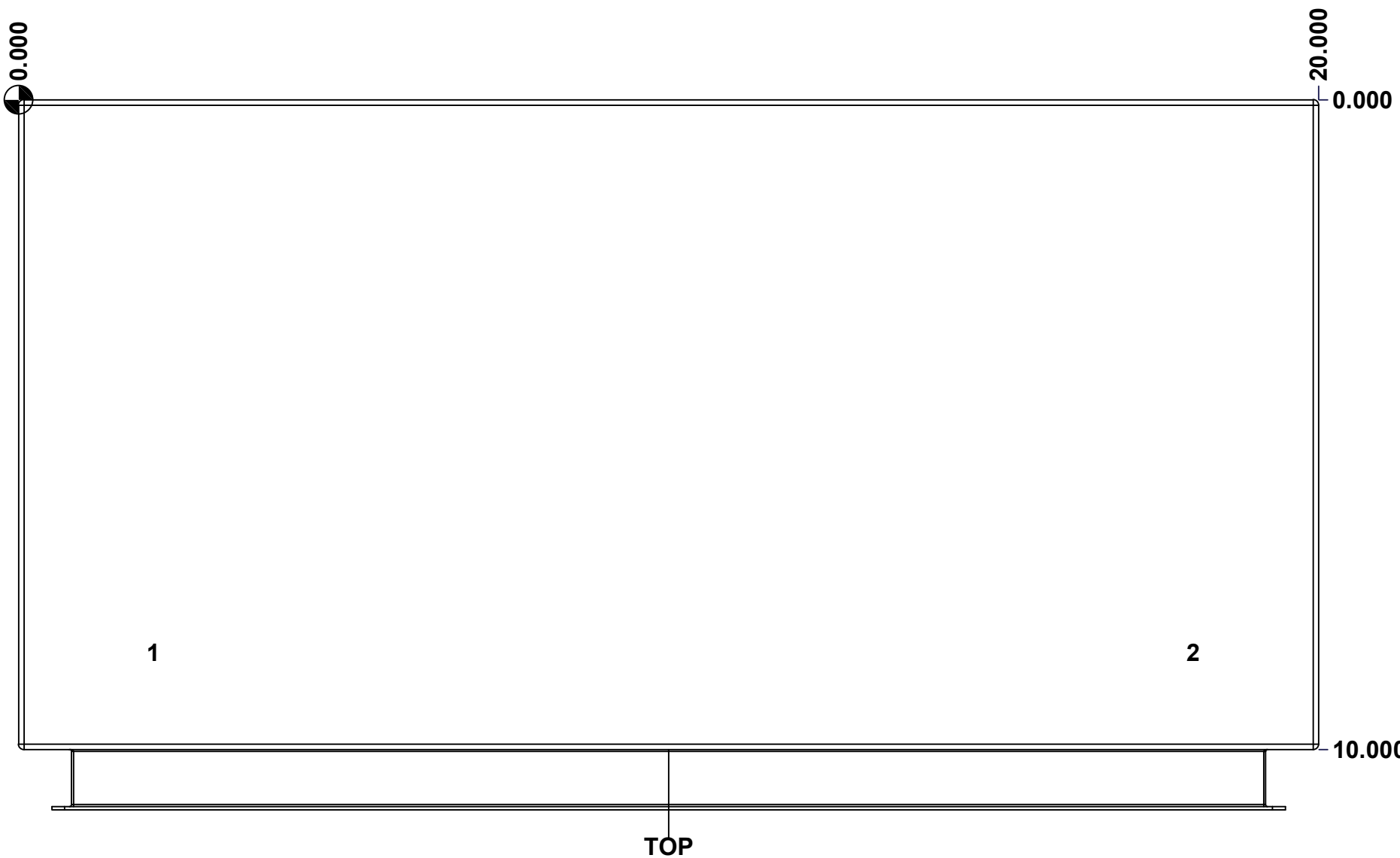

	Description	Status
	5412ESSW 24" x 20" x 10" Body	(NULL)
	Part Number Numéro Pièce	Rev.
	<b>5412ESSW2420106THNOIPB 0</b>	4
		15

This drawing is confidential and must not be reproduced or used without the consent of EXM

Ce dessin est confidentiel et ne doit pas être reproduit ou utilisé sans le consentement de EXM

<b>STANDARD FEATURES ARE NOT LISTED IN THIS HOLE TABLE</b>			
<b>HOLE TABLE - BOTTOM VIEW (CUSTOM FEATURE ONLY)</b>			
CUT-OUT	XDIM	YDIM	DESCRIPTION
1	2.000	8.500	INSUL. STUD M6 x 18mm (Inside)
2	18.000	8.500	INSUL. STUD M6 x 18mm (Inside)

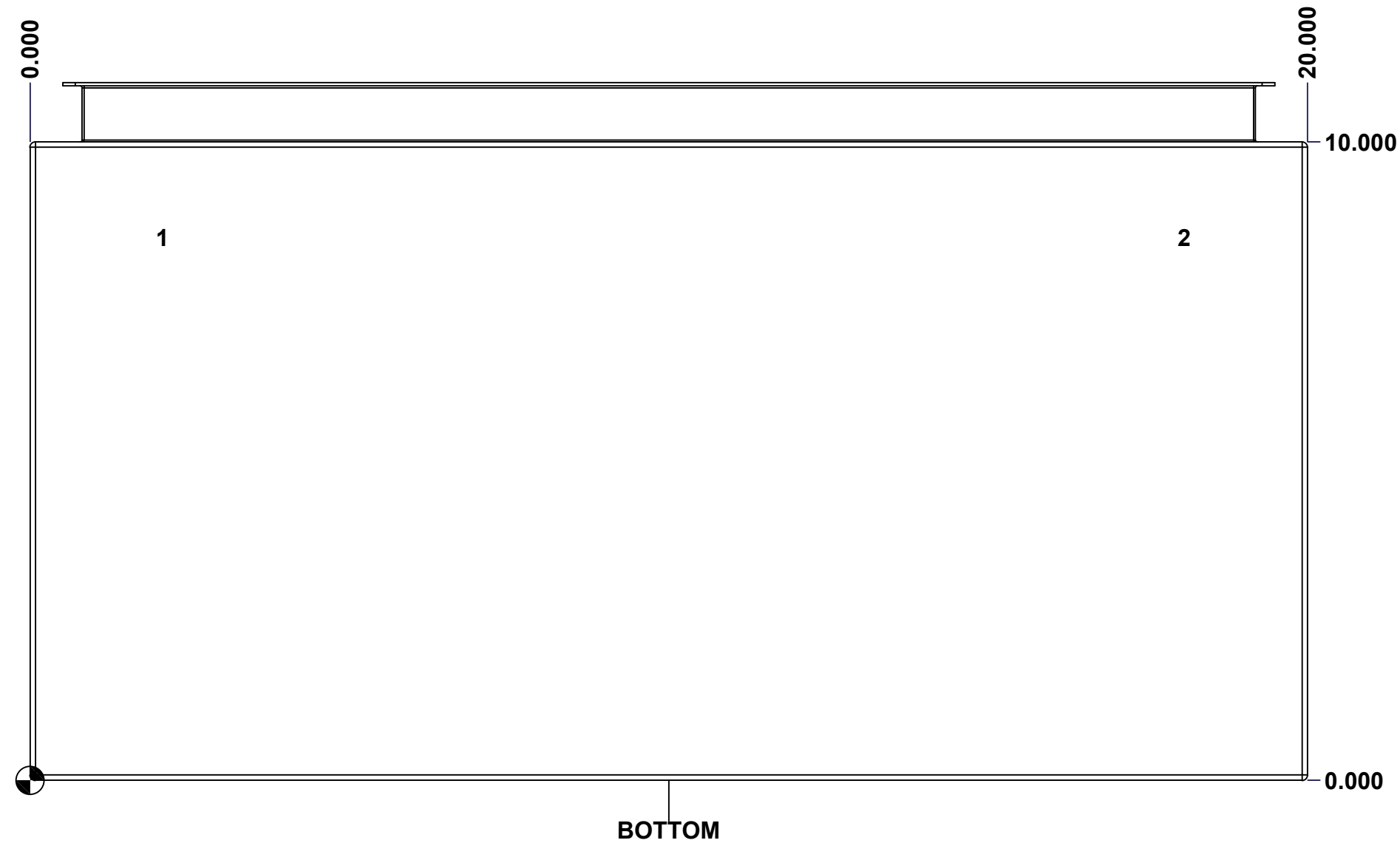

	Description		Status
	5412ESSW 24" x 20" x 10" Body		(NULL)
Part Number Numéro Pièce		Rev.	5
<b>5412ESSW2420106THNOIPB 0</b>			15

This drawing is confidential and must not be reproduced or used without the consent of EXM

Ce dessin est confidentiel et ne doit pas être reproduit ou utilisé sans le consentement de EXM

**STANDARD FEATURES ARE NOT LISTED IN THIS HOLE TABLE**

**HOLE TABLE - BACK VIEW (CUSTOM FEATURE ONLY)**

CUT-OUT	XDIM	YDIM	DESCRIPTION
1	1.875	1.875	IP STUD M8 x 35mm (Inside)
2	1.875	22.125	IP STUD M8 x 35mm (Inside)
3	18.125	22.125	IP STUD M8 x 35mm (Inside)
4	18.125	1.875	IP STUD M8 x 35mm (Inside)
-----			
5	19.250	0.000	FOOT 885 ESMF4_OPEN
6	0.750	0.000	FOOT 885 ESMF4_OPEN
7	19.250	24.000	FOOT 885 ESMF4_CLOSE
8	0.750	24.000	FOOT 885 ESMF4_CLOSE

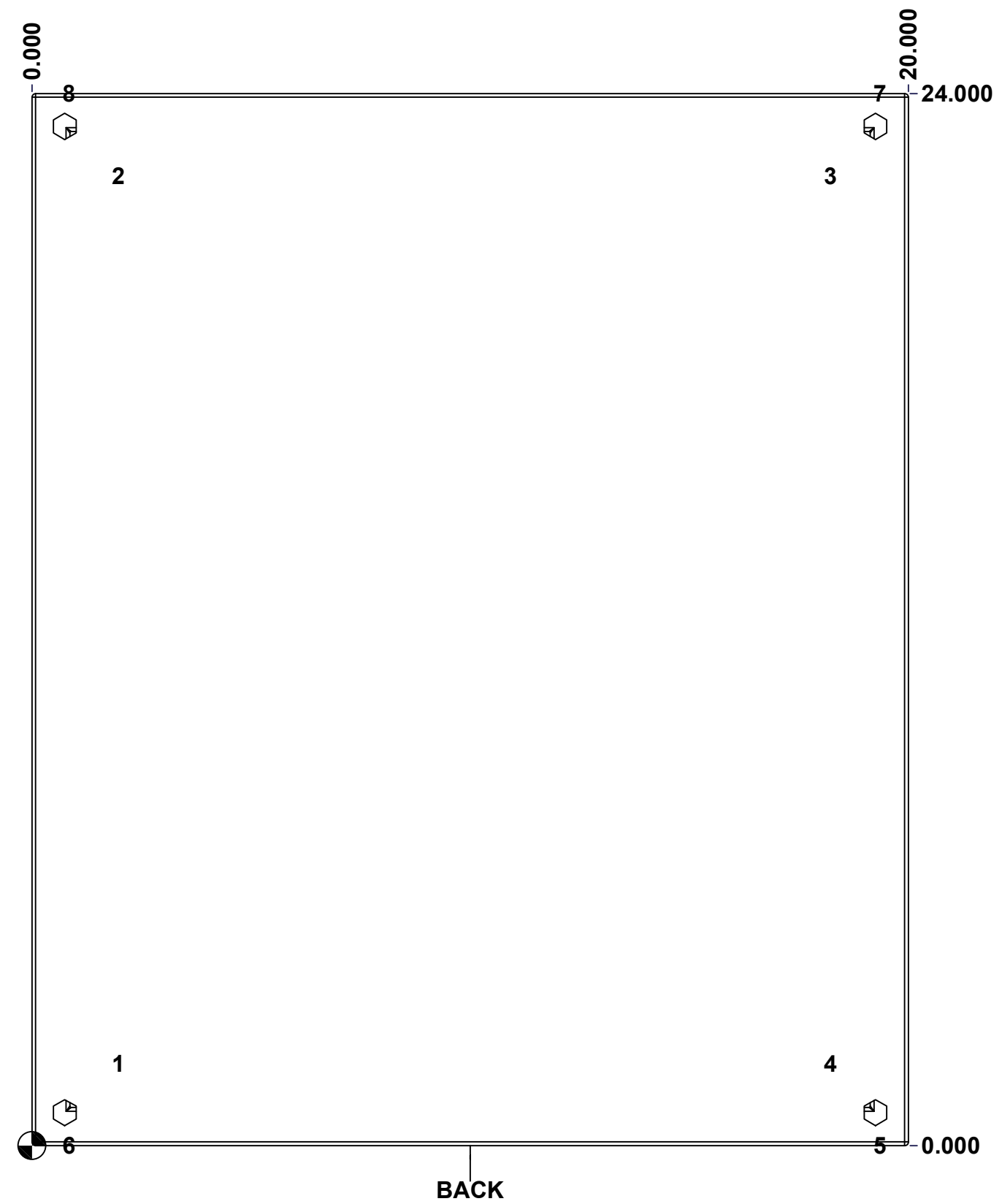

BACK

	Description	Status
	5412ESSW 24" x 20" x 10" Body	(NULL)
	Part Number Numéro Pièce	Rev.
	<b>5412ESSW2420106THNOIPB 0</b>	6
		15

This drawing is confidential and must not be reproduced or used without the consent of EXM

Ce dessin est confidentiel et ne doit pas être reproduit ou utilisé sans le consentement de EXM

No.	Revisions	Date	By/Par

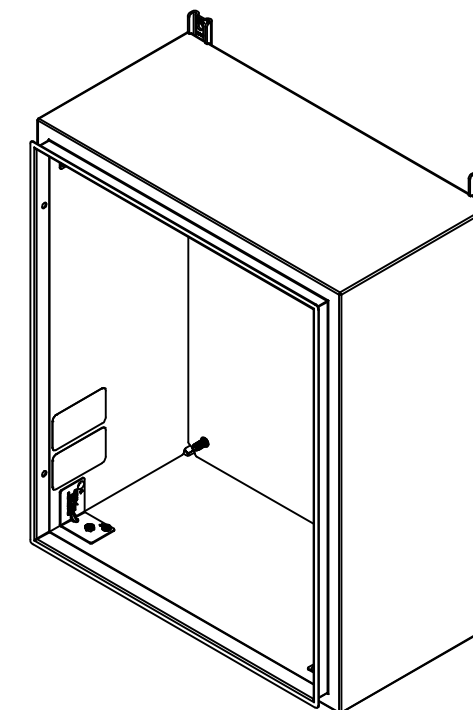

Isometric View



2	885ESMF4-FEET	0	885 ESMF4 Stainless Steel Mounting Foot
4	RIVET_NUT_SS_M10_FH_CE	0	Stainless Steel Rivet Nut M10 (Low Profile Close End)
4	STK-Q-06670	2	M10 x 16mm Stainless Steel Machine Screw
2	885ESMF4-FEET-A	0	885 ESMF4 Stainless Steel Mounting Foot (Opened Slot)
2	STK-S-00100	0	3.5" x 2" Silver Milar Flexcon Sticker
1	STK-K-70554	3	5412 ESTH Accessory Kit
1	5412ESSW2420106THNO IPI-RS	0	5412ESSW 24" x 20" Right Insulation
1	5412ESSW2420106THNO IPI-LS	0	5412ESSW 24" x 20" Left Insulation
1	5412ESSW2420106THNO IPI-BT	0	5412ESSW 24" x 20" Top and Bottom Insulation
1	5412ESSW2420106THNO IPI-TP	0	5412ESSW 24" x 20" Top and Bottom Insulation
1	5412ESSW2420106THNO IPI-B	0	5412ESSW 24" x 20" Back Insulation
4	STK-Q-16070	1	Stud M6 x 18mm Stainless steel
4	STK-Q-16020	1	Stud M8 x 35mm Stainless Steel
1	5412ESSW2420106THNO IPB-P	0	5412ESSW 24" x 20" x 10" Body Part

Qty	Part Number	Rev	Description
Parts List			

 Tél: (450) 979-4373 Fax: (450) 979-4626 <a href="http://www.exmweb.com">www.exmweb.com</a>		Flatness Aplatissement Max 5.0mm Projection
Customer Client	Date	
Drawn By Dessiné Par	BoxCad: BoxCad	Date 19-Jun-23
Material Matière	16 Ga Stainless Steel 316 (1.4mm)	
Color Couleur	Unpainted	Finish Fini Brushed
Description	Detail Rev.	
5412ESSW 24" x 20" x 10" Body		
Part Number Numéro Pièce	Rev.	7
5412ESSW2420106THNOIPB 0		15

This drawing is confidential and must not be reproduced or used without the consent of EXM

Ce dessin est confidentiel et ne doit pas être reproduit ou utilisé sans le consentement de EXM

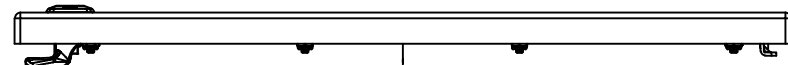

TOP

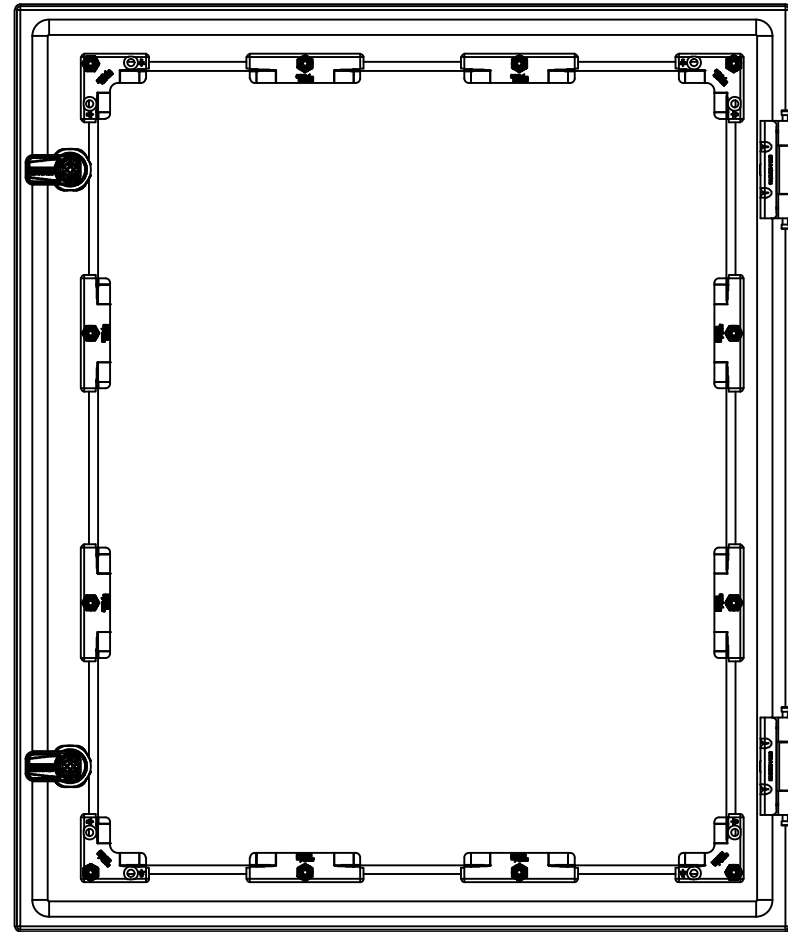

BACK

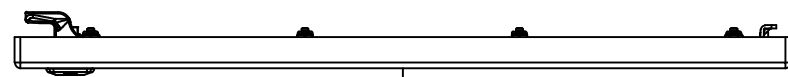

BOTTOM

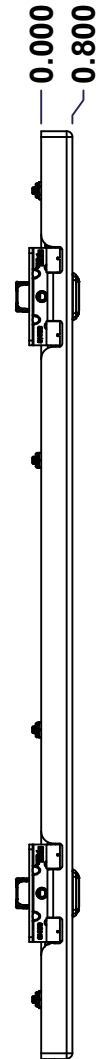

LEFT

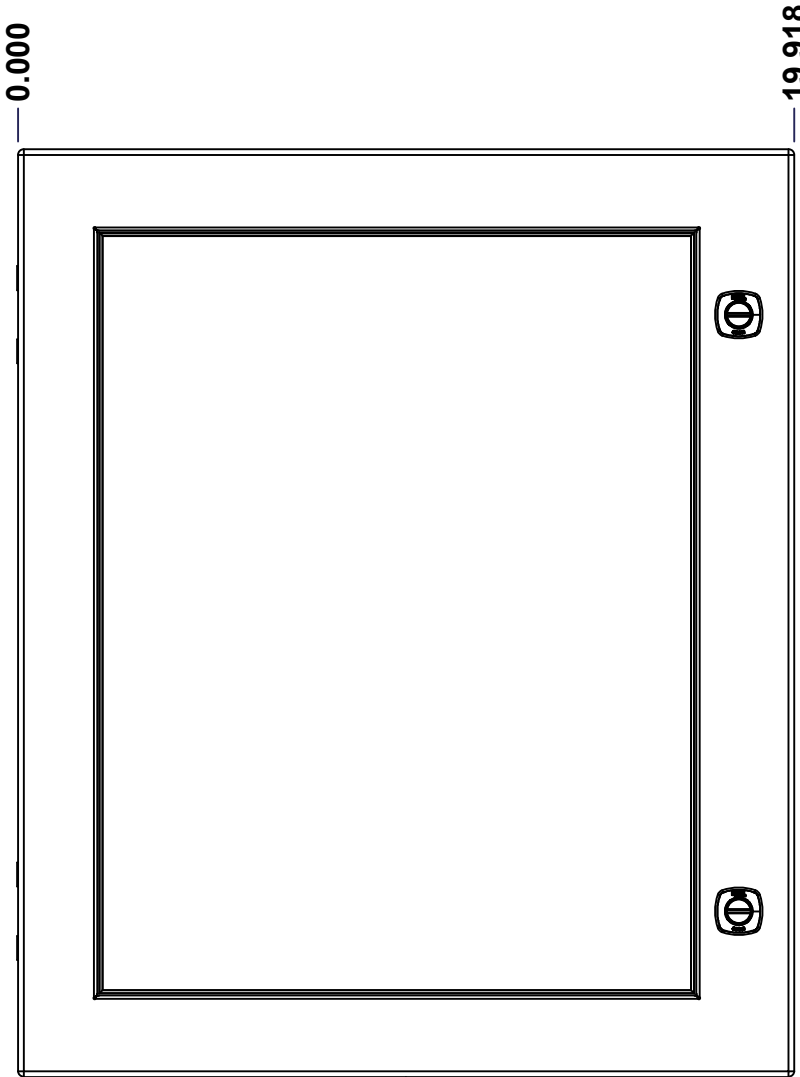

FRONT

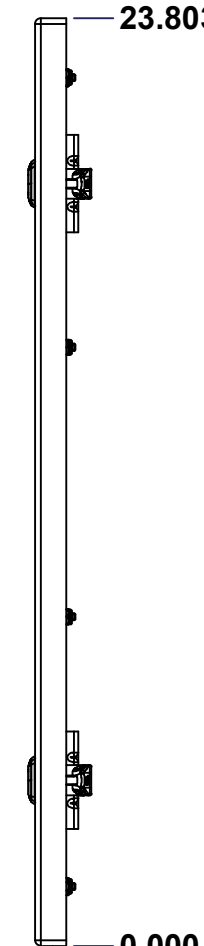

RIGHT

No.	Revisions	Date	By/Par

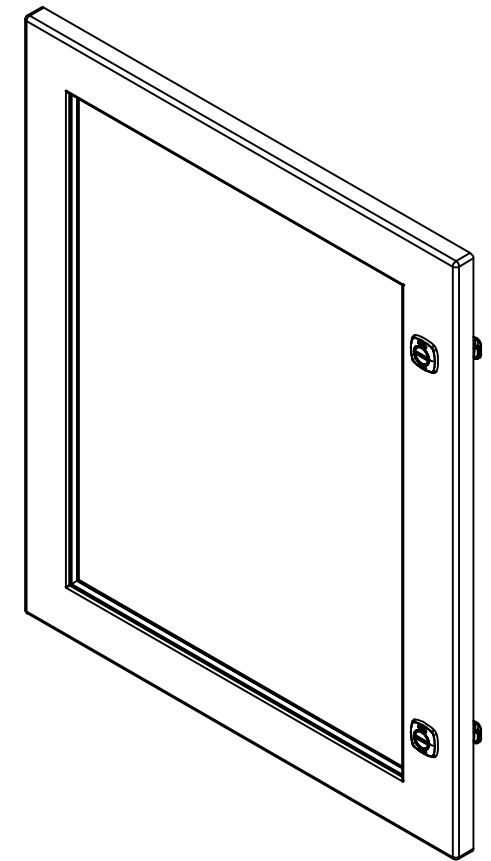

Isometric View



Tél: (450) 979-4373  
 Fax: (450) 979-4626  
[www.exmweb.com](http://www.exmweb.com)

Flatness  
 Aplatissement  
 Max 5.0mm  
 Projection

Customer Client	Date
Drawn By Dessiné Par BoxCad: BoxCad	Date 19-Jun-23
Material Matière 16 Ga Stainless Steel 316 (1.4mm)	
Color Couleur Unpainted	Finish Fini Brushed
Description 5412ESSW 24" x 20" Cover	Detail Rev.
Part Number Numéro Pièce	Rev. 8

SEE BILL OF MATERIAL ON LAST PAGE 5412ESSW2420106THNOIPC 0



This drawing is confidential and must not be reproduced or used without the consent of EXM

Ce dessin est confidentiel et ne doit pas être reproduit ou utilisé sans le consentement de EXM

**STANDARD FEATURES ARE NOT LISTED IN THIS HOLE TABLE**

**HOLE TABLE - FRONT VIEW (CUSTOM FEATURE ONLY)**

CUT-OUT	XDIM	YDIM	DESCRIPTION
1	1.469	8.443	STUD M6 x 18mm (Inside)
2	17.968	8.443	STUD M6 x 18mm (Inside)
3	1.469	15.360	STUD M6 x 18mm (Inside)
4	17.968	15.360	STUD M6 x 18mm (Inside)
5	1.469	22.276	STUD M6 x 18mm (Inside)
6	1.469	1.527	STUD M6 x 18mm (Inside)
7	6.969	22.276	STUD M6 x 18mm (Inside)
8	6.969	1.527	STUD M6 x 18mm (Inside)
9	12.468	22.276	STUD M6 x 18mm (Inside)
10	12.468	1.527	STUD M6 x 18mm (Inside)
11	17.968	22.276	STUD M6 x 18mm (Inside)
12	17.968	1.527	STUD M6 x 18mm (Inside)
-----			
13	18.494	19.553	880 SCQ4-SLSS6
14	18.494	4.250	880 SCQ4-SLSS6

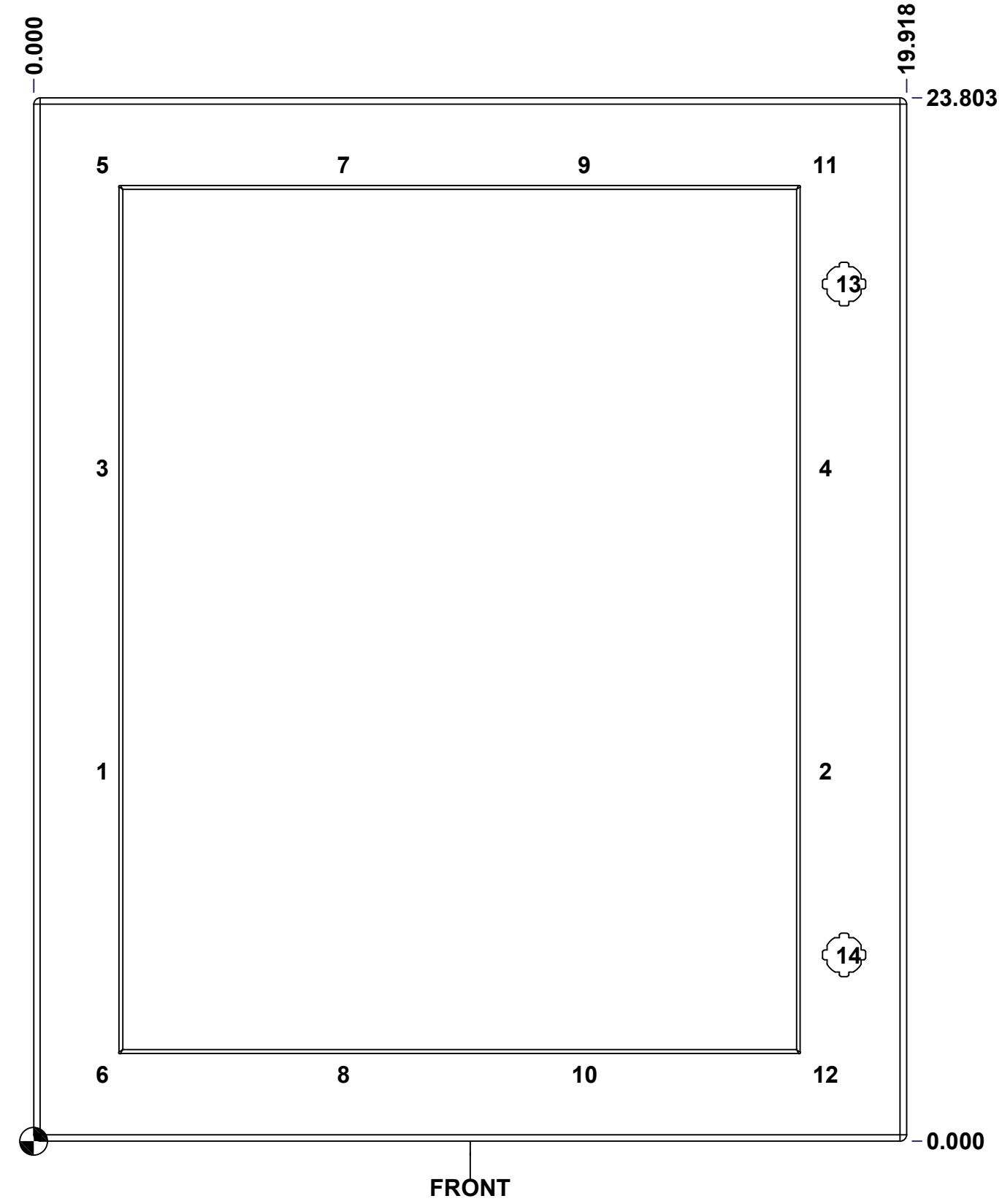

	Description	Status
	5412ESSW 24" x 20" Cover	(NULL)
	Part Number Numéro Pièce	Rev.
	<b>5412ESSW2420106THNOIPC 0</b>	9
		15



This drawing is confidential and must not be reproduced or used without the consent of EXM

Ce dessin est confidentiel et ne doit pas être reproduit ou utilisé sans le consentement de EXM

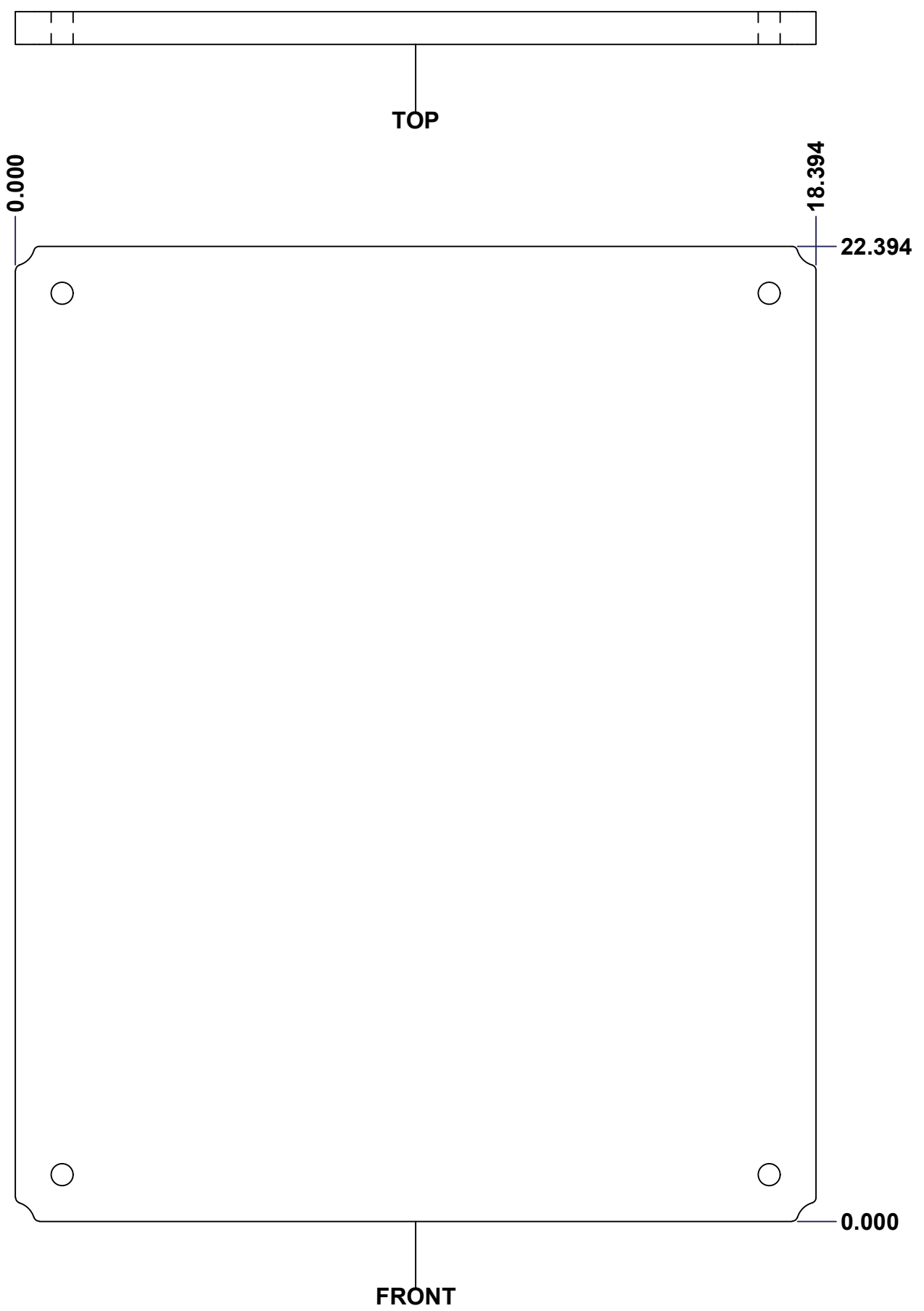

No.	Revisions	Date	By/Par

**Isometric View**

<p>Tél: (450) 979-4373                  Fax: (450) 979-4626  <a href="http://www.exmweb.com">www.exmweb.com</a></p>		Flatness Aplatissement
		Max 3.0mm
Projection		
Customer Client	Date	
Drawn By Dessiné Par	BoxCad: Patrick Deschenes	Date 23-Jan-07
Material Matière Polyisocyanurate		
Color Couleur	Aluminum	Finish Fini N/A
Description		Detail Rev.
5412ESSW 24" x 20" Back Insulation		
Part Number Numéro Pièce	Rev.	11
SEE BILL OF MATERIAL ON LAST PAGE 5412ESSW2420106THNOIPI-B 0		15

This drawing is confidential and must not be reproduced or used without the consent of EXM

Ce dessin est confidentiel et ne doit pas être reproduit ou utilisé sans le consentement de EXM

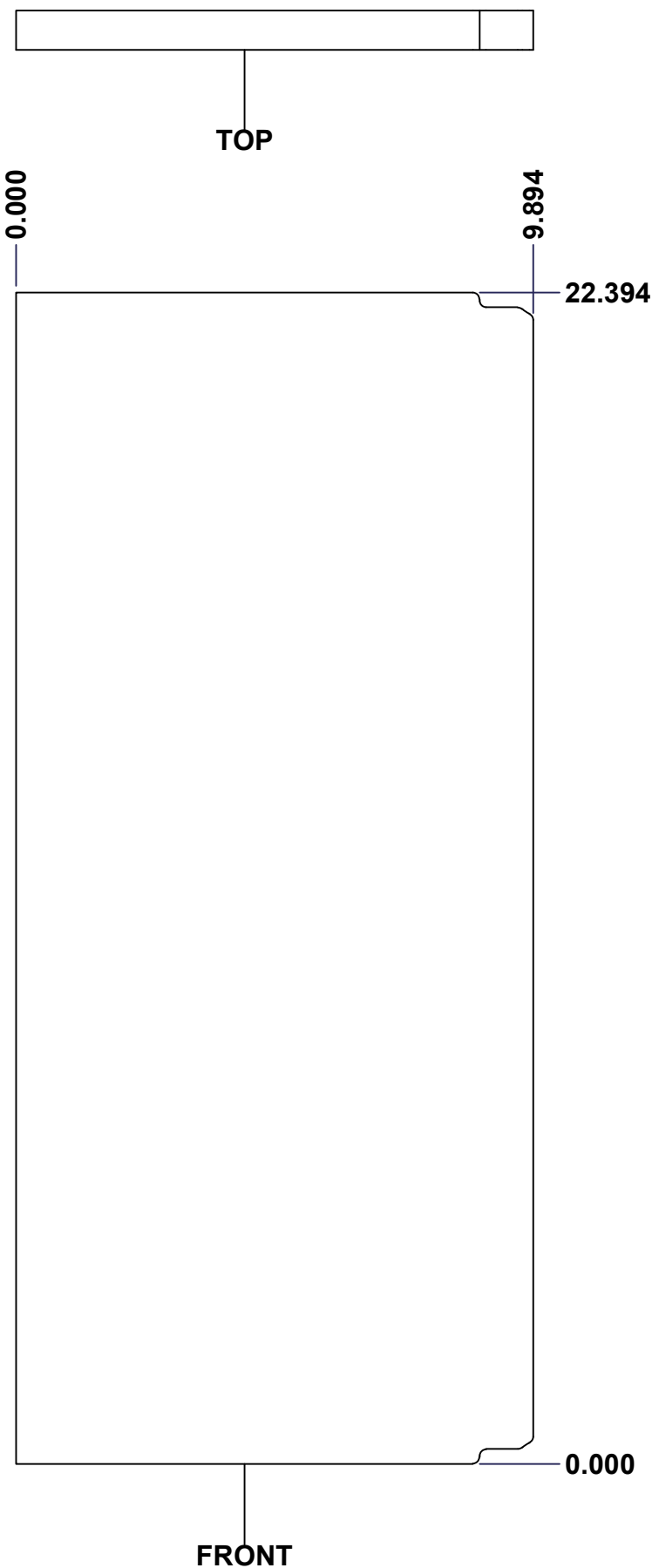

No.	Revisions	Date	By/Par

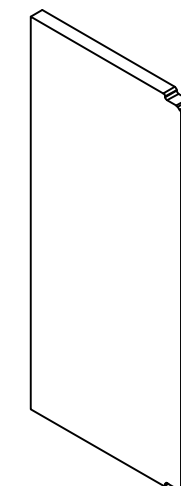

Isometric View

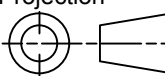

 Tél: (450) 979-4373 Fax: (450) 979-4626 <a href="http://www.exmweb.com">www.exmweb.com</a>		Flatness Aplatissement Max 3.0mm Projection 
Customer Client	Date	
Drawn By Dessiné Par	BoxCad: Patrick Deschenes	Date 23-Jan-07
Material Matière	Polyisocyanurate	
Color Couleur	Aluminum	Finish Fini N/A
Description	Detail Rev.	
5412ESSW 24" x 20" Left Insulation		
Part Number Numéro Pièce	Rev.	12
5412ESSW2420106THNOIP-L	S0	15

SEE BILL OF MATERIAL ON LAST PAGE

This drawing is confidential and must not be reproduced or used without the consent of EXM

Ce dessin est confidentiel et ne doit pas être reproduit ou utilisé sans le consentement de EXM

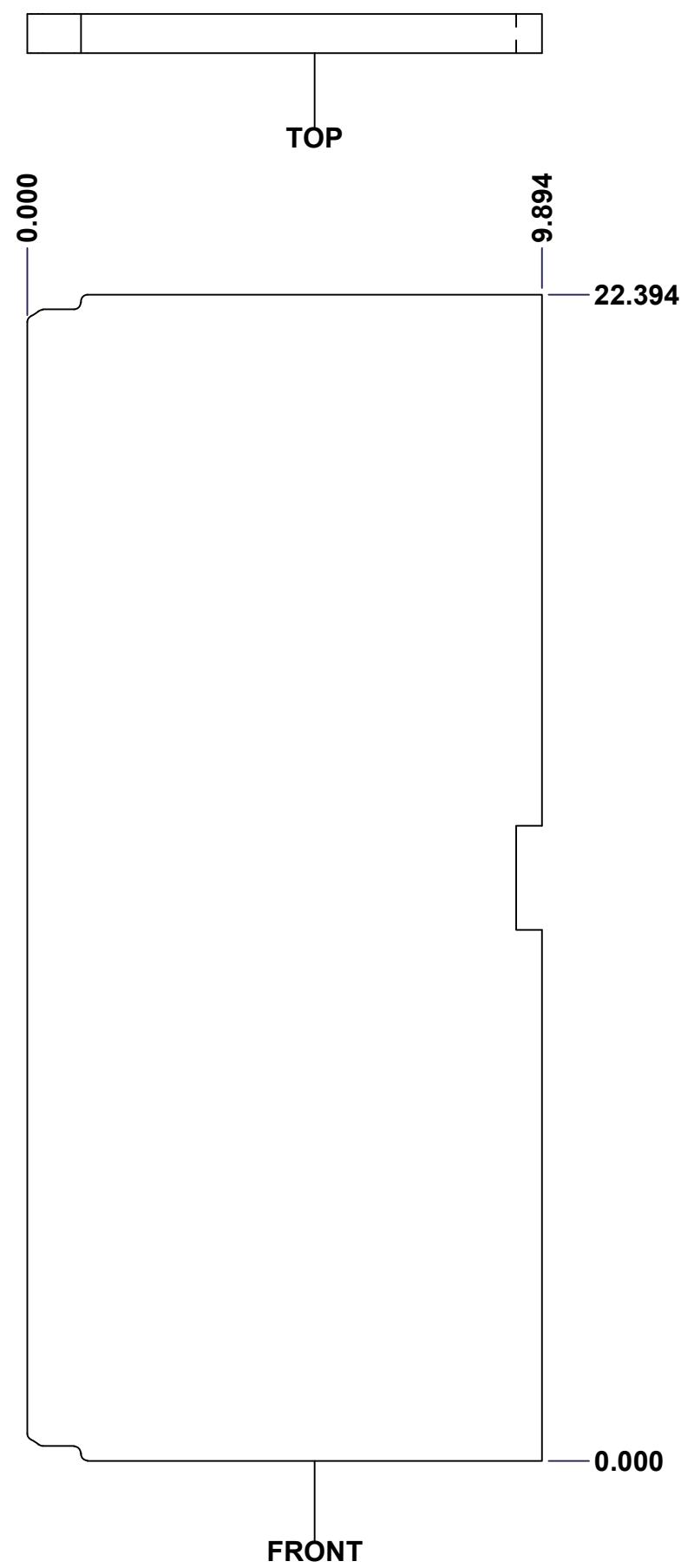

No.	Revisions	Date	By/Par

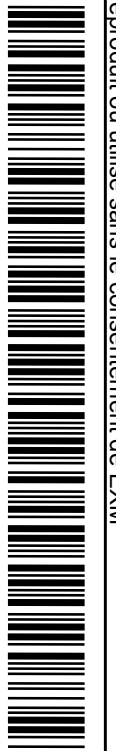
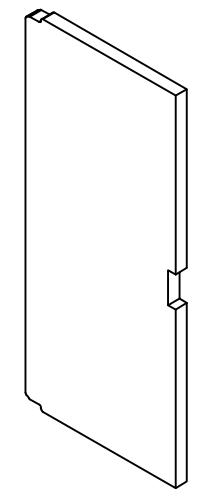

Isometric View

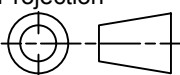
 Tél: (450) 979-4373 Fax: (450) 979-4626 <a href="http://www.exmweb.com">www.exmweb.com</a>		Flatness Aplatissement Max 3.0mm
Customer Client		Projection 
Drawn By / Dessiné Par: BoxCad: Patrick Deschenes		Date: 23-Jan-07
Material / Matière: Polyisocyanurate		
Color / Couleur: Aluminum	Finish / Fini: N/A	
Description: 5412ESSW 24" x 20" Right Insulation		Detail Rev.
Part Number / Numéro Pièce: 5412ESSW2420106THNOIP-RS0		Rev. 13

SEE BILL OF MATERIAL ON LAST PAGE 5412ESSW2420106THNOIP-RS0 15

This drawing is confidential and must not be reproduced or used without the consent of EXM

Ce dessin est confidentiel et ne doit pas être reproduit ou utilisé sans le consentement de EXM



TOP

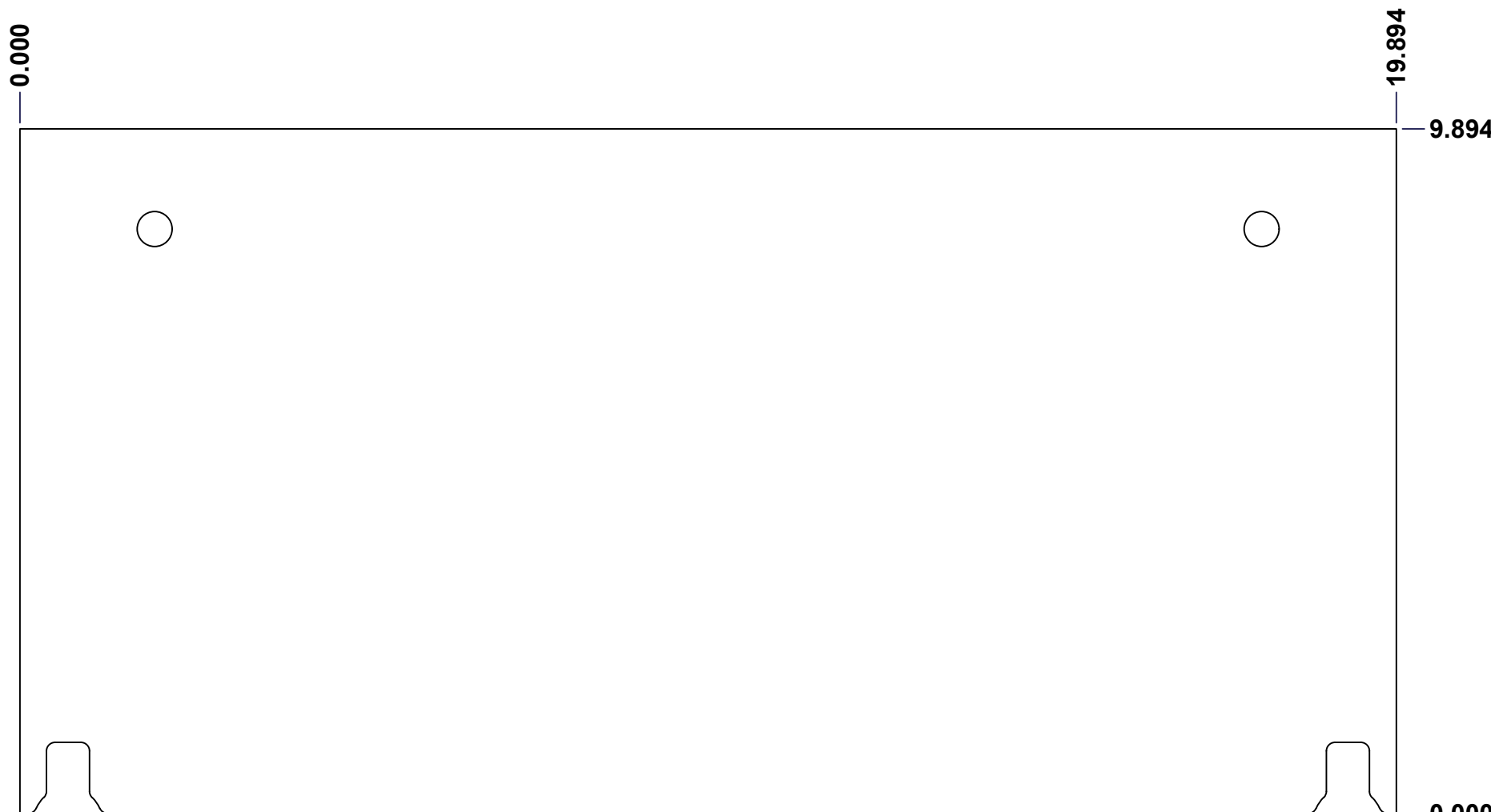

FRONT

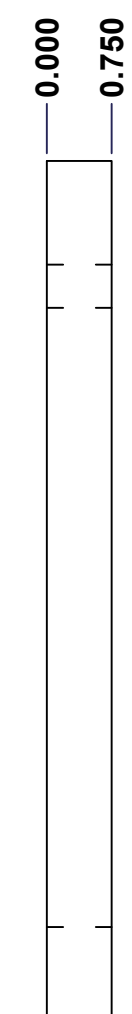

RIGHT

No.	Revisions	Date	By/Par

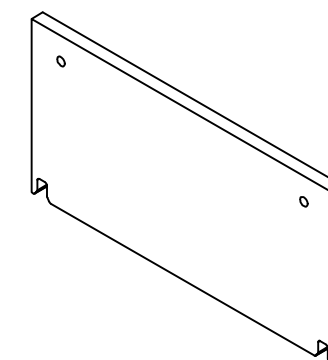

Isometric View



Tél: (450) 979-4373  
 Fax: (450) 979-4626  
[www.exmweb.com](http://www.exmweb.com)

Flatness  
Aplatissement  
Max 3.0mm  
Projection

Customer Client  
 Drawn By Dessiné Par BoxCad: Patrick Deschenes  
 Date 23-Jan-07

Material Matière Polyisocyanurate

Color Couleur Aluminum  
 Finish Fini N/A

Description 5412ESSW 24" x 20" Top and Bottom Insulation  
 Detail Rev.

Part Number Numéro Pièce  
 Rev. 14

SEE BILL OF MATERIAL ON LAST PAGE 5412ESSW2420106THNOIPI-TP0

This drawing is confidential and must not be reproduced or used without the consent of EXM

Ce dessin est confidentiel et ne doit pas être reproduit ou utilisé sans le consentement de EXM

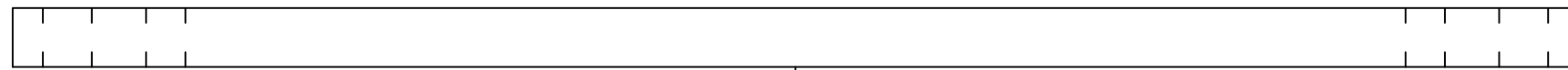

TOP



FRONT

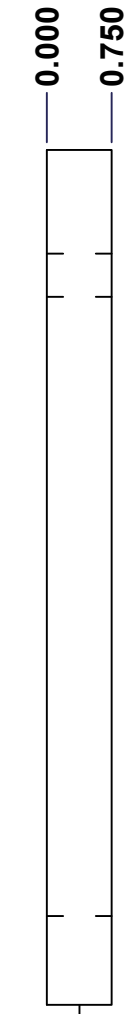

RIGHT

No.	Revisions	Date	By/Par

**Isometric View**

<p>Tél: (450) 979-4373 Fax: (450) 979-4626 <a href="http://www.exmweb.com">www.exmweb.com</a></p>		Flatness Aplatissement
		Max 3.0mm
		Projection
Customer Client	Date	Date
Drawn By Dessiné Par	BoxCad: Patrick Deschenes	Date 23-Jan-07
Material Matière	Polyisocyanurate	
Color Couleur	Aluminum	Finish Fini N/A
Description	Detail Rev.	
5412ESSW 24" x 20" Top and Bottom Insulation		
Part Number Numéro Pièce	Rev.	15
SEE BILL OF MATERIAL ON LAST PAGE		15