

This drawing is confidential and must not be reproduced or used without the consent of EXM

Ce dessin est confidentiel et ne doit pas être reproduit ou utilisé sans le consentement de EXM

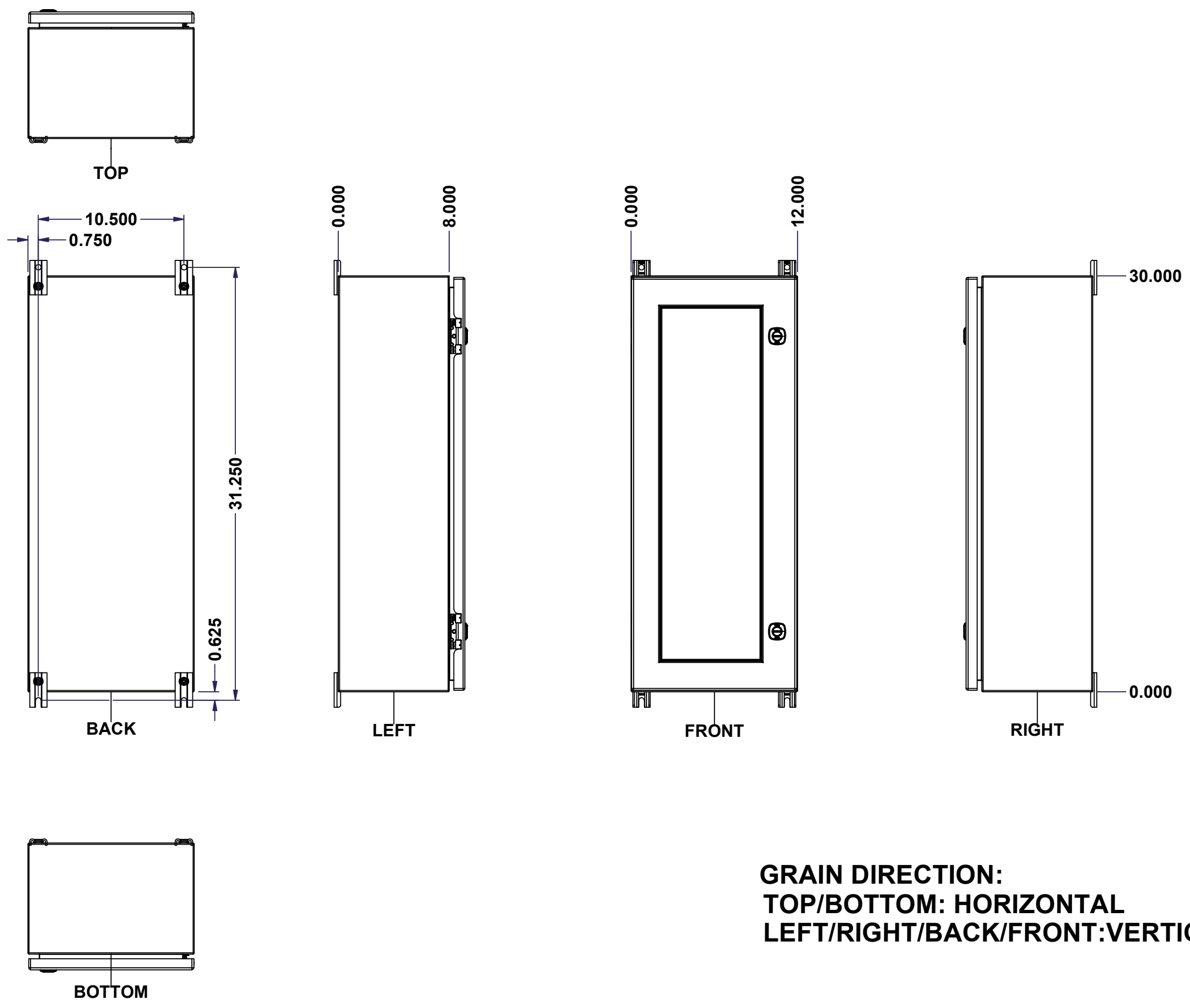

**GRAIN DIRECTION:
TOP/BOTTOM: HORIZONTAL
LEFT/RIGHT/BACK/Front: VERTICAL**

| No. | Revisions | Date | By/Par |
|-----|-----------|------|--------|
| | | | |
| | | | |
| | | | |
| | | | |
| | | | |

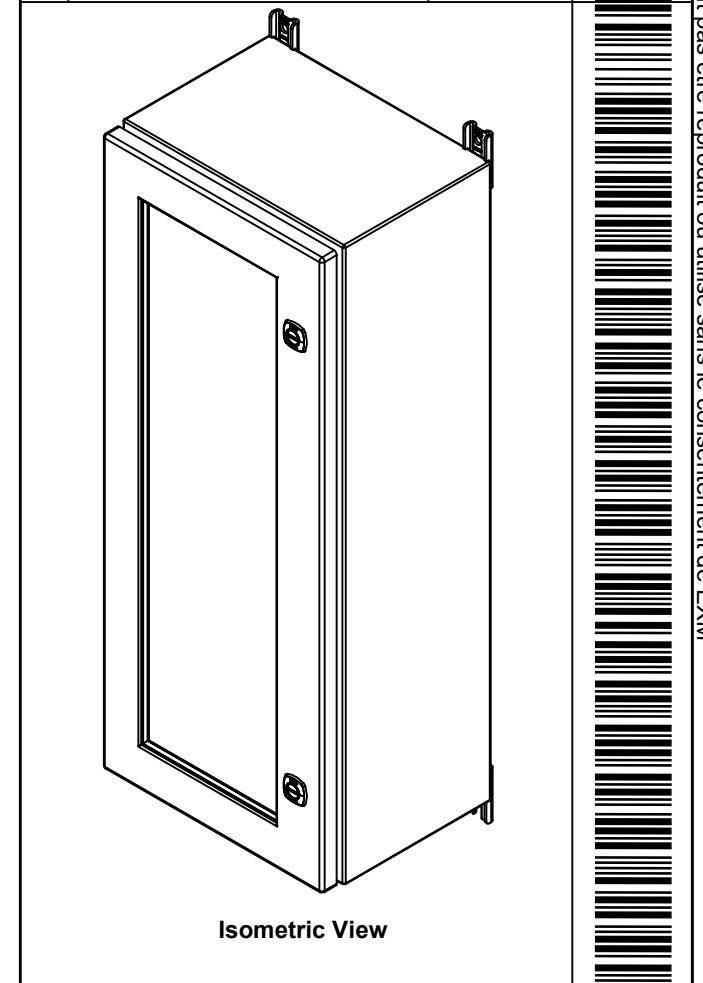

| | | |
|--|-----------------------------------|--|
| Tél: (450) 979-4373 Fax: (450) 979-4626 www.exmweb.com | | Flatness Aplatissement Max 3.0mm Projection |
| Customer Client | Date | |
| Drawn By Dessiné Par | BoxCad: BoxCad | Date 16-Jun-23 |
| Material Matière | 16 Ga Stainless Steel 316 (1.4mm) | |
| Color Couleur | Unpainted | Finish Fini Brushed |
| Description | Detail Rev. | |
| 5412ESSW 30" x 12" x 8" Assembly | | |
| Part Number Numéro Pièce | Rev. 0 | 1 15 |

SEE BILL OF MATERIAL ON LAST PAGE **5412ESSW3012086THNOIP**

This drawing is confidential and must not be reproduced or used without the consent of EXM

Ce dessin est confidentiel et ne doit pas être reproduit ou utilisé sans le consentement de EXM

| NOTE | |
|------|---|
| ITEM | DESCRIPTION |
| 1 | NEMA 4X Enclosure |
| 2 | C/W Standard ground studs on box and cover |
| 3 | W/O Standard door stiffener |
| 4 | W/O Inner panel |
| 5 | C/W Standard inner panel mounting studs |
| 6 | C/W 885 ESMF4_OPEN Sold separately (Installed) |
| 7 | C/W 885 ESMF4_CLOSE Sold separately (Installed) |
| 8 | C/W R5 Insulation (Installed by EXM) |

| No. | Revisions | Date | By/Par |
|-----|-----------|------|--------|
| | | | |
| | | | |
| | | | |
| | | | |
| | | | |
| | | | |
| | | | |

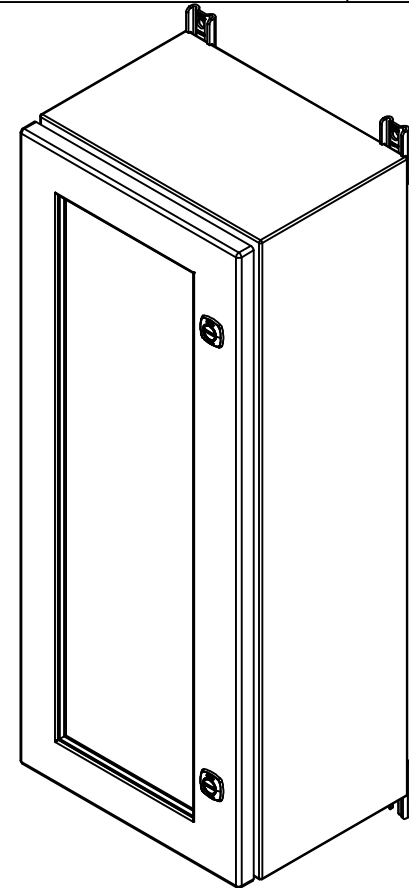

Isometric View



Tél: (450) 979-4373
 Fax: (450) 979-4626
www.exmweb.com

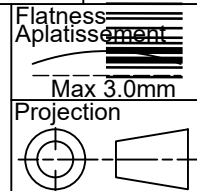

| | |
|--|-----------------|
| Customer Client | Date |
| Drawn By / Dessiné Par: BoxCad: BoxCad | Date: 16-Jun-23 |

Material / Matière: 16 Ga Stainless Steel 316 (1.4mm)

| | |
|----------------------------|------------------------|
| Color / Couleur: Unpainted | Finish / Fini: Brushed |
|----------------------------|------------------------|

Description: 5412ESSW 30" x 12" x 8" Assembly

| | | | |
|---|--------|---|----|
| Part Number / Numéro Pièce: 5412ESSW3012086THNOIP | Rev. 0 | 2 | 15 |
|---|--------|---|----|

| Qty | Part Number | Rev | Description |
|-----|-------------------------|-----|--|
| 4 | STK-Q-00600 | 2 | M12 to M8 Adaptor |
| 1 | STK-K-01800 | 5 | 5412 ES Accessory Kit |
| 1 | 5412ESSW3012086THNO IPC | 0 | 5412ESSW 30" x 12" Cover |
| 1 | 5412ESSW3012086THNO IPB | 0 | 5412ESSW 30" x 12" x 8" Body |
| 2 | STK-Q-04051-08 | 1 | M6 x 8mm Stainless Steel Hexagon Socket Head Machine Screw with Nyseal |

Parts List

| PACKING | | |
|-----------------------|-----|--|
| ITEM | QTY | DESCRIPTION |
| Cardboard sleeve | 2 | Top and Bottom |
| Cardboard strip | 2 | Between back of enclosure and inner panel |
| Plastic bag | 1 | To protect cover surface and inside gasket |
| Plastic strap - Black | 2 | To Squeeze the 2 cardboard sleeve together |
| Packaging label | 1 | White label with product number |

This drawing is confidential and must not be reproduced or used without the consent of EXM

Ce dessin est confidentiel et ne doit pas être reproduit ou utilisé sans le consentement de EXM

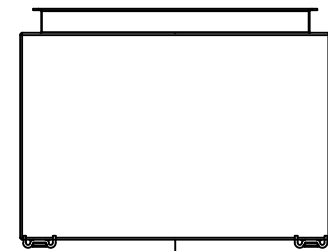

TOP

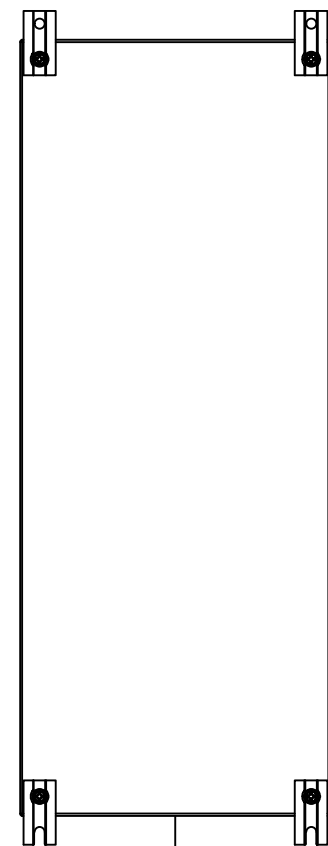

BACK

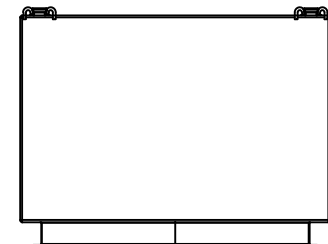

BOTTOM

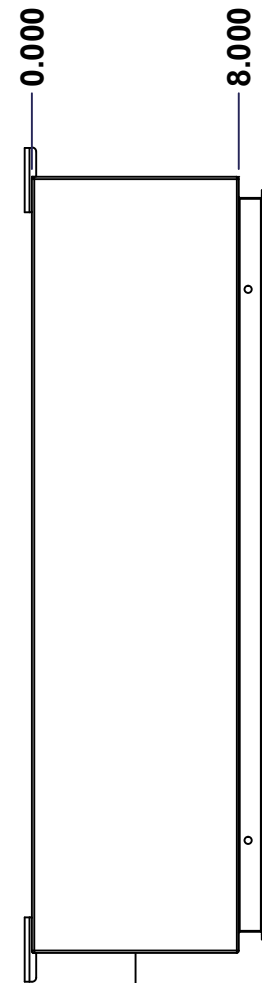

LEFT

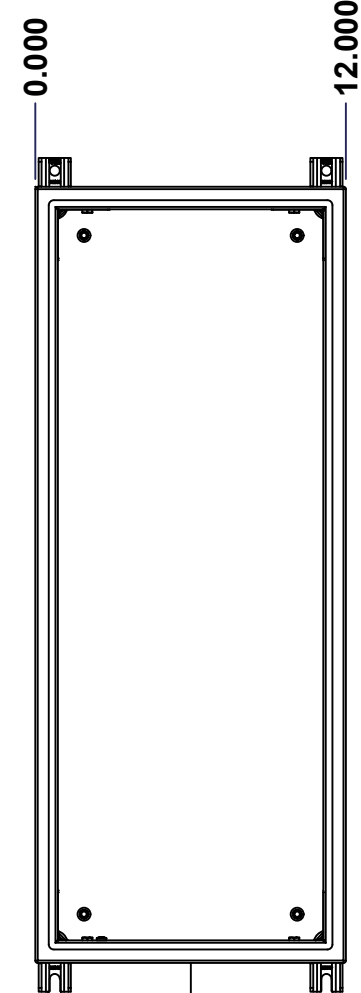

FRONT

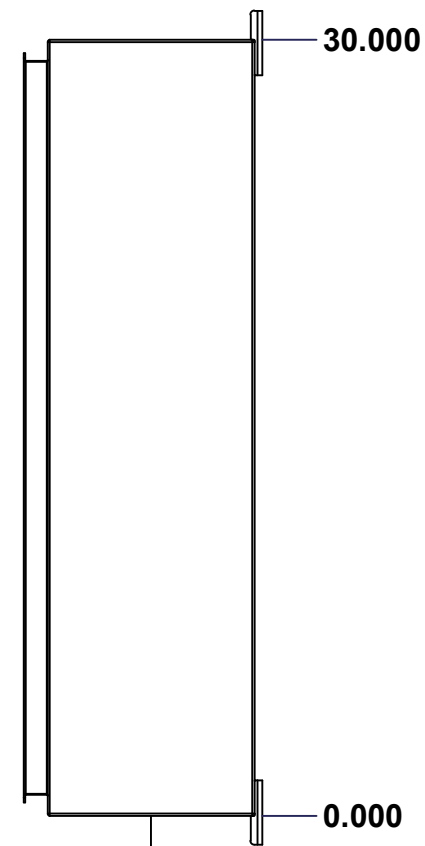

RIGHT

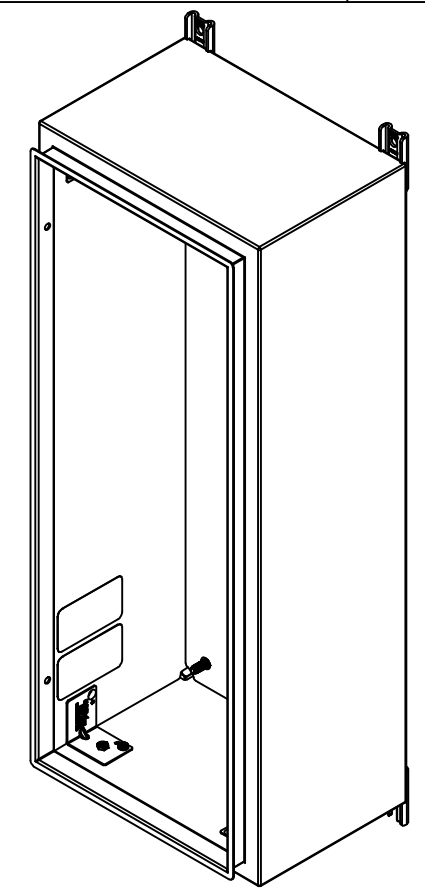

Isometric View



| No. | Revisions | Date | By/Par |
|-----|-----------|------|--------|
| | | | |
| | | | |
| | | | |
| | | | |

| | | |
|--|-----------------------------------|---|
|  Tél: (450) 979-4373 Fax: (450) 979-4626 www.exmweb.com | | Flatness Aplatissement  Max 3.0mm Projection  |
| Customer Client | Date | |
| Drawn By Dessiné Par | BoxCad: BoxCad | Date 16-Jun-23 |
| Material Matière | 16 Ga Stainless Steel 316 (1.4mm) | |
| Color Couleur | Unpainted | Finish Fini Brushed |
| Description | Detail Rev. | |
| 5412ESSW 30" x 12" x 8" Body | | |
| Part Number Numéro Pièce | Rev. 3 | 0 |

SEE BILL OF MATERIAL ON LAST PAGE 5412ESSW3012086THNOIPB 0 15

This drawing is confidential and must not be reproduced or used without the consent of EXM

Ce dessin est confidentiel et ne doit pas être reproduit ou utilisé sans le consentement de EXM

| STANDARD FEATURES ARE NOT LISTED IN THIS HOLE TABLE | | | |
|---|--------|-------|--------------------------------|
| HOLE TABLE - TOP VIEW (CUSTOM FEATURE ONLY) | | | |
| CUT-OUT | XDIM | YDIM | DESCRIPTION |
| 1 | 2.000 | 6.500 | INSUL. STUD M6 x 18mm (Inside) |
| 2 | 10.000 | 6.500 | INSUL. STUD M6 x 18mm (Inside) |

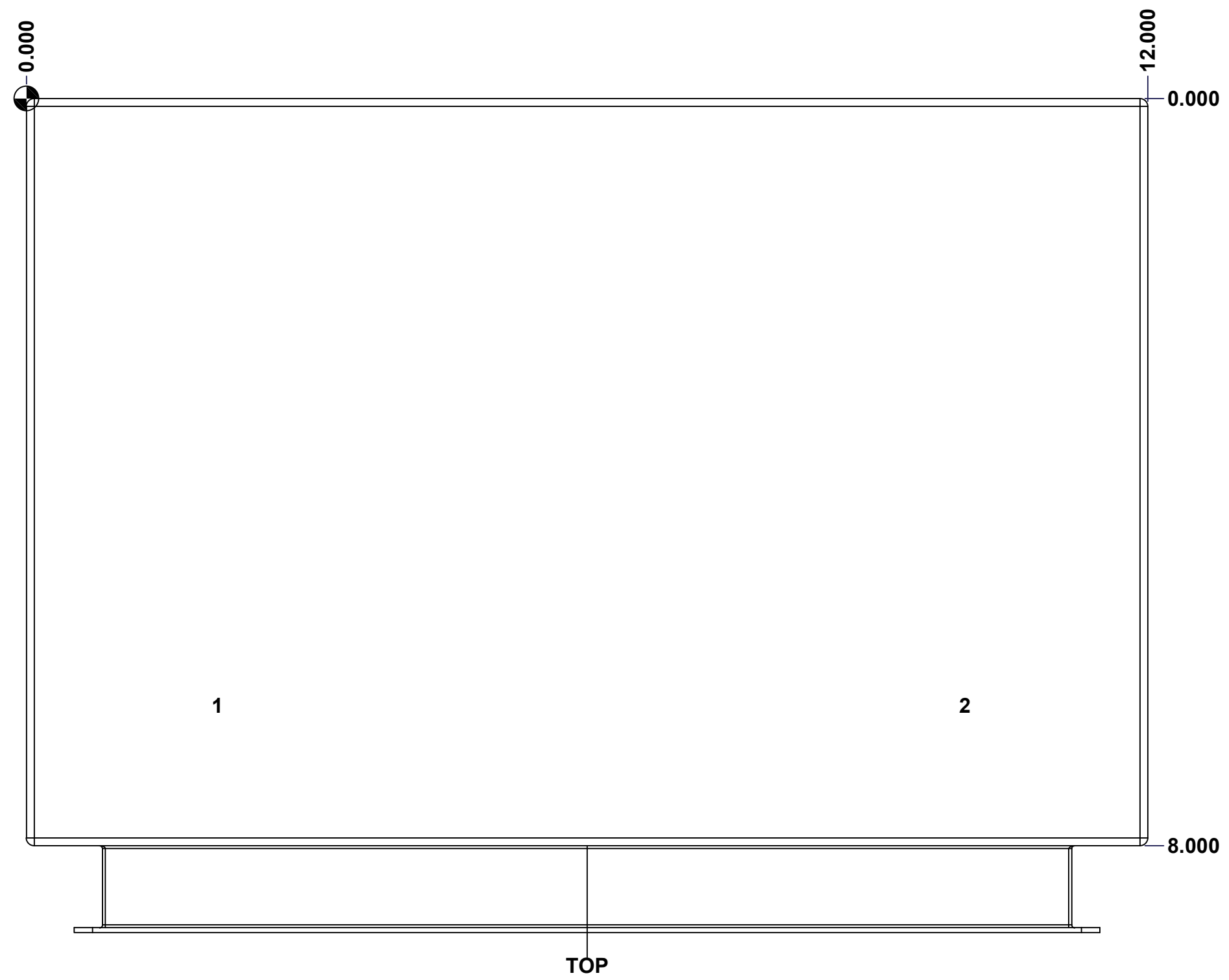

| | | |
|--|---------------------------------|--------|
| | Description | Status |
| | 5412ESSW 30" x 12" x 8" Body | (NULL) |
| | Part Number Numéro Pièce | Rev. |
| | 5412ESSW3012086THNOIPB 0 | 4 |
| | | 15 |

This drawing is confidential and must not be reproduced or used without the consent of EXM

Ce dessin est confidentiel et ne doit pas être reproduit ou utilisé sans le consentement de EXM

| STANDARD FEATURES ARE NOT LISTED IN THIS HOLE TABLE | | | |
|--|--------|-------|--------------------------------|
| HOLE TABLE - BOTTOM VIEW (CUSTOM FEATURE ONLY) | | | |
| CUT-OUT | XDIM | YDIM | DESCRIPTION |
| 1 | 2.000 | 6.500 | INSUL. STUD M6 x 18mm (Inside) |
| 2 | 10.000 | 6.500 | INSUL. STUD M6 x 18mm (Inside) |



| | | |
|--|---------------------------------|--------|
| | Description | Status |
| | 5412ESSW 30" x 12" x 8" Body | (NULL) |
| | Part Number Numéro Pièce | Rev. 5 |
| | 5412ESSW3012086THNOIPB 0 | 15 |

This drawing is confidential and must not be reproduced or used without the consent of EXM

Ce dessin est confidentiel et ne doit pas être reproduit ou utilisé sans le consentement de EXM

STANDARD FEATURES ARE NOT LISTED IN THIS HOLE TABLE

HOLE TABLE - BACK VIEW (CUSTOM FEATURE ONLY)

| CUT-OUT | XDIM | YDIM | DESCRIPTION |
|---------|--------|--------|----------------------------|
| 1 | 1.875 | 1.875 | IP STUD M8 x 35mm (Inside) |
| 2 | 1.875 | 28.125 | IP STUD M8 x 35mm (Inside) |
| 3 | 10.125 | 28.125 | IP STUD M8 x 35mm (Inside) |
| 4 | 10.125 | 1.875 | IP STUD M8 x 35mm (Inside) |
| ----- | | | |
| 5 | 11.250 | 0.000 | FOOT 885 ESMF4_OPEN |
| 6 | 0.750 | 0.000 | FOOT 885 ESMF4_OPEN |
| 7 | 11.250 | 30.000 | FOOT 885 ESMF4_CLOSE |
| 8 | 0.750 | 30.000 | FOOT 885 ESMF4_CLOSE |

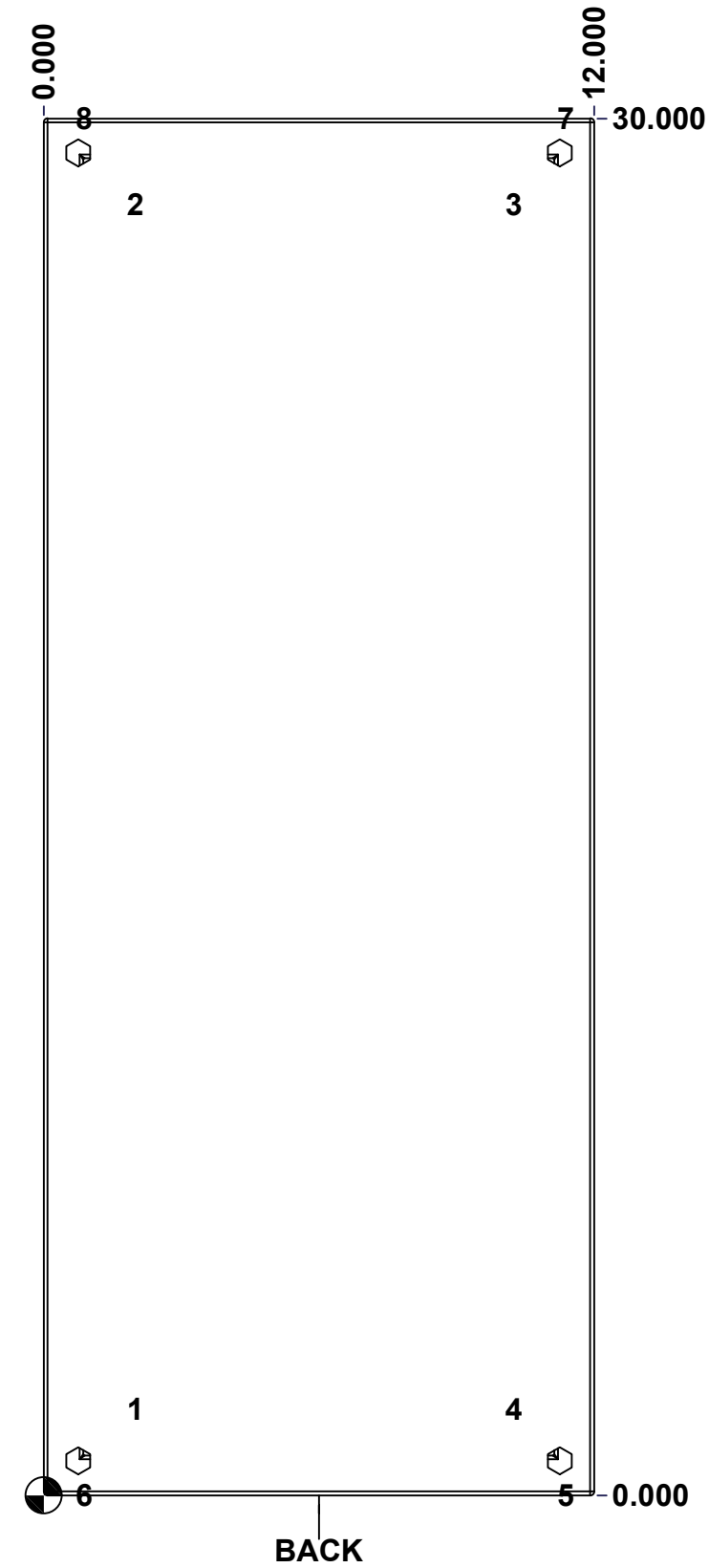

| | | |
|--|---------------------------------|--------|
| | Description | Status |
| | 5412ESSW 30" x 12" x 8" Body | (NULL) |
| | Part Number Numéro Pièce | Rev. |
| | 5412ESSW3012086THNOIPB 0 | 6 |
| | | 15 |

This drawing is confidential and must not be reproduced or used without the consent of EXM

Ce dessin est confidentiel et ne doit pas être reproduit ou utilisé sans le consentement de EXM

| No. | Revisions | Date | By/Par |
|-----|-----------|------|--------|
| | | | |
| | | | |
| | | | |
| | | | |
| | | | |

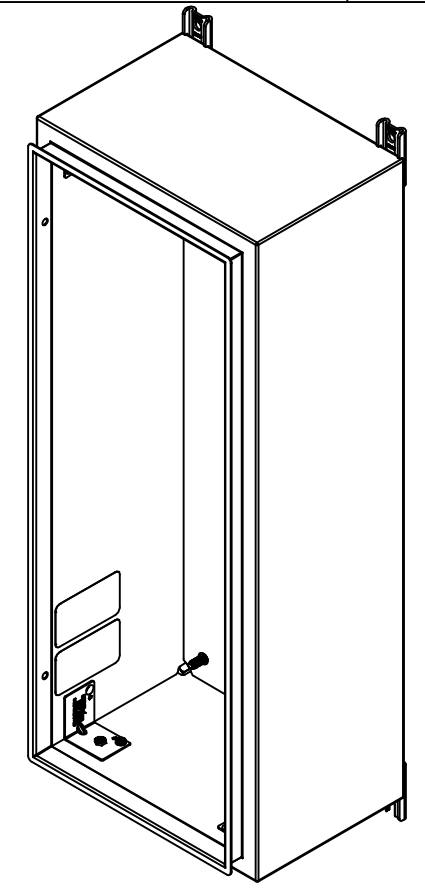

Isometric View

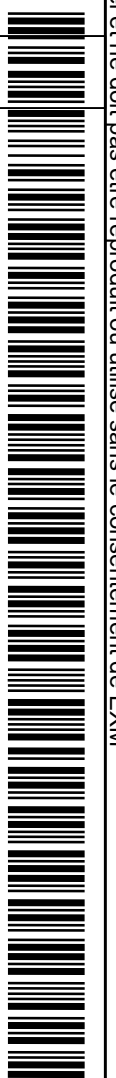

| | | | |
|---|----------------------------|---|---|
| 2 | 885ESMF4-FEET | 0 | 885 ESMF4 Stainless Steel Mounting Foot |
| 4 | RIVET_NUT_SS_M10_FH_CE | 0 | Stainless Steel Rivet Nut M10 (Low Profile Close End) |
| 4 | STK-Q-06670 | 2 | M10 x 16mm Stainless Steel Machine Screw |
| 2 | 885ESMF4-FEET-A | 0 | 885 ESMF4 Stainless Steel Mounting Foot (Opened Slot) |
| 2 | STK-S-00100 | 0 | 3.5" x 2" Silver Milar Flexcon Sticker |
| 1 | STK-K-70554 | 3 | 5412 ESTH Accessory Kit |
| 1 | 5412ESSW3012086THNO IPI-RS | 0 | 5412ESSW 30" x 12" Right Insulation |
| 1 | 5412ESSW3012086THNO IPI-LS | 0 | 5412ESSW 30" x 12" Left Insulation |
| 1 | 5412ESSW3012086THNO IPI-BT | 0 | 5412ESSW 30" x 12" Top and Bottom Insulation |
| 1 | 5412ESSW3012086THNO IPI-TP | 0 | 5412ESSW 30" x 12" Top and Bottom Insulation |
| 1 | 5412ESSW3012086THNO IPI-B | 0 | 5412ESSW 30" x 12" Back Insulation |
| 4 | STK-Q-16070 | 1 | Stud M6 x 18mm Stainless steel |
| 4 | STK-Q-16020 | 1 | Stud M8 x 35mm Stainless Steel |
| 1 | 5412ESSW3012086THNO IPB-P | 0 | 5412ESSW 30" x 12" x 8" Body Part |

| Qty | Part Number | Rev | Description |
|------------|-------------|-----|-------------|
| Parts List | | | |



Tél: (450) 979-4373
Fax: (450) 979-4626
www.exmweb.com

Flatness
Aplatissement
Max 5.0mm

Projection

Customer Client

Drawn By / Dessiné Par: BoxCad: BoxCad

Material / Matière: 16 Ga Stainless Steel 316 (1.4mm)

Color / Couleur: Unpainted

Finish / Fini: Brushed

Description: 5412ESSW 30" x 12" x 8" Body

Part Number / Numéro Pièce: 5412ESSW3012086THNOIPB 0

Date: 16-Jun-23

Rev. 7

This drawing is confidential and must not be reproduced or used without the consent of EXM

Ce dessin est confidentiel et ne doit pas être reproduit ou utilisé sans le consentement de EXM

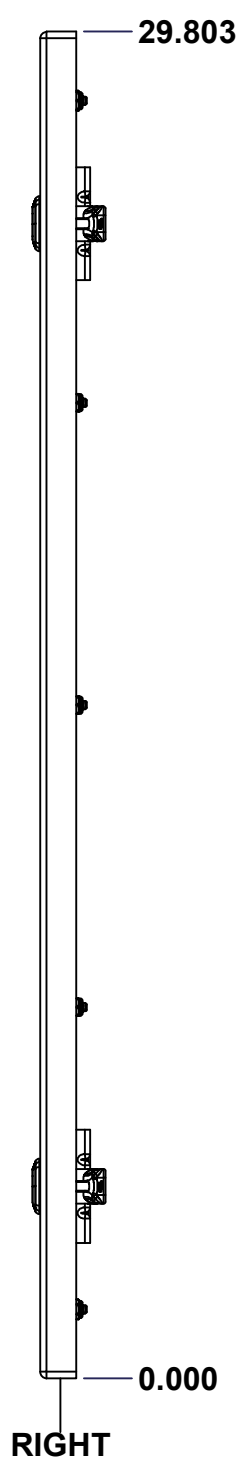
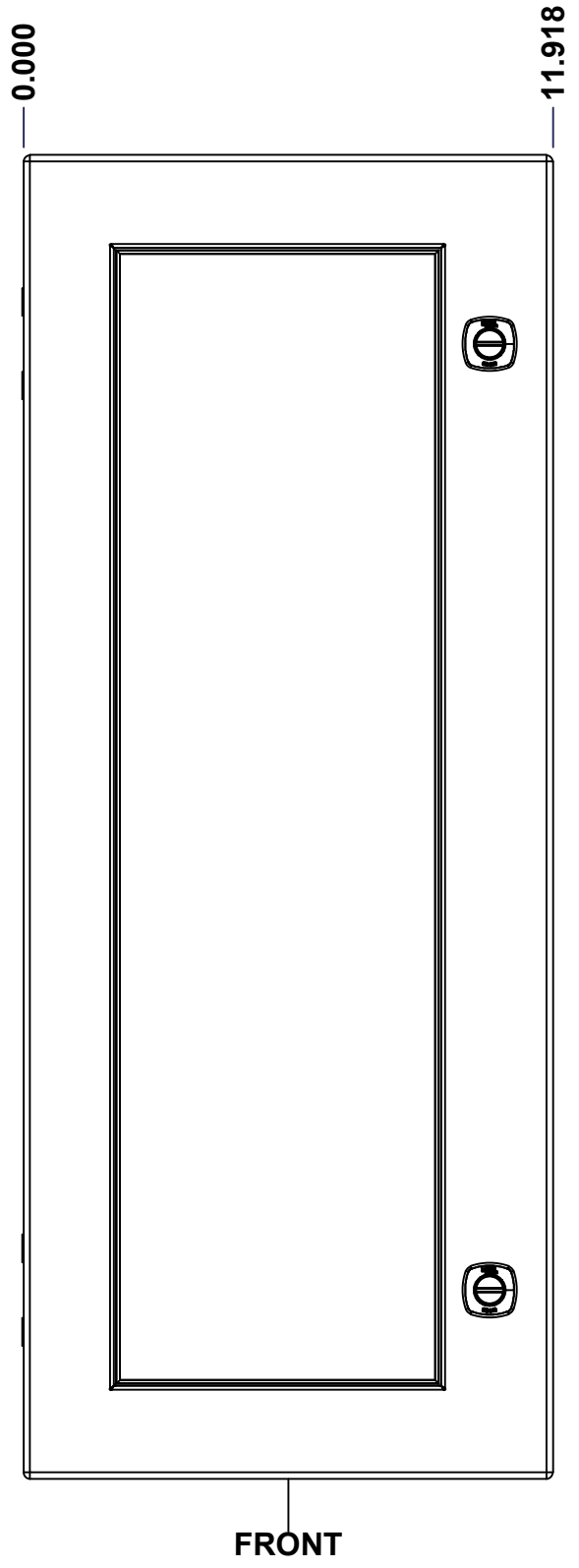
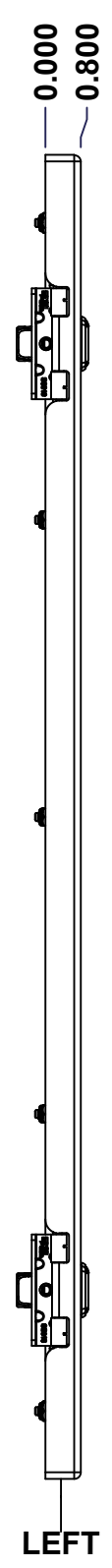
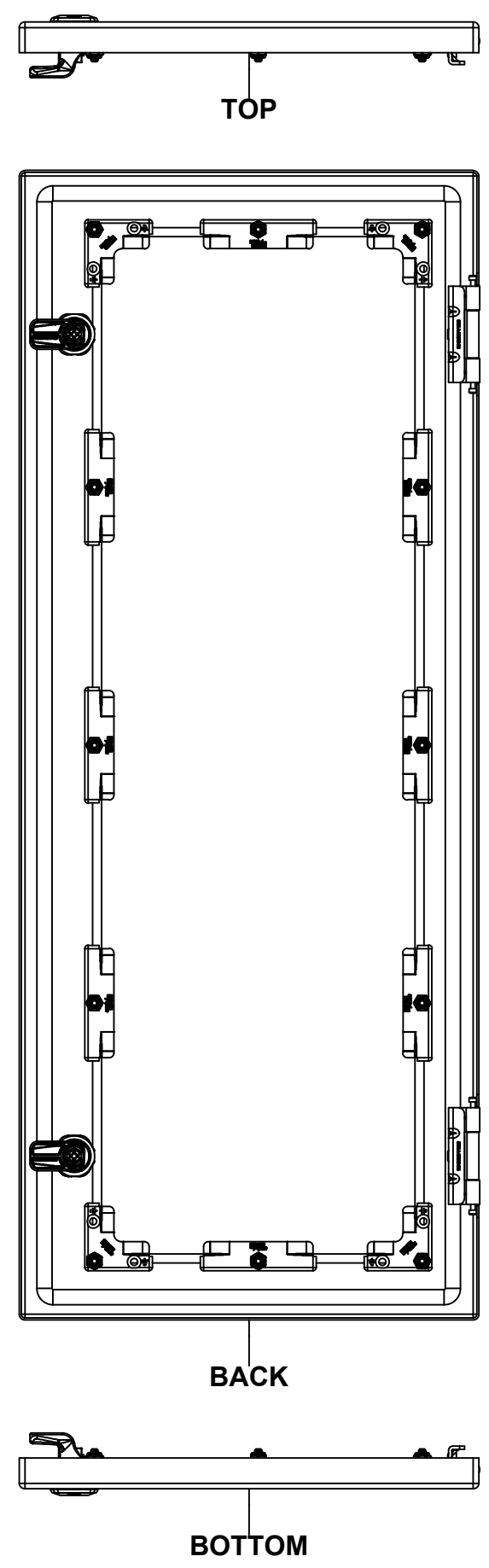

| No. | Revisions | Date | By/Par |
|-----|-----------|------|--------|
| | | | |
| | | | |
| | | | |
| | | | |

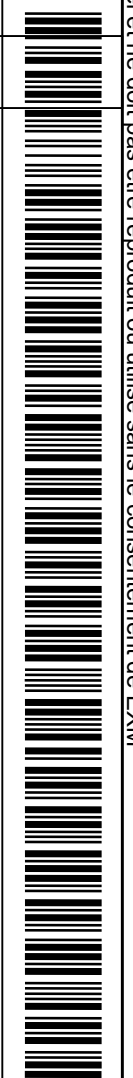
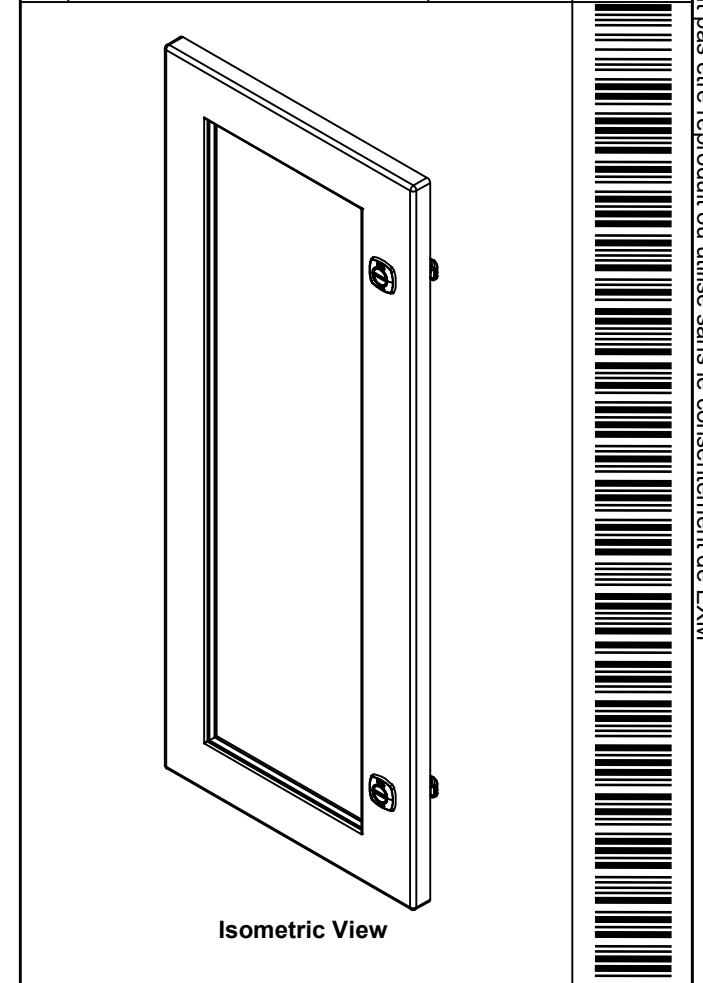

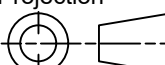
| | | |
|--|-----------------------------------|---|
|  Tél: (450) 979-4373 Fax: (450) 979-4626 www.exmweb.com | | Flatness Aplatissement  Max 5.0mm Projection  |
| Customer Client | Date | |
| Drawn By Dessiné Par | BoxCad: BoxCad | Date 16-Jun-23 |
| Material Matière | 16 Ga Stainless Steel 316 (1.4mm) | |
| Color Couleur | Unpainted | Finish Fini Brushed |
| Description | Detail Rev. | |
| 5412ESSW 30" x 12" Cover | | |
| Part Number Numéro Pièce | Rev. | 8 |
| | | 15 |

SEE BILL OF MATERIAL ON LAST PAGE 5412ESSW3012086THNOIPC 0

This drawing is confidential and must not be reproduced or used without the consent of EXM

Ce dessin est confidentiel et ne doit pas être reproduit ou utilisé sans le consentement de EXM

STANDARD FEATURES ARE NOT LISTED IN THIS HOLE TABLE

HOLE TABLE - FRONT VIEW (CUSTOM FEATURE ONLY)

| CUT-OUT | XDIM | YDIM | DESCRIPTION |
|---------|--------|--------|-------------------------|
| 1 | 1.469 | 8.214 | STUD M6 x 18mm (Inside) |
| 2 | 9.968 | 8.214 | STUD M6 x 18mm (Inside) |
| 3 | 1.469 | 14.902 | STUD M6 x 18mm (Inside) |
| 4 | 9.968 | 14.902 | STUD M6 x 18mm (Inside) |
| 5 | 1.469 | 21.589 | STUD M6 x 18mm (Inside) |
| 6 | 9.968 | 21.589 | STUD M6 x 18mm (Inside) |
| 7 | 1.469 | 28.276 | STUD M6 x 18mm (Inside) |
| 8 | 1.469 | 1.527 | STUD M6 x 18mm (Inside) |
| 9 | 5.719 | 28.276 | STUD M6 x 18mm (Inside) |
| 10 | 5.719 | 1.527 | STUD M6 x 18mm (Inside) |
| 11 | 9.968 | 28.276 | STUD M6 x 18mm (Inside) |
| 12 | 9.968 | 1.527 | STUD M6 x 18mm (Inside) |
| ----- | | | |
| 13 | 10.494 | 25.553 | 880 SCQ4-SLSS6 |
| 14 | 10.494 | 4.250 | 880 SCQ4-SLSS6 |

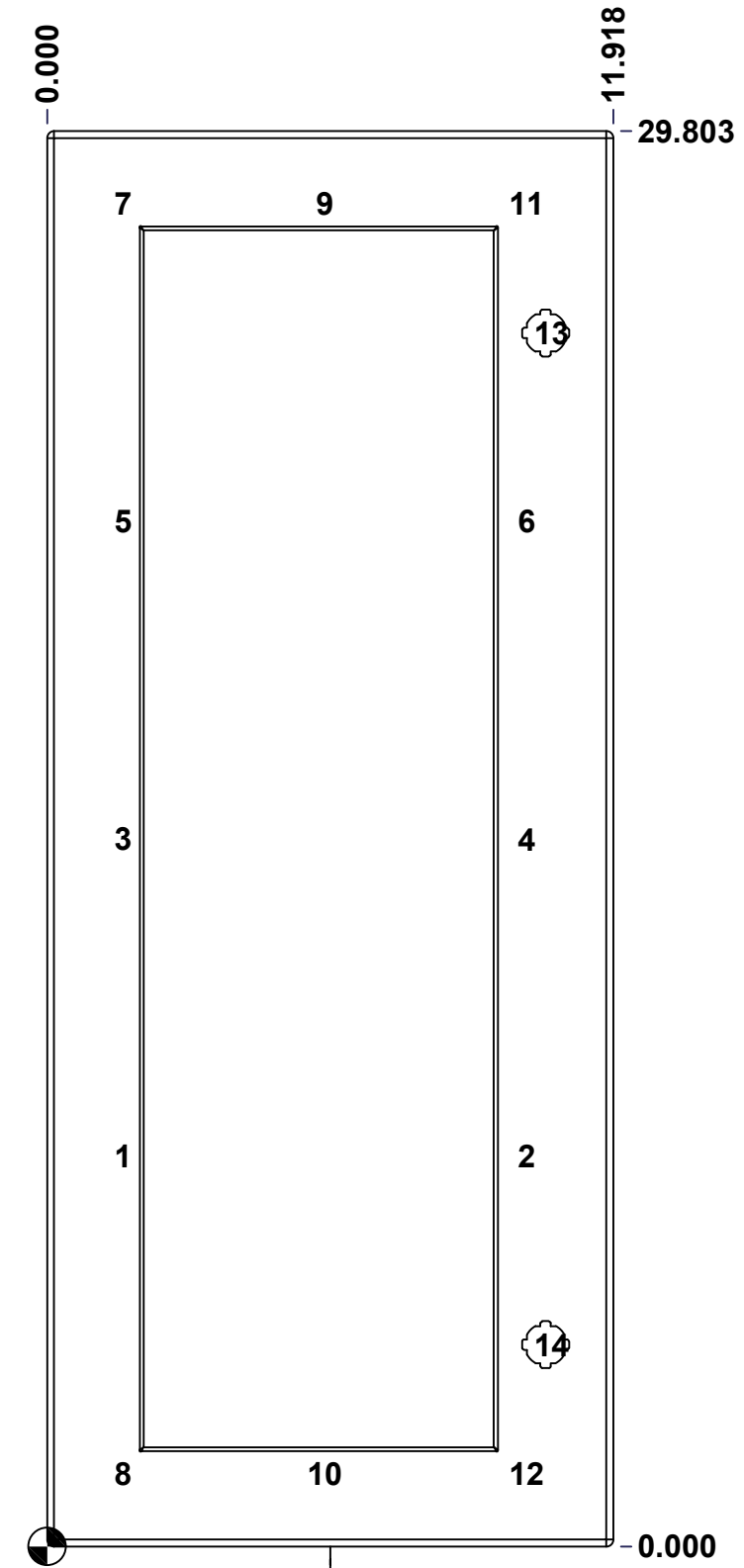

FRONT

| | | |
|--|-------------------------------|--------|
| | Description | Status |
| | 5412ESSW 30" x 12" Cover | (NULL) |
| | Part Number Numéro Pièce | Rev. |
| | 5412ESSW3012086THNOIPC | 9 |
| | 0 | 15 |

This drawing is confidential and must not be reproduced or used without the consent of EXM

Ce dessin est confidentiel et ne doit pas être reproduit ou utilisé sans le consentement de EXM

| No. | Revisions | Date | By/Par |
|-----|-----------|------|--------|
| | | | |
| | | | |
| | | | |
| | | | |
| | | | |

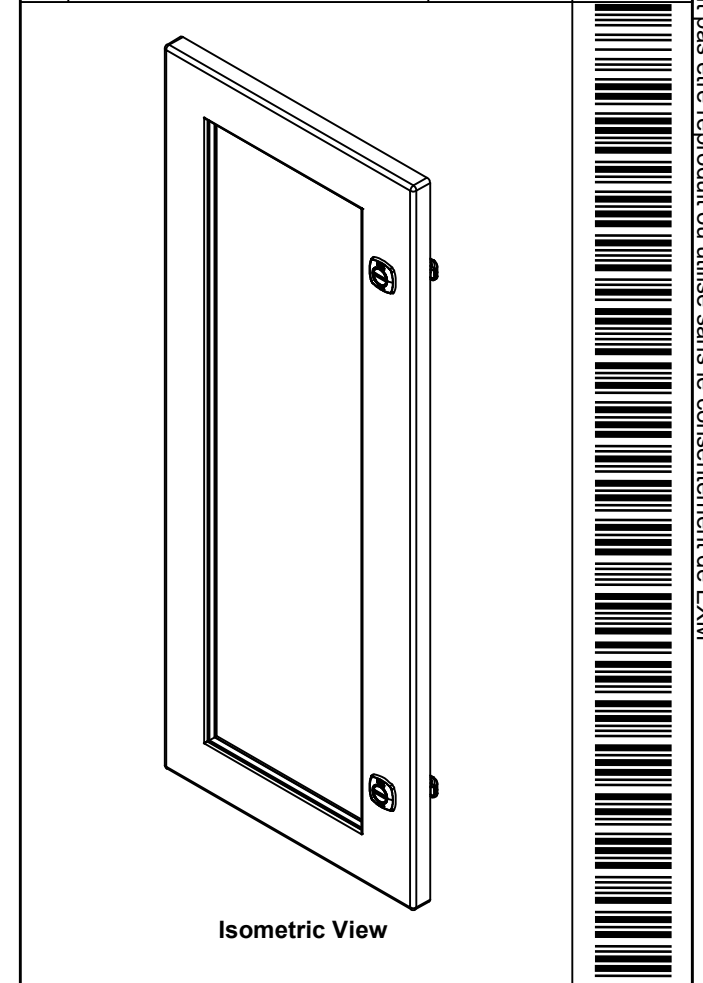

| QTY | Part Number | Rev | Description |
|-----|------------------------------|-----|--------------------------------------|
| 8 | STK-Q-60701 | 2.1 | 880 WK - Lexan 1/4" Fixing Bracket |
| 1 | STK-A-60703 | 0 | 5412 ESW Lexan Bracket Kit |
| 12 | STK-Q-16053 | 1 | Stud M6 x 23mm Stainless steel |
| 1 | STK-G-02710 | 0 | 880 HWKG - Windows Kit Gasket |
| 1 | 5412ESSW3012086THNO IPLXG | 0 | 5412ESSW 30" x 12" Lexan Gasket Part |
| 1 | 5412ESSW3012086THNO IPLX | 0 | 5412ESSW 26.375" x 8.125" Lexan Part |
| 1 | 5412ESSW3012086THNO IPG | 0 | 5412ESSW 30" x 12" Cover Gasket Part |
| 1 | 5412ESSW3012086THNO IPC-P | 0 | 5412ESSW 30" x 12" Cover Part |
| 2 | 880 SCQ4-SLSS6 | 7 | 5412 ESS 1/4 Turn Lock |
| 2 | STK-A-33016 | 0 | 5412 ESS Bended Hinge (Body Part) |
| | | | |
| | | | |

Tél: (450) 979-4373
Fax: (450) 979-4626
www.exmweb.com

Flatness
Aplatissement
Max 5.0mm

Projection

Customer Client

Drawn By / Dessiné Par: BoxCad: BoxCad

Material / Matière: 16 Ga Stainless Steel 316 (1.4mm)

Color / Couleur: Unpainted

Finish / Fini: Brushed

Description: 5412ESSW 30" x 12" Cover

Part Number / Numéro Pièce: **5412ESSW3012086THNOIPC**

Rev. 10

This drawing is confidential and must not be reproduced or used without the consent of EXM

Ce dessin est confidentiel et ne doit pas être reproduit ou utilisé sans le consentement de EXM

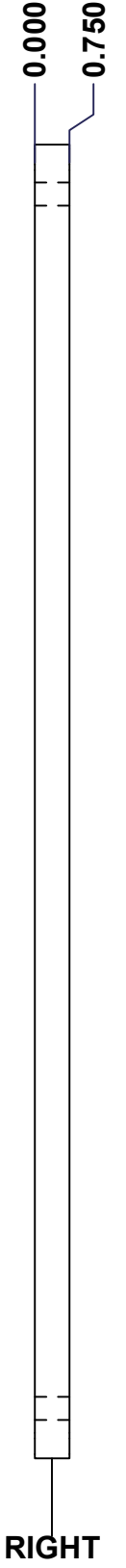
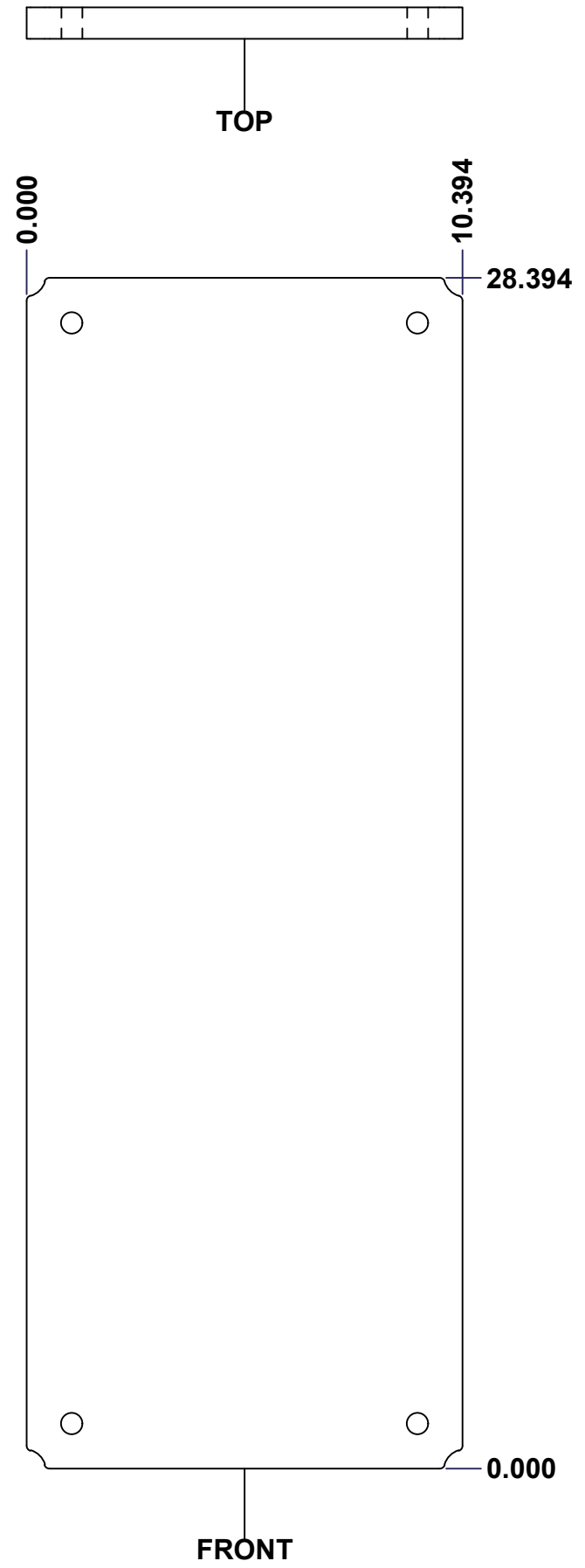

| No. | Revisions | Date | By/Par |
|-----|-----------|------|--------|
| | | | |
| | | | |
| | | | |
| | | | |
| | | | |

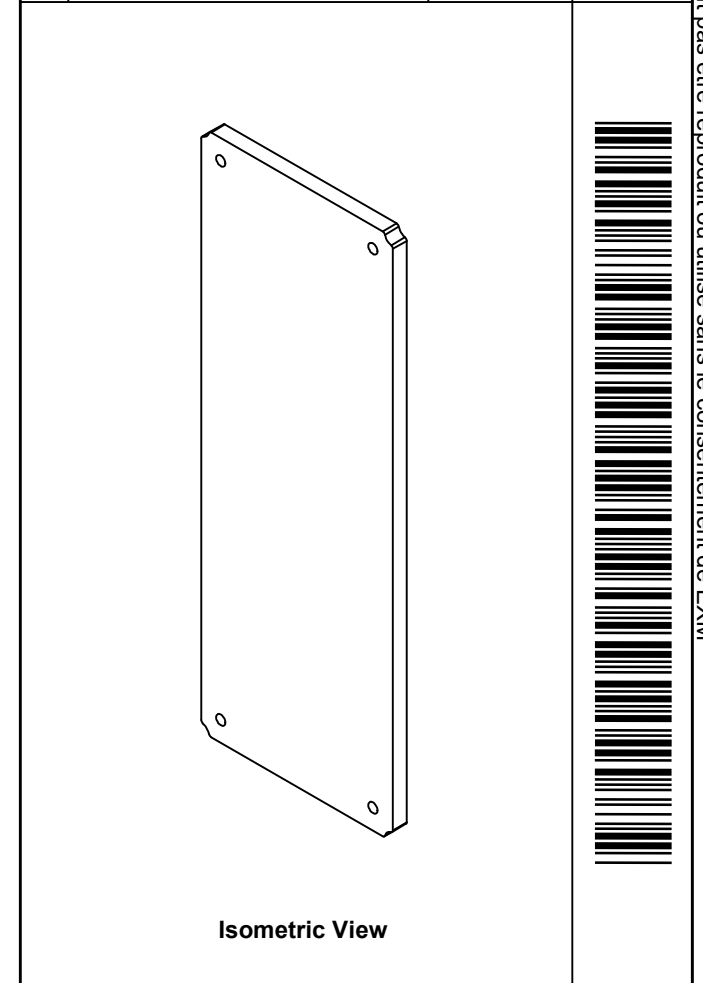

| | | |
|--|--------------------|--|
|  Tél: (450) 979-4373 Fax: (450) 979-4626 www.exmweb.com | | Flatness Aplatissement Max 3.0mm |
| Customer Client | | Date |
| Drawn By / Dessiné Par: BoxCad: Patrick Deschenes | | Date: 23-Jan-07 |
| Material / Matière: Polyisocyanurate | | |
| Color / Couleur: Aluminum | Finish / Fini: N/A | |
| Description: 5412ESSW 30" x 12" Back Insulation | | Detail Rev. |
| Part Number / Numéro Pièce: 5412ESSW3012086THNOIP-B 0 | | Rev. 11 |

SEE BILL OF MATERIAL ON LAST PAGE 5412ESSW3012086THNOIP-B 0 15

This drawing is confidential and must not be reproduced or used without the consent of EXM

Ce dessin est confidentiel et ne doit pas être reproduit ou utilisé sans le consentement de EXM

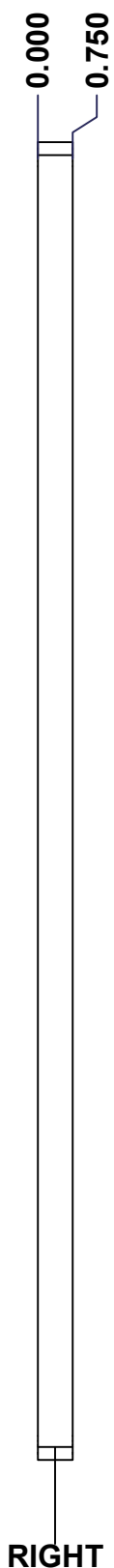
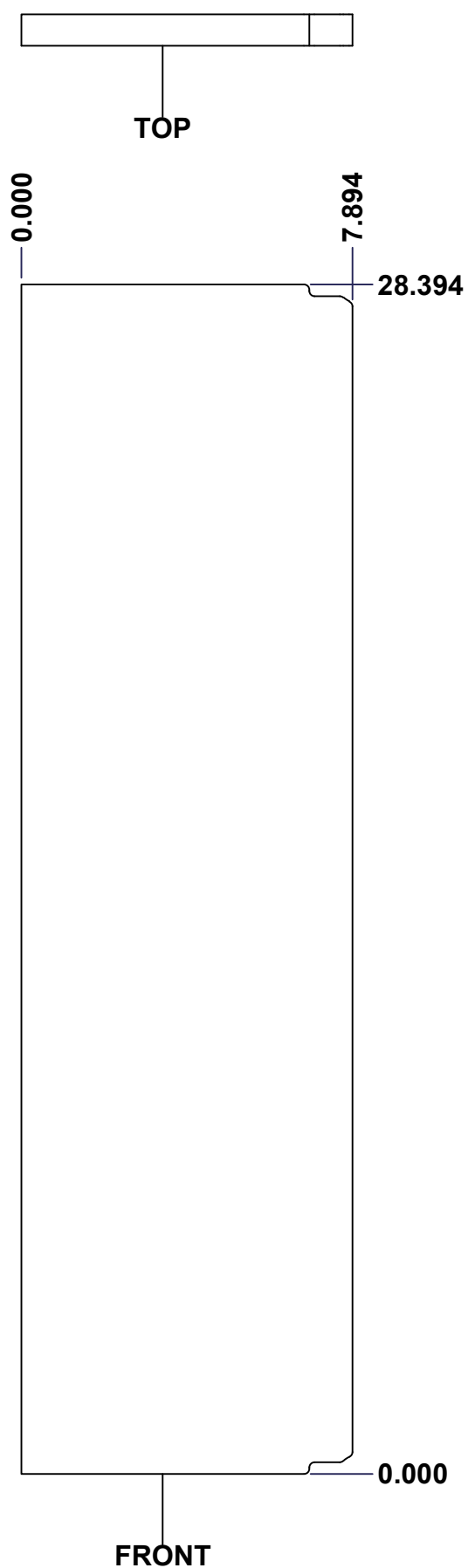

| No. | Revisions | Date | By/Par |
|-----|-----------|------|--------|
| | | | |
| | | | |
| | | | |
| | | | |
| | | | |

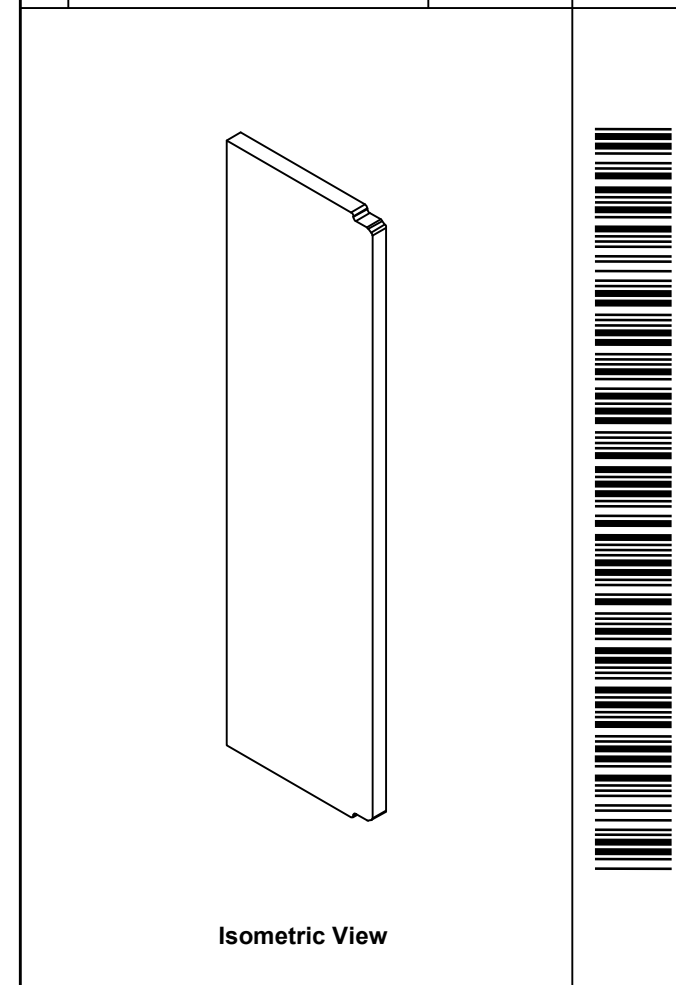

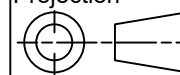
| | | |
|--|--------------------|--|
|  Tél: (450) 979-4373 Fax: (450) 979-4626 www.exmweb.com | | Flatness Aplatissement Max 3.0mm |
| Projection  | | Date 23-Jan-07 |
| Customer Client | Date | |
| Drawn By / Dessiné Par: BoxCad: Patrick Deschenes | Date: 23-Jan-07 | |
| Material / Matière: Polyisocyanurate | | |
| Color / Couleur: Aluminum | Finish / Fini: N/A | |
| Description: 5412ESSW 30" x 12" Left Insulation | Detail Rev. | |
| Part Number / Numéro Pièce: 5412ESSW3012086THNOIP-L | Rev.: | 12 |
| SEE BILL OF MATERIAL ON LAST PAGE | | 15 |

SEE BILL OF MATERIAL ON LAST PAGE 5412ESSW3012086THNOIP-L S0

This drawing is confidential and must not be reproduced or used without the consent of EXM

Ce dessin est confidentiel et ne doit pas être reproduit ou utilisé sans le consentement de EXM

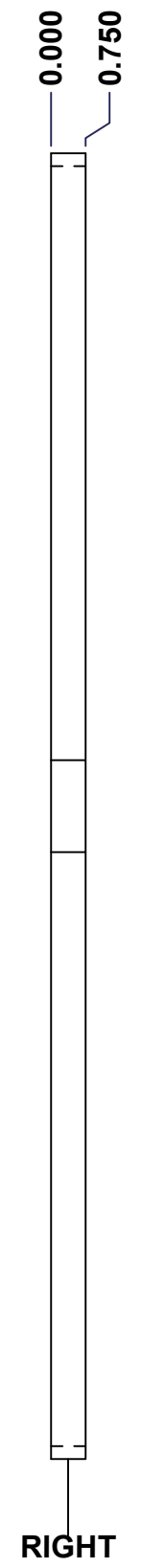
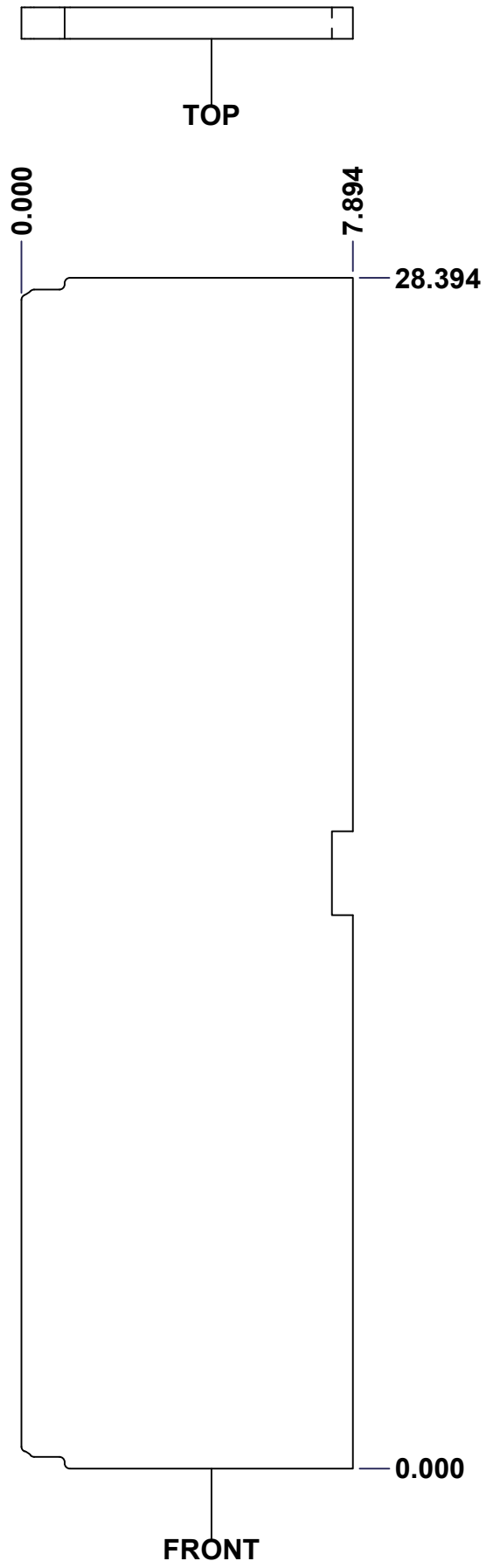

| No. | Revisions | Date | By/Par |
|-----|-----------|------|--------|
| | | | |
| | | | |
| | | | |
| | | | |
| | | | |

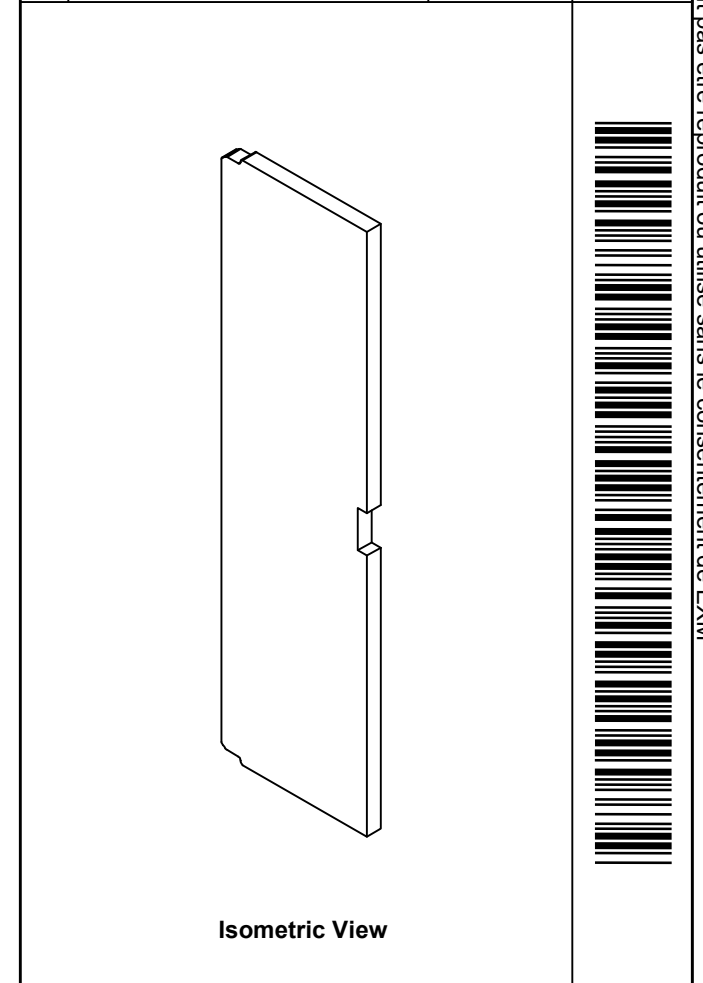

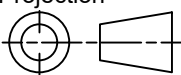
| | | |
|--|--------------------|--|
|  Tél: (450) 979-4373 Fax: (450) 979-4626 www.exmweb.com | | Flatness Aplatissement Max 3.0mm |
| Projection  | | Date 23-Jan-07 |
| Customer Client | Date | |
| Drawn By / Dessiné Par: BoxCad: Patrick Deschenes | Date: 23-Jan-07 | |
| Material / Matière: Polyisocyanurate | | |
| Color / Couleur: Aluminum | Finish / Fini: N/A | |
| Description: 5412ESSW 30" x 12" Right Insulation | Detail Rev. | |
| Part Number / Numéro Pièce: 5412ESSW3012086THNOIP-RS0 | Rev.: | 13 |

SEE BILL OF MATERIAL ON LAST PAGE 5412ESSW3012086THNOIP-RS0 15

This drawing is confidential and must not be reproduced or used without the consent of EXM

Ce dessin est confidentiel et ne doit pas être reproduit ou utilisé sans le consentement de EXM

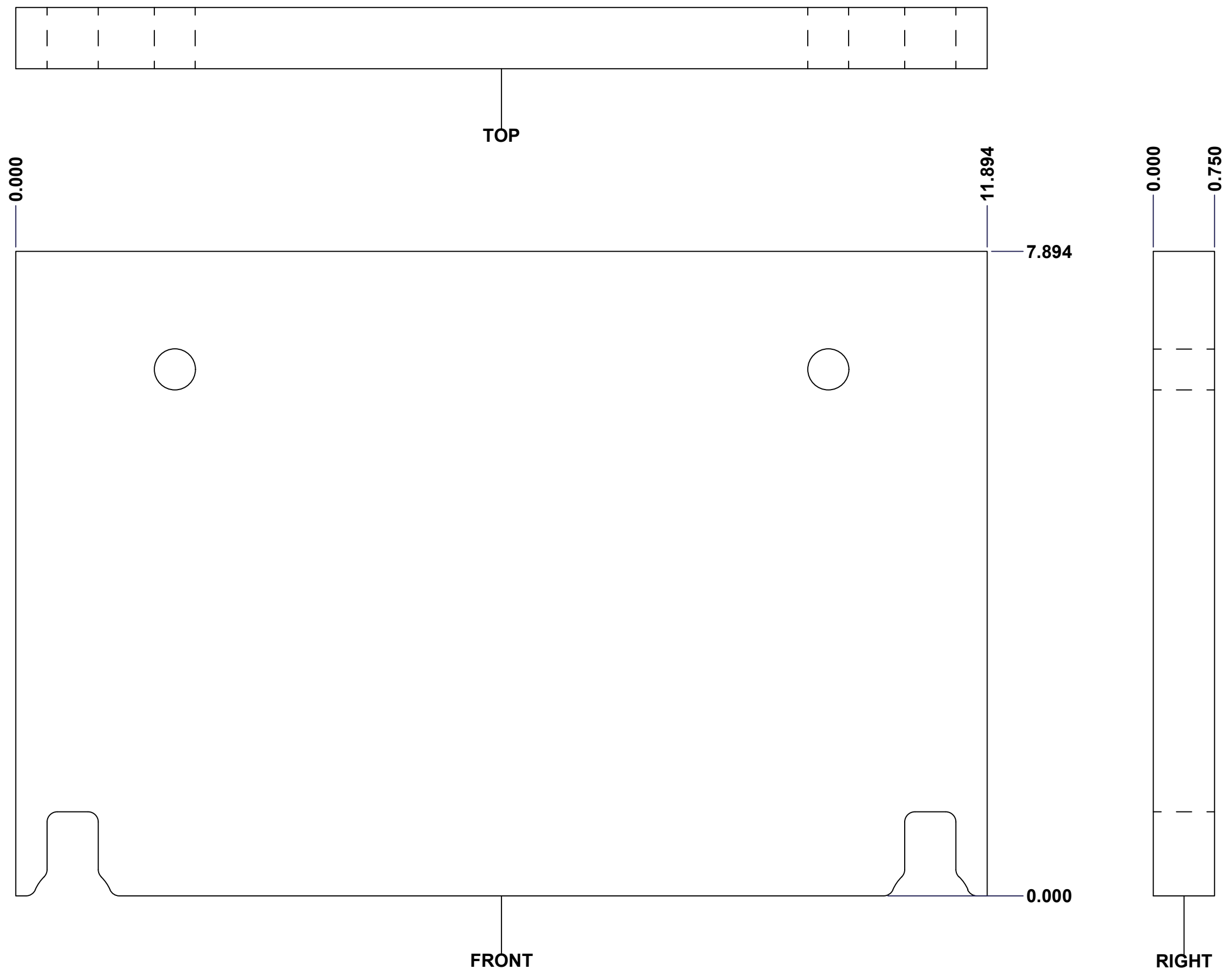

| No. | Revisions | Date | By/Par |
|-----|-----------|------|--------|
| | | | |
| | | | |
| | | | |
| | | | |
| | | | |

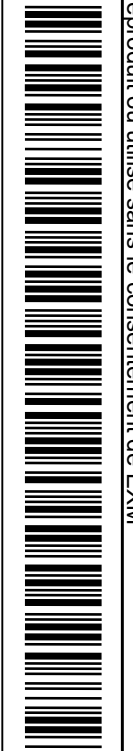
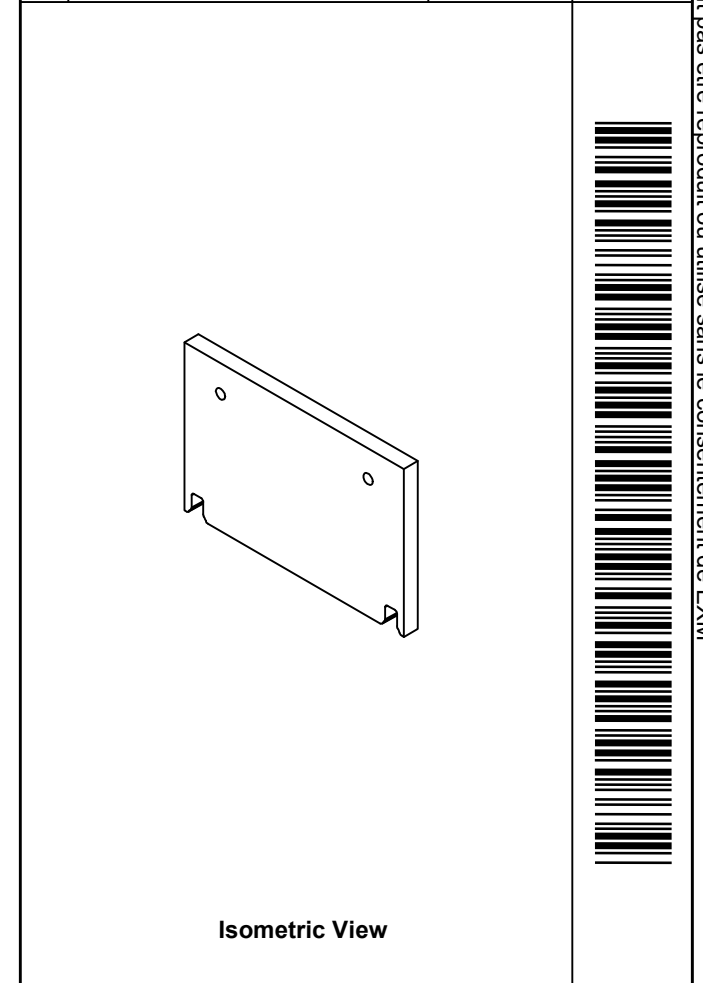

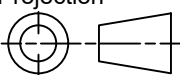
| | | |
|--|---------------------------|---------------------------|
|  Tél: (450) 979-4373 Fax: (450) 979-4626 www.exmweb.com | | Flatness Aplatissement |
| | | Max 3.0mm |
| Projection  | | Date |
| Customer Client | BoxCad: Patrick Deschenes | Date |
| Material Matière | Polyisocyanurate | |
| Color Couleur | Aluminum | Finish Fini |
| Description | | Detail Rev. |
| 5412ESSW 30" x 12" Top and Bottom Insulation | | |
| Part Number Numéro Pièce | Rev. | 14 |
| SEE BILL OF MATERIAL ON LAST PAGE | | 15 |

5412ESSW3012086THNOIPI-TP0

This drawing is confidential and must not be reproduced or used without the consent of EXM

Ce dessin est confidentiel et ne doit pas être reproduit ou utilisé sans le consentement de EXM

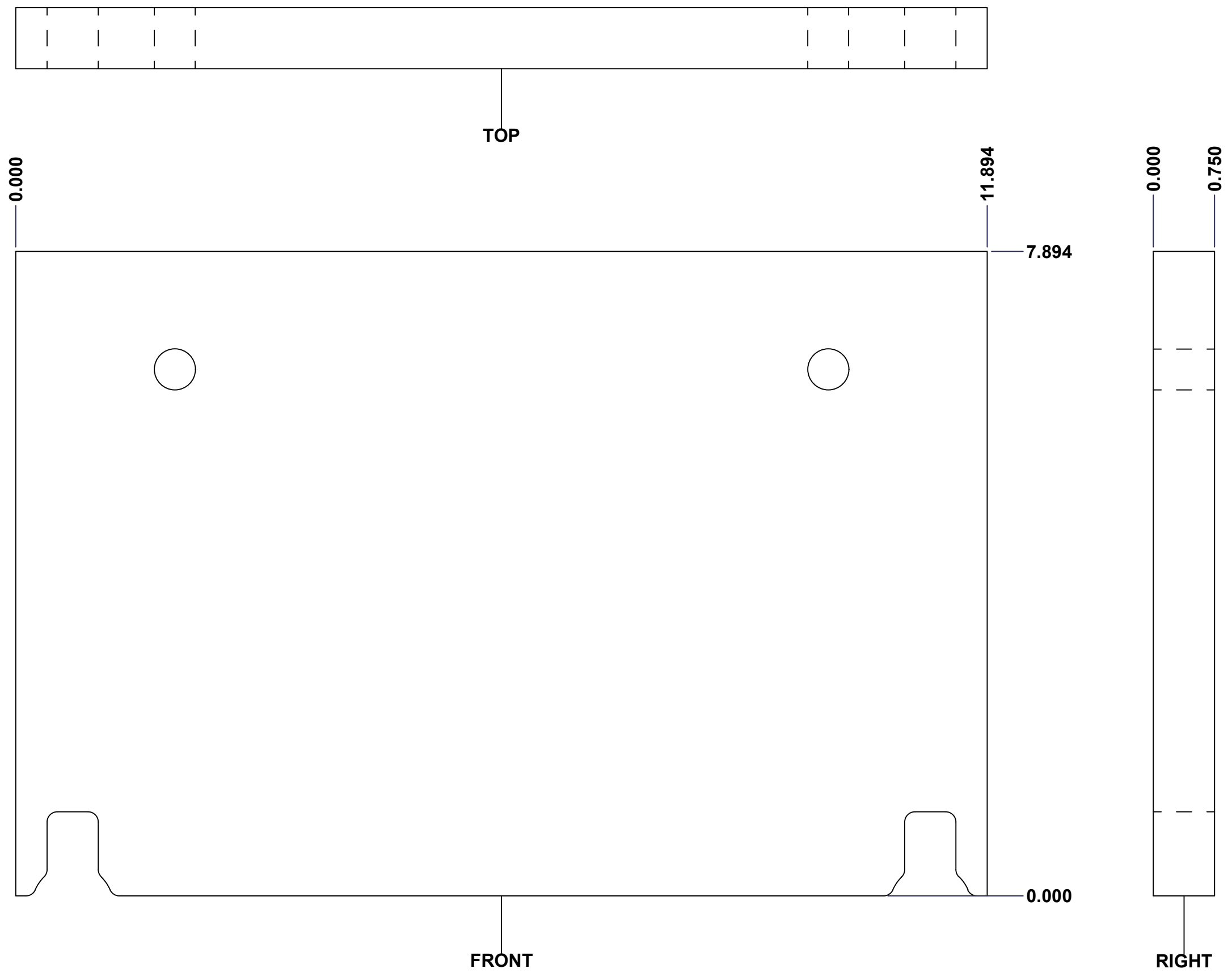

| No. | Revisions | Date | By/Par |
|-----|-----------|------|--------|
| | | | |
| | | | |
| | | | |
| | | | |
| | | | |

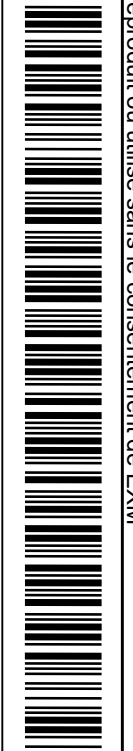
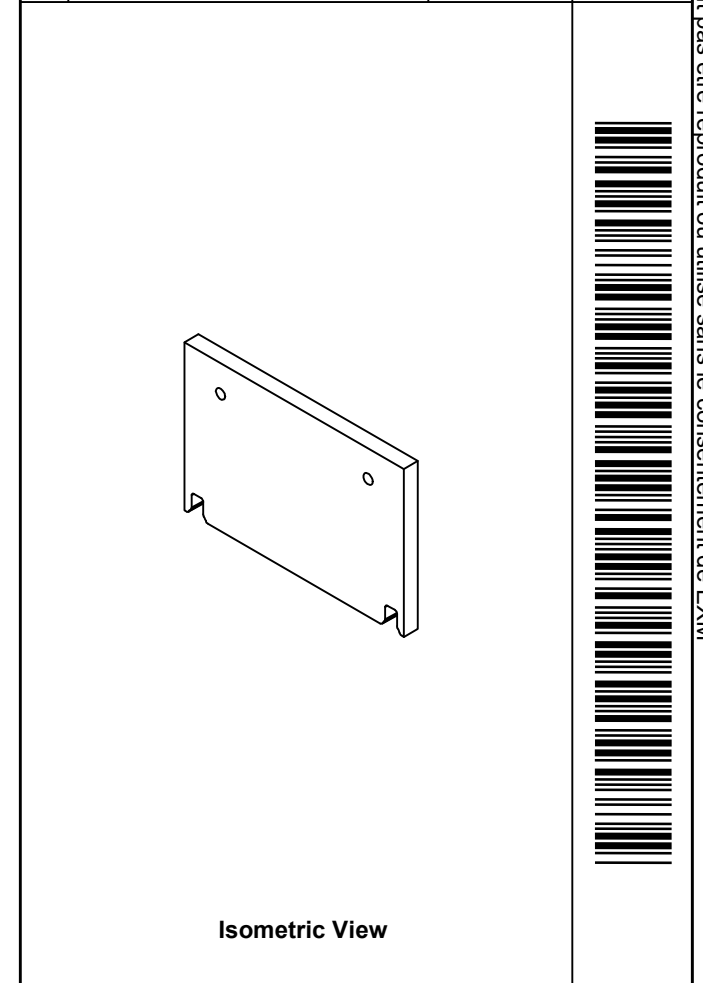

| | | |
|--|--------------------|---------------------------|
|  Tél: (450) 979-4373 Fax: (450) 979-4626 www.exmweb.com | | Flatness Aplatissement |
| | | Max 3.0mm |
| Customer Client | | Date |
| Drawn By Dessiné Par BoxCad: Patrick Deschenes | | Date 23-Jan-07 |
| Material Matière Polyisocyanurate | | |
| Color Couleur Aluminum | Finish Fini N/A | |
| Description 5412ESSW 30" x 12" Top and Bottom Insulation | | Detail Rev. |
| Part Number Numéro Pièce 5412ESSW3012086THNOIPI-BT0 | | Rev. 15 |

SEE BILL OF MATERIAL ON LAST PAGE