

This drawing is confidential and must not be reproduced or used without the consent of EXM

Ce dessin est confidentiel et ne doit pas être reproduit ou utilisé sans le consentement de EXM

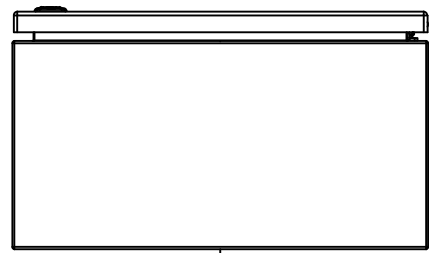

TOP

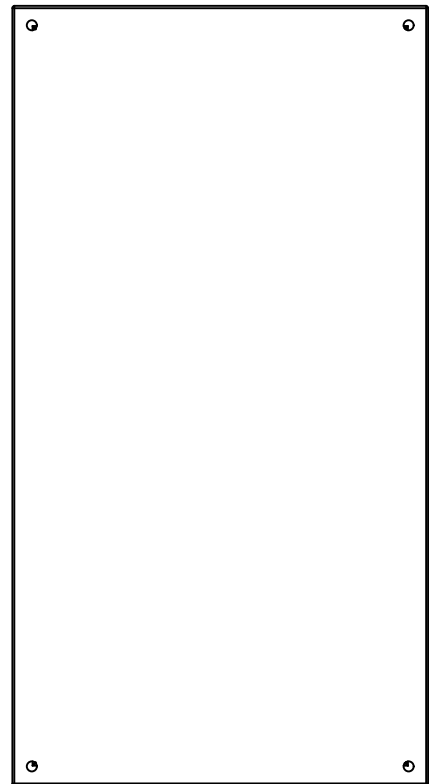

BACK

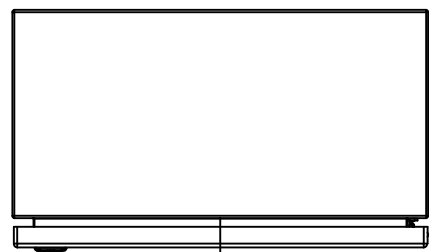

BOTTOM

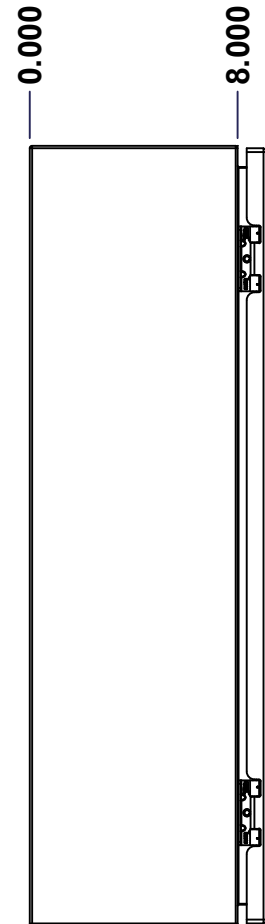

LEFT

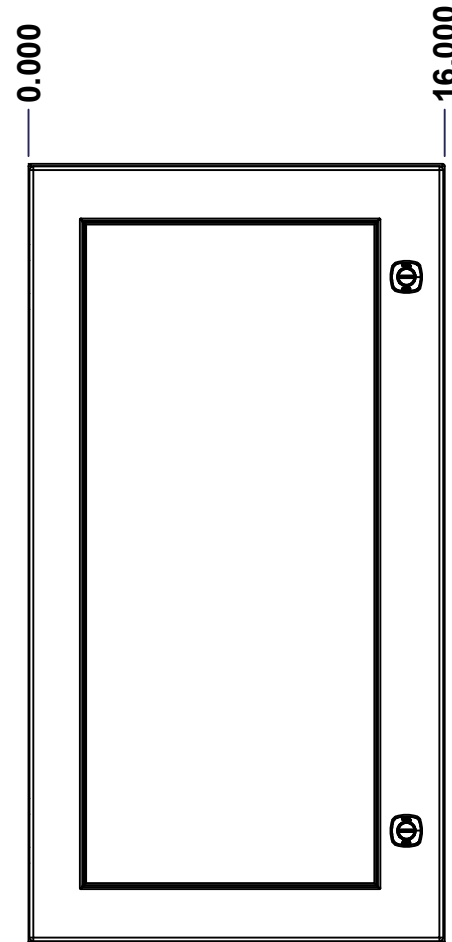

FRONT

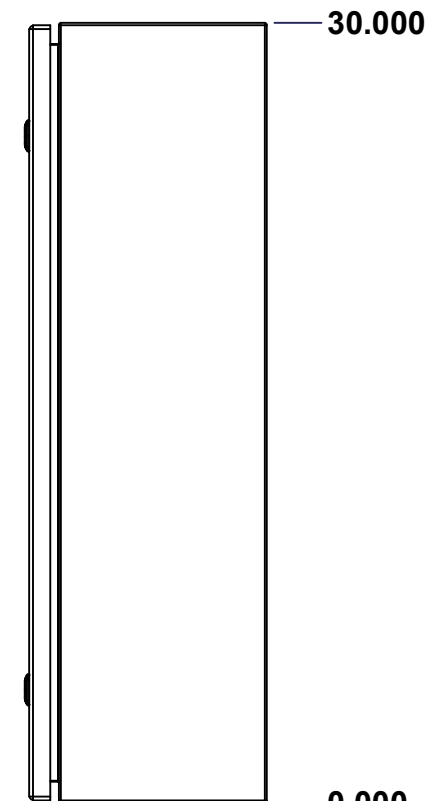

RIGHT

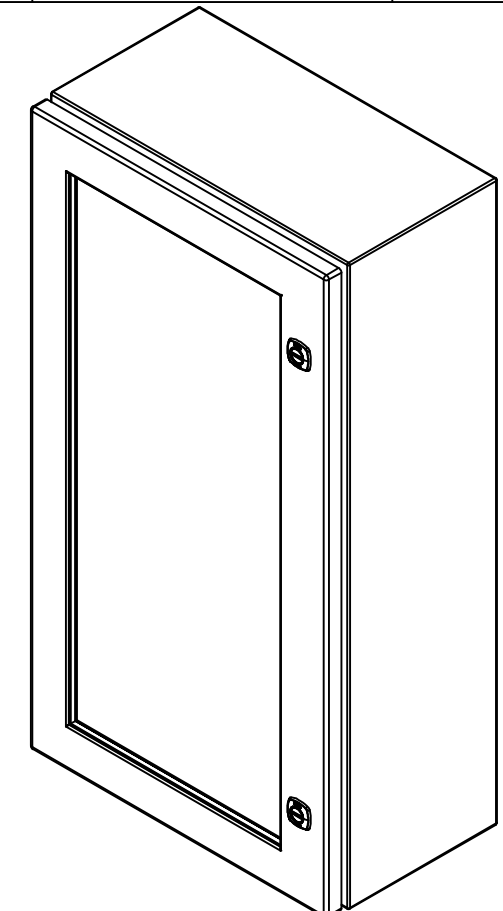

Isometric View



**GRAIN DIRECTION:  
TOP/BOTTOM: HORIZONTAL  
LEFT/RIGHT/BACK/FRONT: VERTICAL**

SEE BILL OF MATERIAL ON LAST PAGE

No.	Revisions	Date	By/Par

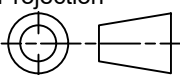
 Tél: (450) 979-4373 Fax: (450) 979-4626 <a href="http://www.exmweb.com">www.exmweb.com</a>		Flatness Aplatissement Max 3.0mm Projection 
Customer Client	Date	
Drawn By Dessiné Par	BoxCad: BoxCad	Date 28-Jun-23
Material Matière	16 Ga Stainless Steel 304 (1.4mm)	
Color Couleur	Unpainted	Finish Fini Brushed
Description	Detail Rev.	
5412ESSW 30" x 16" x 8" Assembly		
Part Number Numéro Pièce	Rev.	1
5412ESSW301608NOIP	0	9

This drawing is confidential and must not be reproduced or used without the consent of EXM

Ce dessin est confidentiel et ne doit pas être reproduit ou utilisé sans le consentement de EXM

NOTE	
ITEM	DESCRIPTION
1	NEMA 4X Enclosure
2	C/W Standard ground studs on box and cover
3	W/O Standard door stiffener
4	W/O Inner panel
5	C/W Standard inner panel mounting studs

No.	Revisions	Date	By/Par

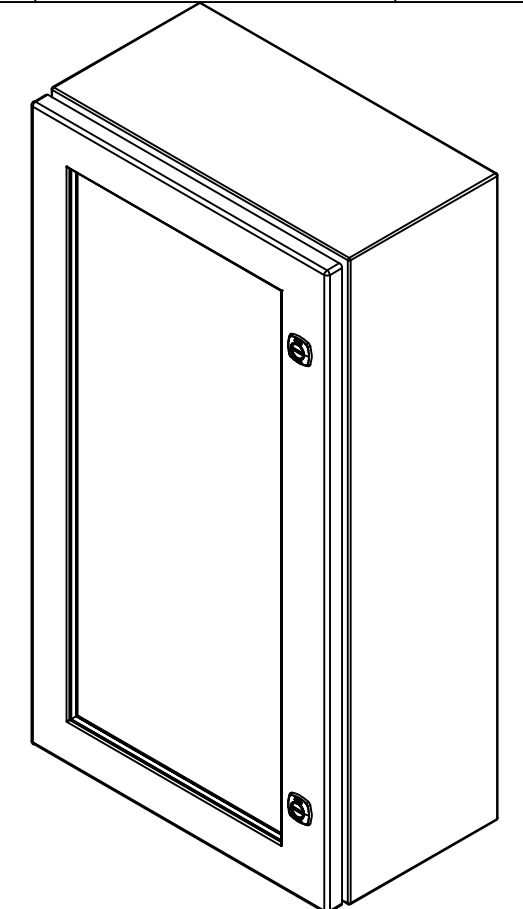

Isometric View



 Tél: (450) 979-4373  
 Fax: (450) 979-4626  
[www.exmweb.com](http://www.exmweb.com)

Flatness / Aplatissement: Max 3.0mm  
 Projection: 

Customer Client	Date
Drawn By / Dessiné Par: BoxCad: BoxCad	Date: 28-Jun-23
Material / Matière: 16 Ga Stainless Steel 304 (1.4mm)	

Color / Couleur: Unpainted	Finish / Fini: Brushed
Description: 5412ESSW 30" x 16" x 8" Assembly	Detail Rev.
Part Number / Numéro Pièce: <b>5412ESSW301608NOIP</b>	Rev. <b>0</b>

PACKING		
ITEM	QTY	DESCRIPTION
Cardboard sleeve	2	Top and Bottom
Cardboard strip	2	Between back of enclosure and inner panel
Plastic bag	1	To protect cover surface and inside gasket
Plastic strap - Black	2	To Squeeze the 2 cardboard sleeve together
Packaging label	1	White label with product number

Qty	Part Number	Rev	Description
1	STK-K-01800	5	5412 ES Accessory Kit
1	5412ESSW301608NOIPC	0	5412ESSW 30" x 16" Cover
1	5412ESSW301608NOIPB	0	5412ESSW 30" x 16" x 8" Body
2	STK-Q-04051-08	1	M6 x 8mm Stainless Steel Hexagon Socket Head Machine Screw with Nyseal

Parts List

This drawing is confidential and must not be reproduced or used without the consent of EXM

Ce dessin est confidentiel et ne doit pas être reproduit ou utilisé sans le consentement de EXM

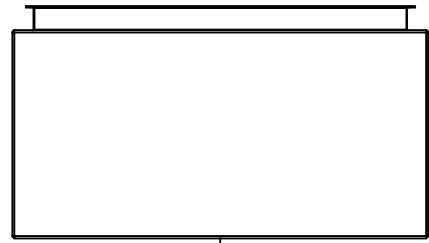

TOP

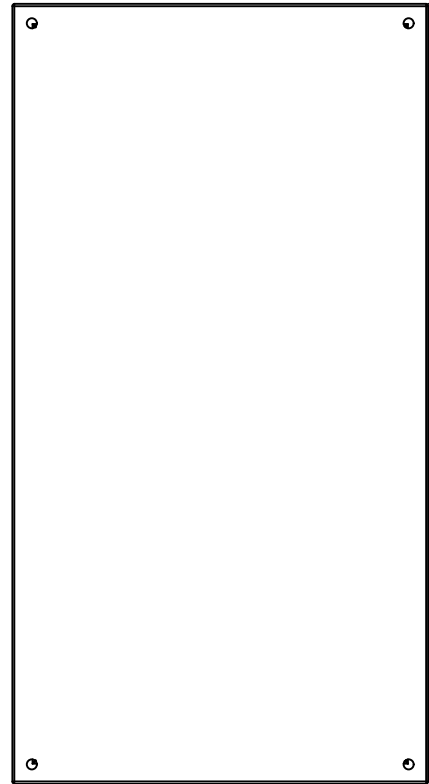

BACK

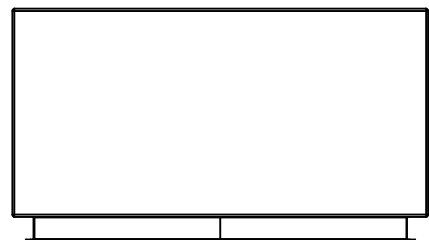

BOTTOM

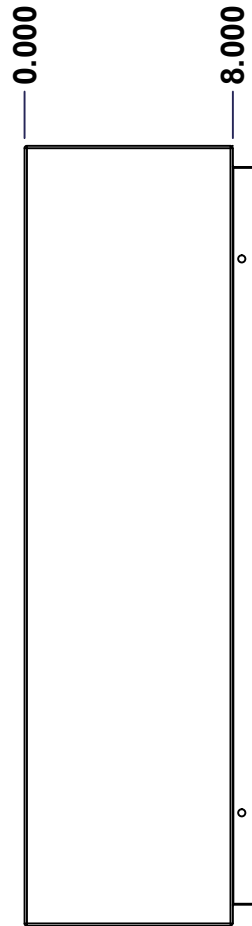

LEFT

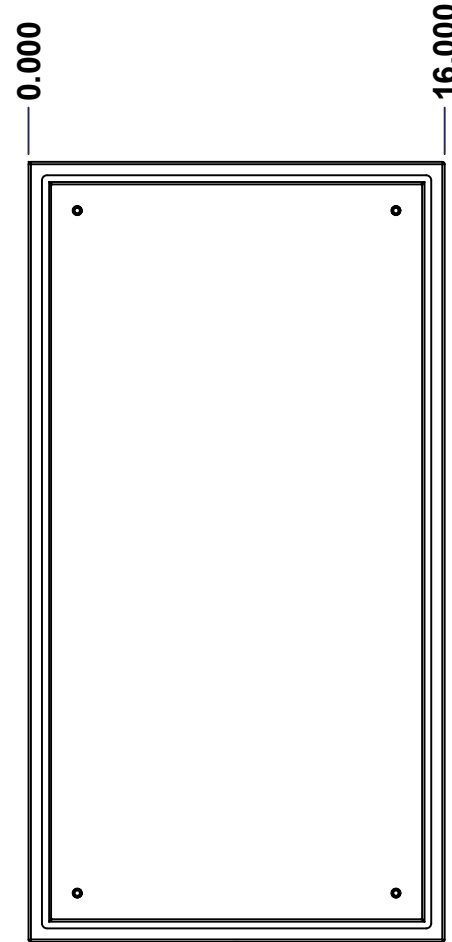

FRONT

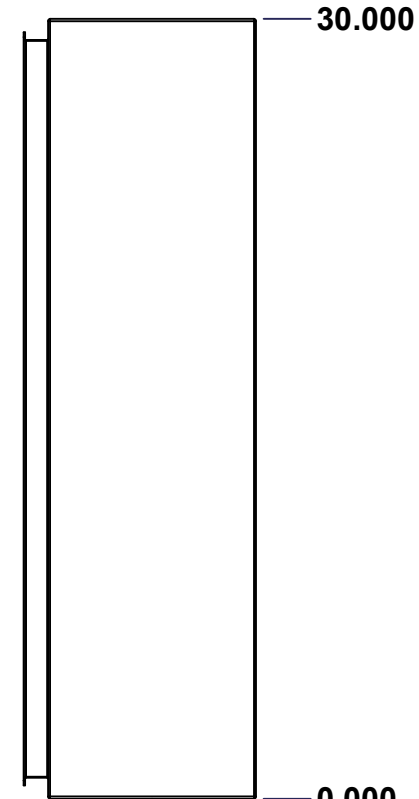

RIGHT

No.	Revisions	Date	By/Par

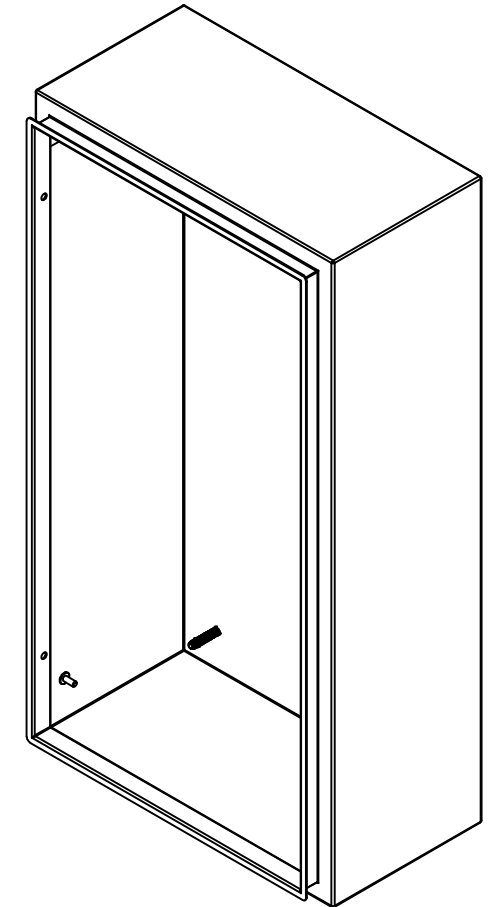

Isometric View



Tél: (450) 979-4373  
 Fax: (450) 979-4626  
[www.exmweb.com](http://www.exmweb.com)

Flatness  
Aplatissement

Max 3.0mm

Projection

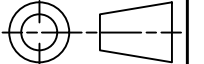

Customer Client	Date
Drawn By Dessiné Par BoxCad: BoxCad	Date 28-Jun-23
Material Matière 16 Ga Stainless Steel 304 (1.4mm)	
Color Couleur Unpainted	Finish Fini Brushed
Description 5412ESSW 30" x 16" x 8" Body	Detail Rev.
Part Number Numéro Pièce 5412ESSW301608NOIPB	Rev. 3
	0

SEE BILL OF MATERIAL ON LAST PAGE

This drawing is confidential and must not be reproduced or used without the consent of EXM

Ce dessin est confidentiel et ne doit pas être reproduit ou utilisé sans le consentement de EXM

STANDARD FEATURES ARE NOT LISTED IN THIS HOLE TABLE			
HOLE TABLE - LEFT VIEW (CUSTOM FEATURE ONLY)			
CUT-OUT	XDIM	YDIM	DESCRIPTION
1	6.500	2.000	GND STUD M6 x 16mm (Inside)
2	6.000	28.000	LABEL_EXM (Inside)

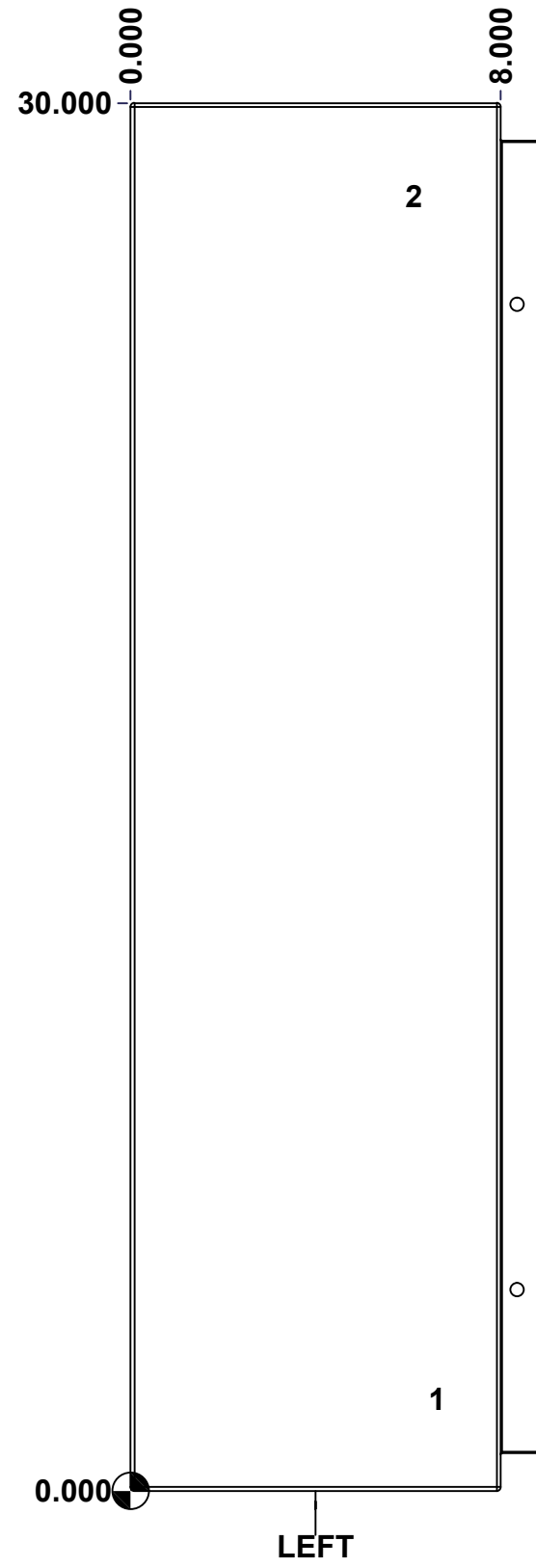

	Description	Status
	5412ESSW 30" x 16" x 8" Body	(NULL)
	Part Number Numéro Pièce	Rev.
	<b>5412ESSW301608NOIPB</b>	<b>0</b> / 4 9

This drawing is confidential and must not be reproduced or used without the consent of EXM

Ce dessin est confidentiel et ne doit pas être reproduit ou utilisé sans le consentement de EXM

**STANDARD FEATURES ARE NOT LISTED IN THIS HOLE TABLE**

**HOLE TABLE - BACK VIEW (CUSTOM FEATURE ONLY)**

CUT-OUT	XDIM	YDIM	DESCRIPTION
1	1.875	1.875	IP STUD M8 x 35mm (Inside)
2	1.875	28.125	IP STUD M8 x 35mm (Inside)
3	14.125	28.125	IP STUD M8 x 35mm (Inside)
4	14.125	1.875	IP STUD M8 x 35mm (Inside)
-----			
5	15.250	0.750	RND Ø0.390
6	15.250	29.250	RND Ø0.390
7	0.750	29.250	RND Ø0.390
8	0.750	0.750	RND Ø0.390

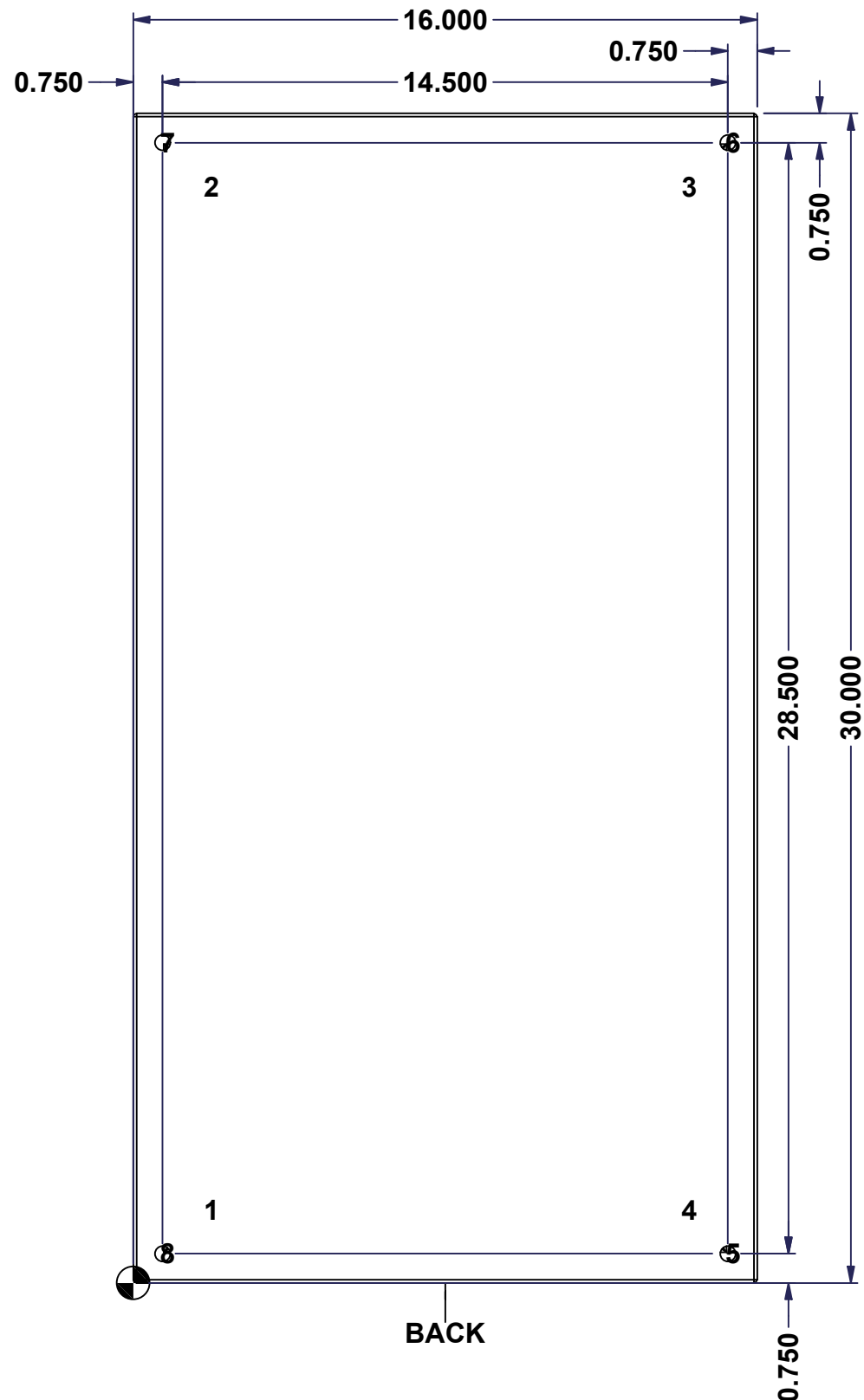

	Description	Status
	5412ESSW 30" x 16" x 8" Body	(NULL)
	Part Number	Rev.
	Numéro Pièce	5
	<b>5412ESSW301608NOIPB</b>	<b>0</b>
		9

This drawing is confidential and must not be reproduced or used without the consent of EXM

Ce dessin est confidentiel et ne doit pas être reproduit ou utilisé sans le consentement de EXM

No.	Revisions	Date	By/Par

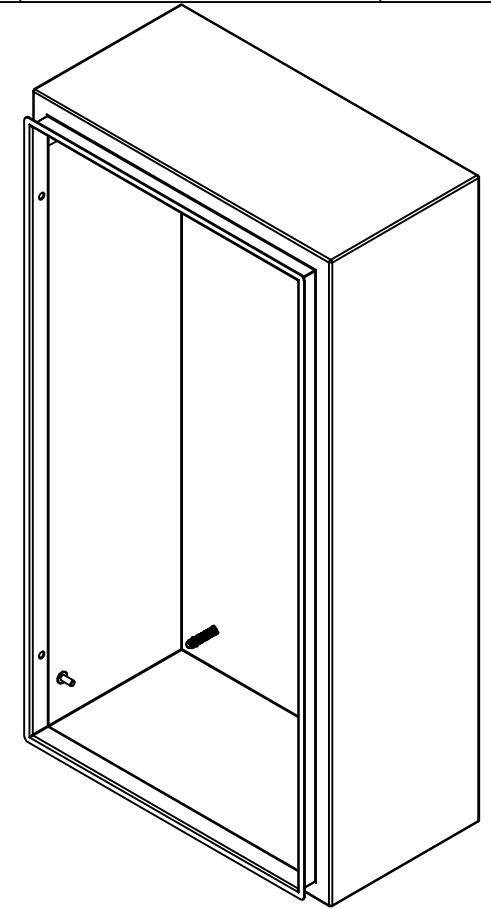

Isometric View



Tél: (450) 979-4373  
 Fax: (450) 979-4626  
[www.exmweb.com](http://www.exmweb.com)

Flatness  
Aplatissement  
Max 3.0mm  
Projection

Customer Client	Date
Drawn By / Dessiné Par: BoxCad: BoxCad	Date: 28-Jun-23
Material / Matière: 16 Ga Stainless Steel 304 (1.4mm)	

Color / Couleur: Unpainted	Finish / Fini: Brushed
----------------------------	------------------------

Description: 5412ESSW 30" x 16" x 8" Body	Detail Rev.
---	-------------

Part Number / Numéro Pièce: <b>5412ESSW301608NOIPB</b>	Rev. 0	6 / 9
--	--------	-------

Qty	Part Number	Rev	Description
1	STK-S-00100	0	3.5" x 2" Silver Milar Flexcon Sticker
1	STK-Q-16085	0	Ground Stud M6 x 16mm Stainless Steel
4	STK-Q-16020	1	Stud M8 x 35mm Stainless Steel
1	5412ESSW301608NOIPB-P	0	5412ESSW 30" x 16" x 8" Body Part
Parts List			

This drawing is confidential and must not be reproduced or used without the consent of EXM

Ce dessin est confidentiel et ne doit pas être reproduit ou utilisé sans le consentement de EXM

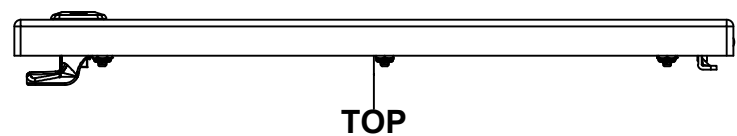

TOP

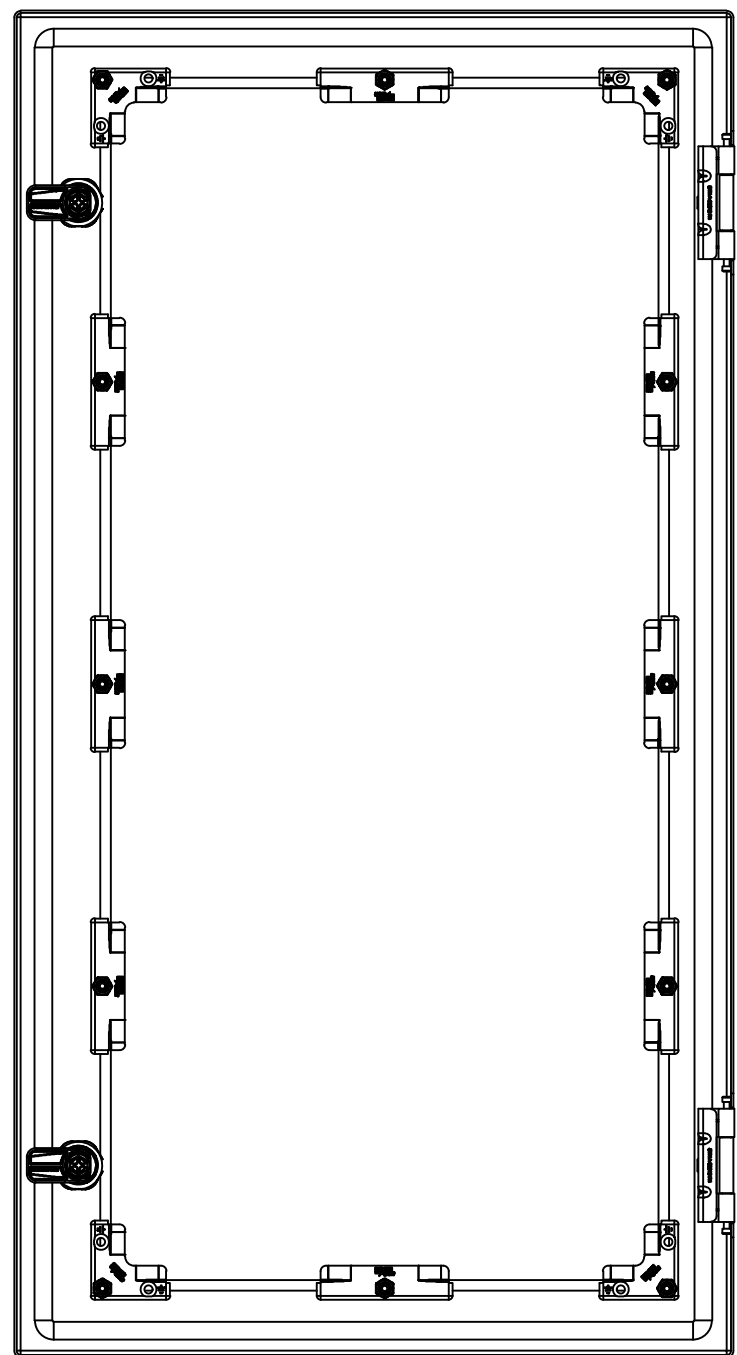

BACK



BOTTOM

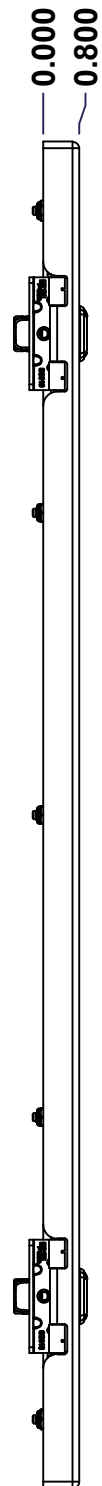

LEFT

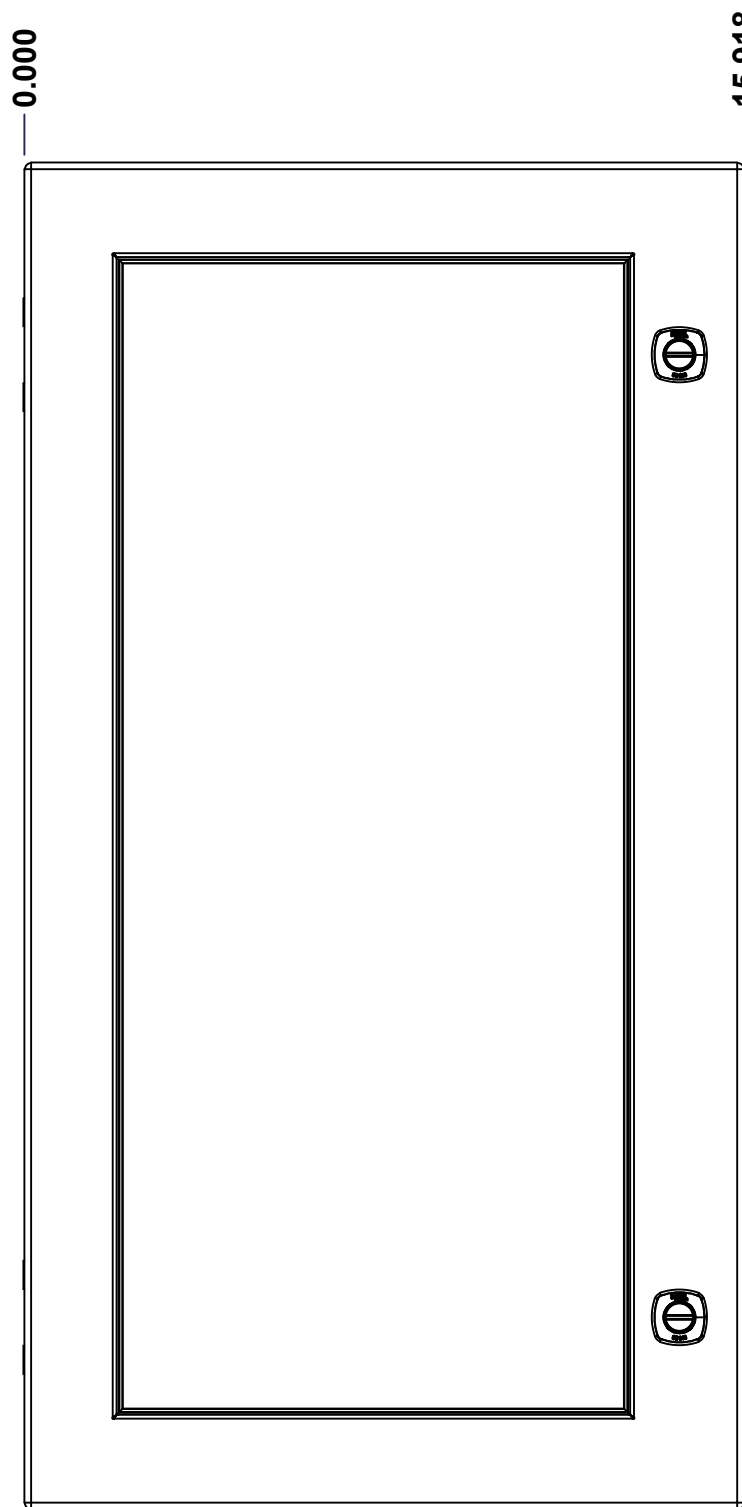

FRONT

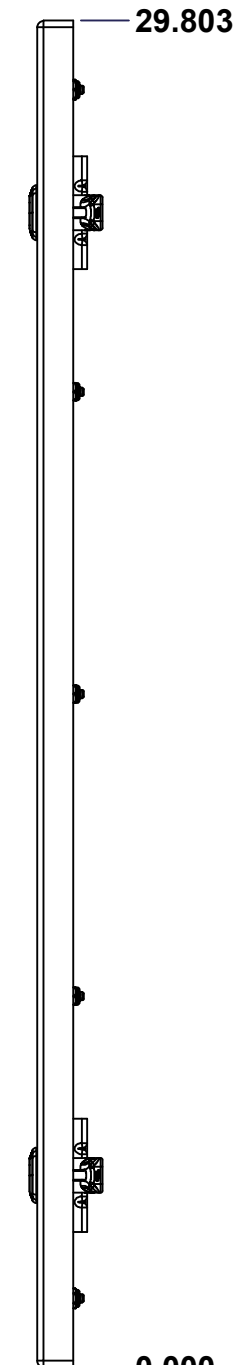

RIGHT

0.000  
0.800

0.000

15.918

29.803

0.000

No.	Revisions	Date	By/Par

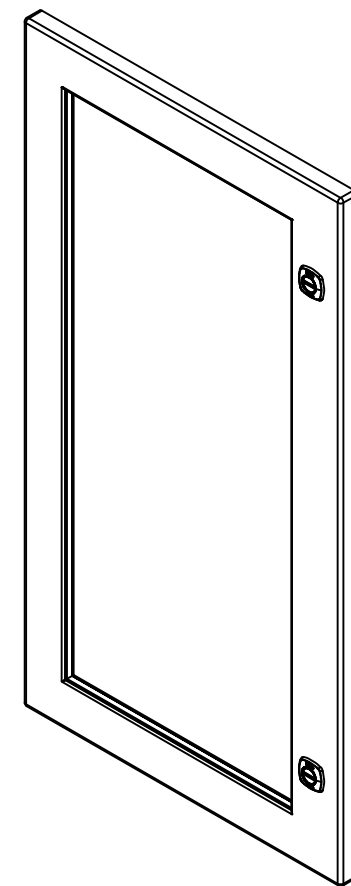

Isometric View

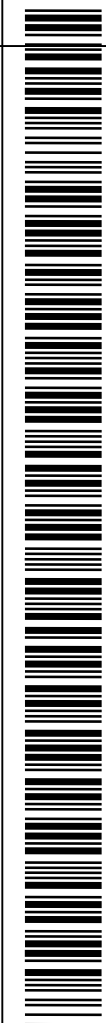

Tél: (450) 979-4373  
Fax: (450) 979-4626  
[www.exmweb.com](http://www.exmweb.com)

Flatness  
Aplatissement

Max 3.0mm

Projection

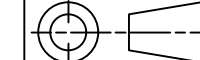

Customer Client \_\_\_\_\_ Date \_\_\_\_\_

Drawn By Dessiné Par BoxCad: BoxCad Date 28-Jun-23

Material Matière 16 Ga Stainless Steel 304 (1.4mm)

Color Couleur Unpainted Finish Fini Brushed

Description 5412ESSW 30" x 16" Cover Detail Rev. \_\_\_\_\_

Part Number Numéro Pièce \_\_\_\_\_ Rev. 7

SEE BILL OF MATERIAL ON LAST PAGE **5412ESSW301608NOIPC** 0 9

This drawing is confidential and must not be reproduced or used without the consent of EXM

Ce dessin est confidentiel et ne doit pas être reproduit ou utilisé sans le consentement de EXM

**STANDARD FEATURES ARE NOT LISTED IN THIS HOLE TABLE**

**HOLE TABLE - FRONT VIEW (CUSTOM FEATURE ONLY)**

CUT-OUT	XDIM	YDIM	DESCRIPTION
1	1.469	8.214	STUD M6 x 18mm (Inside)
2	13.968	8.214	STUD M6 x 18mm (Inside)
3	1.469	14.902	STUD M6 x 18mm (Inside)
4	13.968	14.902	STUD M6 x 18mm (Inside)
5	1.469	21.589	STUD M6 x 18mm (Inside)
6	13.968	21.589	STUD M6 x 18mm (Inside)
7	1.469	28.276	STUD M6 x 18mm (Inside)
8	1.469	1.527	STUD M6 x 18mm (Inside)
9	7.719	28.276	STUD M6 x 18mm (Inside)
10	7.719	1.527	STUD M6 x 18mm (Inside)
11	13.968	28.276	STUD M6 x 18mm (Inside)
12	13.968	1.527	STUD M6 x 18mm (Inside)
-----			
13	14.494	25.553	880 SCQ4-SLSS6
14	14.494	4.250	880 SCQ4-SLSS6

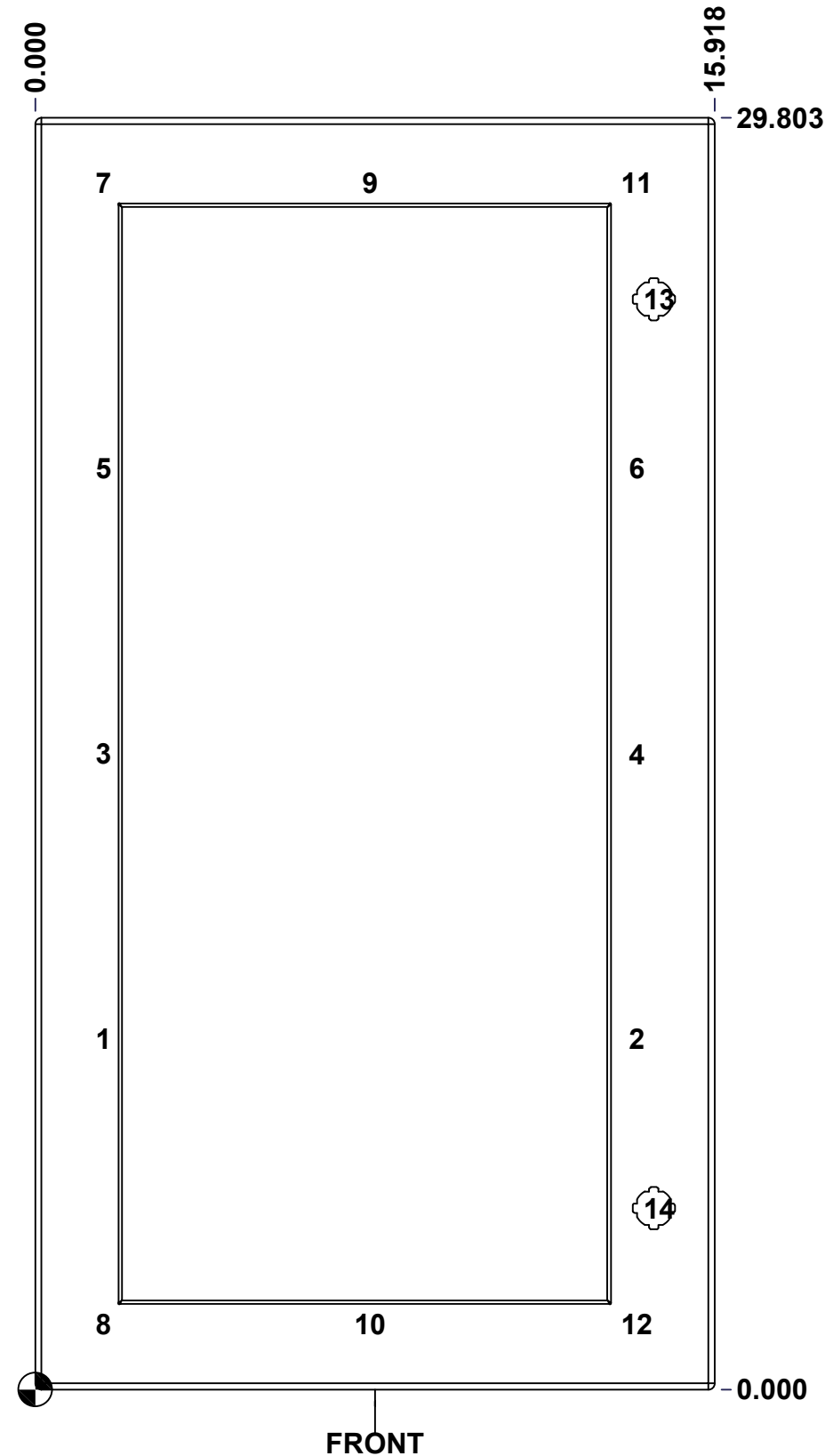

	Description	Status
	5412ESSW 30" x 16" Cover	(NULL)
	Part Number Numéro Pièce	Rev.
	<b>5412ESSW301608NOIPC</b>	<b>0</b> / 8 / 9



This drawing is confidential and must not be reproduced or used without the consent of EXM

Ce dessin est confidentiel et ne doit pas être reproduit ou utilisé sans le consentement de EXM

No.	Revisions	Date	By/Par

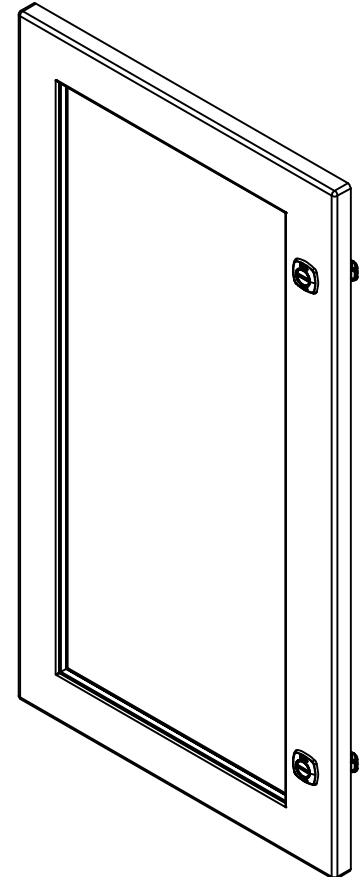

Isometric View



QTY	Part Number	Rev	Description
8	STK-Q-60701	2.1	880 WK - Lexan 1/4" Fixing Bracket
1	STK-A-60703	0	5412 ESW Lexan Bracket Kit
12	STK-Q-16053	1	Stud M6 x 23mm Stainless steel
1	STK-G-02710	0	880 HWKG - Windows Kit Gasket
1	5412ESSW301608NOIPL XG	0	5412ESSW 30" x 16" Lexan Gasket Part
1	5412ESSW301608NOIPL X	0	5412ESSW 26.375" x 12.125" Lexan Part
1	5412ESSW301608NOIPG	0	5412ESSW 30" x 16" Cover Gasket Part
1	5412ESSW301608NOIPC-P	0	5412ESSW 30" x 16" Cover Part
2	880 SCQ4-SLSS6	7	5412 ESS 1/4 Turn Lock
2	STK-A-33016	0	5412 ESS Bended Hinge (Body Part)
Parts List			



Tél: (450) 979-4373  
Fax: (450) 979-4626  
[www.exmweb.com](http://www.exmweb.com)

Flatness  
Aplatissement  
Max 3.0mm

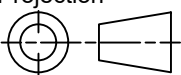
Projection  

Customer Client	Date
Drawn By Dessiné Par: BoxCad: BoxCad	Date: 28-Jun-23
Material Matière: 16 Ga Stainless Steel 304 (1.4mm)	
Color Couleur: Unpainted	Finish Fini: Brushed
Description: 5412ESSW 30" x 16" Cover	
Detail Rev.	
Part Number Numéro Pièce: <b>5412ESSW301608NOIPC</b>	Rev. 9 <b>0</b>