

This drawing is confidential and must not be reproduced or used without the consent of EXM

Ce dessin est confidentiel et ne doit pas être reproduit ou utilisé sans le consentement de EXM

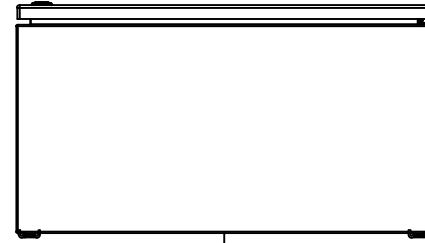

TOP

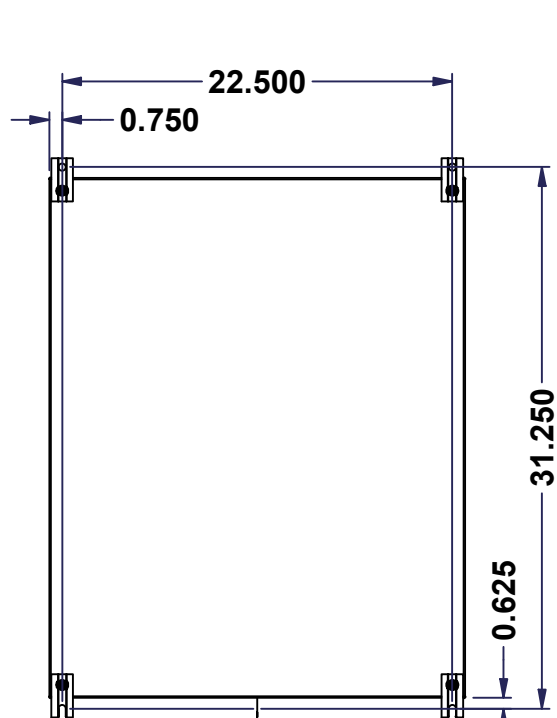

BACK

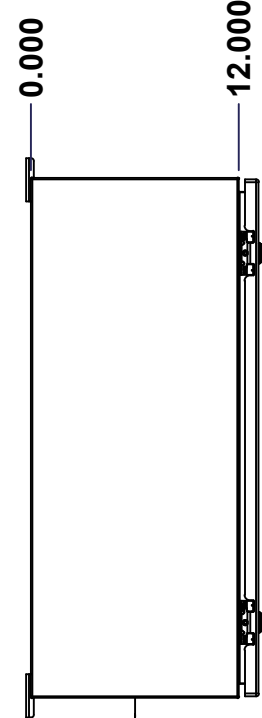

LEFT

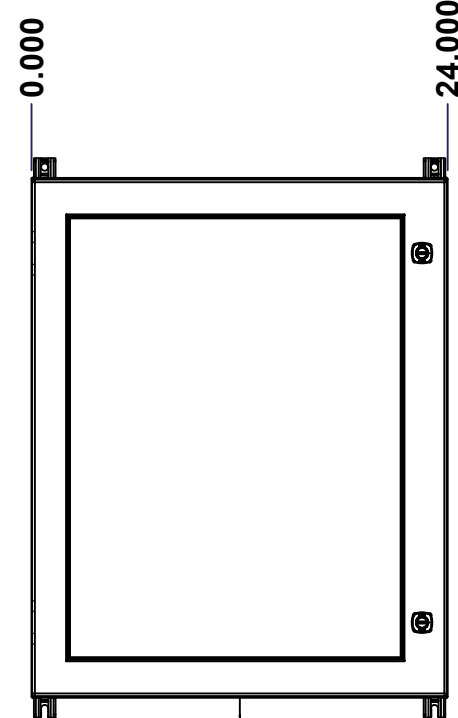

FRONT

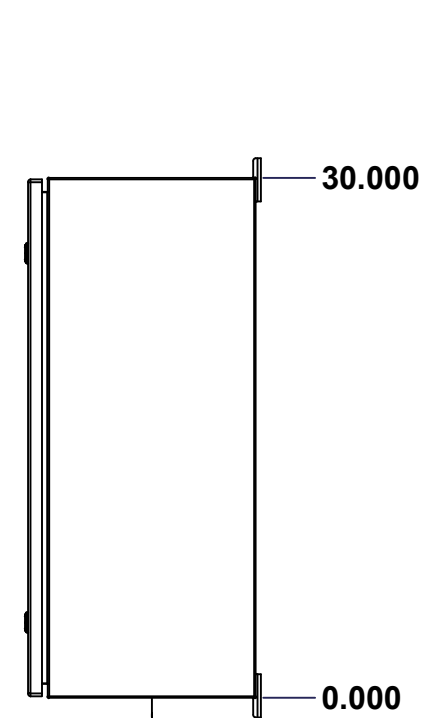

RIGHT

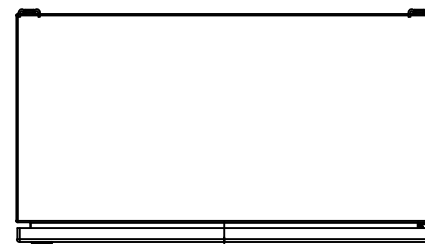

BOTTOM

No.	Revisions	Date	By/Par

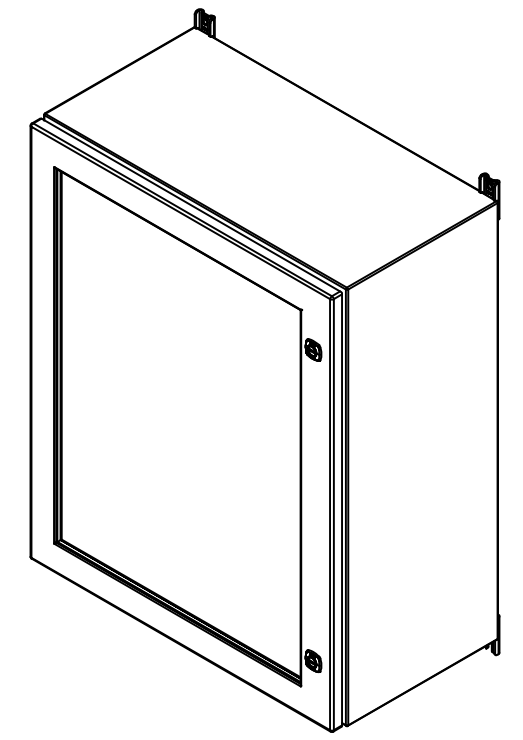

Isometric View

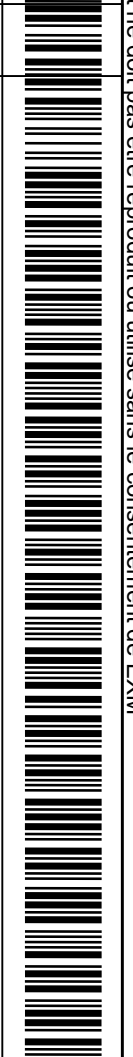

**GRAIN DIRECTION:  
TOP/BOTTOM: HORIZONTAL  
LEFT/RIGHT/BACK/FRONT: VERTICAL**

	Flatness Aplatissement Max 3.0mm
	Projection 
Tél: (450) 979-4373 Fax: (450) 979-4626 <a href="http://www.exmweb.com">www.exmweb.com</a>	Customer Client Date
Drawn By Dessiné Par BoxCad: BoxCad	Date 13-Jun-23
Material Matière 16 Ga Stainless Steel 316 (1.4mm)	Color Couleur Unpainted
Description 5412ESSW 30" x 24" x 12" Assembly	Finish Fini Brushed
Part Number Numéro Pièce 5412ESSW3024126THNOIP	Detail Rev. Rev. 1

SEE BILL OF MATERIAL ON LAST PAGE 5412ESSW3024126THNOIP 0 15

This drawing is confidential and must not be reproduced or used without the consent of EXM

Ce dessin est confidentiel et ne doit pas être reproduit ou utilisé sans le consentement de EXM

NOTE	
ITEM	DESCRIPTION
1	NEMA 4X Enclosure
2	C/W Standard ground studs on box and cover
3	W/O Standard door stiffener
4	W/O Inner panel
5	C/W Standard inner panel mounting studs
6	C/W 885 ESMF4_OPEN Sold separately (Installed)
7	C/W 885 ESMF4_CLOSE Sold separately (Installed)
8	C/W R5 Insulation (Installed by EXM)

No.	Revisions	Date	By/Par

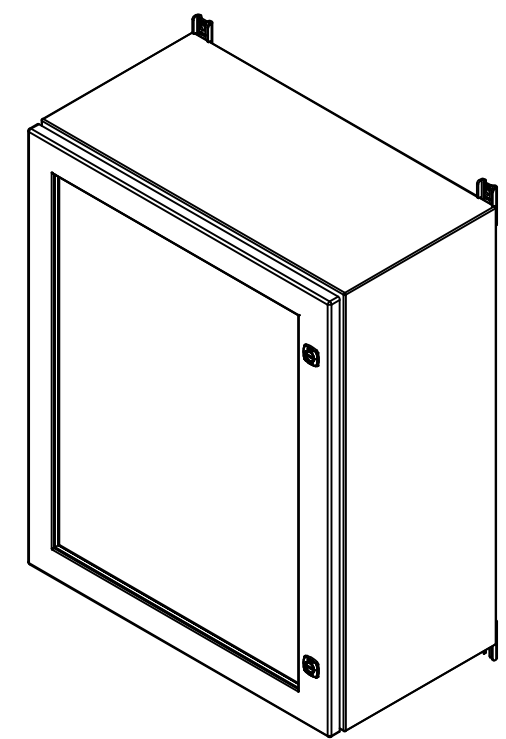

Isometric View



 Tél: (450) 979-4373  
 Fax: (450) 979-4626  
[www.exmweb.com](http://www.exmweb.com)

Flatness / Aplatissement: Max 3.0mm  
 Projection: 

Customer Client	Date
Drawn By / Dessiné Par: BoxCad: BoxCad	Date: 13-Jun-23

Material / Matière: 16 Ga Stainless Steel 316 (1.4mm)

Color / Couleur: Unpainted	Finish / Fini: Brushed
----------------------------	------------------------

Description: 5412ESSW 30" x 24" x 12" Assembly

Part Number / Numéro Pièce: <b>5412ESSW3024126THNOIP</b>	Rev. 0	2	15
--	--------	---	----

Qty	Part Number	Rev	Description
4	STK-Q-00600	2	M12 to M8 Adaptor
1	STK-K-01800	5	5412 ES Accessory Kit
1	5412ESSW3024126THNO IPC	0	5412ESSW 30" x 24" Cover
1	5412ESSW3024126THNO IPB	0	5412ESSW 30" x 24" x 12" Body
2	STK-Q-04051-08	1	M6 x 8mm Stainless Steel Hexagon Socket Head Machine Screw with Nyseal

Parts List

PACKING		
ITEM	QTY	DESCRIPTION
Cardboard sleeve	2	Top and Bottom
Cardboard strip	2	Between back of enclosure and inner panel
Plastic bag	1	To protect cover surface and inside gasket
Plastic strap - Black	2	To Squeeze the 2 cardboard sleeve together
Packaging label	1	White label with product number

This drawing is confidential and must not be reproduced or used without the consent of EXM

Ce dessin est confidentiel et ne doit pas être reproduit ou utilisé sans le consentement de EXM

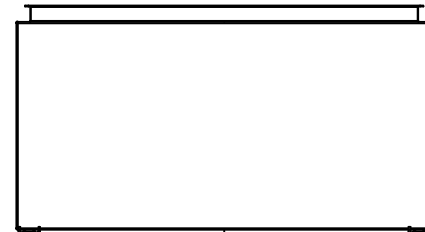

TOP

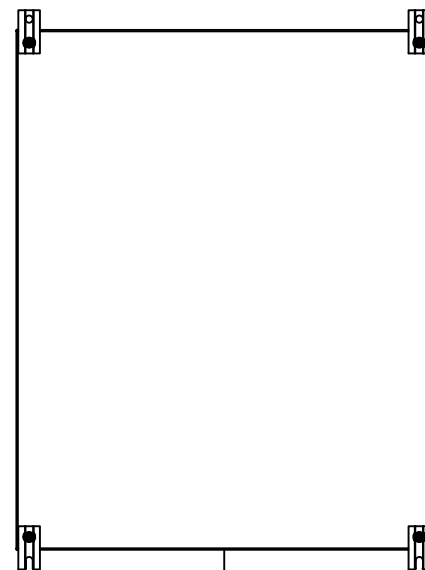

BACK

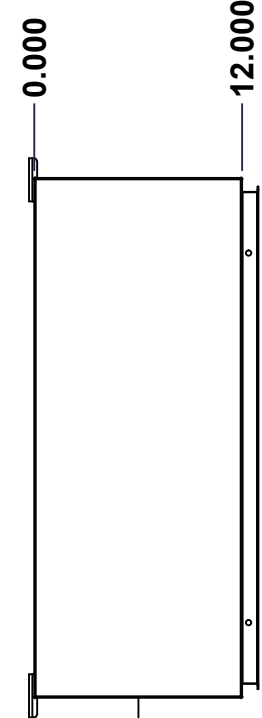

LEFT

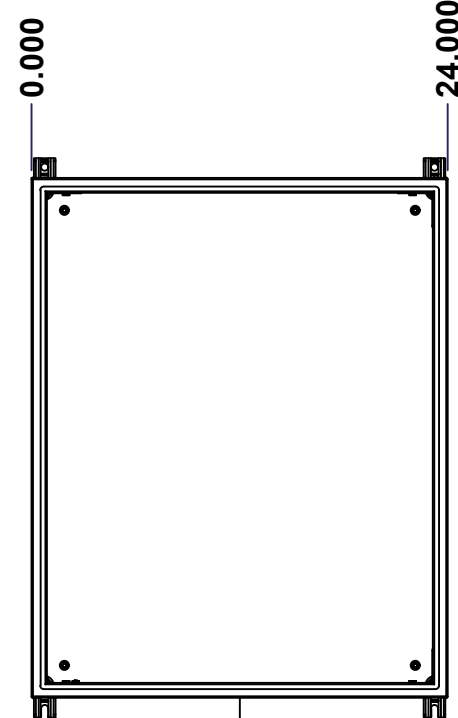

FRONT

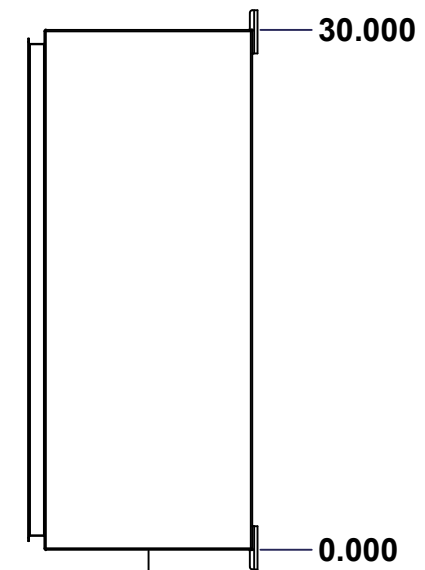

RIGHT

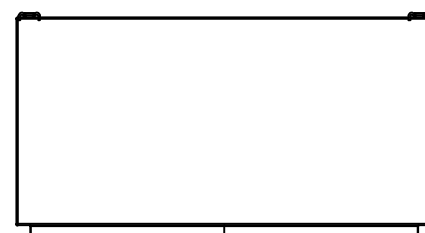

BOTTOM

No.	Revisions	Date	By/Par

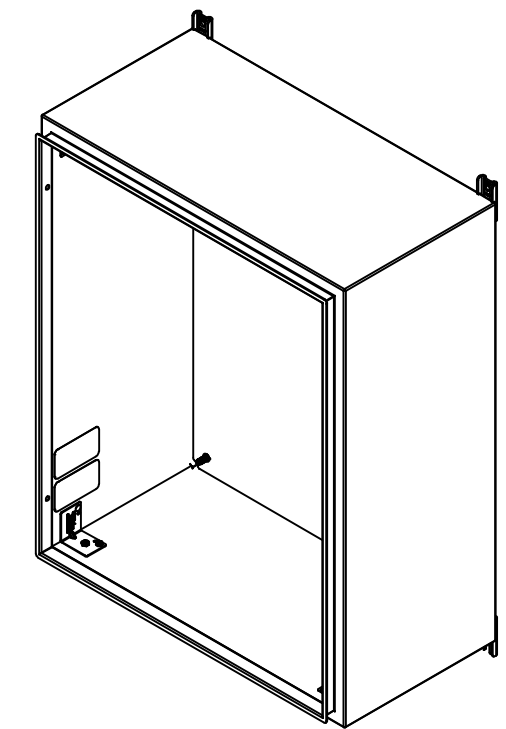

Isometric View

	Flatness Aplatissement Max 5.0mm
	Projection 
Tél: (450) 979-4373 Fax: (450) 979-4626 <a href="http://www.exmweb.com">www.exmweb.com</a>	Date 13-Jun-23
Customer Client	Date 13-Jun-23
Drawn By Dessiné Par BoxCad: BoxCad	Date 13-Jun-23
Material Matière 16 Ga Stainless Steel 316 (1.4mm)	
Color Couleur Unpainted	Finish Fini Brushed
Description 5412ESSW 30" x 24" x 12" Body	
Part Number Numéro Pièce 5412ESSW3024126THNOIP	Rev. 3 0

SEE BILL OF MATERIAL ON LAST PAGE 5412ESSW3024126THNOIPB 0 15

This drawing is confidential and must not be reproduced or used without the consent of EXM

Ce dessin est confidentiel et ne doit pas être reproduit ou utilisé sans le consentement de EXM

STANDARD FEATURES ARE NOT LISTED IN THIS HOLE TABLE			
HOLE TABLE - TOP VIEW (CUSTOM FEATURE ONLY)			
CUT-OUT	XDIM	YDIM	DESCRIPTION
1	2.000	10.500	INSUL. STUD M6 x 18mm (Inside)
2	22.000	10.500	INSUL. STUD M6 x 18mm (Inside)

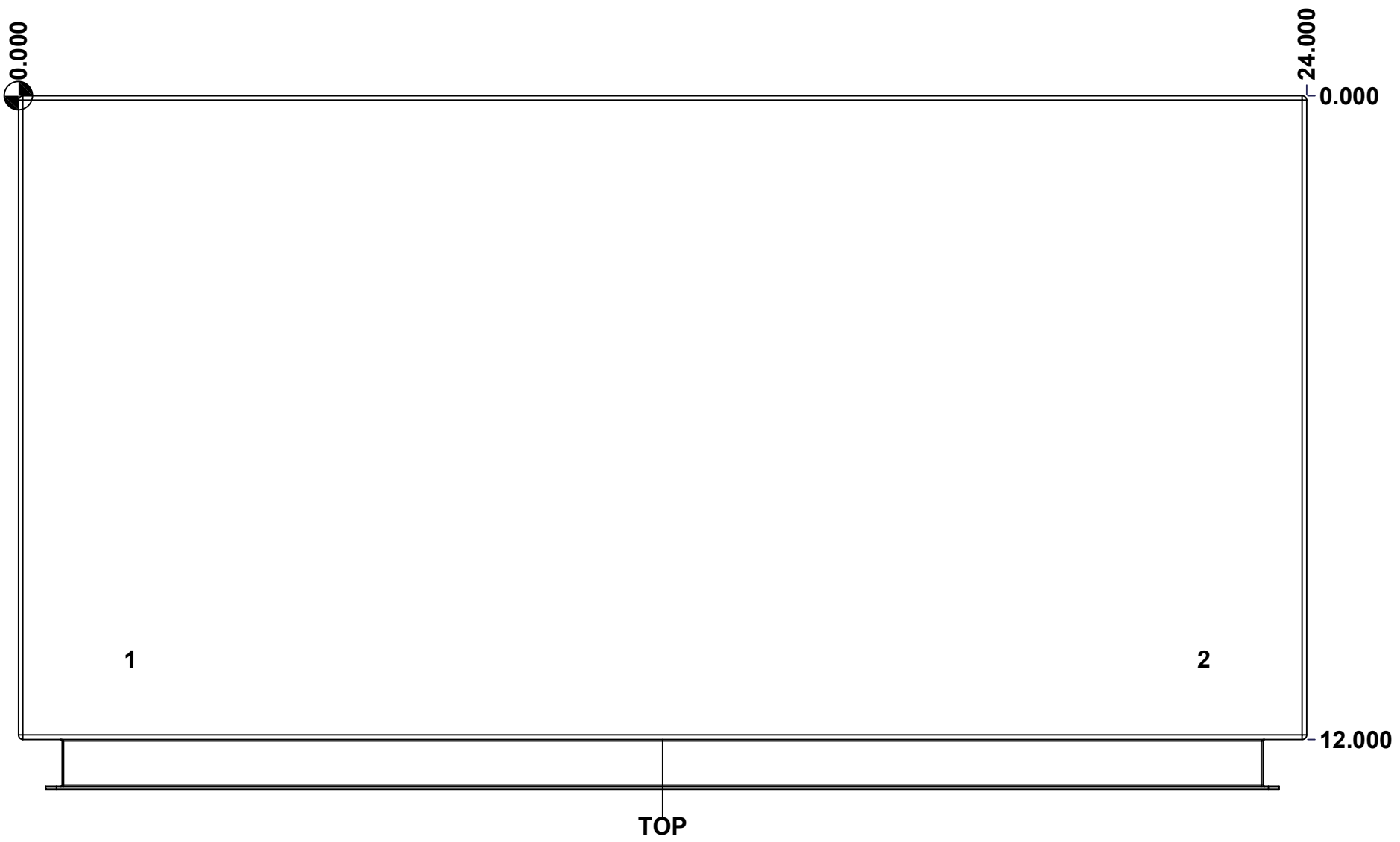

	Description	Status
	5412ESSW 30" x 24" x 12" Body	(NULL)
	Part Number Numéro Pièce	Rev.
	<b>5412ESSW3024126THNOIPB 0</b>	4
		15

This drawing is confidential and must not be reproduced or used without the consent of EXM

Ce dessin est confidentiel et ne doit pas être reproduit ou utilisé sans le consentement de EXM

<b>STANDARD FEATURES ARE NOT LISTED IN THIS HOLE TABLE</b>			
<b>HOLE TABLE - BOTTOM VIEW (CUSTOM FEATURE ONLY)</b>			
CUT-OUT	XDIM	YDIM	DESCRIPTION
1	2.000	10.500	INSUL. STUD M6 x 18mm (Inside)
2	22.000	10.500	INSUL. STUD M6 x 18mm (Inside)



	Description	Status
	5412ESSW 30" x 24" x 12" Body	(NULL)
	Part Number Numéro Pièce	Rev. 5
	<b>5412ESSW3024126THNOIPB 0</b>	15

This drawing is confidential and must not be reproduced or used without the consent of EXM

Ce dessin est confidentiel et ne doit pas être reproduit ou utilisé sans le consentement de EXM

**STANDARD FEATURES ARE NOT LISTED IN THIS HOLE TABLE**

**HOLE TABLE - BACK VIEW (CUSTOM FEATURE ONLY)**

CUT-OUT	XDIM	YDIM	DESCRIPTION
1	1.875	1.875	IP STUD M8 x 35mm (Inside)
2	1.875	28.125	IP STUD M8 x 35mm (Inside)
3	22.125	28.125	IP STUD M8 x 35mm (Inside)
4	22.125	1.875	IP STUD M8 x 35mm (Inside)
-----			
5	23.250	0.000	FOOT 885 ESMF4_OPEN
6	0.750	0.000	FOOT 885 ESMF4_OPEN
7	23.250	30.000	FOOT 885 ESMF4_CLOSE
8	0.750	30.000	FOOT 885 ESMF4_CLOSE

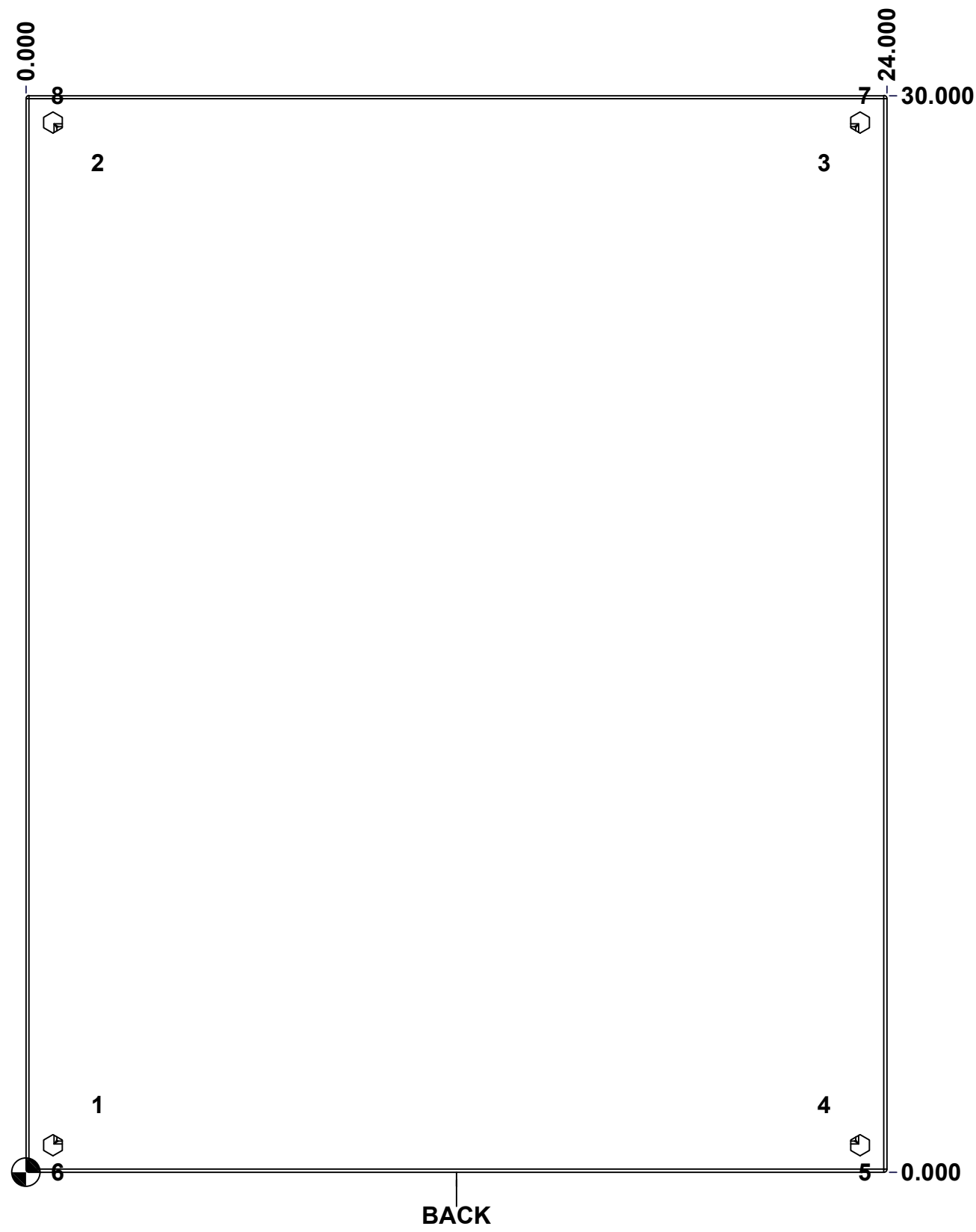

	Description	Status
	5412ESSW 30" x 24" x 12" Body	(NULL)
	Part Number Numéro Pièce	Rev.
<b>5412ESSW3024126THNOIPB 0</b>	<b>6</b>	<b>15</b>

This drawing is confidential and must not be reproduced or used without the consent of EXM

Ce dessin est confidentiel et ne doit pas être reproduit ou utilisé sans le consentement de EXM

No.	Revisions	Date	By/Par

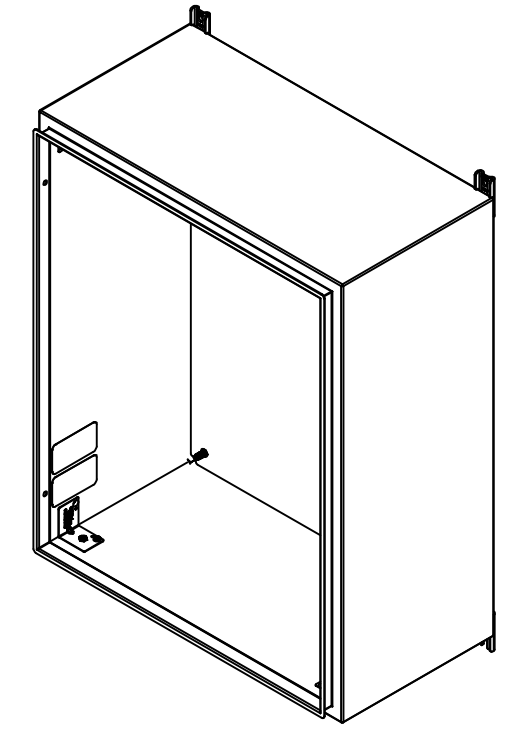

Isometric View



2	885ESMF4-FEET	0	885 ESMF4 Stainless Steel Mounting Foot
4	RIVET_NUT_SS_M10_FH_CE	0	Stainless Steel Rivet Nut M10 (Low Profile Close End)
4	STK-Q-06670	2	M10 x 16mm Stainless Steel Machine Screw
2	885ESMF4-FEET-A	0	885 ESMF4 Stainless Steel Mounting Foot (Opened Slot)
2	STK-S-00100	0	3.5" x 2" Silver Milar Flexcon Sticker
1	STK-K-70554	3	5412 ESTH Accessory Kit
1	5412ESSW3024126THNO IPI-RS	0	5412ESSW 30" x 24" Right Insulation
1	5412ESSW3024126THNO IPI-LS	0	5412ESSW 30" x 24" Left Insulation
1	5412ESSW3024126THNO IPI-BT	0	5412ESSW 30" x 24" Top and Bottom Insulation
1	5412ESSW3024126THNO IPI-TP	0	5412ESSW 30" x 24" Top and Bottom Insulation
1	5412ESSW3024126THNO IPI-B	0	5412ESSW 30" x 24" Back Insulation
4	STK-Q-16070	1	Stud M6 x 18mm Stainless steel
4	STK-Q-16020	1	Stud M8 x 35mm Stainless Steel
1	5412ESSW3024126THNO IPB-P	0	5412ESSW 30" x 24" x 12" Body Part

Tél: (450) 979-4373 Fax: (450) 979-4626 <a href="http://www.exmweb.com">www.exmweb.com</a>	Flatness Aplatissement Max 5.0mm
	Projection 
Customer Client	Date
Drawn By Dessiné Par BoxCad: BoxCad	Date 13-Jun-23
Material Matière	16 Ga Stainless Steel 316 (1.4mm)
Color Couleur	Unpainted Finish Fini Brushed
Description	Detail Rev.
5412ESSW 30" x 24" x 12" Body	
Part Number Numéro Pièce	Rev. 7
<b>5412ESSW3024126THNOIPB 0</b>	15

Qty	Part Number	Rev	Description
Parts List			

This drawing is confidential and must not be reproduced or used without the consent of EXM

Ce dessin est confidentiel et ne doit pas être reproduit ou utilisé sans le consentement de EXM

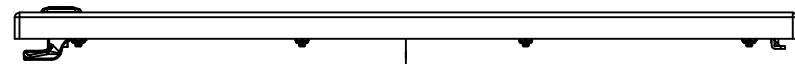

TOP

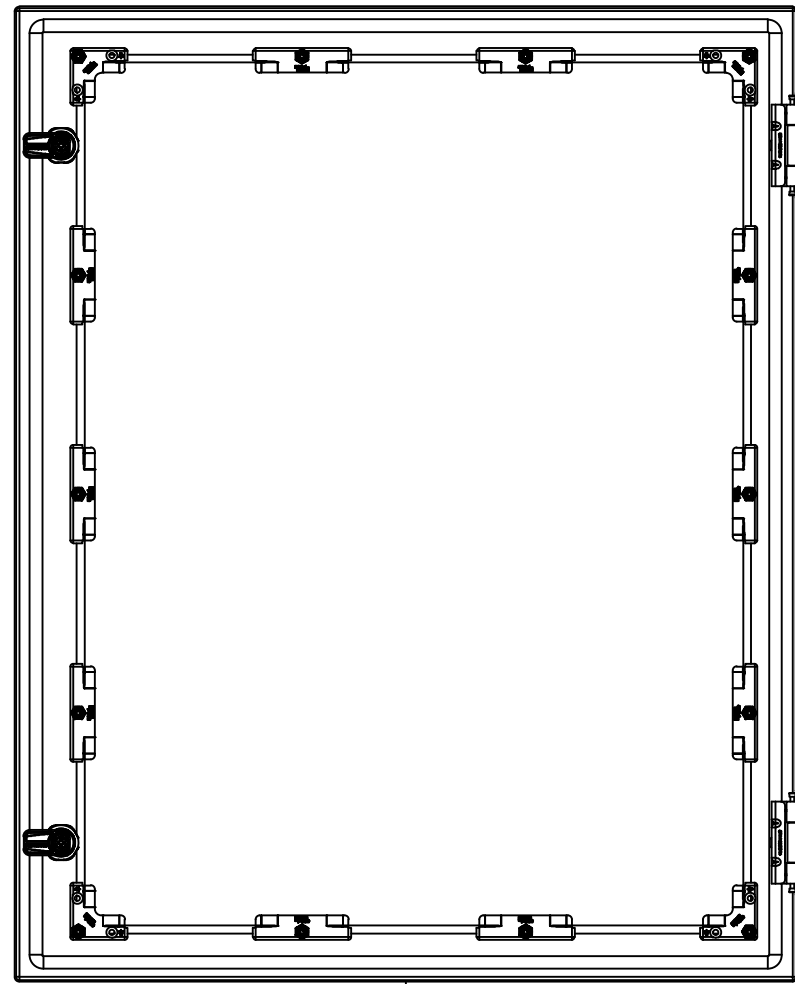

BACK

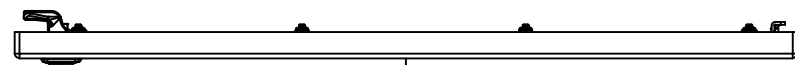

BOTTOM

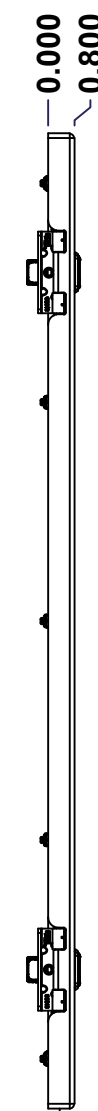

LEFT

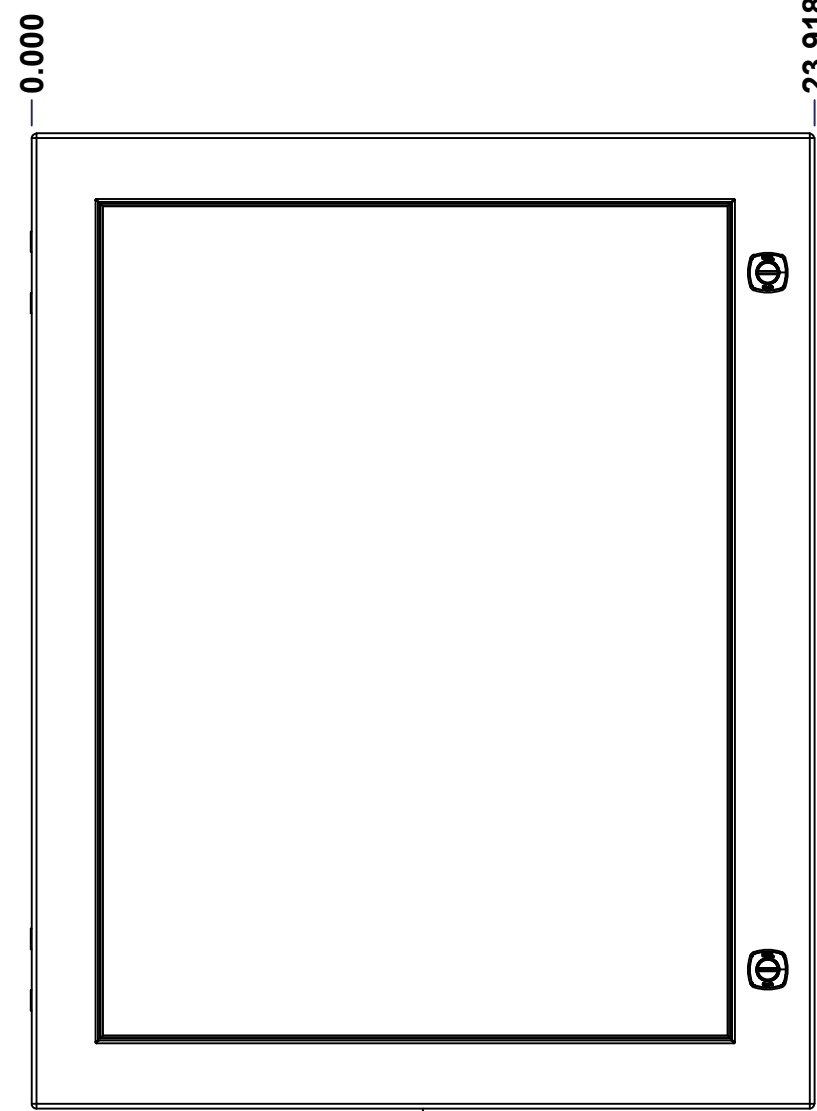

FRONT

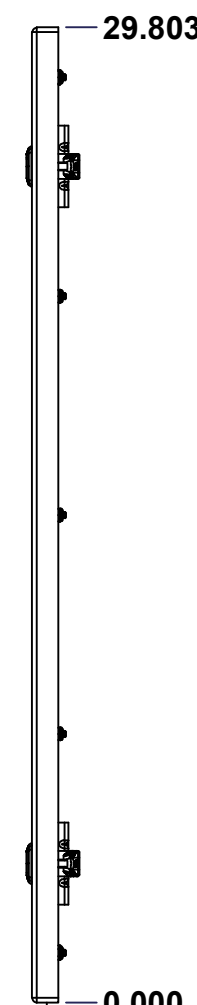

RIGHT

No.	Revisions	Date	By/Par

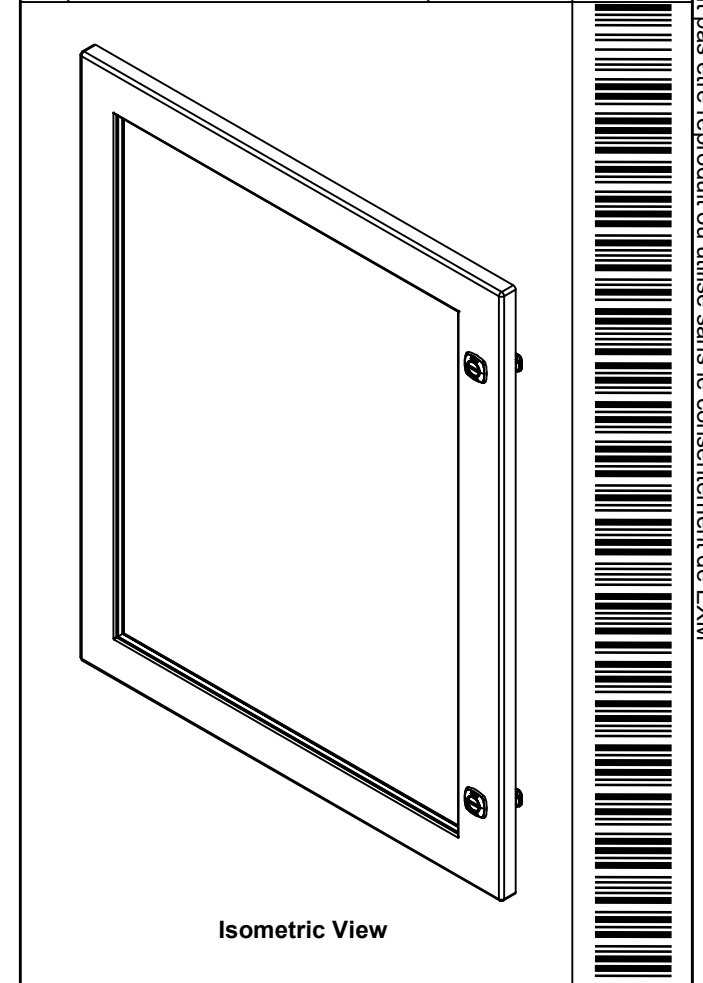

Isometric View



		Flatness / Aplatissement Max 5.0mm Projection	
Customer Client		Date	
Drawn By / Dessiné Par: BoxCad: BoxCad		Date: 13-Jun-23	
Material / Matière: 16 Ga Stainless Steel 316 (1.4mm)			
Color / Couleur: Unpainted		Finish / Fini: Brushed	
Description: 5412ESSW 30" x 24" Cover			Detail Rev.
Part Number / Numéro Pièce			Rev. 8

SEE BILL OF MATERIAL ON LAST PAGE 5412ESSW3024126THNOIPC 0 15



This drawing is confidential and must not be reproduced or used without the consent of EXM

Ce dessin est confidentiel et ne doit pas être reproduit ou utilisé sans le consentement de EXM

**STANDARD FEATURES ARE NOT LISTED IN THIS HOLE TABLE**

**HOLE TABLE - FRONT VIEW (CUSTOM FEATURE ONLY)**

CUT-OUT	XDIM	YDIM	DESCRIPTION
1	1.469	8.214	STUD M6 x 18mm (Inside)
2	21.968	8.214	STUD M6 x 18mm (Inside)
3	1.469	14.902	STUD M6 x 18mm (Inside)
4	21.968	14.902	STUD M6 x 18mm (Inside)
5	1.469	21.589	STUD M6 x 18mm (Inside)
6	21.968	21.589	STUD M6 x 18mm (Inside)
7	1.469	28.276	STUD M6 x 18mm (Inside)
8	1.469	1.527	STUD M6 x 18mm (Inside)
9	8.302	28.276	STUD M6 x 18mm (Inside)
10	8.302	1.527	STUD M6 x 18mm (Inside)
11	15.135	28.276	STUD M6 x 18mm (Inside)
12	15.135	1.527	STUD M6 x 18mm (Inside)
13	21.968	28.276	STUD M6 x 18mm (Inside)
14	21.968	1.527	STUD M6 x 18mm (Inside)
-----			
15	22.494	25.553	880 SCQ4-SLSS6
16	22.494	4.250	880 SCQ4-SLSS6

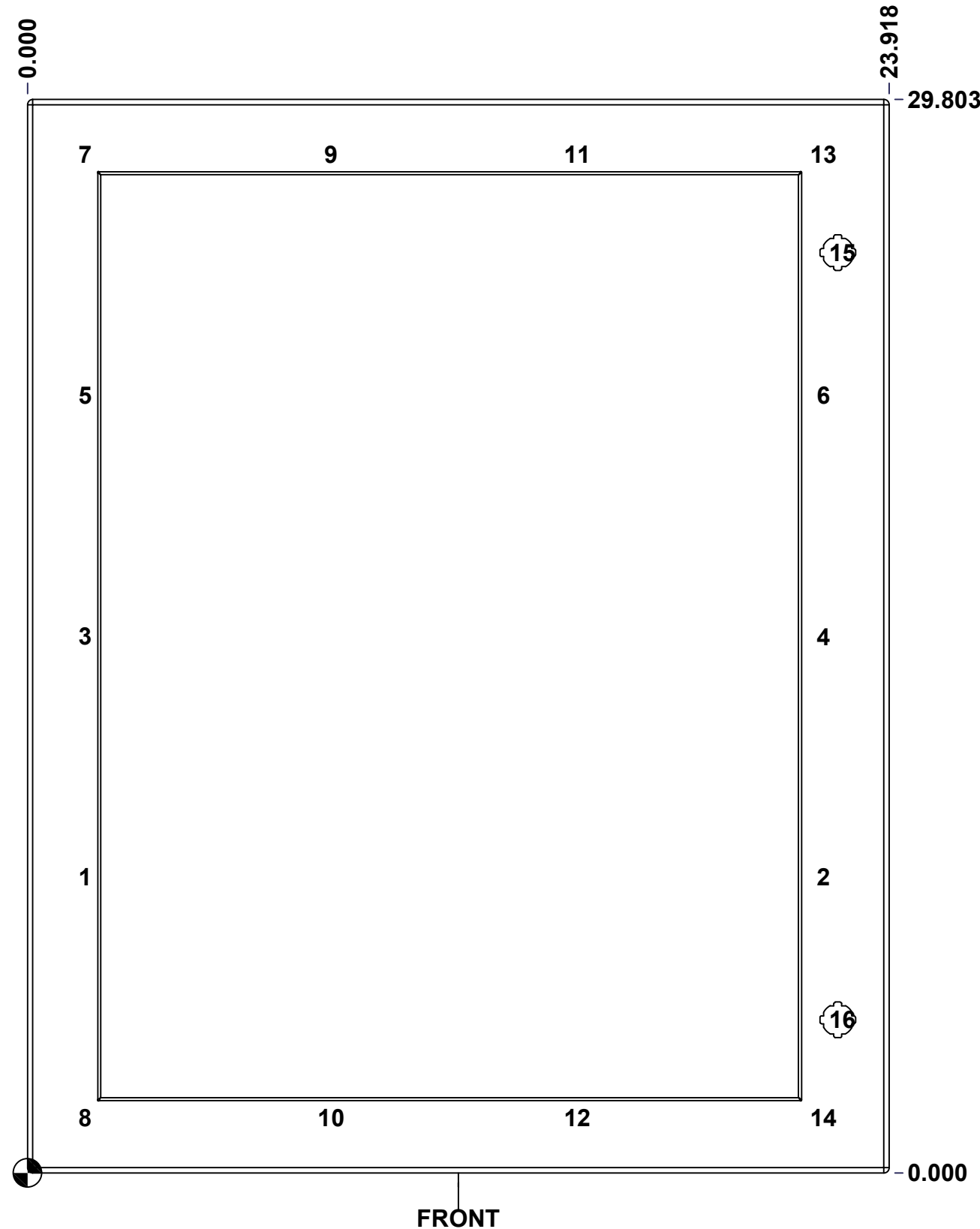

FRONT

	Description	Status
	5412ESSW 30" x 24" Cover	(NULL)
	Part Number	Rev.
	Numéro Pièce	9
	<b>5412ESSW3024126THNOIPC 0</b>	15

This drawing is confidential and must not be reproduced or used without the consent of EXM

Ce dessin est confidentiel et ne doit pas être reproduit ou utilisé sans le consentement de EXM

No.	Revisions	Date	By/Par

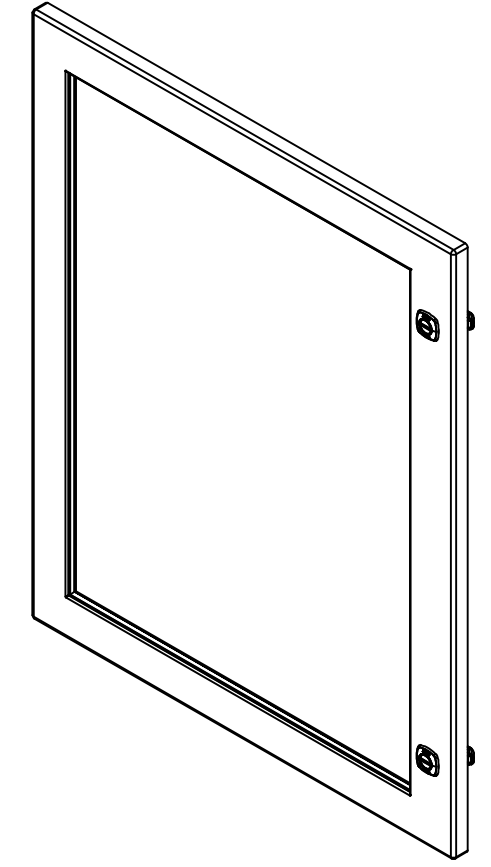

Isometric View

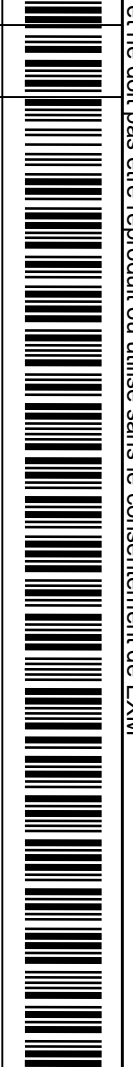

10	STK-Q-60701	2.1	880 WK - Lexan 1/4" Fixing Bracket
1	STK-A-60703	0	5412 ESW Lexan Bracket Kit
14	STK-Q-16053	1	Stud M6 x 23mm Stainless steel
1	STK-G-02710	0	880 HWKG - Windows Kit Gasket
1	5412ESSW3024126THNO IPLXG	0	5412ESSW 30" x 24" Lexan Gasket Part
1	5412ESSW3024126THNO IPLX	0	5412ESSW 26.375" x 20.125" Lexan Part
1	5412ESSW3024126THNO IPG	0	5412ESSW 30" x 24" Cover Gasket Part
1	5412ESSW3024126THNO IPC-P	0	5412ESSW 30" x 24" Cover Part
2	880 SCQ4-SLSS6	7	5412 ESS 1/4 Turn Lock
2	STK-A-33016	0	5412 ESS Bended Hinge (Body Part)
QTY	Part Number	Rev	Description



Tél: (450) 979-4373  
Fax: (450) 979-4626  
[www.exmweb.com](http://www.exmweb.com)

Flatness: ~~Aplatissement~~  
Max 5.0mm

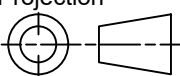
Projection 

Customer Client:   
Date:   
Drawn By / Dessiné Par: BoxCad: BoxCad  
Date: 13-Jun-23  
Material / Matière: 16 Ga Stainless Steel 316 (1.4mm)  
Color / Couleur: Unpainted  
Finish / Fini: Brushed  
Description: 5412ESSW 30" x 24" Cover  
Detail Rev.   
Part Number / Numéro Pièce: **5412ESSW3024126THNOIPC**  
Rev. 10

This drawing is confidential and must not be reproduced or used without the consent of EXM

Ce dessin est confidentiel et ne doit pas être reproduit ou utilisé sans le consentement de EXM

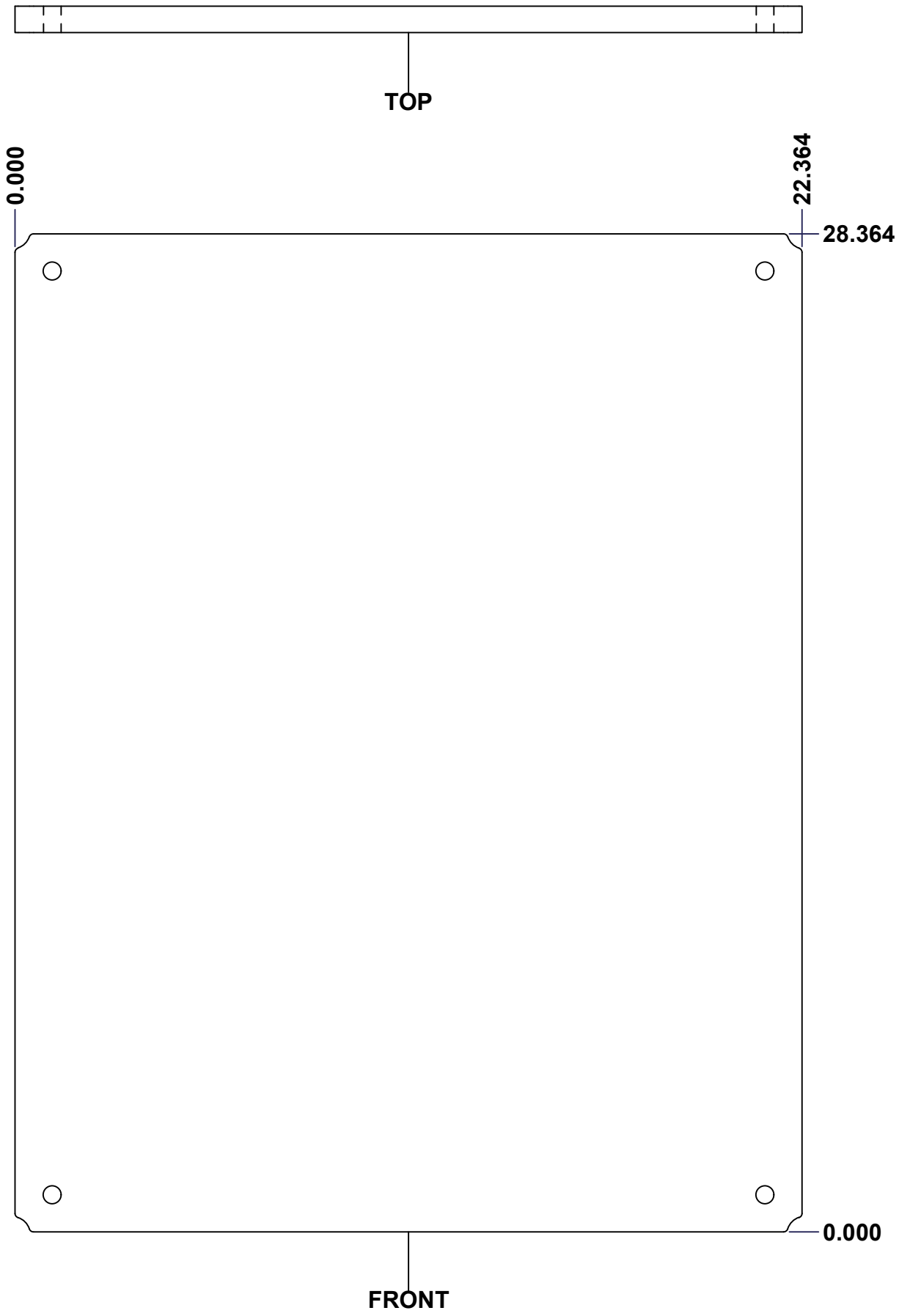

No.	Revisions	Date	By/Par

**Isometric View**

<p>Tél: (450) 979-4373                  Fax: (450) 979-4626  <a href="http://www.exmweb.com">www.exmweb.com</a></p>		Flatness Aplatissement
		Max 3.0mm
Projection		
Customer Client	Date	
Drawn By Dessiné Par	BoxCad: Patrick Deschenes	Date 23-Jan-07
Material Matière	Polyisocyanurate	
Color Couleur	Aluminum	Finish Fini N/A
Description	Detail Rev.	
5412ESSW 30" x 24" Back Insulation		
Part Number Numéro Pièce	Rev.	11
SEE BILL OF MATERIAL ON LAST PAGE 5412ESSW3024126THNOIPI-B 0		15

This drawing is confidential and must not be reproduced or used without the consent of EXM

Ce dessin est confidentiel et ne doit pas être reproduit ou utilisé sans le consentement de EXM

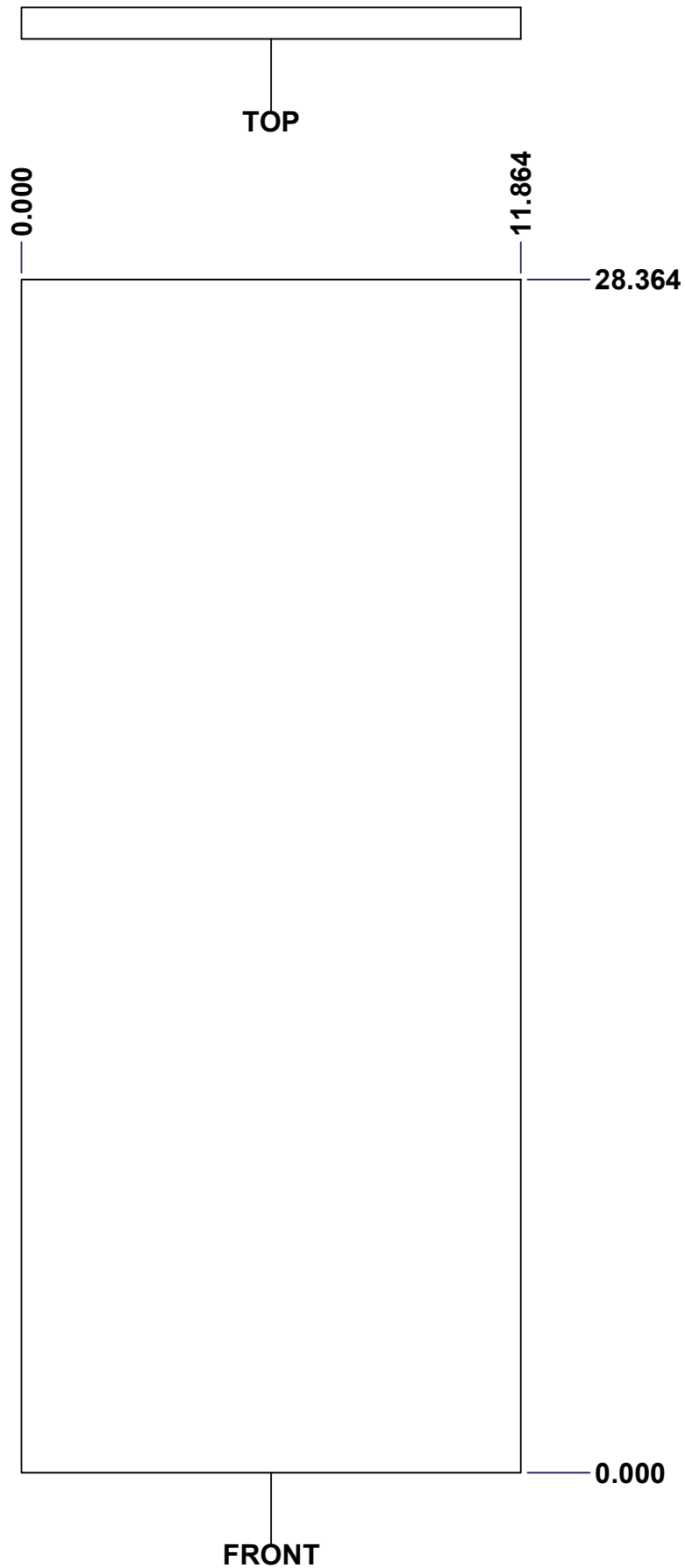

No.	Revisions	Date	By/Par

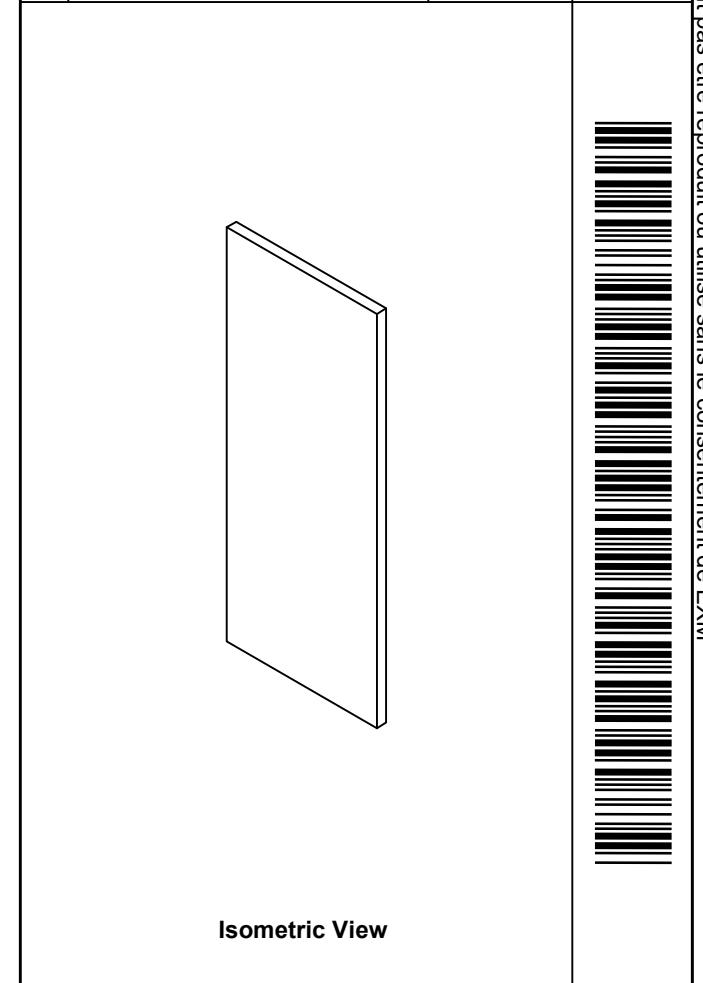

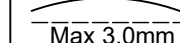
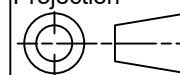
 Tél: (450) 979-4373 Fax: (450) 979-4626 <a href="http://www.exmweb.com">www.exmweb.com</a>		Flatness Aplatissement  Max 3.0mm
Customer Client		Date
Drawn By Dessiné Par	BoxCad: Patrick Deschenes	Date 23-Jan-07
Material Matière Polyisocyanurate		
Color Couleur Aluminum	Finish Fini N/A	Projection 
Description 5412ESSW 30" x 24" Left Insulation		Detail Rev.
Part Number Numéro Pièce 5412ESSW3024126THNOIP-L		Rev. 12

SEE BILL OF MATERIAL ON LAST PAGE 5412ESSW3024126THNOIP-L S0

This drawing is confidential and must not be reproduced or used without the consent of EXM

Ce dessin est confidentiel et ne doit pas être reproduit ou utilisé sans le consentement de EXM

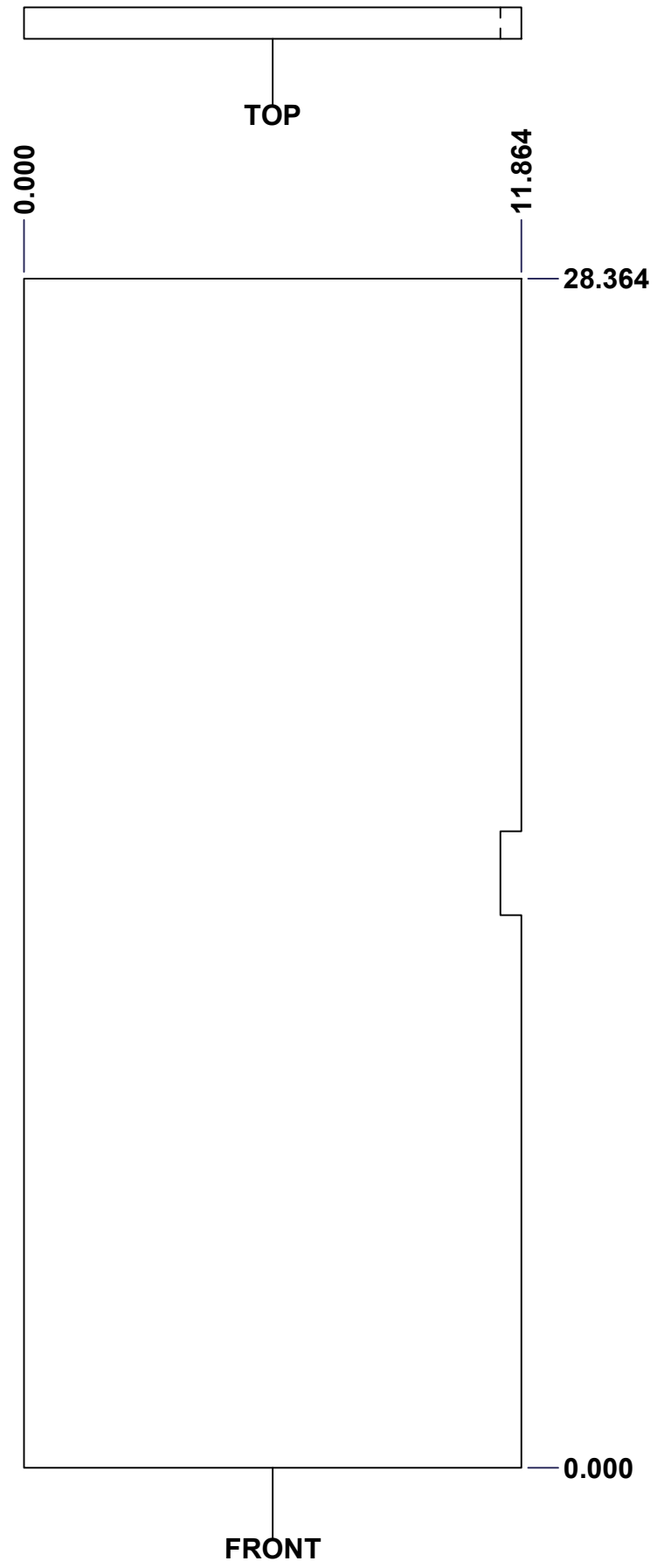

No.	Revisions	Date	By/Par

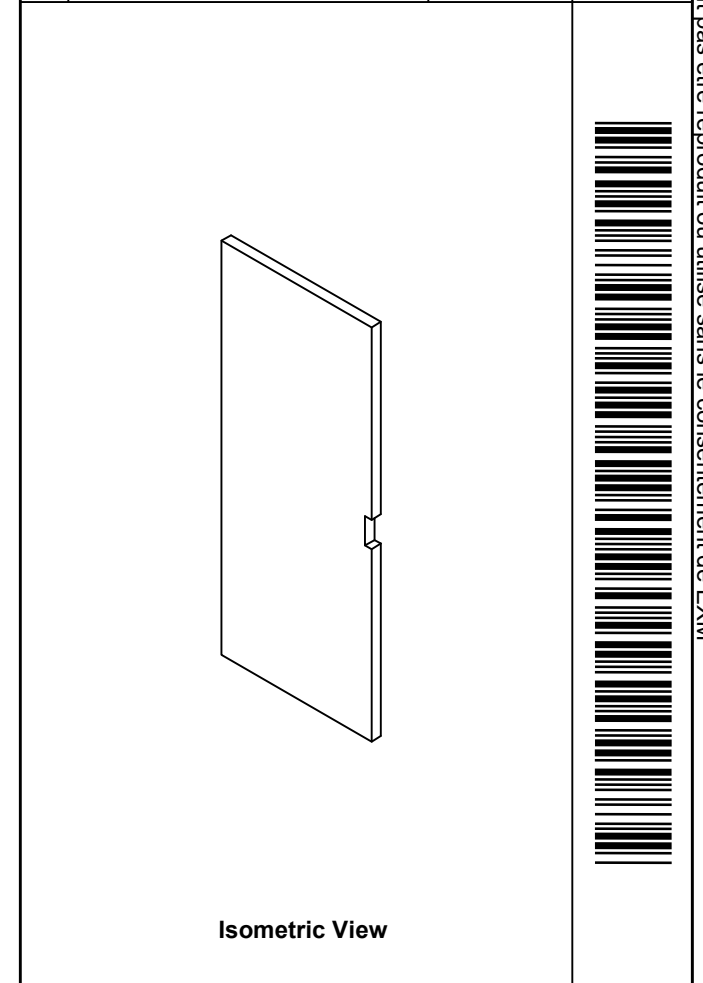

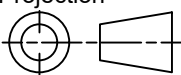
 Tél: (450) 979-4373 Fax: (450) 979-4626 <a href="http://www.exmweb.com">www.exmweb.com</a>		Flatness Aplatissement Max 3.0mm
Customer Client		Date
Drawn By Dessiné Par	BoxCad: Patrick Deschenes	Date 23-Jan-07
Material Matière Polyisocyanurate		
Color Couleur Aluminum	Finish Fini N/A	Projection 
Description 5412ESSW 30" x 24" Right Insulation		Detail Rev.
Part Number Numéro Pièce		Rev. 13

**SEE BILL OF MATERIAL ON LAST PAGE 5412ESSW3024126THNOIPI-RS0**

This drawing is confidential and must not be reproduced or used without the consent of EXM

Ce dessin est confidentiel et ne doit pas être reproduit ou utilisé sans le consentement de EXM

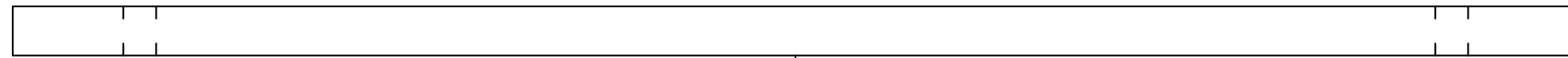

TOP



FRONT

0.000  
0.750



RIGHT

No.	Revisions	Date	By/Par

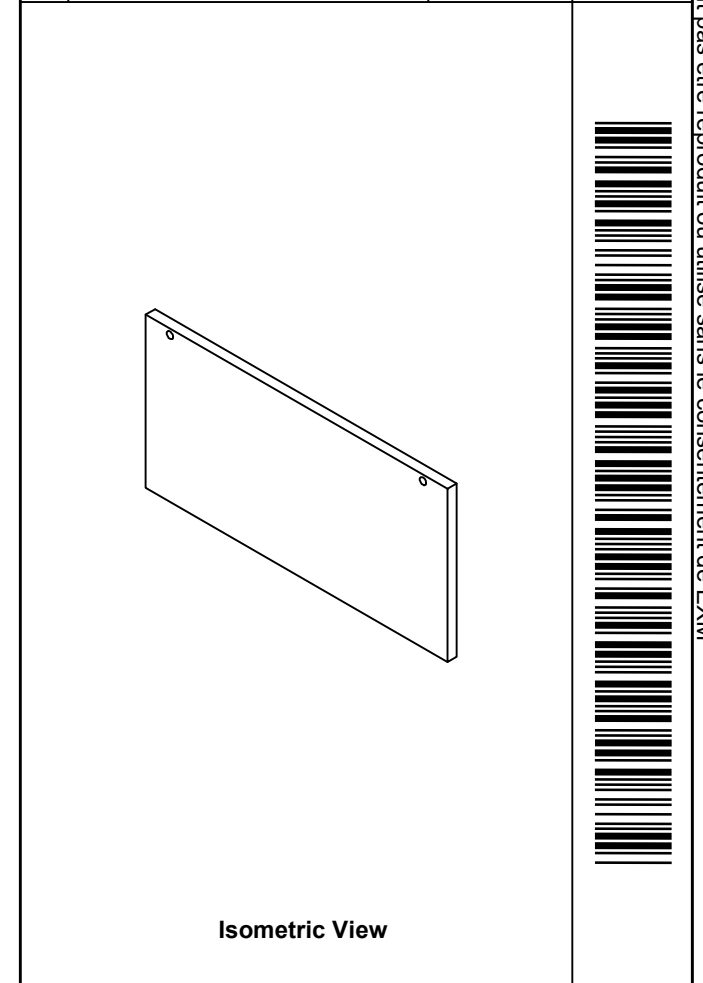

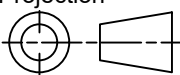
 Tél: (450) 979-4373 Fax: (450) 979-4626 <a href="http://www.exmweb.com">www.exmweb.com</a>		Flatness Aplatissement Max 3.0mm
Projection 		Date 23-Jan-07
Customer Client	Date	
Drawn By Dessiné Par	BoxCad: Patrick Deschenes	Date 23-Jan-07
Material Matière	Polyisocyanurate	
Color Couleur	Aluminum	Finish Fini N/A
Description	Detail Rev.	
5412ESSW 30" x 24" Top and Bottom Insulation		
Part Number Numéro Pièce	Rev.	14
5412ESSW3024126THNOIPI-TP0		15

SEE BILL OF MATERIAL ON LAST PAGE

This drawing is confidential and must not be reproduced or used without the consent of EXM

Ce dessin est confidentiel et ne doit pas être reproduit ou utilisé sans le consentement de EXM

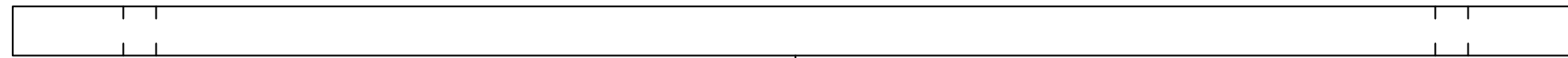

TOP



FRONT

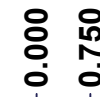

RIGHT

No.	Revisions	Date	By/Par

**Isometric View**

Tél: (450) 979-4373 Fax: (450) 979-4626 <a href="http://www.exmweb.com">www.exmweb.com</a>		Flatness Aplatissement	
		Max 3.0mm	
Customer Client		Date	
Drawn By Dessiné Par		Date	
Material Matière		Polyisocyanurate	
Color Couleur		Aluminum	Finish Fini
Description		Detail Rev.	
5412ESSW 30" x 24" Top and Bottom Insulation			
Part Number Numéro Pièce		Rev.	15
SEE BILL OF MATERIAL ON LAST PAGE		15	