

This drawing is confidential and must not be reproduced or used without the consent of EXM

Ce dessin est confidentiel et ne doit pas être reproduit ou utilisé sans le consentement de EXM

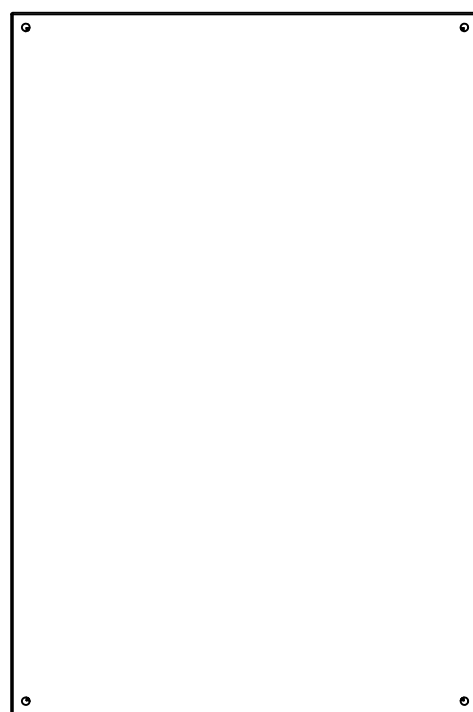

TOP



BACK

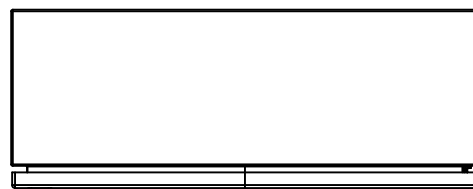

BOTTOM

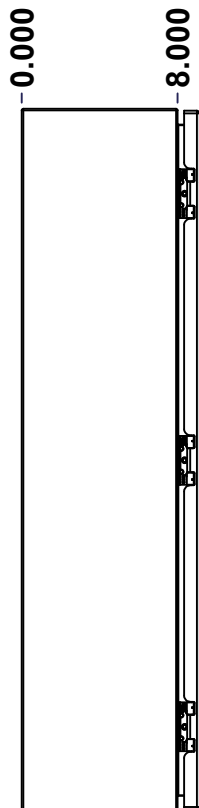

LEFT

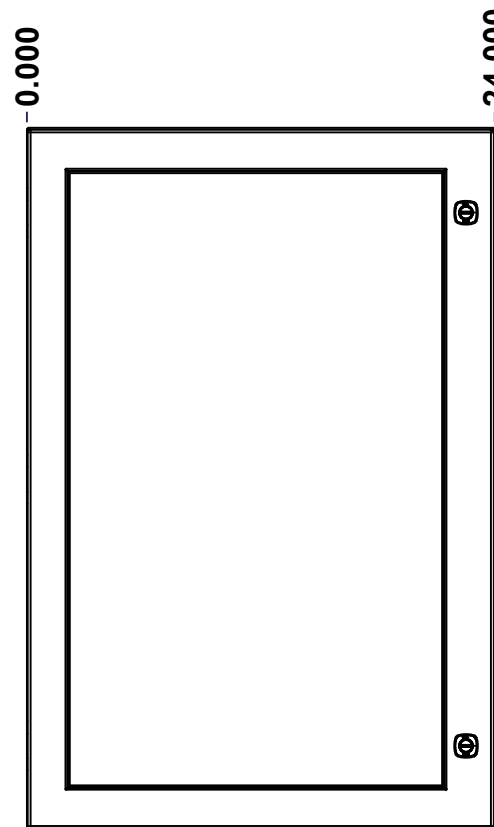

FRONT

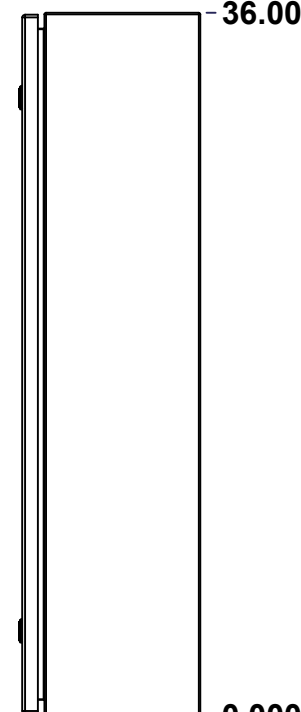

RIGHT

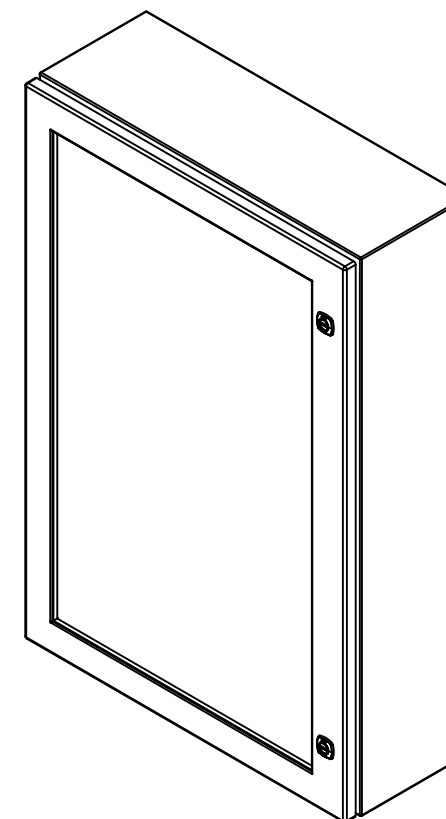

Isometric View



**GRAIN DIRECTION:
TOP/BOTTOM: HORIZONTAL
LEFT/RIGHT/BACK/FRONT: VERTICAL**

SEE BILL OF MATERIAL ON LAST PAGE

No.	Revisions	Date	By/Par

 Tél: (450) 979-4373 Fax: (450) 979-4626 www.exmweb.com		Flatness Aplatissement Max 3.0mm Projection 
Customer Client	Date	Date
Drawn By Dessiné Par	BoxCad: BoxCad	04-Jul-13
Material Matière	16 Ga Stainless Steel 304 (1.4mm)	
Color Couleur	Unpainted	Finish Fini: Brushed
Description	Detail Rev.	
5412ESSW 36" x 24" x 8" Assembly		
Part Number Numéro Pièce	Rev.	1
5412ESSW362408	0	2

This drawing is confidential and must not be reproduced or used without the consent of EXM

Ce dessin est confidentiel et ne doit pas être reproduit ou utilisé sans le consentement de EXM

NOTE	
ITEM	DESCRIPTION
1	NEMA 4X Enclosure
2	C/W Standard ground studs on box and cover
3	W/O Standard door stiffener
4	C/W Standard inner panel (Included)
5	C/W Standard inner panel mounting studs

No.	Revisions	Date	By/Par

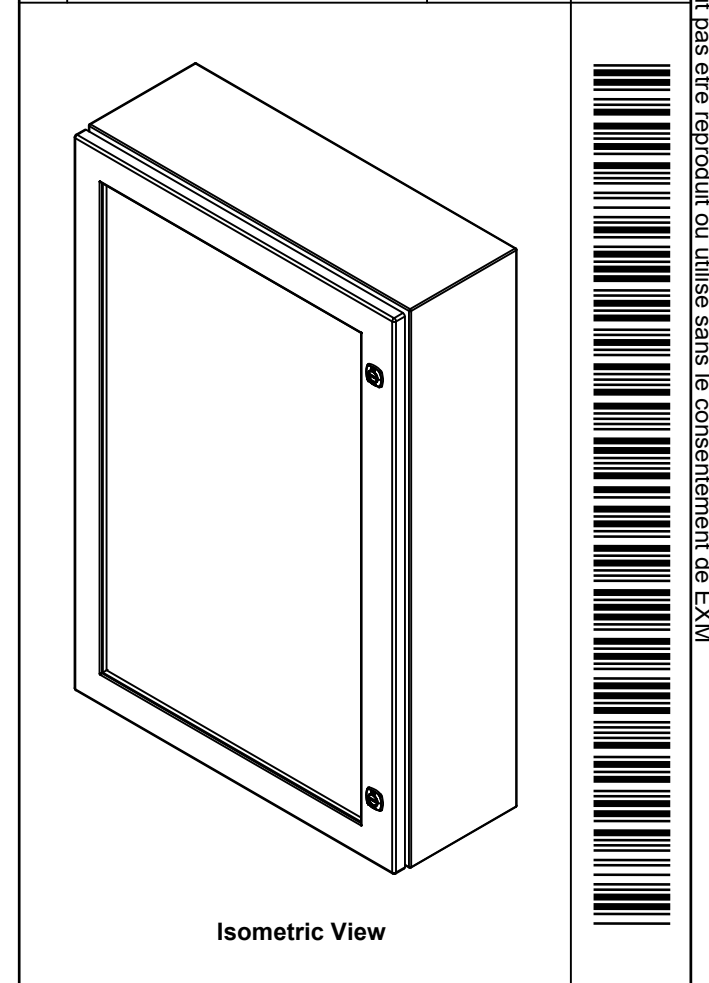

EXM
www.exm.com

Tél: (450) 979-4373
Fax: (450) 979-4626
www.exmweb.com

Flatness
Aplatissement
Max 3.0mm

Projection

Customer Client	Date
Drawn By Dessiné Par BoxCad: BoxCad	Date 04-Jul-13
Material Matière	16 Ga Stainless Steel 304 (1.4mm)

Color Couleur	Unpainted	Finish Fini	Brushed
Description	5412ESSW 36" x 24" x 8" Assembly		
Part Number Numéro Pièce	5412ESSW362408		Rev. 2
			0

1	880 PP	6	Self Adhesive Print Pocket
1	STK-K-01800	5	5412 ES Accessory Kit
1	881 SP3624G	0	881 SP - Inner Panel
1	5412ESSW362408C	0	5412ESSW 36" x 24" Cover
6	STK-Q-07310	2	Flange Lock Nut M8
6	STK-Q-07610	8	M8 Plastic Spacer 22.2mm
1	5412ESSW362408B	0	5412ESSW 36" x 24" x 8" Body
3	STK-Q-04051-07	8	M6 x 7mm Stainless Steel Hexagon Socket Head Machine Screw with Nyseal
Qty	Part Number	Rev	Description
Parts List			

PACKING		
ITEM	QTY	DESCRIPTION
Cardboard sleeve	2	Top and Bottom
Cardboard strip	2	Between back of enclosure and inner panel
Plastic bag	1	To protect cover surface and inside gasket
Plastic strap - Black	2	To Squeeze the 2 cardboard sleeve together
Packaging label	1	White label with product number

This drawing is confidential and must not be reproduced or used without the consent of EXM

Ce dessin est confidentiel et ne doit pas être reproduit ou utilisé sans le consentement de EXM

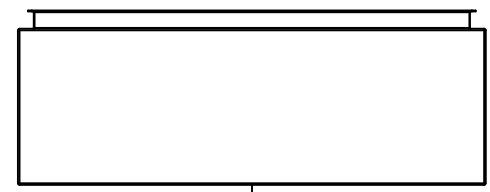

TOP

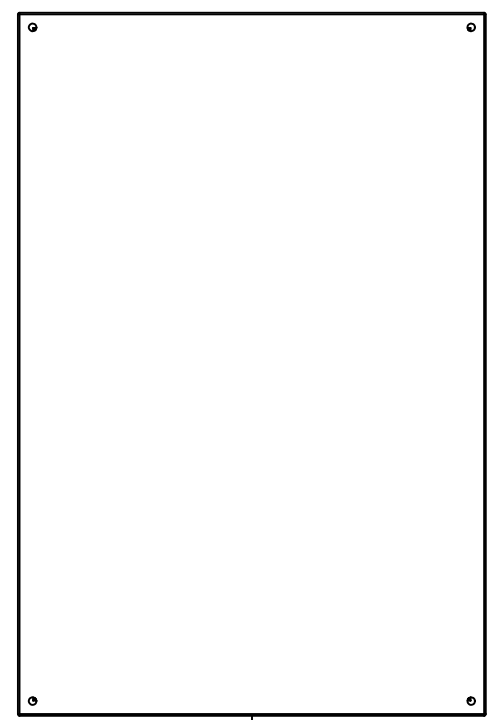

BACK

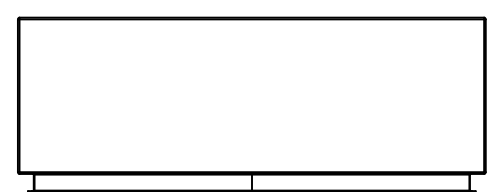

BOTTOM

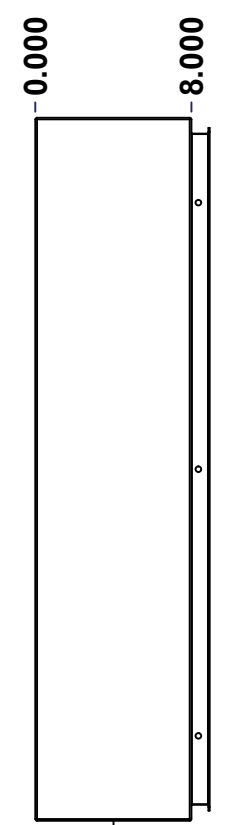

LEFT

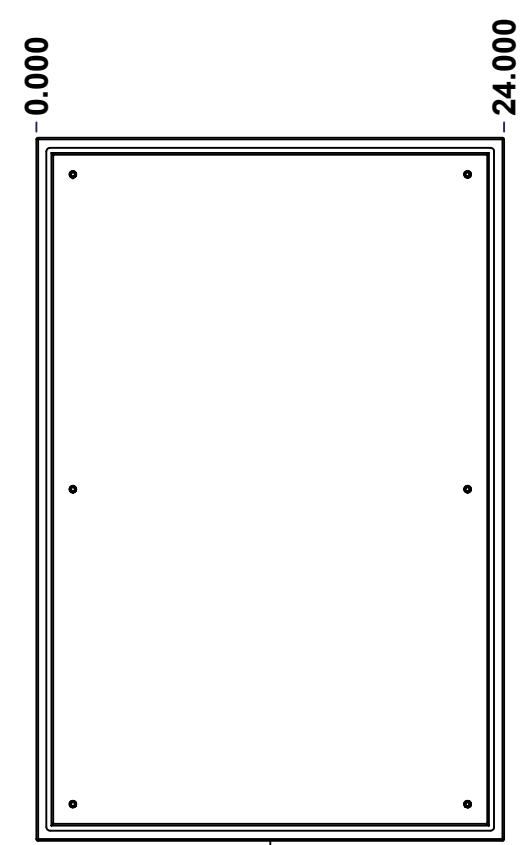

FRONT

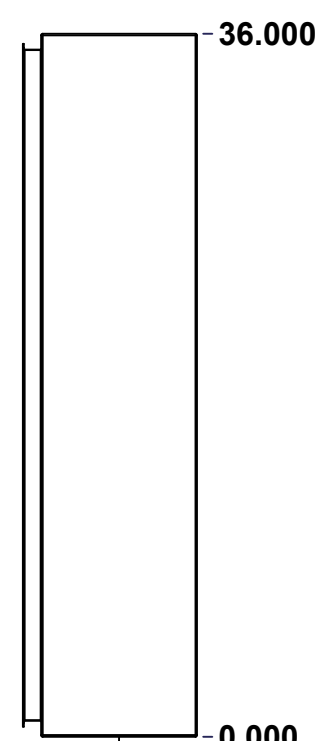

RIGHT

No.	Revisions	Date	By/Par

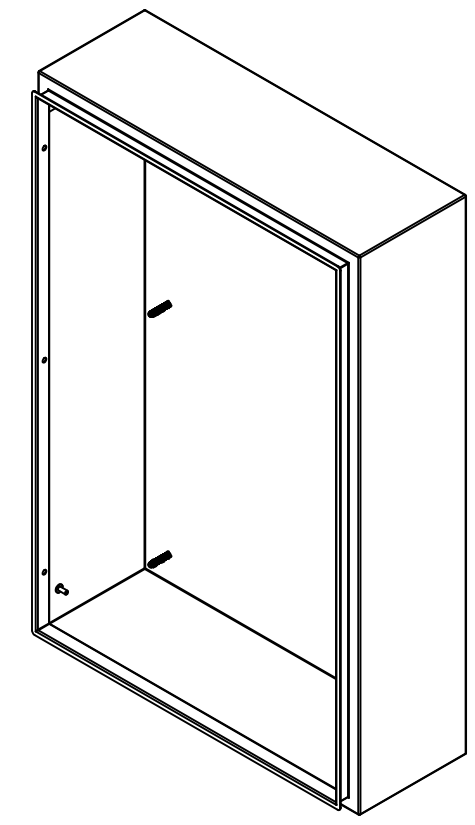

Isometric View

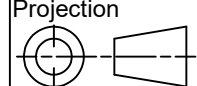

 Tél: (450) 979-4373 Fax: (450) 979-4626 www.exmweb.com		Flatness Aplatissement Max 3.0mm Projection 
Customer Client	Date	
Drawn By Dessiné Par	BoxCad: BoxCad	Date 04-Jul-13
Material Matière	16 Ga Stainless Steel 304 (1.4mm)	
Color Couleur	Unpainted	Finish Fini Brushed
Description	Detail Rev.	
5412ESSW 36" x 24" x 8" Body		
Part Number Numéro Pièce	Rev. 0	1 / 7
5412ESSW362408B		

SEE BILL OF MATERIAL ON LAST PAGE

This drawing is confidential and must not be reproduced or used without the consent of EXM

Ce dessin est confidentiel et ne doit pas être reproduit ou utilisé sans le consentement de EXM

STANDARD FEATURES ARE NOT LISTED IN THIS HOLE TABLE			
HOLE TABLE - LEFT VIEW (CUSTOM FEATURE ONLY)			
CUT-OUT	XDIM	YDIM	DESCRIPTION
1	6.500	2.000	GND STUD M6 x 16mm (Inside)
2	6.000	34.000	LABEL_EXM (Inside)

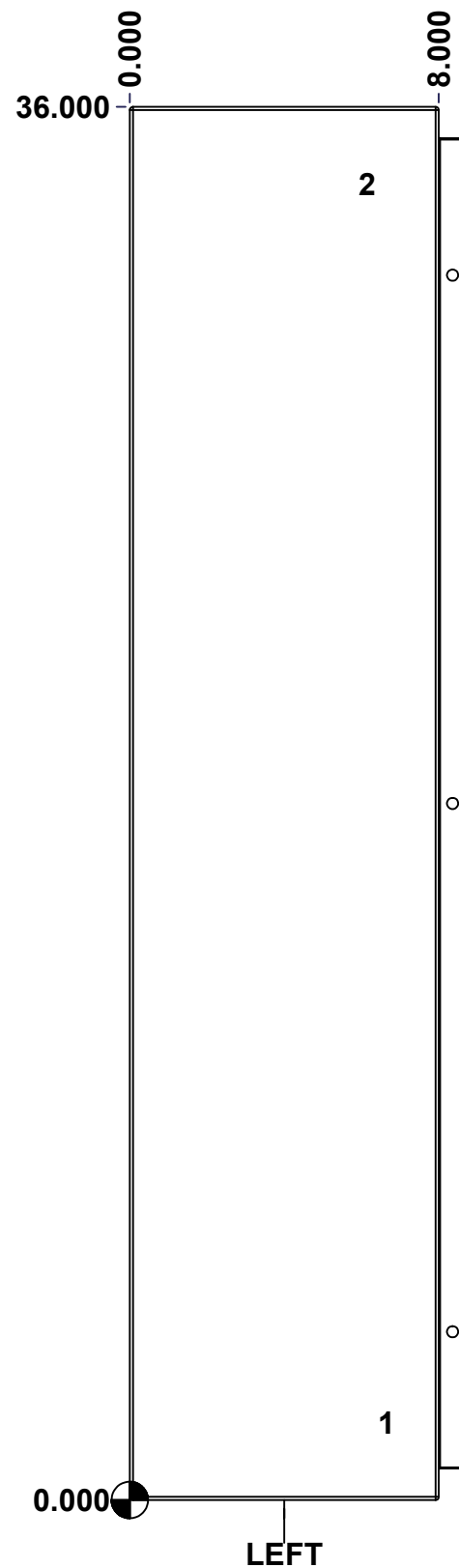

	Description	Status	
	5412ESSW 36" x 24" x 8" Body		
	Part Number Numéro Pièce	Rev.	
	5412ESSW362408B	0	5 / 7

This drawing is confidential and must not be reproduced or used without the consent of EXM

Ce dessin est confidentiel et ne doit pas être reproduit ou utilisé sans le consentement de EXM

STANDARD FEATURES ARE NOT LISTED IN THIS HOLE TABLE

HOLE TABLE - BACK VIEW (CUSTOM FEATURE ONLY)

CUT-OUT	XDIM	YDIM	DESCRIPTION
1	1.875	1.875	IP STUD M8 x 35mm (Inside)
2	1.875	34.125	IP STUD M8 x 35mm (Inside)
3	22.125	34.125	IP STUD M8 x 35mm (Inside)
4	22.125	1.875	IP STUD M8 x 35mm (Inside)
5	1.875	18.000	IP STUD M8 x 35mm (Inside)
6	22.125	18.000	IP STUD M8 x 35mm (Inside)

7	23.250	0.750	RND Ø0.390
8	23.250	35.250	RND Ø0.390
9	0.750	35.250	RND Ø0.390
10	0.750	0.750	RND Ø0.390

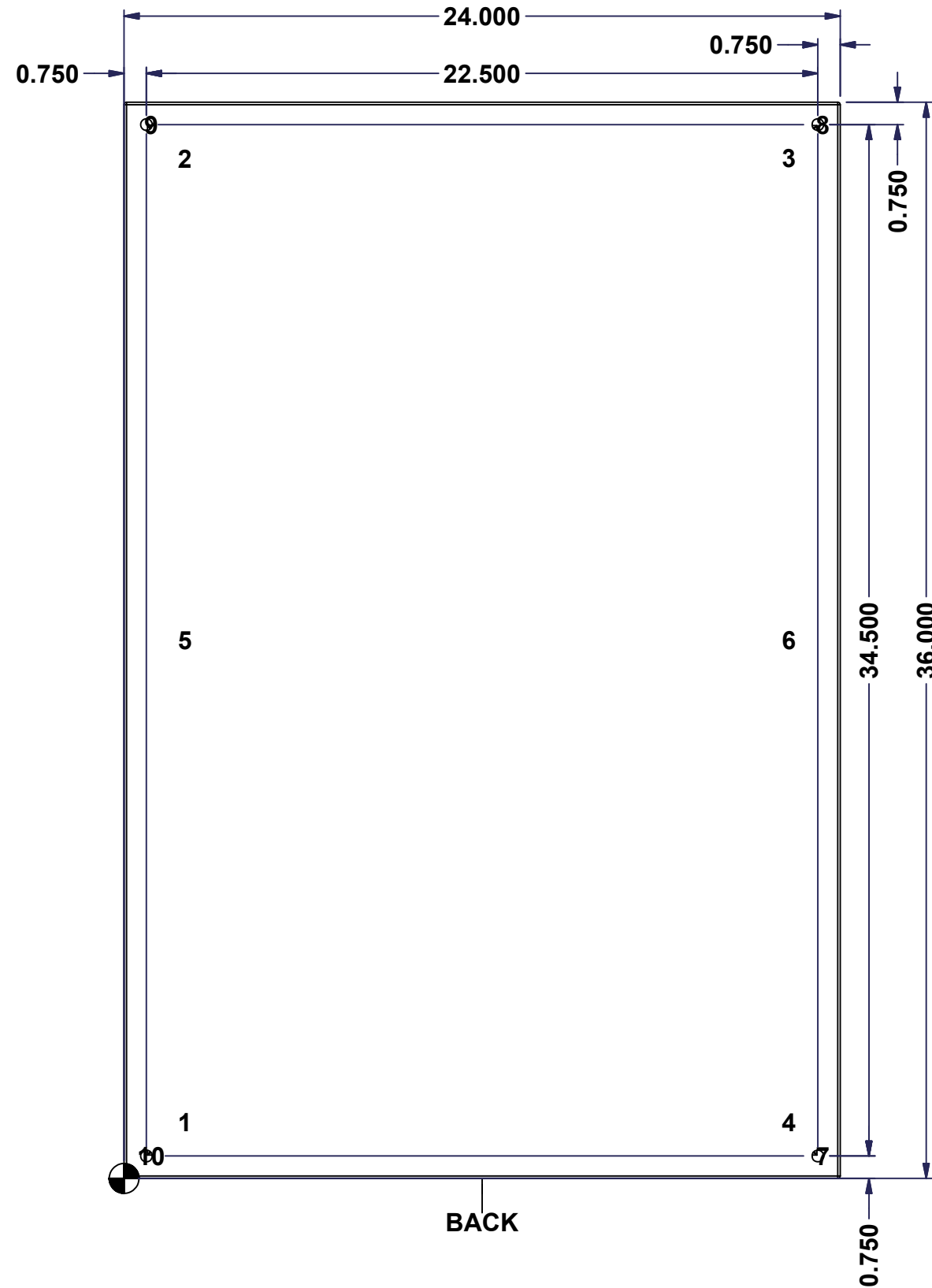

BACK



	Description		Status
	5412ESSW 36" x 24" x 8" Body		
	Part Number Numéro Pièce		Rev.
	5412ESSW362408B		6
			7

This drawing is confidential and must not be reproduced or used without the consent of EXM

Ce dessin est confidentiel et ne doit pas être reproduit ou utilisé sans le consentement de EXM

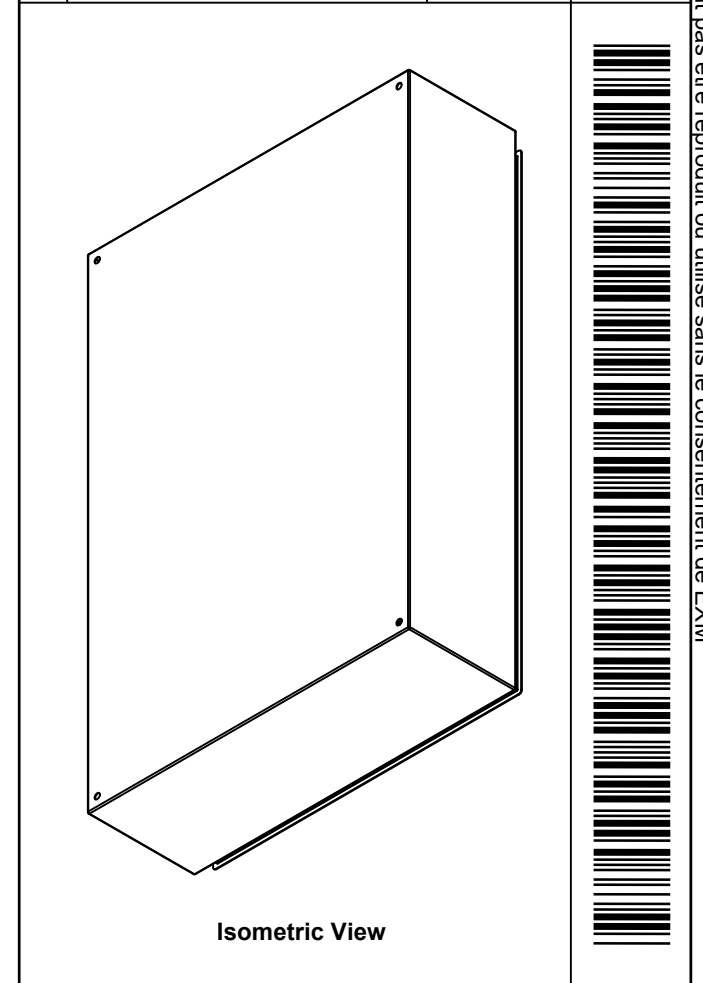
No.	Revisions	Date	By/Par

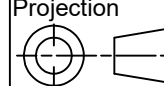

 Tél: (450) 979-4373 Fax: (450) 979-4626 www.exmweb.com		Flatness Aplatissement  Max 3.0mm Projection 
Customer Client	Date	
Drawn By Dessiné Par	BoxCad: BoxCad	Date 04-Jul-13
Material Matière	16 Ga Stainless Steel 304 (1.4mm)	
Color Couleur	Unpainted	Finish Fini Brushed
Description		Detail Rev.
5412ESSW 36" x 24" x 8" Body		
Part Number Numéro Pièce	Rev.	7
5412ESSW362408B	0	7

Qty	Part Number	Rev	Description
1	STK-S-00100	0	3.5" x 2" Silver Milar Flexcon Sticker
1	STK-Q-16085	0	Ground Stud M6 x 16mm Stainless Steel
6	STK-Q-16020	1	Stud M8 x 35mm Stainless Steel
1	5412ESSW362408B-P	0	5412ESSW 36" x 24" x 8" Body Part
Parts List			

This drawing is confidential and must not be reproduced or used without the consent of EXM

Ce dessin est confidentiel et ne doit pas être reproduit ou utilisé sans le consentement de EXM

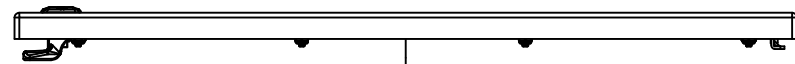

TOP

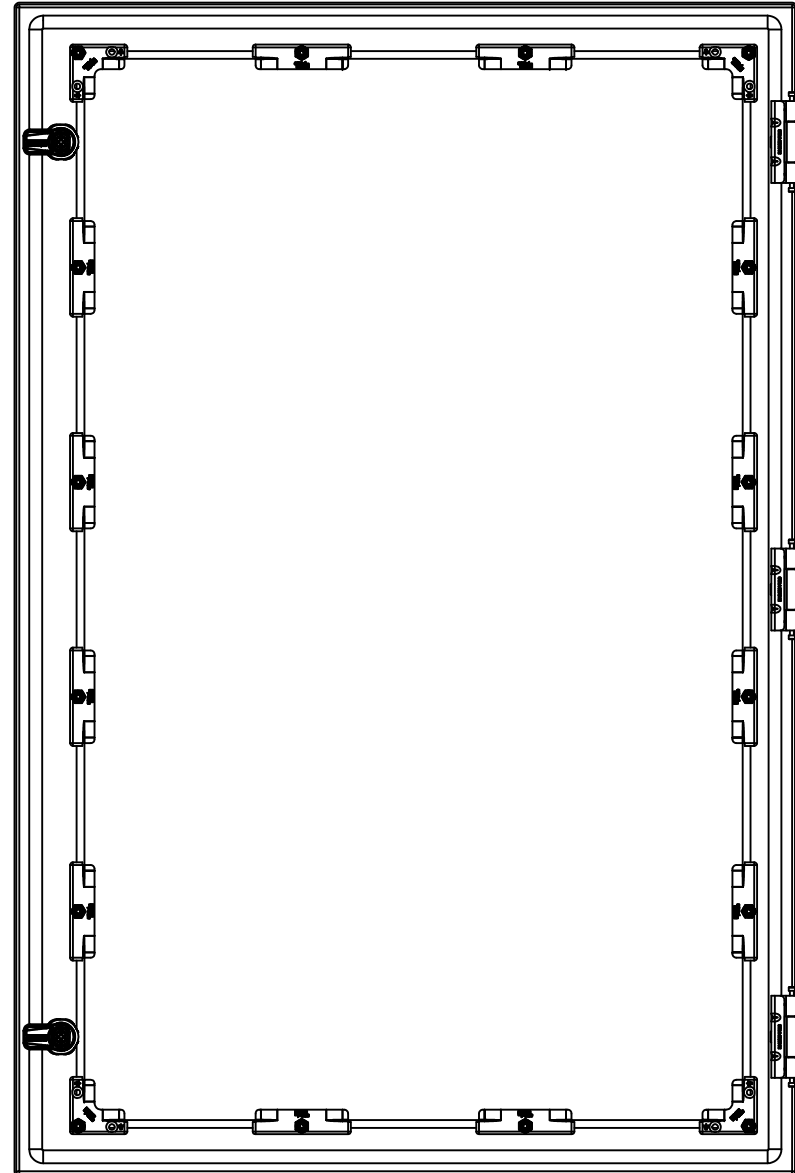

BACK

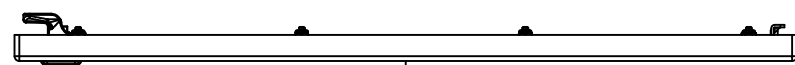

BOTTOM

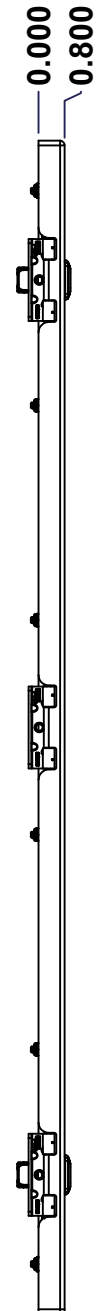

LEFT

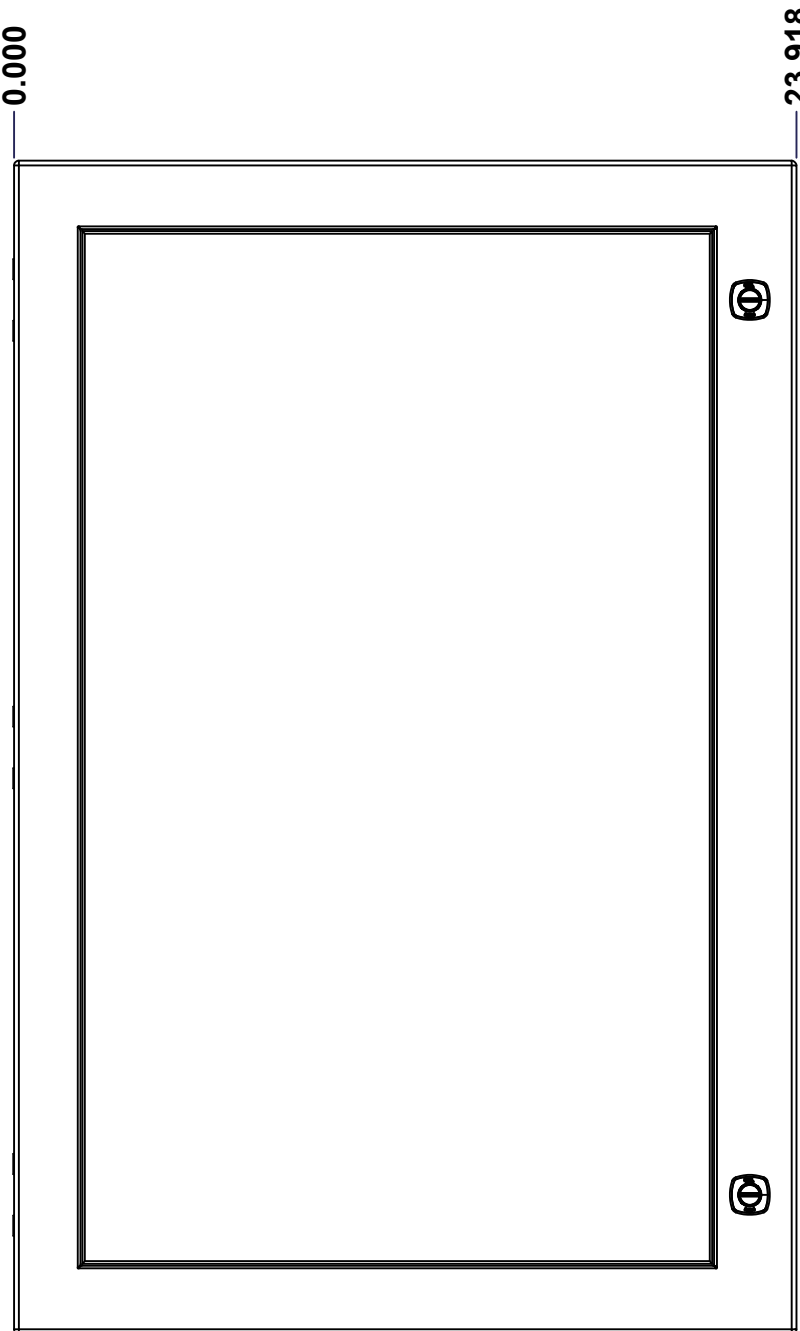

FRONT

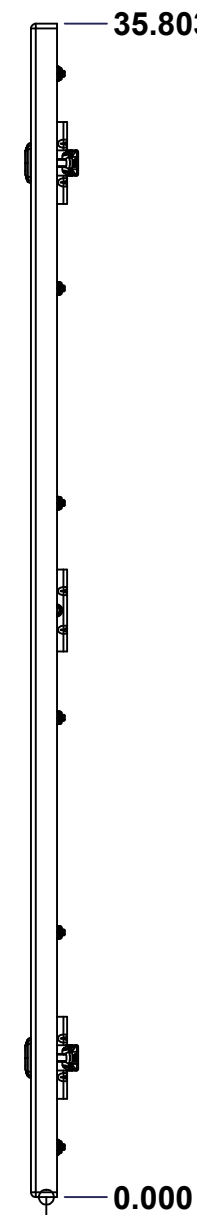

RIGHT

No.	Revisions	Date	By/Par

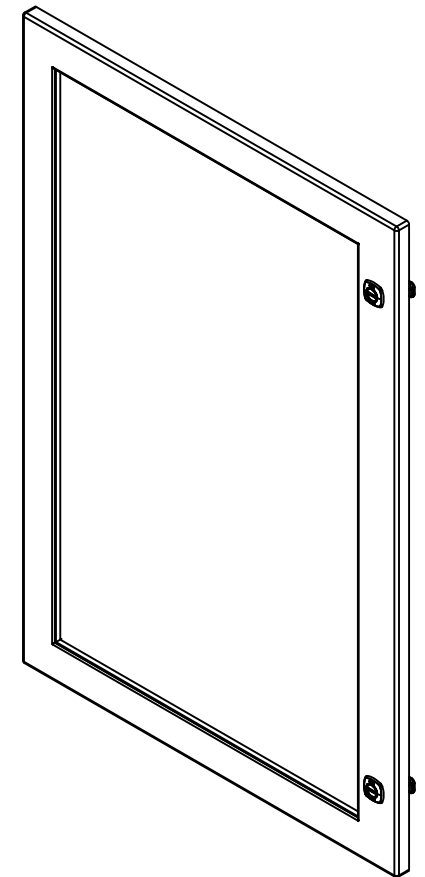

Isometric View



Tél: (450) 979-4373
 Fax: (450) 979-4626
www.exmweb.com

Flatness
Aplatissement
Max 3.0mm
Projection

Customer Client	Date
Drawn By Dessiné Par BoxCad: BoxCad	Date 04-Jul-13
Material Matière 16 Ga Stainless Steel 304 (1.4mm)	
Color Couleur Unpainted	Finish Fini Brushed
Description 5412ESSW 36" x 24" Cover	Detail Rev.
Part Number Numéro Pièce 5412ESSW362408C	Rev. 1 0 3

SEE BILL OF MATERIAL ON LAST PAGE

This drawing is confidential and must not be reproduced or used without the consent of EXM

Ce dessin est confidentiel et ne doit pas être reproduit ou utilisé sans le consentement de EXM

STANDARD FEATURES ARE NOT LISTED IN THIS HOLE TABLE

HOLE TABLE - FRONT VIEW (CUSTOM FEATURE ONLY)

CUT-OUT	XDIM	YDIM	DESCRIPTION
1	1.469	8.077	STUD M6 x 18mm (Inside)
2	21.968	8.077	STUD M6 x 18mm (Inside)
3	1.469	14.627	STUD M6 x 18mm (Inside)
4	21.968	14.627	STUD M6 x 18mm (Inside)
5	1.469	21.176	STUD M6 x 18mm (Inside)
6	21.968	21.176	STUD M6 x 18mm (Inside)
7	1.469	27.726	STUD M6 x 18mm (Inside)
8	21.968	27.726	STUD M6 x 18mm (Inside)
9	1.469	34.276	STUD M6 x 18mm (Inside)
10	1.469	1.527	STUD M6 x 18mm (Inside)
11	8.302	34.276	STUD M6 x 18mm (Inside)
12	8.302	1.527	STUD M6 x 18mm (Inside)
13	15.135	34.276	STUD M6 x 18mm (Inside)
14	15.135	1.527	STUD M6 x 18mm (Inside)
15	21.968	34.276	STUD M6 x 18mm (Inside)
16	21.968	1.527	STUD M6 x 18mm (Inside)

17	22.494	31.553	LOCK 880 SCQ4-SLSS6 @ 0.0°
18	22.494	4.250	LOCK 880 SCQ4-SLSS6 @ 0.0°

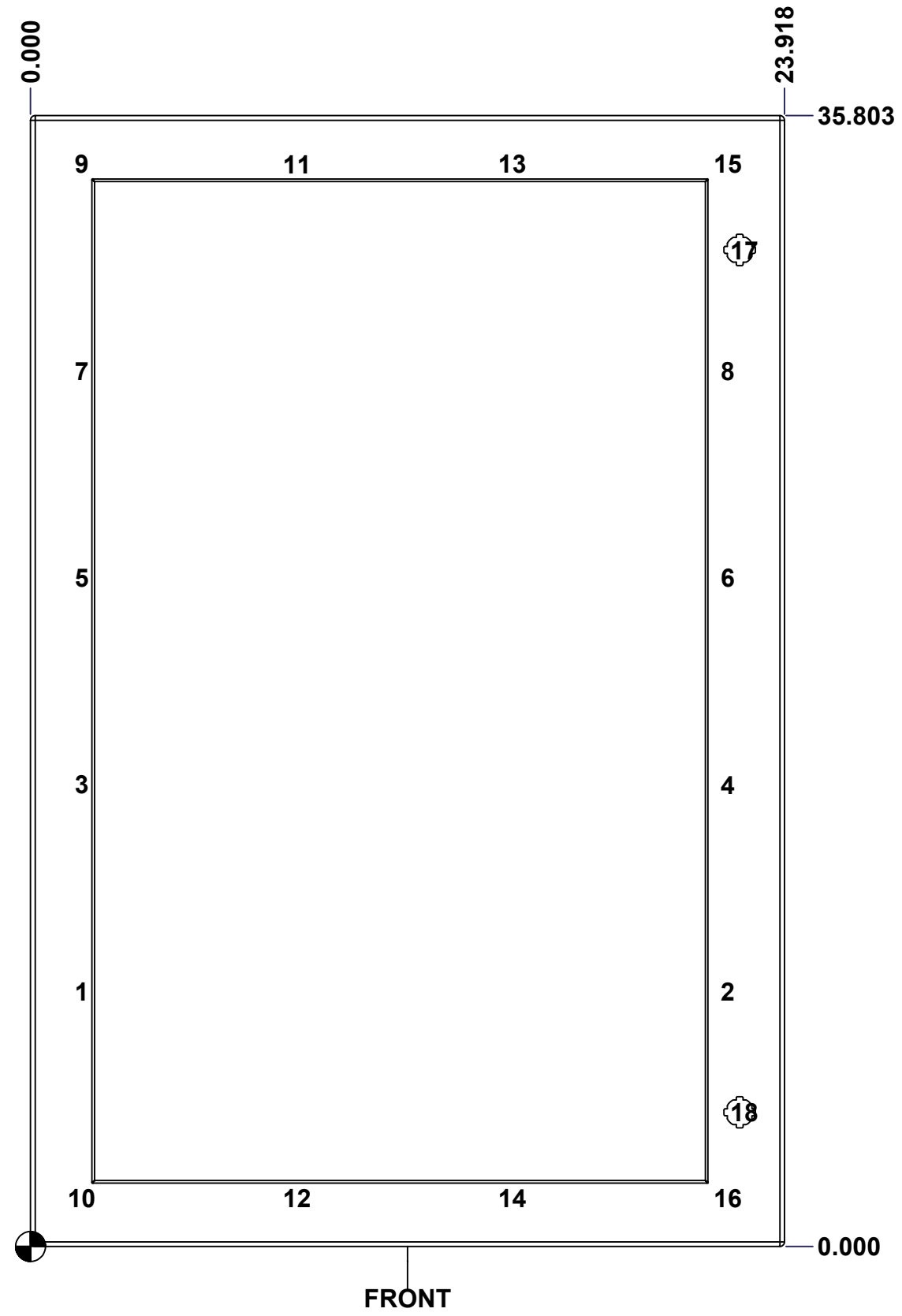

	Description	Status
	5412ESSW 36" x 24" Cover	(NULL)
	Part Number Numéro Pièce	Rev.
	5412ESSW362408C	0
		2
		3

This drawing is confidential and must not be reproduced or used without the consent of EXM

Ce dessin est confidentiel et ne doit pas être reproduit ou utilisé sans le consentement de EXM

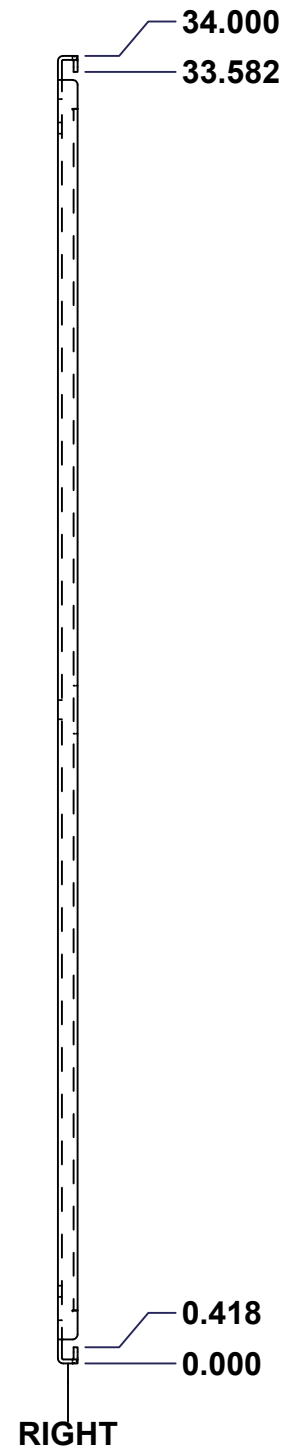
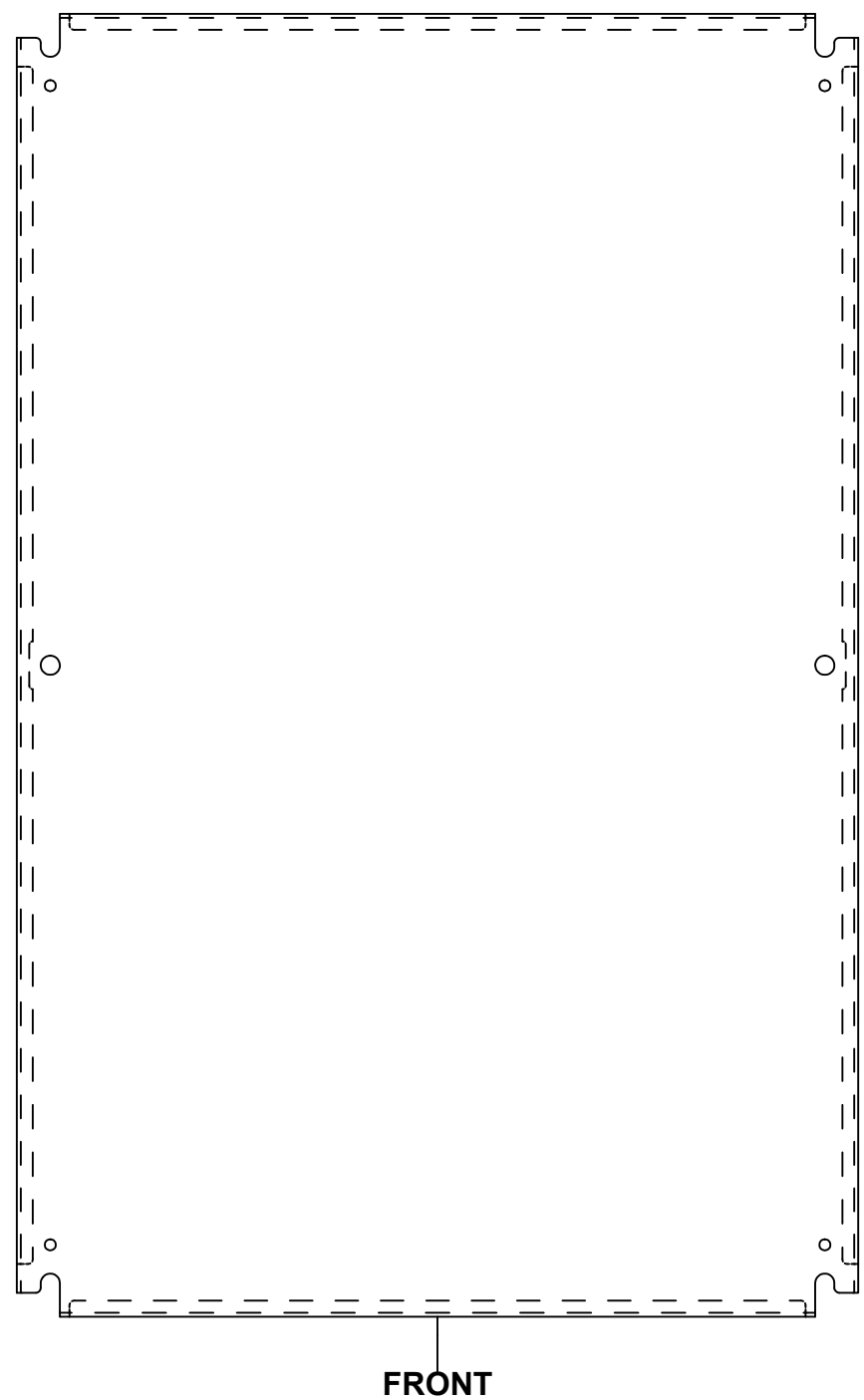
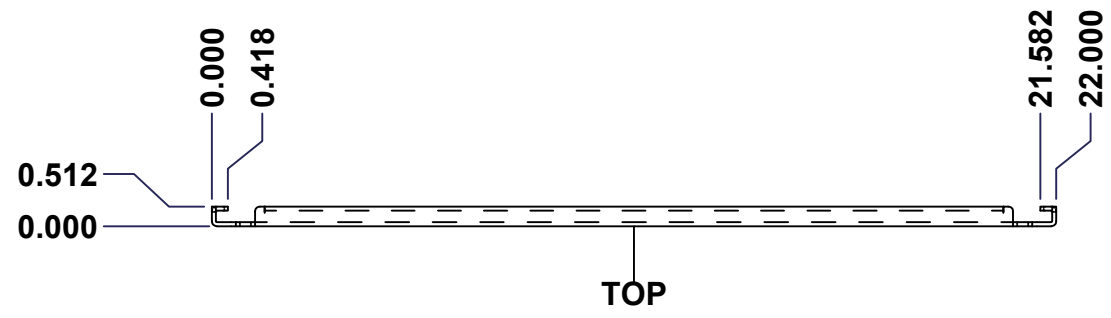

No.	Revisions	Date	By/Par

Isometric View

Tél: (450) 979-4373 Fax: (450) 979-4626 www.exmweb.com		Flatness Aplatissement Max 3.0mm Projection
Customer Client	Date	
Drawn By / Dessiné Par: BoxCad	Date: 1/23/2007	
Material / Matière	See Part List	
Color / Couleur	See Part List	Finish / Fini: See Part List
Description: 881 SP - Inner Panel		Detail Rev.
Part Number / Numéro Pièce: 881 SP3624G	Rev. 0	1/2

Qty	Part Number	Rev	Description	Material	Color	Finish
1	881 SP3624G-P	0	881 SP - Inner Panel Part	12 Ga Galvanized	Unpainted	Galvanized

Parts List

This drawing is confidential and must not be reproduced or used without the consent of EXM

Ce dessin est confidentiel et ne doit pas être reproduit ou utilisé sans le consentement de EXM

Table 1			FRONT VIEW
CUT-OUT	XDIM	YDIM	DESCRIPTION
1	0.875	1.875	GROUND HOLE (RND Ø0.290)
2	21.125	1.875	GROUND HOLE (RND Ø0.290)
3	0.875	32.125	GROUND HOLE (RND Ø0.290)
4	21.125	32.125	GROUND HOLE (RND Ø0.290)
5	0.875	17.000	MTG STUD HOLE (RND Ø0.500)
6	21.125	17.000	MTG STUD HOLE (RND Ø0.500)

All knockouts are actual size / Les disques défonçables sont grandeur réel

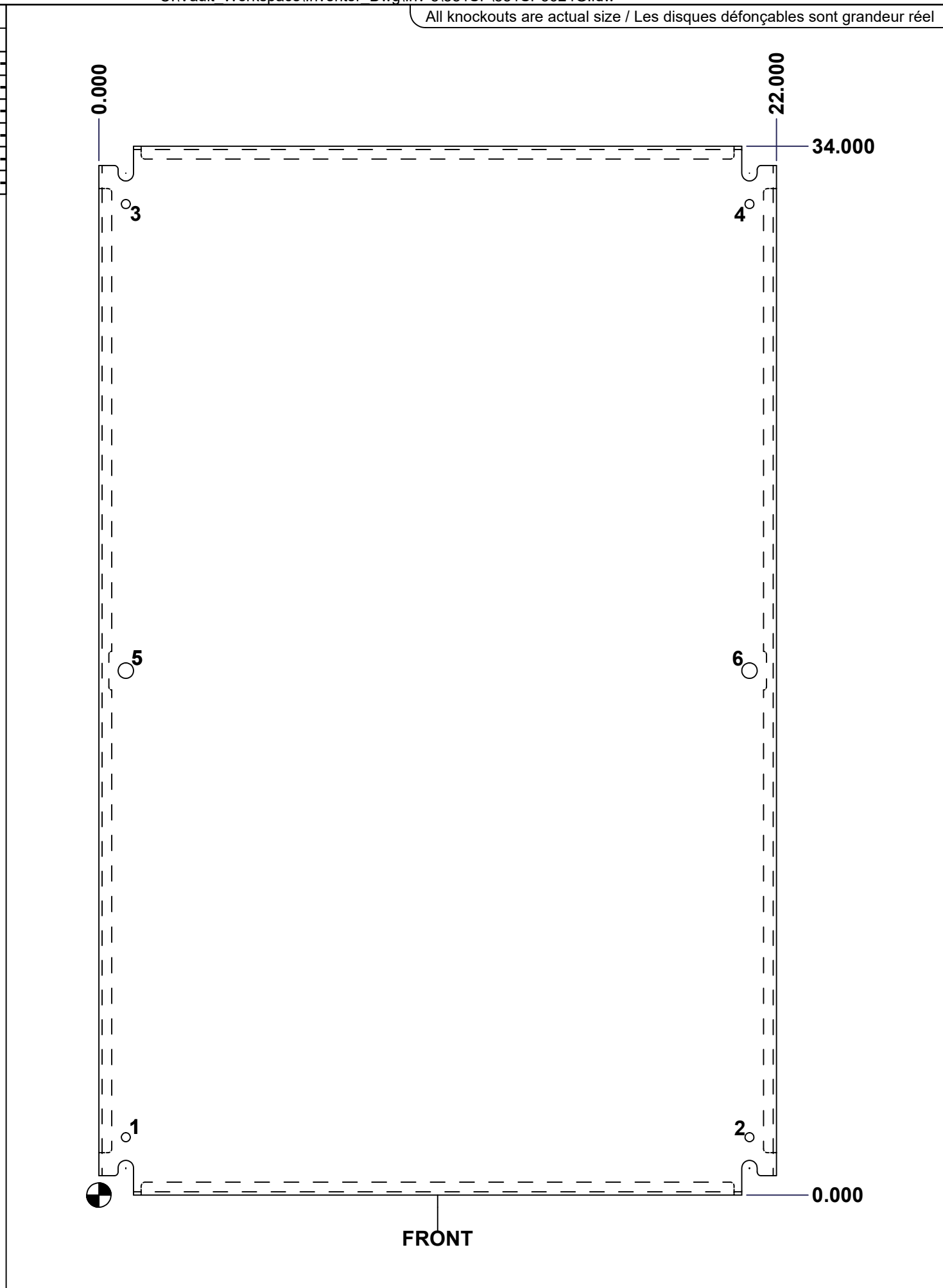

No.	Revisions	Date	By/Par

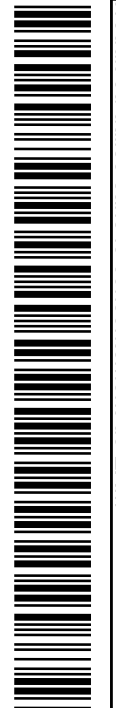
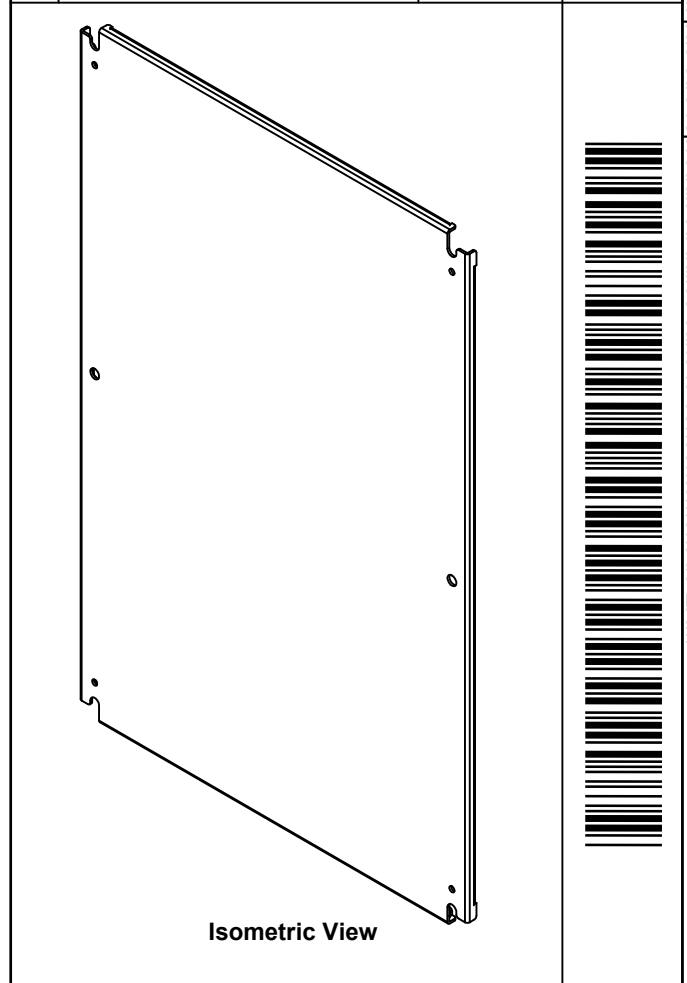

		Tél: (450) 979-4373 Fax: (450) 979-4626 www.exmweb.com		Flatness Aplatissement Max 3.0mm	
Customer Client		Date		Projection 	
Drawn By Dessiné Par BoxCad		Date 1/23/2007		Material Matière See Part List	
Color Couleur See Part List		Finish Fini See Part List		Description 881 SP - Inner Panel	
Part Number Numéro Pièce 881 SP3624G		Detail Rev. Rev. 0		2 2	