

This drawing is confidential and must not be reproduced or used without the consent of EXM

Ce dessin est confidentiel et ne doit pas être reproduit ou utilisé sans le consentement de EXM

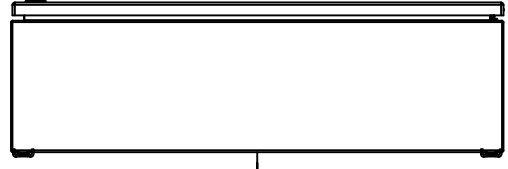

TOP

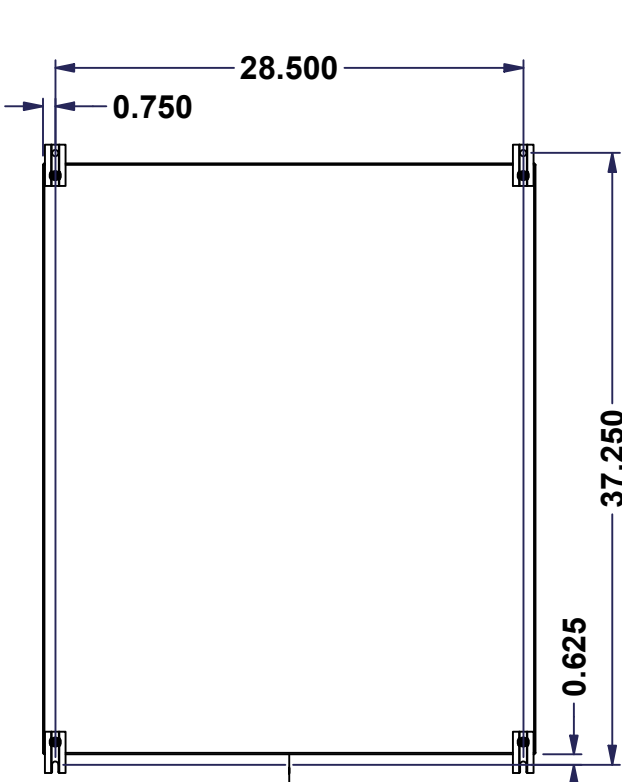

BACK

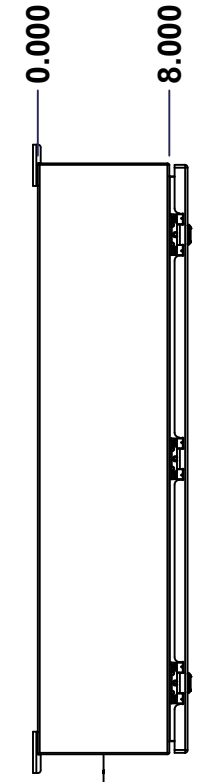

LEFT

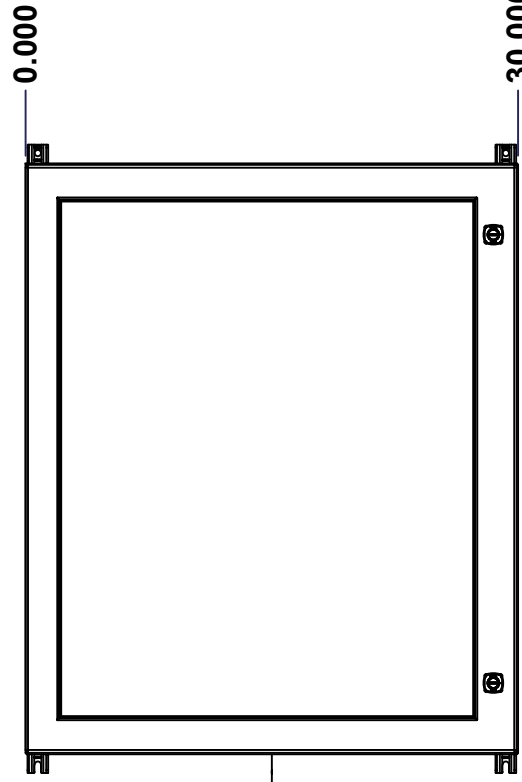

FRONT

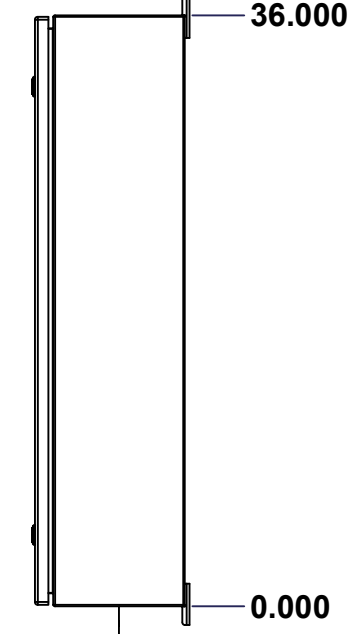

RIGHT

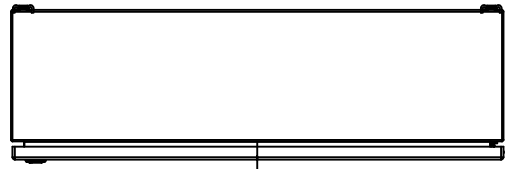

BOTTOM

No.	Revisions	Date	By/Par

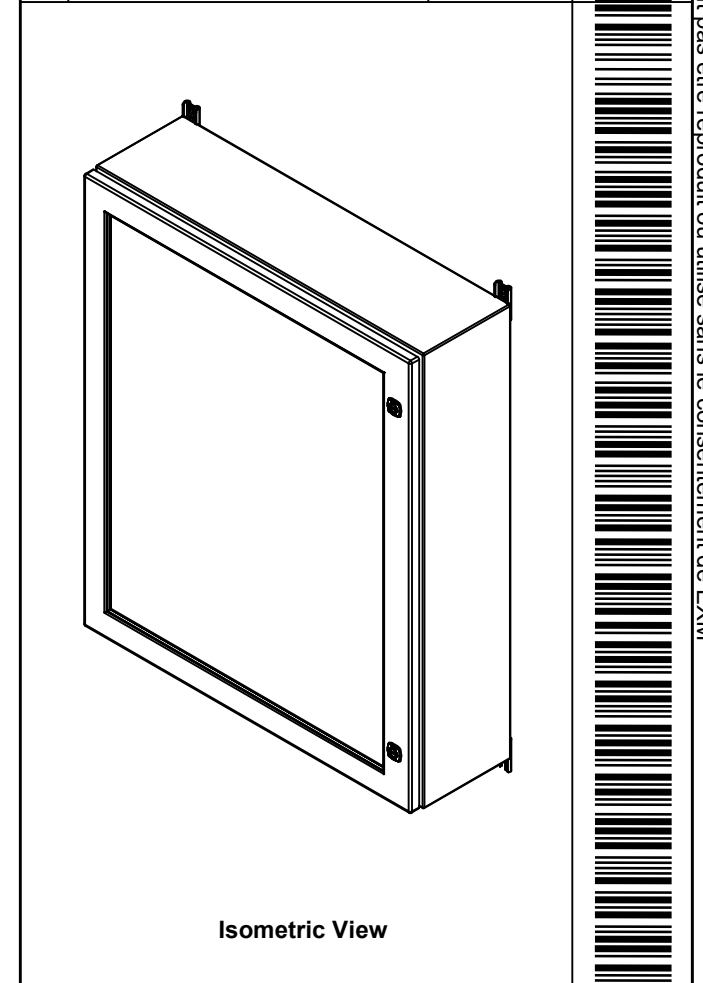

Isometric View

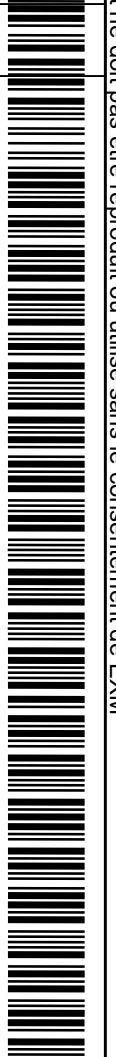

**GRAIN DIRECTION:  
TOP/BOTTOM: HORIZONTAL  
LEFT/RIGHT/BACK/FRONT: VERTICAL**

	Flatness Aplatissement Max 3.0mm
	Projection 
Customer Client	Date
Drawn By Dessiné Par: BoxCad: BoxCad	Date: 09-Jun-23
Material Matière: 14 Ga Stainless Steel 316 (1.7mm)	Color Couleur: Unpainted
Description 5412ESSW 36" x 30" x 8" Assembly	Finish Fini: Brushed
Part Number Numéro Pièce: 5412ESSW3630086THNOIP	Detail Rev. Rev. 1

SEE BILL OF MATERIAL ON LAST PAGE 5412ESSW3630086THNOIP 0 15

This drawing is confidential and must not be reproduced or used without the consent of EXM

Ce dessin est confidentiel et ne doit pas être reproduit ou utilisé sans le consentement de EXM

NOTE	
ITEM	DESCRIPTION
1	NEMA 4X Enclosure
2	C/W Standard ground studs on box and cover
3	W/O Standard door stiffener
4	W/O Inner panel
5	C/W Standard inner panel mounting studs
6	C/W 885 ESMF4_OPEN Sold separately (Installed)
7	C/W 885 ESMF4_CLOSE Sold separately (Installed)
8	C/W R5 Insulation (Installed by EXM)

No.	Revisions	Date	By/Par

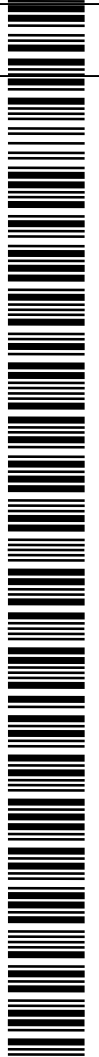
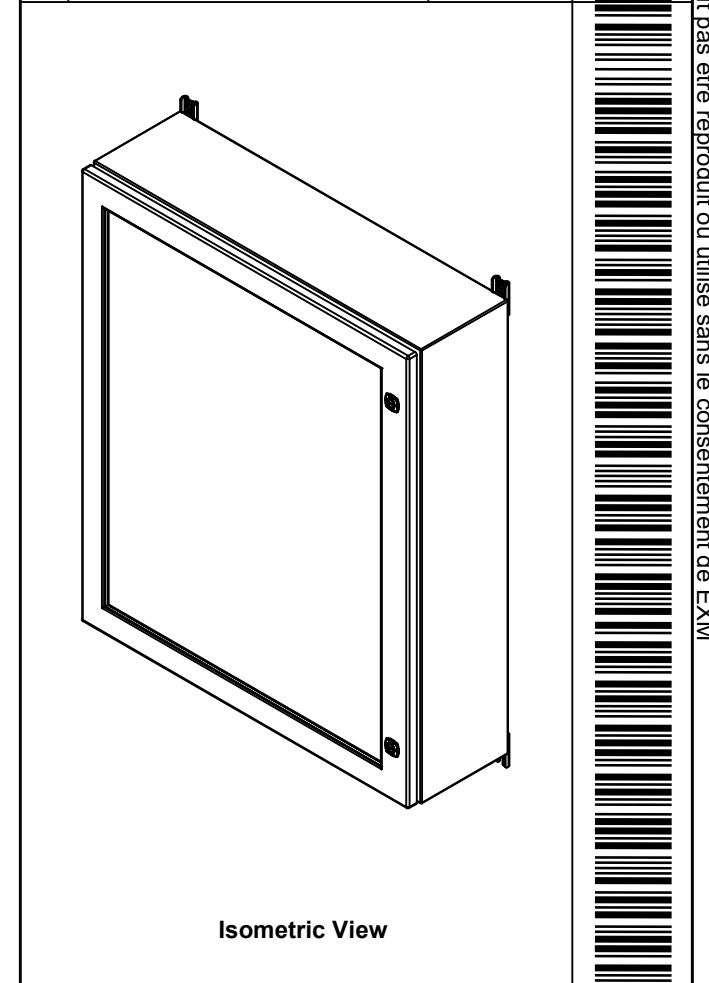

 Tél: (450) 979-4373  
 Fax: (450) 979-4626  
[www.exmweb.com](http://www.exmweb.com)

Flatness / Aplatissement: Max 3.0mm  
 Projection: 

Customer Client	Date
Drawn By / Dessiné Par: BoxCad: BoxCad	Date: 09-Jun-23

Material / Matière: 14 Ga Stainless Steel 316 (1.7mm)

Color / Couleur: Unpainted	Finish / Fini: Brushed
----------------------------	------------------------

Description: 5412ESSW 36" x 30" x 8" Assembly

Part Number / Numéro Pièce: <b>5412ESSW3630086THNOIP</b>	Rev. / Révisé: <b>0</b>	2	15
--	-------------------------	---	----

Qty	Part Number	Rev	Description
6	STK-Q-00600	2	M12 to M8 Adaptor
1	STK-K-01800	5	5412 ES Accessory Kit
1	5412ESSW3630086THNO IPC	0	5412ESSW 36" x 30" Cover
1	5412ESSW3630086THNO IPB	0	5412ESSW 36" x 30" x 8" Body
3	STK-Q-04051-08	1	M6 x 8mm Stainless Steel Hexagon Socket Head Machine Screw with Nyseal
Parts List			

PACKING		
ITEM	QTY	DESCRIPTION
Cardboard sleeve	2	Top and Bottom
Cardboard strip	2	Between back of enclosure and inner panel
Plastic bag	1	To protect cover surface and inside gasket
Plastic strap - Black	2	To Squeeze the 2 cardboard sleeve together
Packaging label	1	White label with product number

This drawing is confidential and must not be reproduced or used without the consent of EXM

Ce dessin est confidentiel et ne doit pas être reproduit ou utilisé sans le consentement de EXM

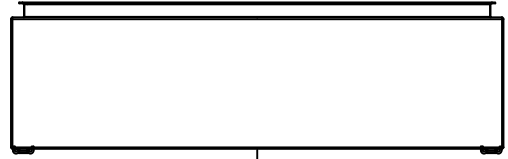

TOP

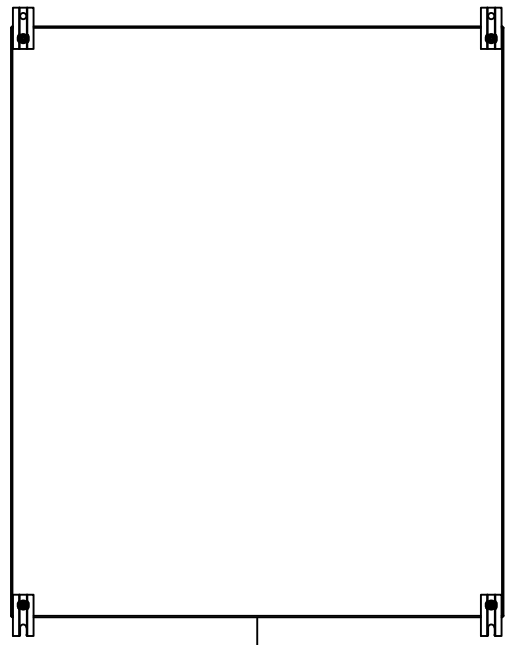

BACK

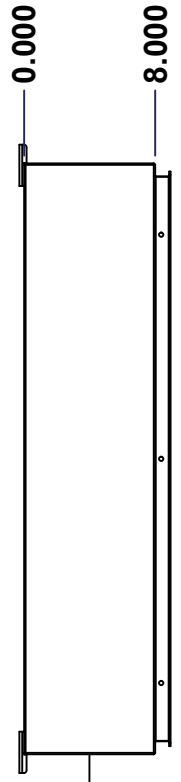

LEFT

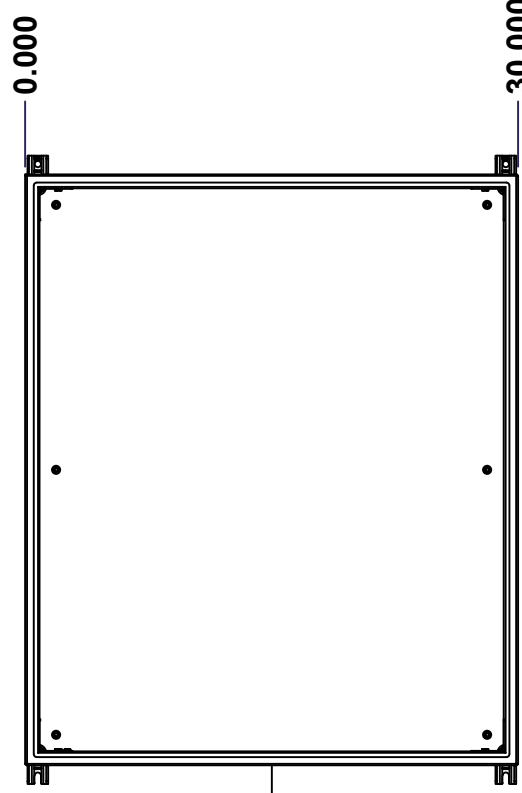

FRONT

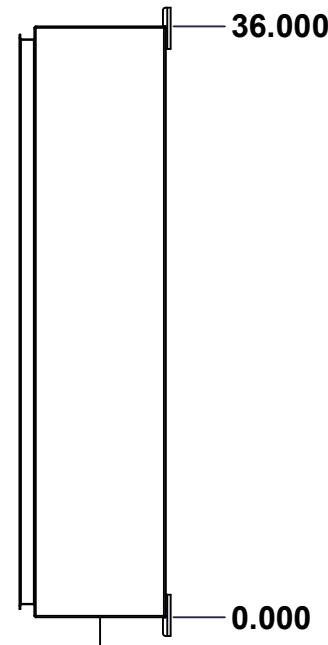

RIGHT

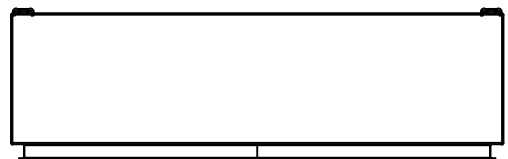

BOTTOM

No.	Revisions	Date	By/Par

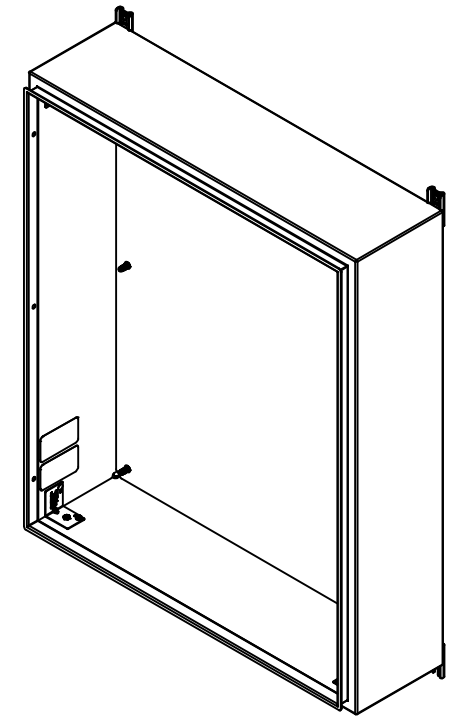

Isometric View



Tél: (450) 979-4373  
 Fax: (450) 979-4626  
[www.exmweb.com](http://www.exmweb.com)

Flatness  
Aplatissement  
Max 5.0mm  
Projection

Customer Client	Date
Drawn By Dessiné Par BoxCad: BoxCad	Date 09-Jun-23
Material Matière 14 Ga Stainless Steel 316 (1.7mm)	
Color Couleur Unpainted	Finish Fini Brushed
Description 5412ESSW 36" x 30" x 8" Body	Detail Rev.
Part Number Numéro Pièce	Rev. 3

This drawing is confidential and must not be reproduced or used without the consent of EXM

Ce dessin est confidentiel et ne doit pas être reproduit ou utilisé sans le consentement de EXM

STANDARD FEATURES ARE NOT LISTED IN THIS HOLE TABLE			
HOLE TABLE - TOP VIEW (CUSTOM FEATURE ONLY)			
CUT-OUT	XDIM	YDIM	DESCRIPTION
1	2.000	6.500	INSUL. STUD M6 x 18mm (Inside)
2	28.000	6.500	INSUL. STUD M6 x 18mm (Inside)

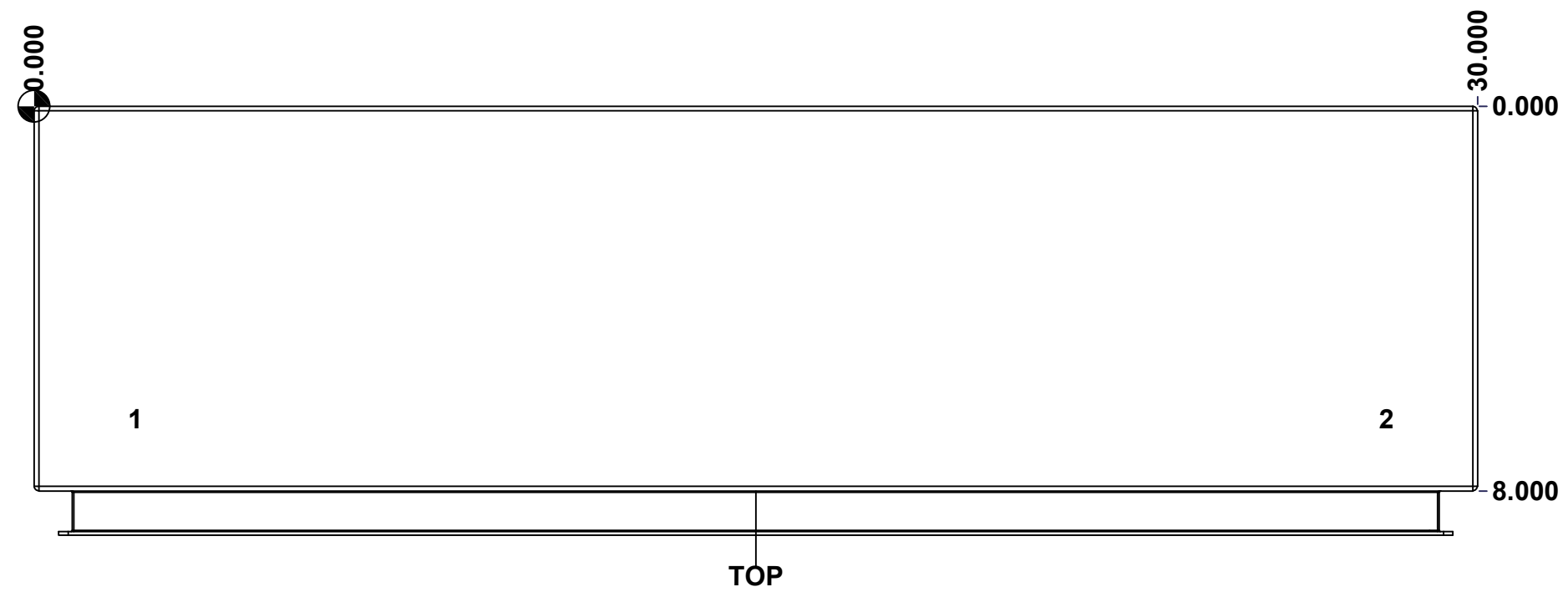

	Description	Status
	5412ESSW 36" x 30" x 8" Body	(NULL)
	Part Number Numéro Pièce	Rev.
	<b>5412ESSW3630086THNOIPB 0</b>	4
		15

This drawing is confidential and must not be reproduced or used without the consent of EXM

Ce dessin est confidentiel et ne doit pas être reproduit ou utilisé sans le consentement de EXM

<b>STANDARD FEATURES ARE NOT LISTED IN THIS HOLE TABLE</b>			
<b>HOLE TABLE - BOTTOM VIEW (CUSTOM FEATURE ONLY)</b>			
CUT-OUT	XDIM	YDIM	DESCRIPTION
1	2.000	6.500	INSUL. STUD M6 x 18mm (Inside)
2	28.000	6.500	INSUL. STUD M6 x 18mm (Inside)

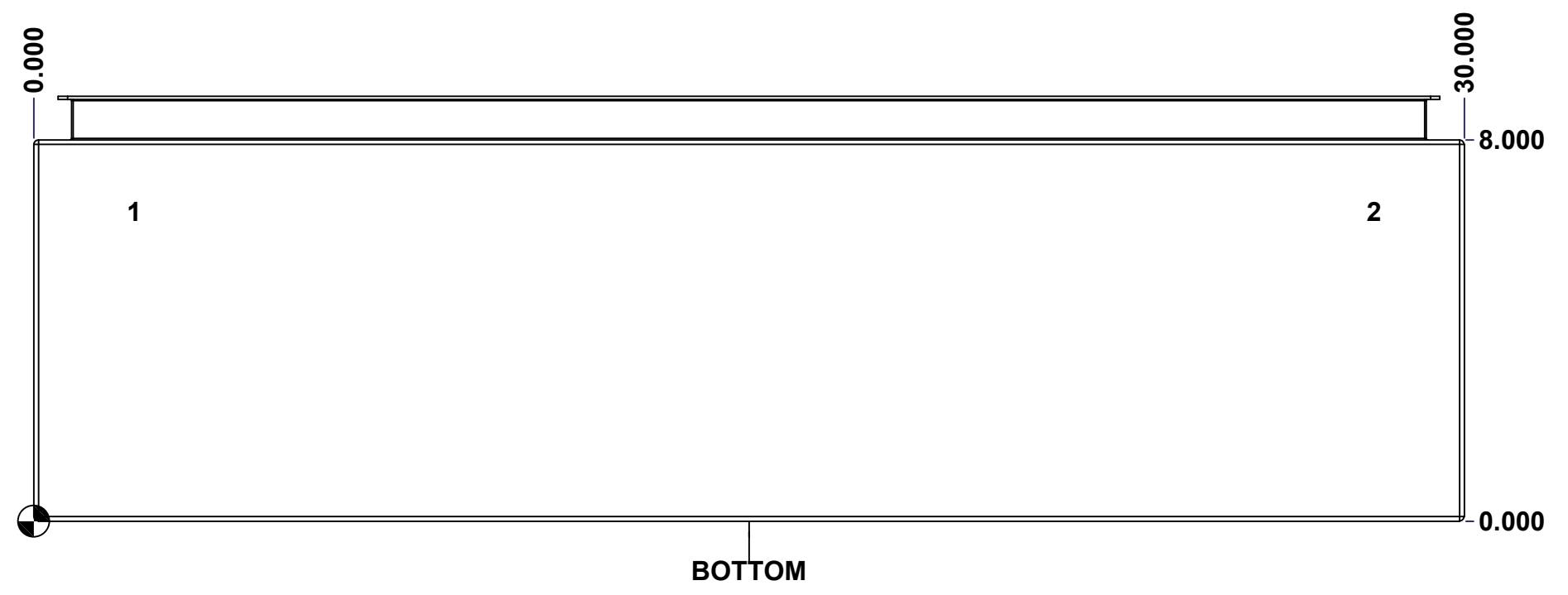

	Description	Status
	5412ESSW 36" x 30" x 8" Body	(NULL)
	Part Number Numéro Pièce	Rev. 5
	<b>5412ESSW3630086THNOIPB 0</b>	15

This drawing is confidential and must not be reproduced or used without the consent of EXM

Ce dessin est confidentiel et ne doit pas être reproduit ou utilisé sans le consentement de EXM

**STANDARD FEATURES ARE NOT LISTED IN THIS HOLE TABLE**

**HOLE TABLE - BACK VIEW (CUSTOM FEATURE ONLY)**

CUT-OUT	XDIM	YDIM	DESCRIPTION
1	1.875	1.875	IP STUD M8 x 35mm (Inside)
2	1.875	34.125	IP STUD M8 x 35mm (Inside)
3	28.125	34.125	IP STUD M8 x 35mm (Inside)
4	28.125	1.875	IP STUD M8 x 35mm (Inside)
5	1.875	18.000	IP STUD M8 x 35mm (Inside)
6	28.125	18.000	IP STUD M8 x 35mm (Inside)
-----			
7	29.250	0.000	FOOT 885 ESMF4_OPEN
8	0.750	0.000	FOOT 885 ESMF4_OPEN
9	29.250	36.000	FOOT 885 ESMF4_CLOSE
10	0.750	36.000	FOOT 885 ESMF4_CLOSE

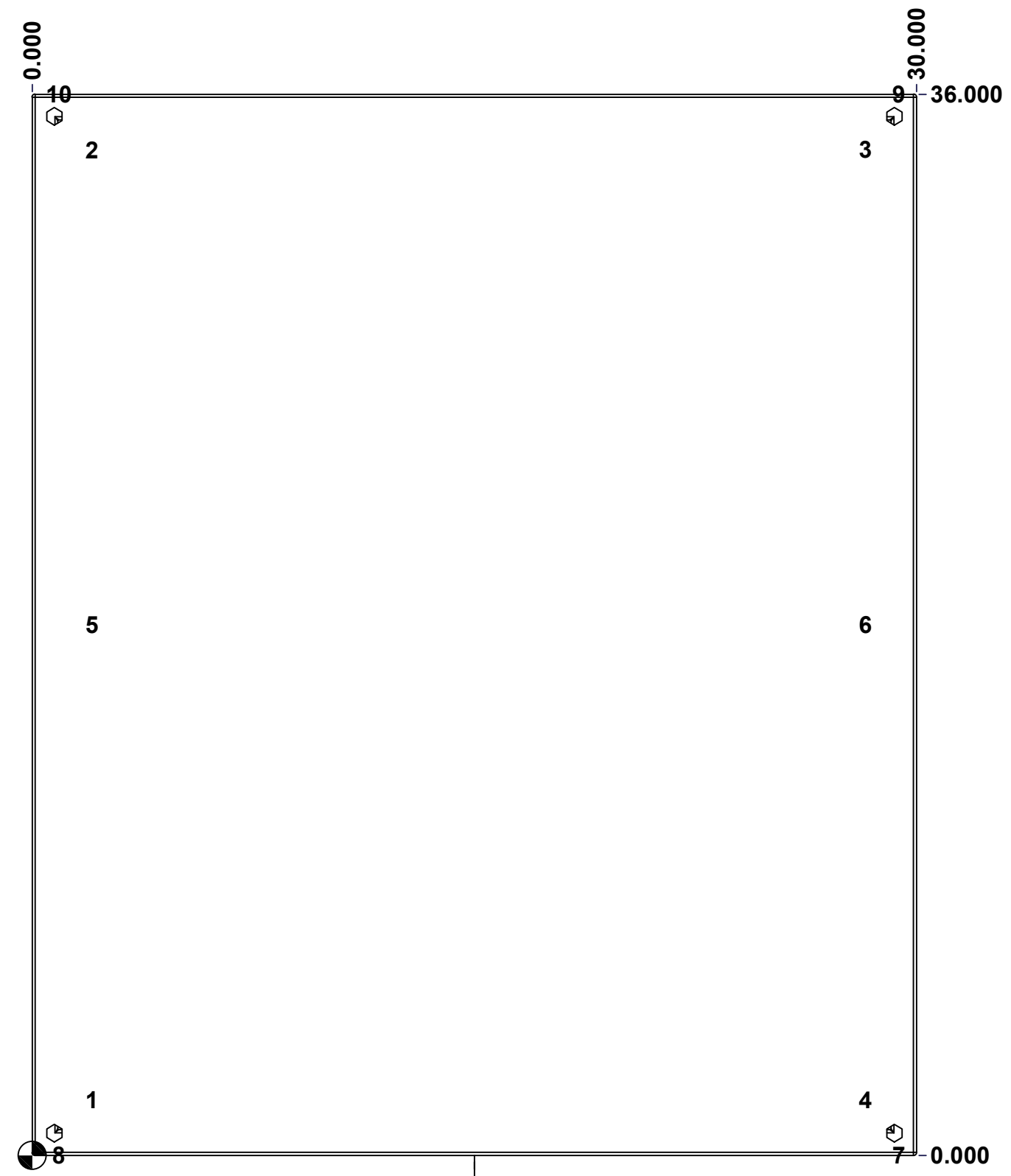

BACK

	Description	Status
	5412ESSW 36" x 30" x 8" Body	(NULL)
	Part Number Numéro Pièce	Rev.
	<b>5412ESSW3630086THNOIPB 0</b>	6
		15

This drawing is confidential and must not be reproduced or used without the consent of EXM

Ce dessin est confidentiel et ne doit pas être reproduit ou utilisé sans le consentement de EXM

No.	Revisions	Date	By/Par

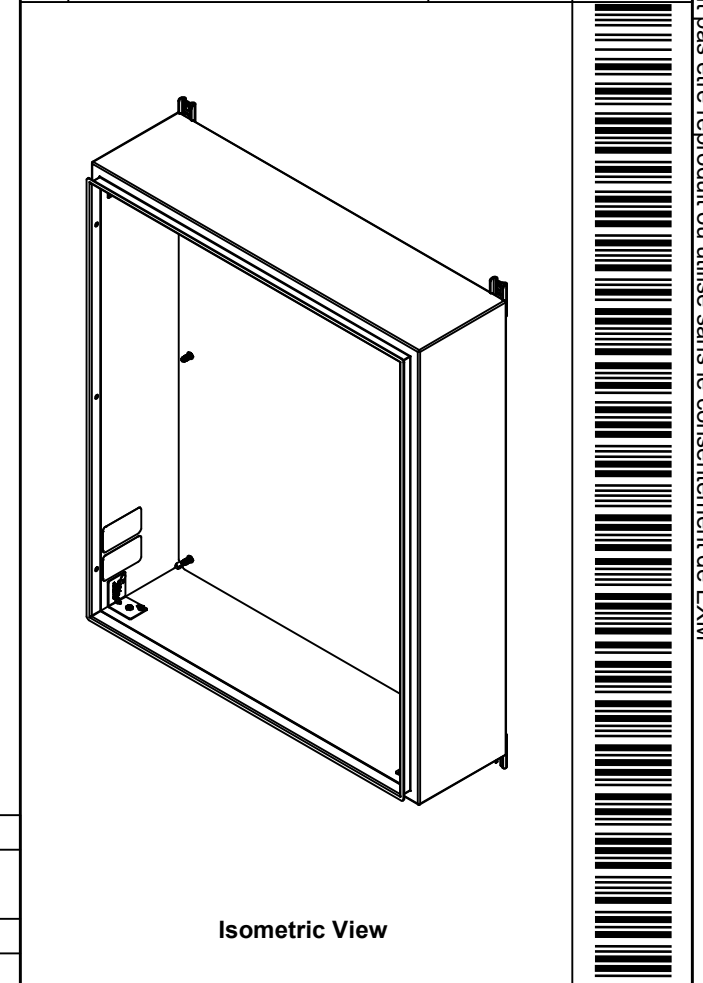

2	885ESMF4-FEET	0	885 ESMF4 Stainless Steel Mounting Foot
4	RIVET_NUT_SS_M10_FH_CE	0	Stainless Steel Rivet Nut M10 (Low Profile Close End)
4	STK-Q-06670	2	M10 x 16mm Stainless Steel Machine Screw
2	885ESMF4-FEET-A	0	885 ESMF4 Stainless Steel Mounting Foot (Opened Slot)
2	STK-S-00100	0	3.5" x 2" Silver Milar Flexcon Sticker
1	STK-K-70554	3	5412 ESTH Accessory Kit
1	5412ESSW3630086THNO IPI-RS	0	5412ESSW 36" x 30" Right Insulation
1	5412ESSW3630086THNO IPI-LS	0	5412ESSW 36" x 30" Left Insulation
1	5412ESSW3630086THNO IPI-BT	0	5412ESSW 36" x 30" Top and Bottom Insulation
1	5412ESSW3630086THNO IPI-TP	0	5412ESSW 36" x 30" Top and Bottom Insulation
1	5412ESSW3630086THNO IPI-B	0	5412ESSW 36" x 30" Back Insulation
4	STK-Q-16070	1	Stud M6 x 18mm Stainless steel
6	STK-Q-16020	1	Stud M8 x 35mm Stainless Steel
1	5412ESSW3630086THNO IPB-P	0	5412ESSW 36" x 30" x 8" Body Part

Qty	Part Number	Rev	Description
Parts List			



Tél: (450) 979-4373  
Fax: (450) 979-4626  
[www.exmweb.com](http://www.exmweb.com)

Flatness  
Aplatissement  
Max 0.0mm  
Projection

Customer Client	Date
Drawn By Dessiné Par: BoxCad: BoxCad	Date: 09-Jun-23
Material Matière: 14 Ga Stainless Steel 316 (1.7mm)	
Color Couleur: Unpainted	Finish Fini: Brushed
Description: 5412ESSW 36" x 30" x 8" Body	Detail Rev.
Part Number Numéro Pièce: 5412ESSW3630086THNOIPB 0	Rev. 7

This drawing is confidential and must not be reproduced or used without the consent of EXM

Ce dessin est confidentiel et ne doit pas être reproduit ou utilisé sans le consentement de EXM

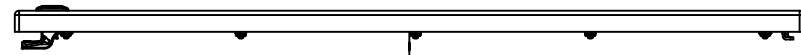

TOP

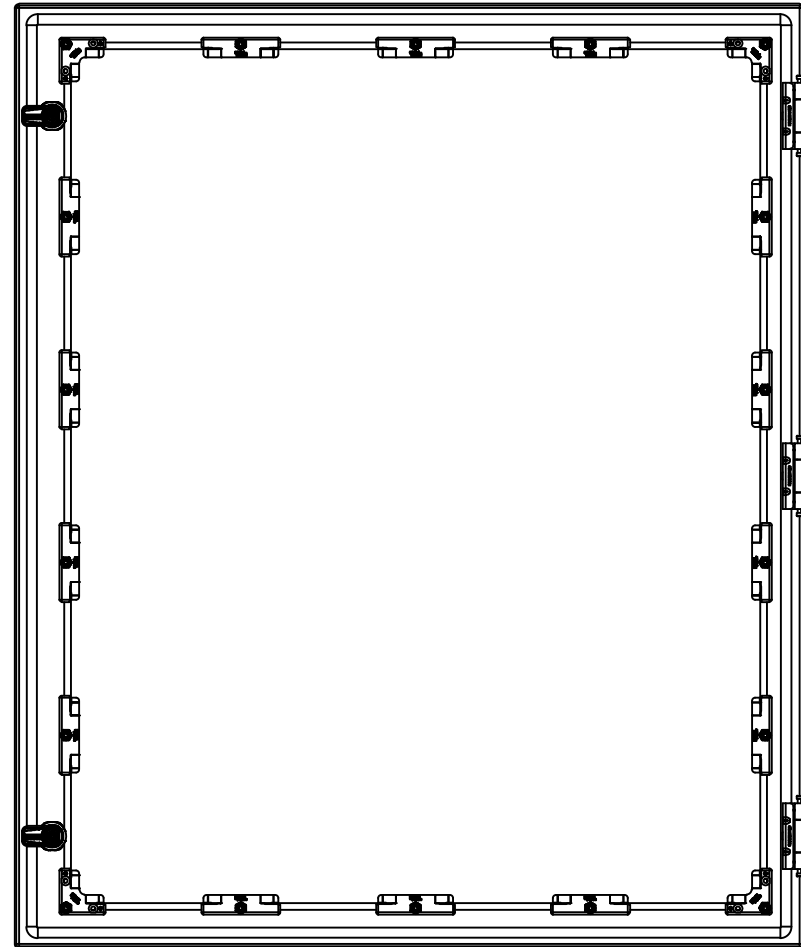

BACK

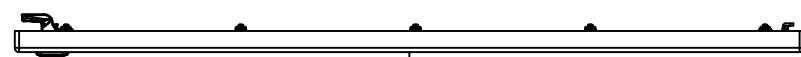

BOTTOM

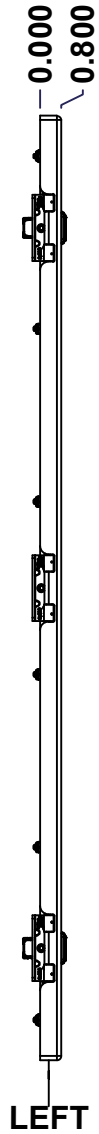

LEFT

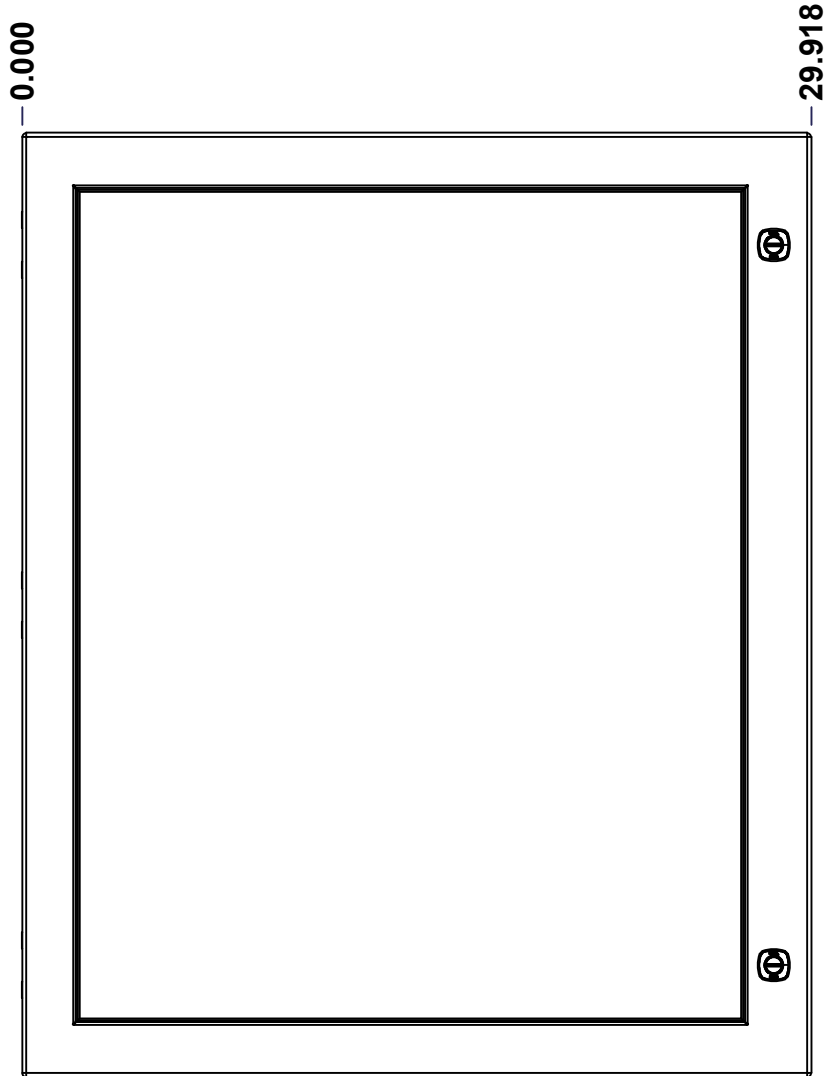

FRONT

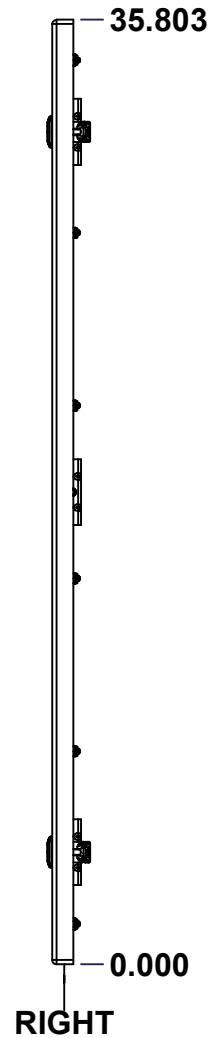

RIGHT

No.	Revisions	Date	By/Par

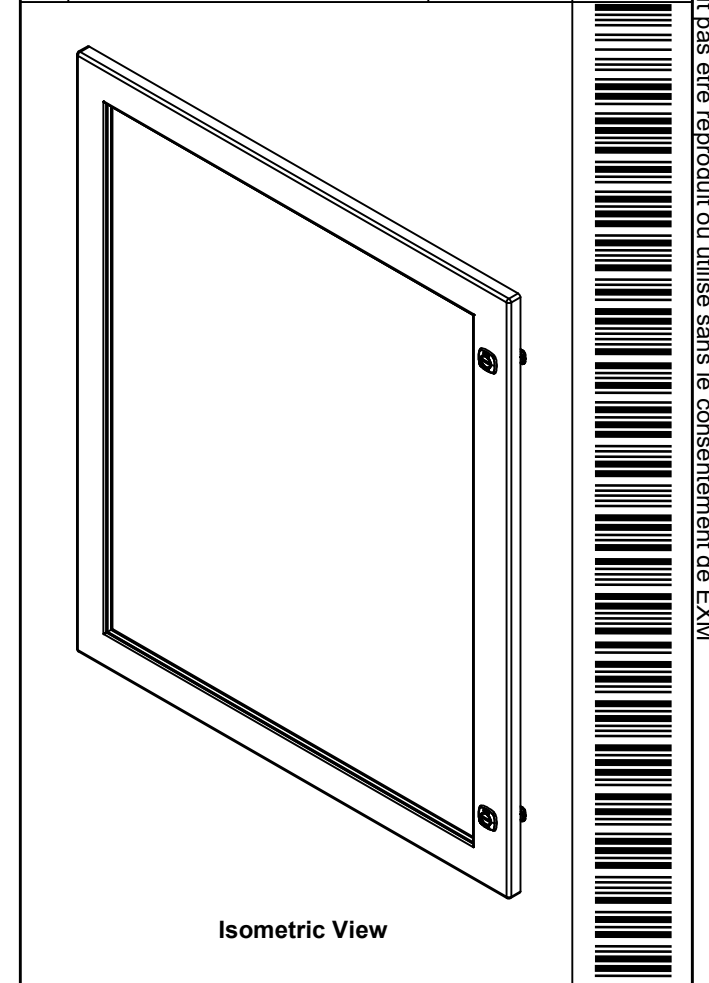

Isometric View



		Flatness / Aplatissement Max 5.0mm Projection	
Customer Client		Date	
Drawn By / Dessiné Par: BoxCad: BoxCad		Date: 09-Jun-23	
Material / Matière: 14 Ga Stainless Steel 316 (1.7mm)			
Color / Couleur: Unpainted		Finish / Fini: Brushed	
Description: 5412ESSW 36" x 30" Cover			Detail Rev.
Part Number / Numéro Pièce: 5412ESSW3630086THNOIP			Rev. 8

SEE BILL OF MATERIAL ON LAST PAGE 5412ESSW3630086THNOIPC 0



This drawing is confidential and must not be reproduced or used without the consent of EXM

Ce dessin est confidentiel et ne doit pas être reproduit ou utilisé sans le consentement de EXM

**STANDARD FEATURES ARE NOT LISTED IN THIS HOLE TABLE**

**HOLE TABLE - FRONT VIEW (CUSTOM FEATURE ONLY)**

CUT-OUT	XDIM	YDIM	DESCRIPTION
1	1.469	8.077	STUD M6 x 18mm (Inside)
2	27.968	8.077	STUD M6 x 18mm (Inside)
3	1.469	14.627	STUD M6 x 18mm (Inside)
4	27.968	14.627	STUD M6 x 18mm (Inside)
5	1.469	21.176	STUD M6 x 18mm (Inside)
6	27.968	21.176	STUD M6 x 18mm (Inside)
7	1.469	27.726	STUD M6 x 18mm (Inside)
8	27.968	27.726	STUD M6 x 18mm (Inside)
9	1.469	34.276	STUD M6 x 18mm (Inside)
10	1.469	1.527	STUD M6 x 18mm (Inside)
11	8.094	34.276	STUD M6 x 18mm (Inside)
12	8.094	1.527	STUD M6 x 18mm (Inside)
13	14.719	34.276	STUD M6 x 18mm (Inside)
14	14.719	1.527	STUD M6 x 18mm (Inside)
15	21.343	34.276	STUD M6 x 18mm (Inside)
16	21.343	1.527	STUD M6 x 18mm (Inside)
17	27.968	34.276	STUD M6 x 18mm (Inside)
18	27.968	1.527	STUD M6 x 18mm (Inside)
-----			
19	28.494	31.553	880 SCQ4-SLSS6
20	28.494	4.250	880 SCQ4-SLSS6

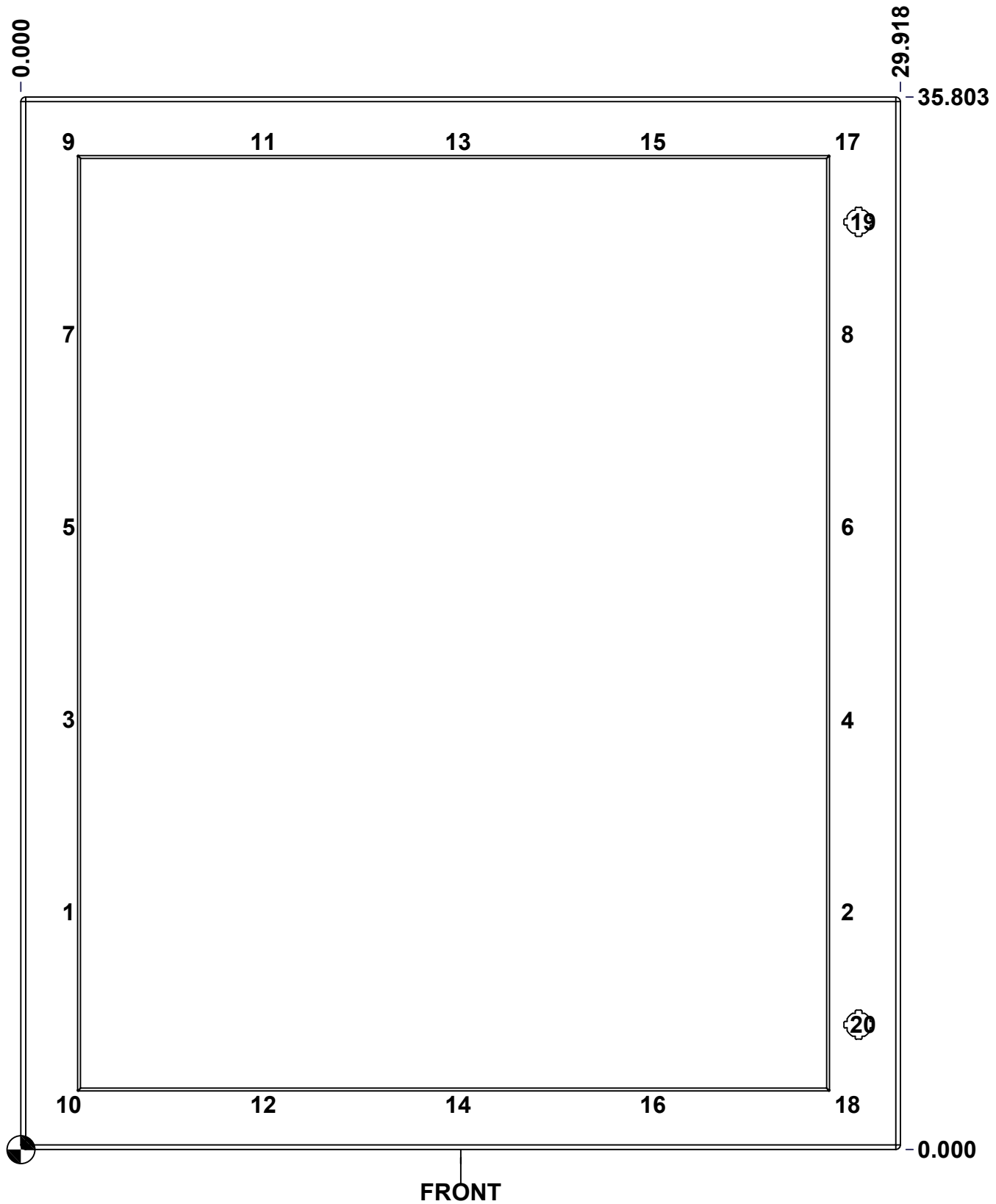

	Description	Status
	5412ESSW 36" x 30" Cover	(NULL)
	Part Number	Rev.
	Numéro Pièce	9
	<b>5412ESSW3630086THNOIPC 0</b>	15



This drawing is confidential and must not be reproduced or used without the consent of EXM

Ce dessin est confidentiel et ne doit pas être reproduit ou utilisé sans le consentement de EXM

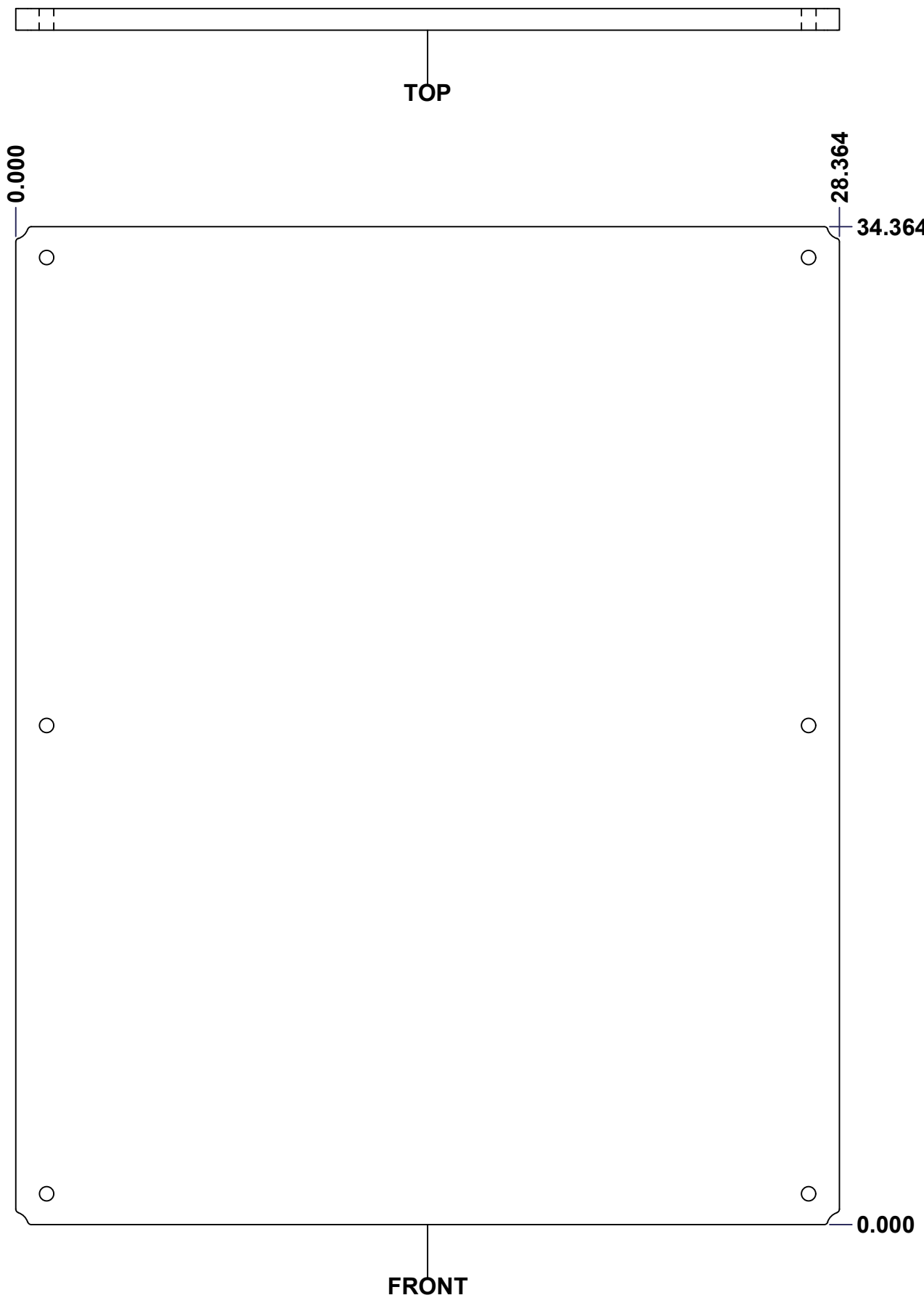

No.	Revisions	Date	By/Par

**Isometric View**

<p>Tél: (450) 979-4373                  Fax: (450) 979-4626  <a href="http://www.exmweb.com">www.exmweb.com</a></p>		Flatness Aplatissement
		Max 3.0mm
Projection		
Customer Client	Date	
Drawn By Dessiné Par	BoxCad: Patrick Deschenes	Date 23-Jan-07
Material Matière	Polyisocyanurate	
Color Couleur	Aluminum	Finish Fini N/A
Description	Detail Rev.	
5412ESSW 36" x 30" Back Insulation		
Part Number Numéro Pièce	Rev.	11
SEE BILL OF MATERIAL ON LAST PAGE 5412ESSW3630086THNOIPI-B 0		15

This drawing is confidential and must not be reproduced or used without the consent of EXM

Ce dessin est confidentiel et ne doit pas être reproduit ou utilisé sans le consentement de EXM

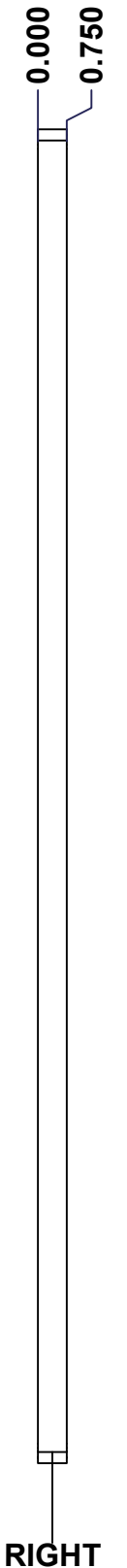
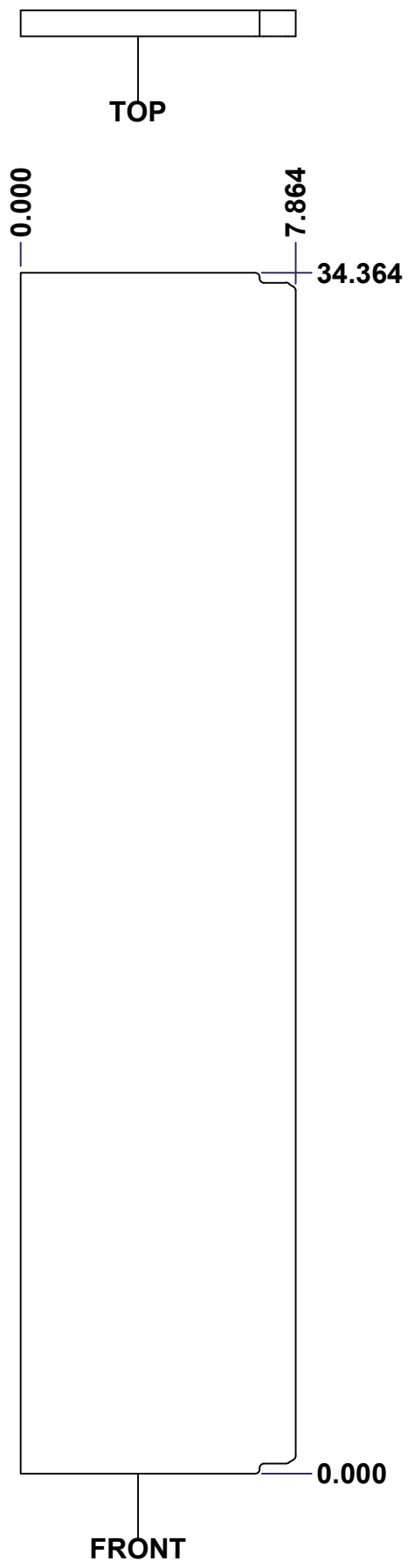

No.	Revisions	Date	By/Par

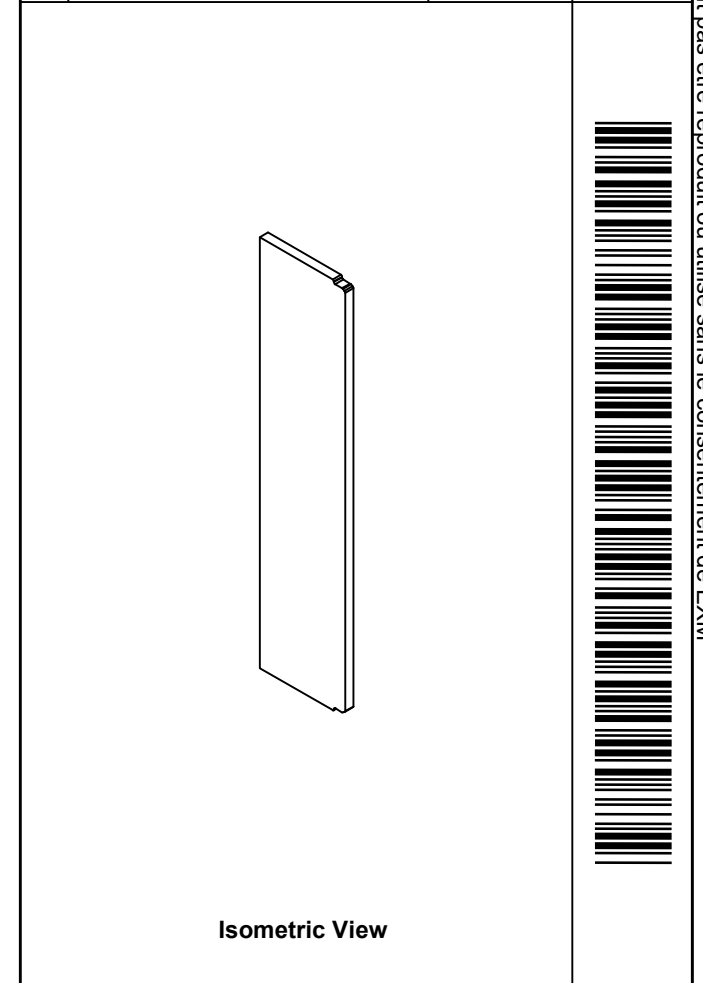

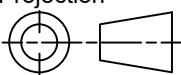
 Tél: (450) 979-4373 Fax: (450) 979-4626 <a href="http://www.exmweb.com">www.exmweb.com</a>		Flatness Aplatissement Max 3.0mm
Projection 		Date 23-Jan-07
Customer Client	Date	
Drawn By Dessiné Par	BoxCad: Patrick Deschenes	Date 23-Jan-07
Material Matière	Polyisocyanurate	
Color Couleur	Aluminum	Finish Fini N/A
Description	Detail Rev.	
5412ESSW 36" x 30" Left Insulation		
Part Number Numéro Pièce	Rev.	12
5412ESSW3630086THNOIP-LS0		15

SEE BILL OF MATERIAL ON LAST PAGE

This drawing is confidential and must not be reproduced or used without the consent of EXM

Ce dessin est confidentiel et ne doit pas être reproduit ou utilisé sans le consentement de EXM

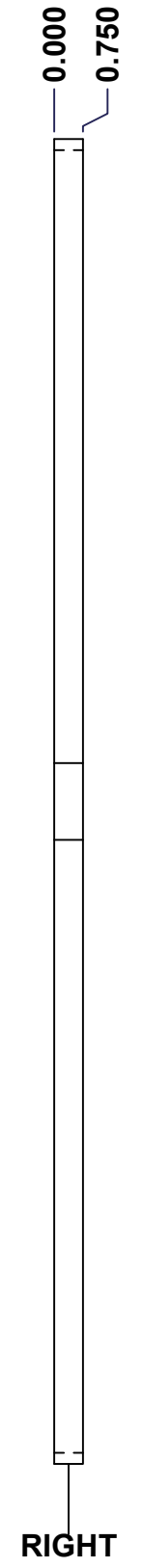
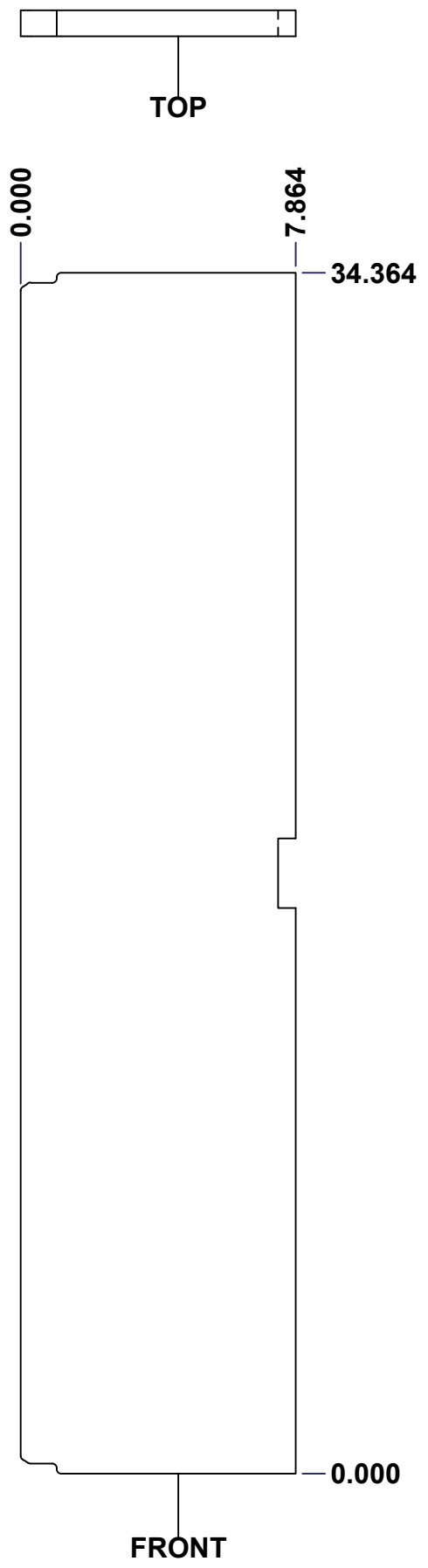

No.	Revisions	Date	By/Par

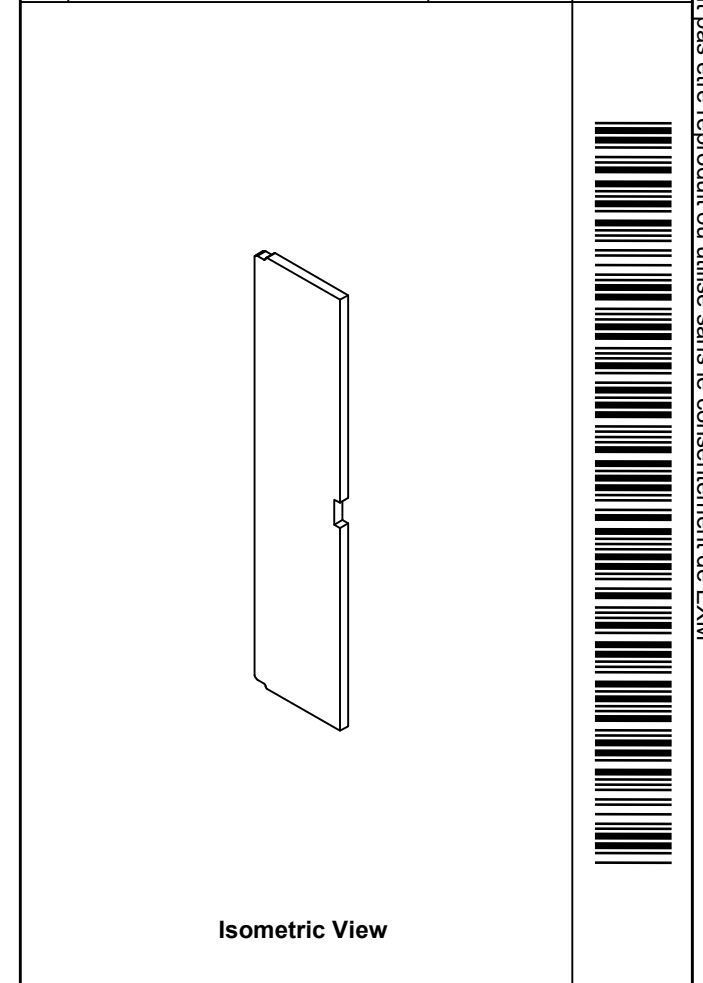

 Tél: (450) 979-4373 Fax: (450) 979-4626 <a href="http://www.exmweb.com">www.exmweb.com</a>		Flatness Aplatissement Max 3.0mm
Customer Client		Date
Drawn By Dessiné Par	BoxCad: Patrick Deschenes	Date 23-Jan-07
Material Matière Polyisocyanurate		
Color Couleur Aluminum	Finish Fini N/A	
Description 5412ESSW 36" x 30" Right Insulation		Detail Rev.
Part Number Numéro Pièce		Rev. 13

**SEE BILL OF MATERIAL ON LAST PAGE** 5412ESSW3630086THNOIPI-RS0 15

This drawing is confidential and must not be reproduced or used without the consent of EXM

Ce dessin est confidentiel et ne doit pas être reproduit ou utilisé sans le consentement de EXM

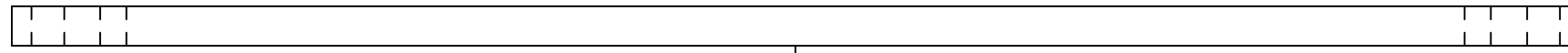

TOP

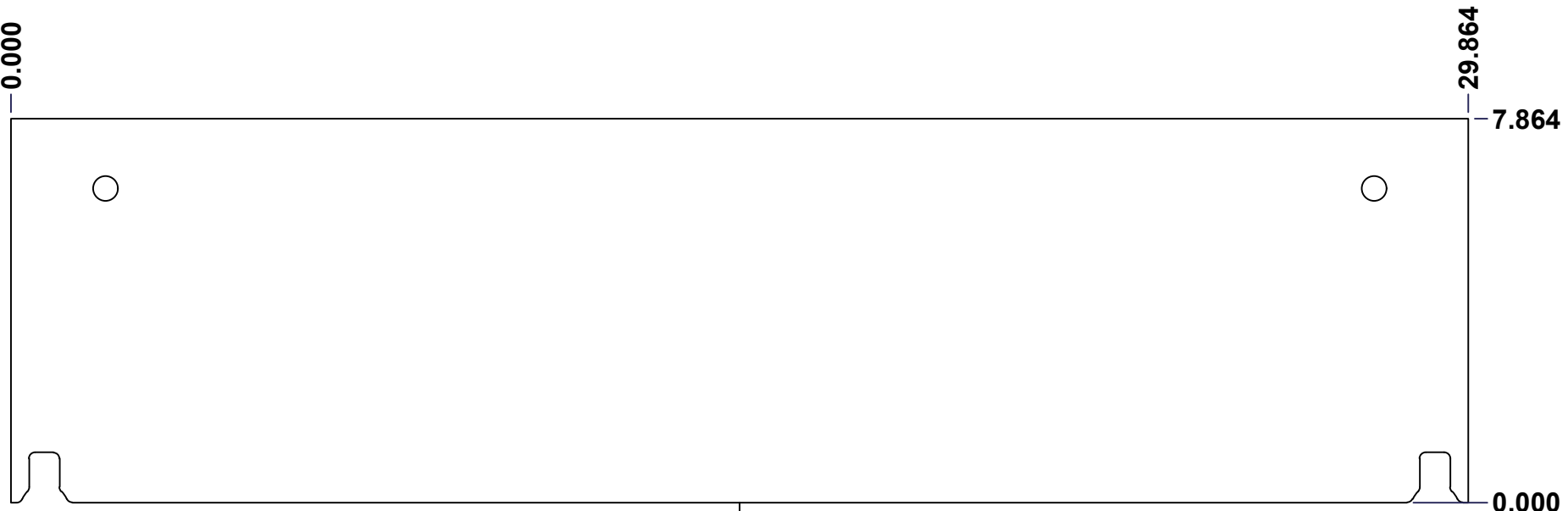

FRONT



RIGHT

No.	Revisions	Date	By/Par

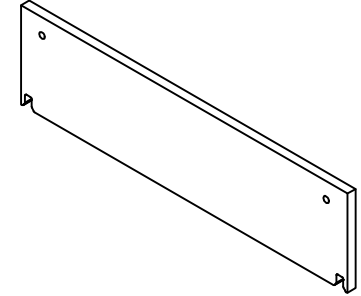

Isometric View



Tél: (450) 979-4373  
 Fax: (450) 979-4626  
[www.exmweb.com](http://www.exmweb.com)

Flatness  
Aplatissement  
Max 3.0mm  
Projection

Customer Client	Date
Drawn By / Dessiné Par: BoxCad: Patrick Deschenes	Date: 23-Jan-07
Material / Matière: Polyisocyanurate	
Color / Couleur: Aluminum	Finish / Fini: N/A
Description: 5412ESSW 36" x 30" Top and Bottom Insulation	Detail Rev.

Part Number / Numéro Pièce: 5412ESSW3630086THNOIP-TP0	Rev. 14
---	---------

SEE BILL OF MATERIAL ON LAST PAGE

This drawing is confidential and must not be reproduced or used without the consent of EXM

Ce dessin est confidentiel et ne doit pas être reproduit ou utilisé sans le consentement de EXM

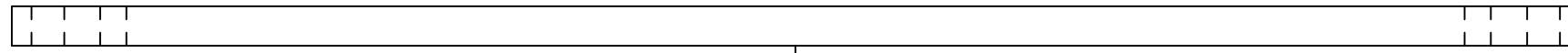

TOP

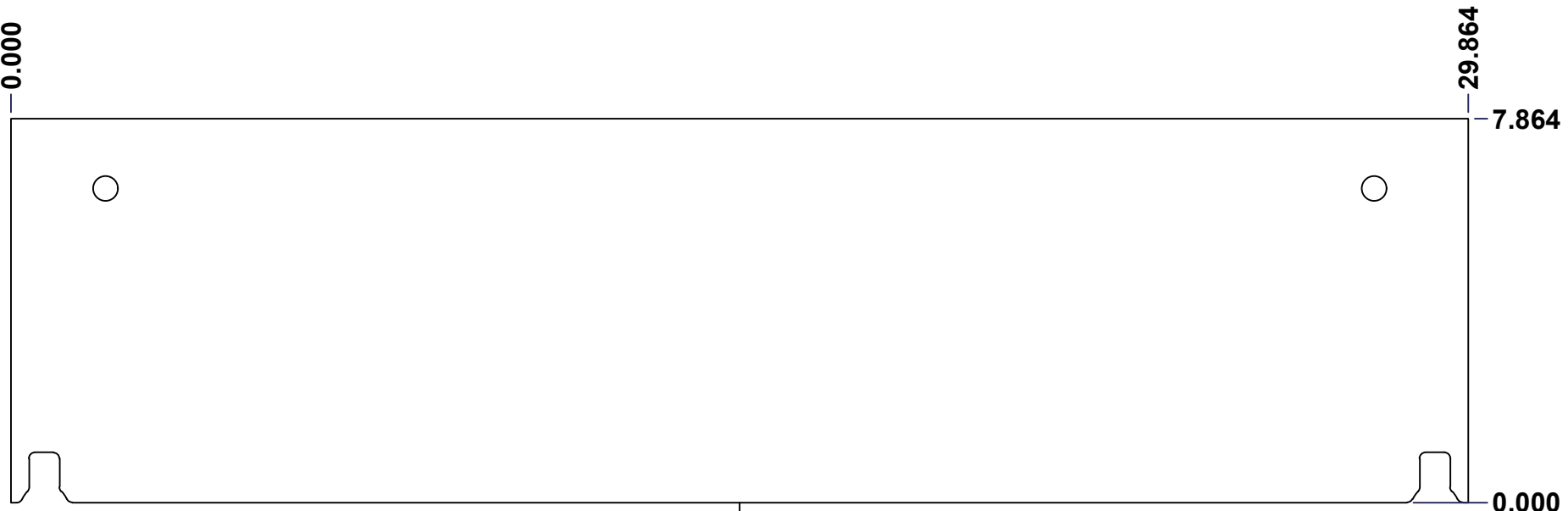

FRONT



RIGHT

No.	Revisions	Date	By/Par

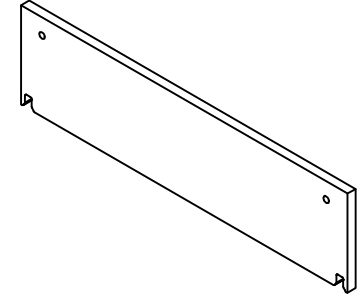

Isometric View



Tél: (450) 979-4373  
 Fax: (450) 979-4626  
[www.exmweb.com](http://www.exmweb.com)

Flatness  
Aplatissement  
Max 3.0mm  
Projection

Customer Client	Date
Drawn By / Dessiné Par: BoxCad: Patrick Deschenes	Date: 23-Jan-07
Material / Matière: Polyisocyanurate	
Color / Couleur: Aluminum	Finish / Fini: N/A
Description: 5412ESSW 36" x 30" Top and Bottom Insulation	Detail Rev.

Part Number / Numéro Pièce	Rev.	15
----------------------------	------	----

SEE BILL OF MATERIAL ON LAST PAGE 5412ESSW3630086THNOIP-BT0