

This drawing is confidential and must not be reproduced or used without the consent of EXM

Ce dessin est confidentiel et ne doit pas être reproduit ou utilisé sans le consentement de EXM

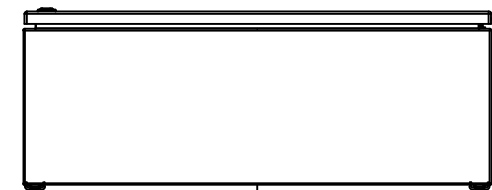

TOP

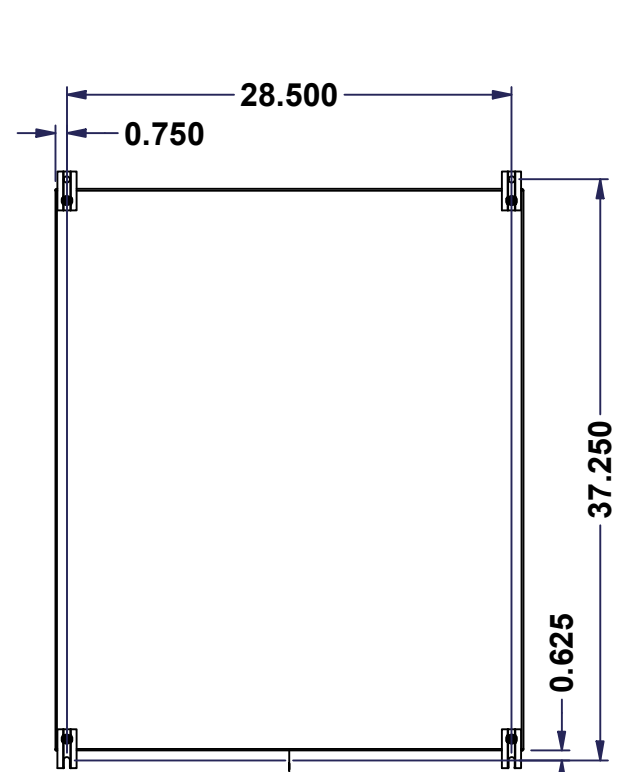

BACK

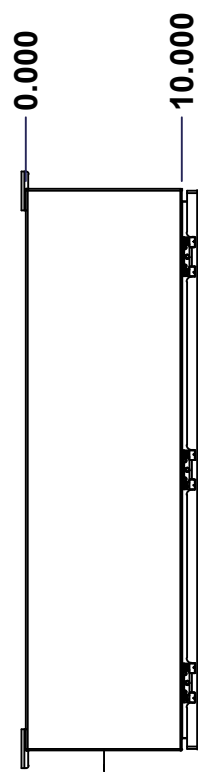

LEFT

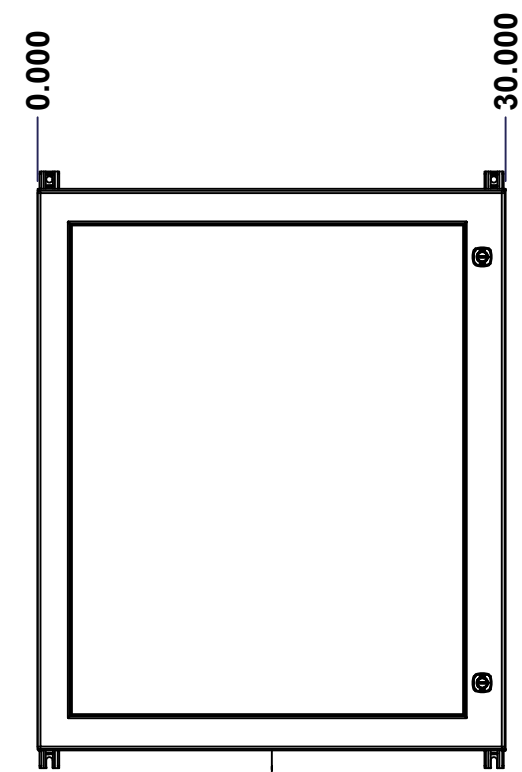

FRONT

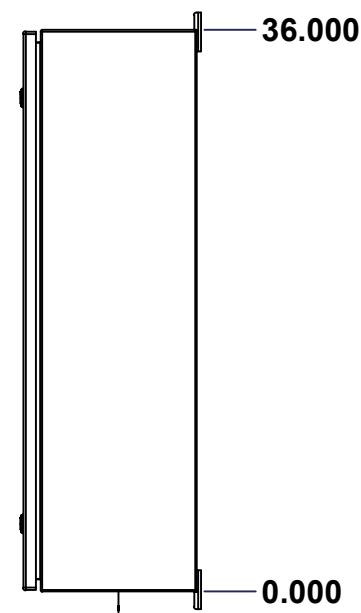

RIGHT

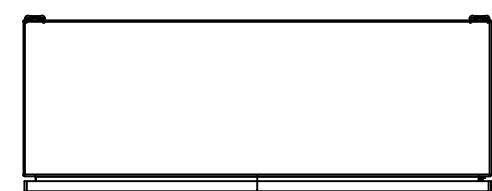

BOTTOM

No.	Revisions	Date	By/Par

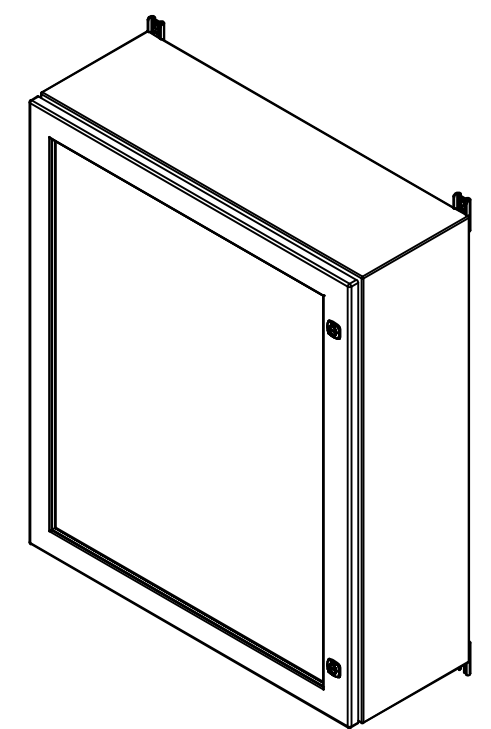

Isometric View



**GRAIN DIRECTION:
TOP/BOTTOM: HORIZONTAL
LEFT/RIGHT/BACK/FRONT: VERTICAL**

	Flatness Aplatissement Max 3.0mm
	Projection
Customer Client	Date
Drawn By Dessiné Par BoxCad: BoxCad	Date 08-Jun-23
Material Matière 14 Ga Stainless Steel 316 (1.7mm)	
Color Couleur Unpainted	Finish Fini Brushed
Description 5412ESSW 36" x 30" x 10" Assembly	
Part Number Numéro Pièce	Detail Rev. Rev. 1
SEE BILL OF MATERIAL ON LAST PAGE 5412ESSW3630106THNOIP	

This drawing is confidential and must not be reproduced or used without the consent of EXM

Ce dessin est confidentiel et ne doit pas être reproduit ou utilisé sans le consentement de EXM

NOTE	
ITEM	DESCRIPTION
1	NEMA 4X Enclosure
2	C/W Standard ground studs on box and cover
3	W/O Standard door stiffener
4	W/O Inner panel
5	C/W Standard inner panel mounting studs
6	C/W 885 ESMF4_OPEN Sold separately (Installed)
7	C/W 885 ESMF4_CLOSE Sold separately (Installed)
8	C/W R5 Insulation (Installed by EXM)

No.	Revisions	Date	By/Par

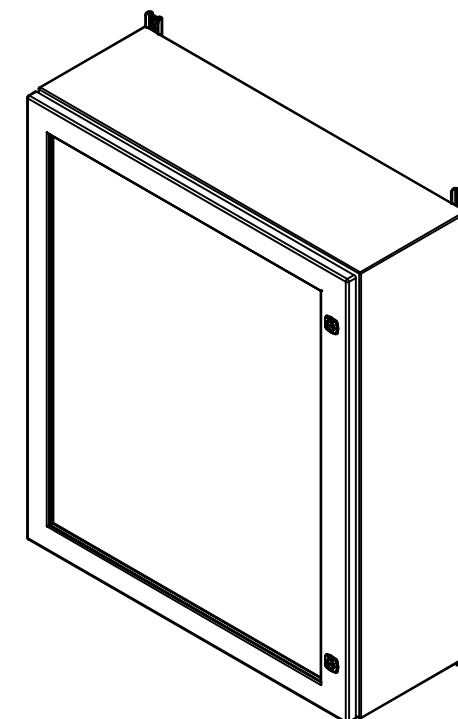

Isometric View



Tél: (450) 979-4373
 Fax: (450) 979-4626
www.exmweb.com

Flatness
Aplatissement
Max 3.0mm
Projection

Customer Client	Date
Drawn By Dessiné Par BoxCad: BoxCad	Date 08-Jun-23

Material
Matière 14 Ga Stainless Steel 316 (1.7mm)

Color Couleur Unpainted	Finish Fini Brushed
----------------------------	------------------------

Description
5412ESSW 36" x 30" x 10" Assembly

Part Number Numéro Pièce	Rev.	2
5412ESSW3630106THNOIP	0	15

Qty	Part Number	Rev	Description
6	STK-Q-00600	2	M12 to M8 Adaptor
1	STK-K-01800	5	5412 ES Accessory Kit
1	5412ESSW3630106THNO IPC	0	5412ESSW 36" x 30" Cover
1	5412ESSW3630106THNO IPB	0	5412ESSW 36" x 30" x 10" Body
3	STK-Q-04051-08	1	M6 x 8mm Stainless Steel Hexagon Socket Head Machine Screw with Nyseal
Parts List			

PACKING		
ITEM	QTY	DESCRIPTION
Cardboard sleeve	2	Top and Bottom
Cardboard strip	2	Between back of enclosure and inner panel
Plastic bag	1	To protect cover surface and inside gasket
Plastic strap - Black	2	To Squeeze the 2 cardboard sleeve together
Packaging label	1	White label with product number

This drawing is confidential and must not be reproduced or used without the consent of EXM

Ce dessin est confidentiel et ne doit pas être reproduit ou utilisé sans le consentement de EXM

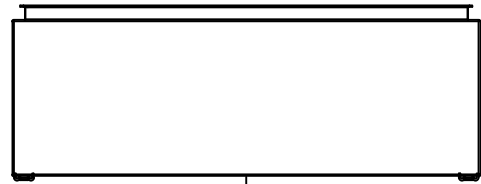

TOP

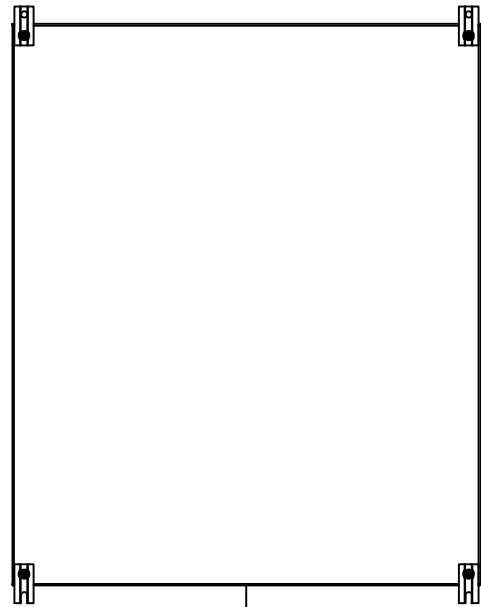

BACK

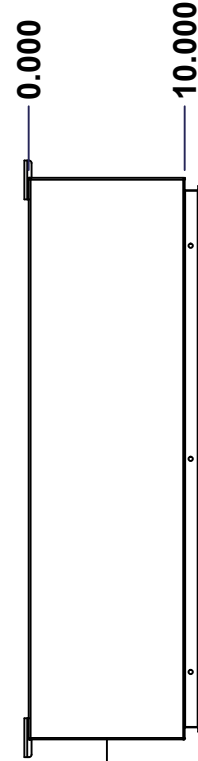

LEFT

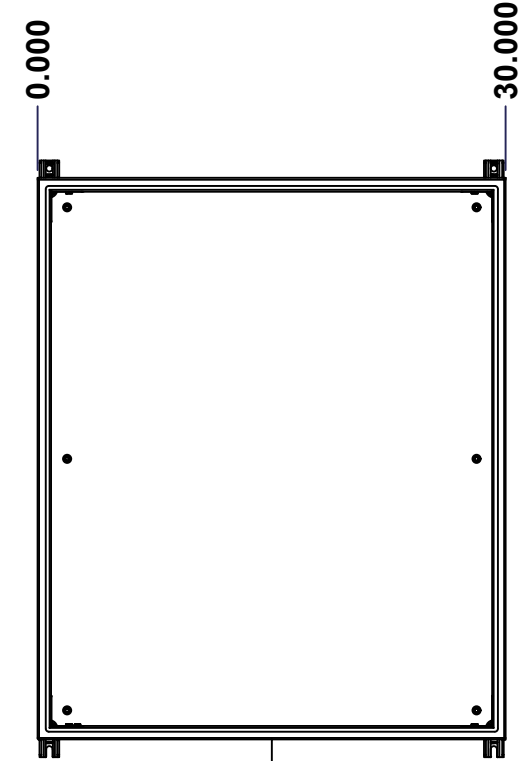

FRONT

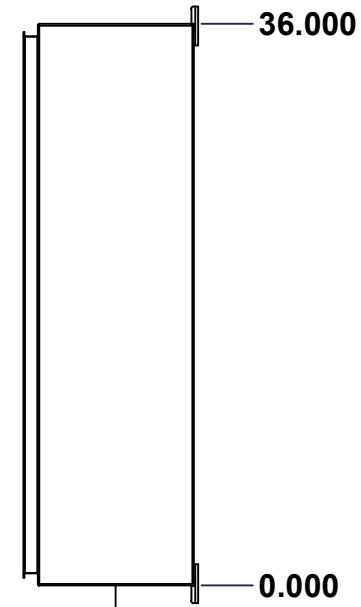

RIGHT

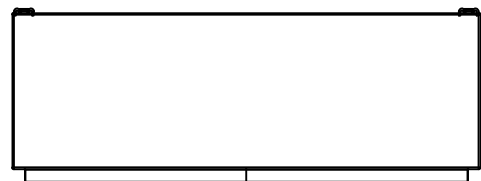

BOTTOM

No.	Revisions	Date	By/Par

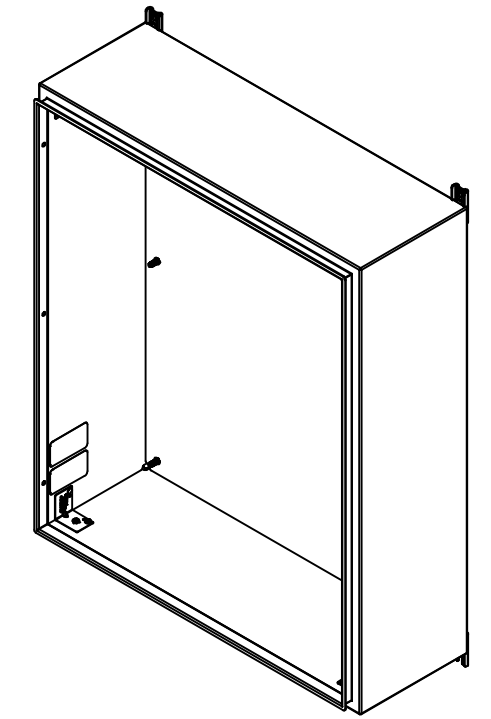

Isometric View



Tél: (450) 979-4373
 Fax: (450) 979-4626
www.exmweb.com

Flatness
Aplatissement
Max 5.0mm
Projection

Customer Client	Date
Drawn By Dessiné Par BoxCad: BoxCad	Date 08-Jun-23
Material Matière 14 Ga Stainless Steel 316 (1.7mm)	
Color Couleur Unpainted	Finish Fini Brushed
Description 5412ESSW 36" x 30" x 10" Body	Detail Rev.
Part Number Numéro Pièce	Rev. 3

This drawing is confidential and must not be reproduced or used without the consent of EXM

Ce dessin est confidentiel et ne doit pas être reproduit ou utilisé sans le consentement de EXM

STANDARD FEATURES ARE NOT LISTED IN THIS HOLE TABLE			
HOLE TABLE - TOP VIEW (CUSTOM FEATURE ONLY)			
CUT-OUT	XDIM	YDIM	DESCRIPTION
1	2.000	8.500	INSUL. STUD M6 x 18mm (Inside)
2	28.000	8.500	INSUL. STUD M6 x 18mm (Inside)

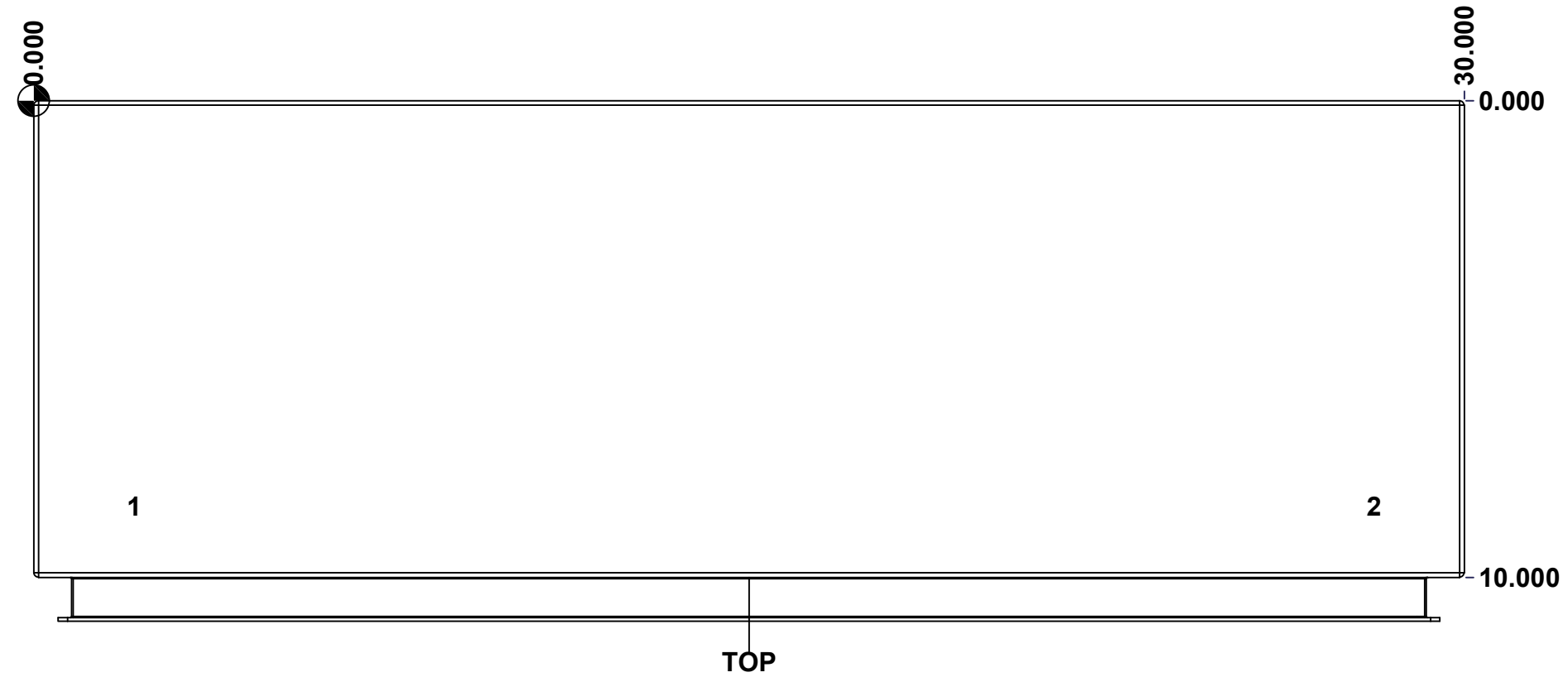

	Description	Status
	5412ESSW 36" x 30" x 10" Body	(NULL)
	Part Number Numéro Pièce	Rev.
	5412ESSW3630106THNOIPB 0	4
		15

This drawing is confidential and must not be reproduced or used without the consent of EXM

Ce dessin est confidentiel et ne doit pas être reproduit ou utilisé sans le consentement de EXM

STANDARD FEATURES ARE NOT LISTED IN THIS HOLE TABLE			
HOLE TABLE - BOTTOM VIEW (CUSTOM FEATURE ONLY)			
CUT-OUT	XDIM	YDIM	DESCRIPTION
1	2.000	8.500	INSUL. STUD M6 x 18mm (Inside)
2	28.000	8.500	INSUL. STUD M6 x 18mm (Inside)

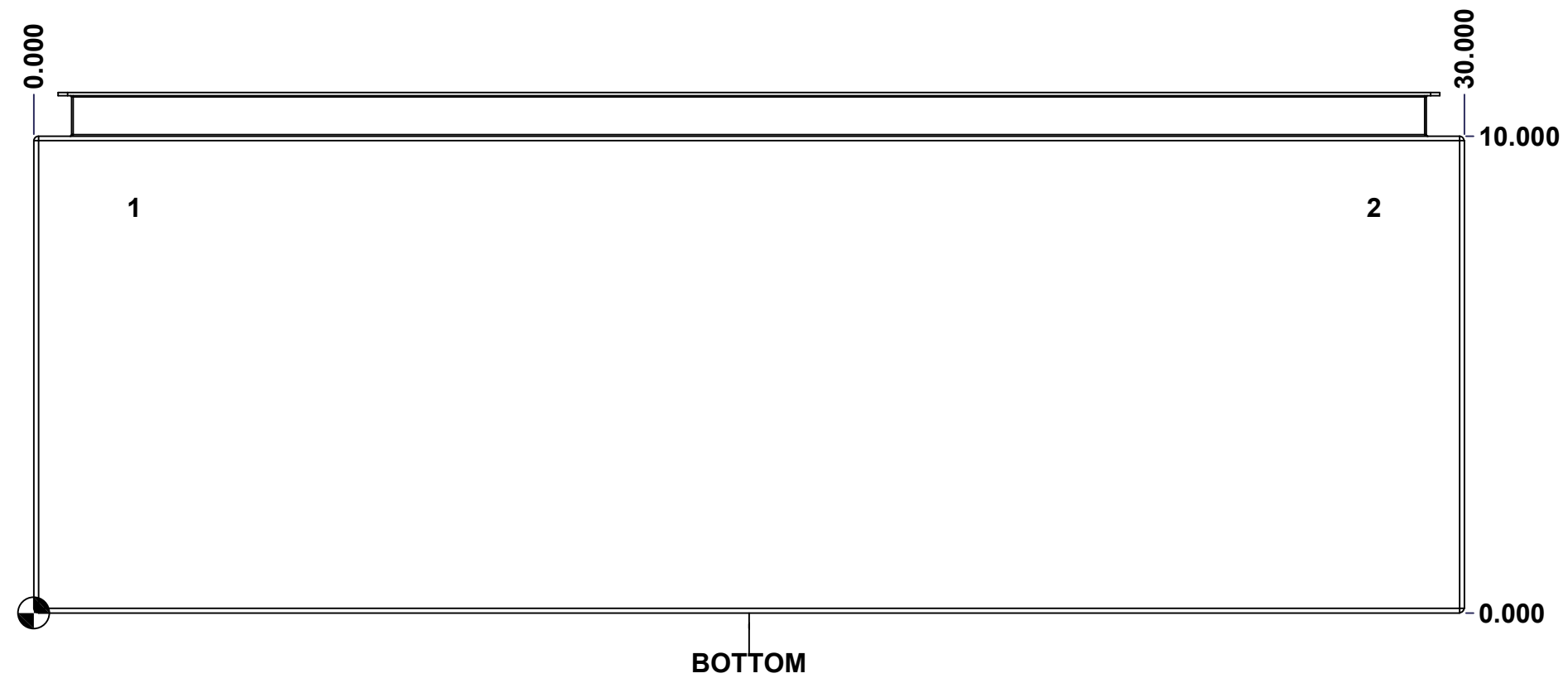

	Description	Status
	5412ESSW 36" x 30" x 10" Body	(NULL)
	Part Number Numéro Pièce	Rev. 5
	5412ESSW3630106THNOIPB 0	15

This drawing is confidential and must not be reproduced or used without the consent of EXM

Ce dessin est confidentiel et ne doit pas être reproduit ou utilisé sans le consentement de EXM

STANDARD FEATURES ARE NOT LISTED IN THIS HOLE TABLE

HOLE TABLE - BACK VIEW (CUSTOM FEATURE ONLY)

CUT-OUT	XDIM	YDIM	DESCRIPTION
1	1.875	1.875	IP STUD M8 x 35mm (Inside)
2	1.875	34.125	IP STUD M8 x 35mm (Inside)
3	28.125	34.125	IP STUD M8 x 35mm (Inside)
4	28.125	1.875	IP STUD M8 x 35mm (Inside)
5	1.875	18.000	IP STUD M8 x 35mm (Inside)
6	28.125	18.000	IP STUD M8 x 35mm (Inside)

7	29.250	0.000	FOOT 885 ESMF4_OPEN
8	0.750	0.000	FOOT 885 ESMF4_OPEN
9	29.250	36.000	FOOT 885 ESMF4_CLOSE
10	0.750	36.000	FOOT 885 ESMF4_CLOSE

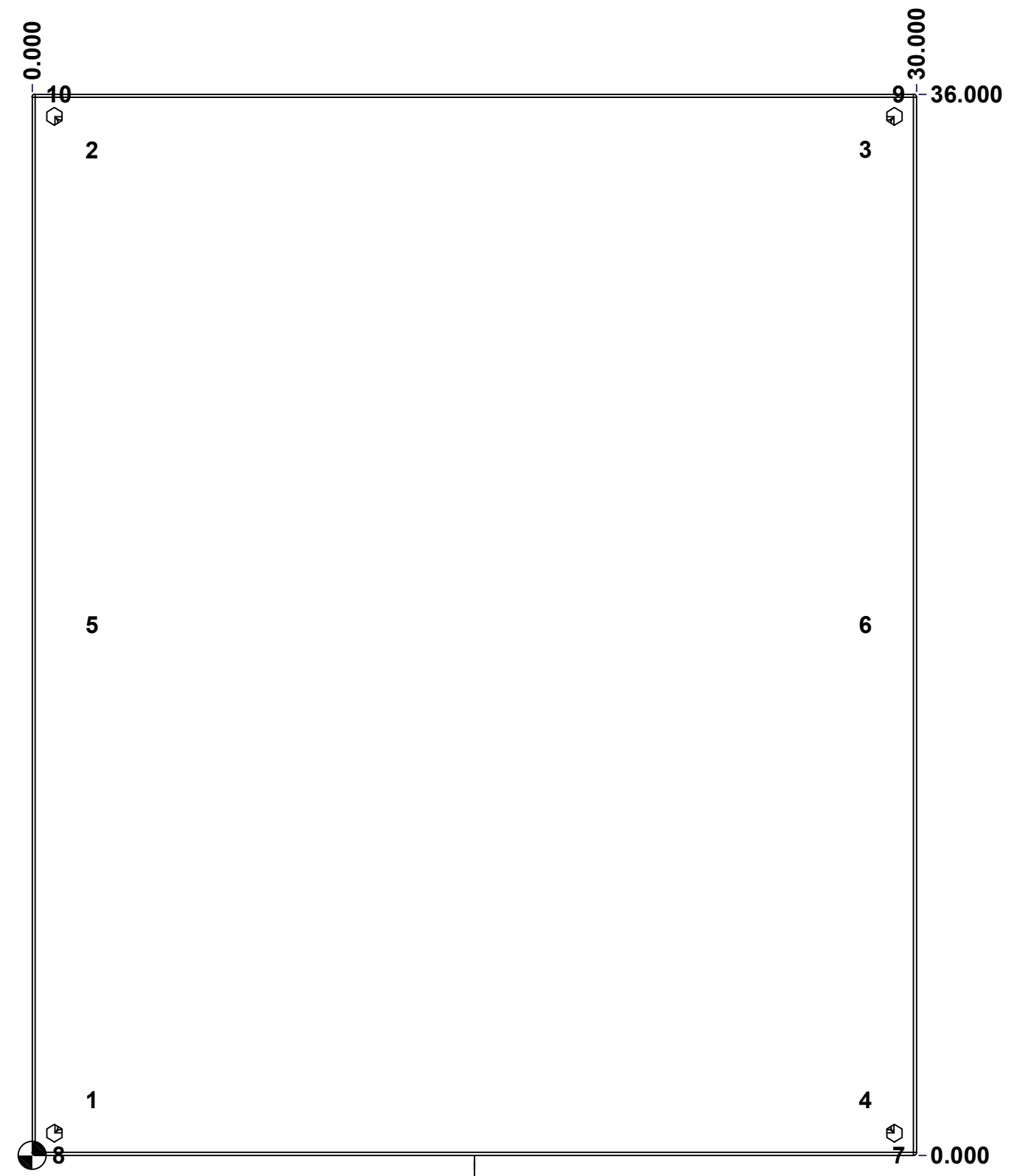

BACK

	Description	Status
	5412ESSW 36" x 30" x 10" Body	(NULL)
	Part Number Numéro Pièce	Rev.
	5412ESSW3630106THNOIPB 0	6
		15

This drawing is confidential and must not be reproduced or used without the consent of EXM

Ce dessin est confidentiel et ne doit pas être reproduit ou utilisé sans le consentement de EXM

No.	Revisions	Date	By/Par

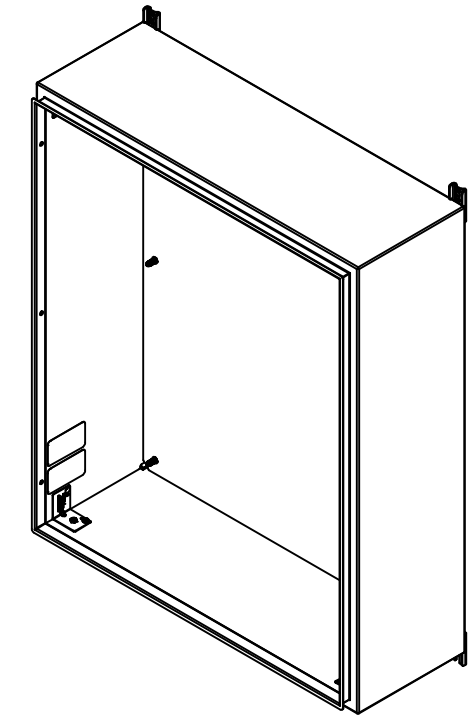

Isometric View



2	885ESMF4-FEET	0	885 ESMF4 Stainless Steel Mounting Foot
4	RIVET_NUT_SS_M10_FH_CE	0	Stainless Steel Rivet Nut M10 (Low Profile Close End)
4	STK-Q-06670	2	M10 x 16mm Stainless Steel Machine Screw
2	885ESMF4-FEET-A	0	885 ESMF4 Stainless Steel Mounting Foot (Opened Slot)
2	STK-S-00100	0	3.5" x 2" Silver Milar Flexcon Sticker
1	STK-K-70554	3	5412 ESTH Accessory Kit
1	5412ESSW3630106THNO IPI-RS	0	5412ESSW 36" x 30" Right Insulation
1	5412ESSW3630106THNO IPI-LS	0	5412ESSW 36" x 30" Left Insulation
1	5412ESSW3630106THNO IPI-BT	0	5412ESSW 36" x 30" Top and Bottom Insulation
1	5412ESSW3630106THNO IPI-TP	0	5412ESSW 36" x 30" Top and Bottom Insulation
1	5412ESSW3630106THNO IPI-B	0	5412ESSW 36" x 30" Back Insulation
4	STK-Q-16070	1	Stud M6 x 18mm Stainless steel
6	STK-Q-16020	1	Stud M8 x 35mm Stainless Steel
1	5412ESSW3630106THNO IPB-P	0	5412ESSW 36" x 30" x 10" Body Part

Qty	Part Number	Rev	Description
Parts List			



Tél: (450) 979-4373
Fax: (450) 979-4626
www.exmweb.com

Flatness
Aplatissement
Max 0.0mm
Projection

Customer Client	Date
Drawn By Dessiné Par: BoxCad: BoxCad	Date: 08-Jun-23
Material Matière: 14 Ga Stainless Steel 316 (1.7mm)	
Color Couleur: Unpainted	Finish Fini: Brushed
Description: 5412ESSW 36" x 30" x 10" Body	Detail Rev.
Part Number Numéro Pièce: 5412ESSW3630106THNOIPB 0	Rev. 7

This drawing is confidential and must not be reproduced or used without the consent of EXM

Ce dessin est confidentiel et ne doit pas être reproduit ou utilisé sans le consentement de EXM

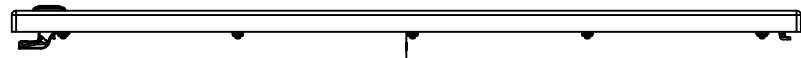

TOP

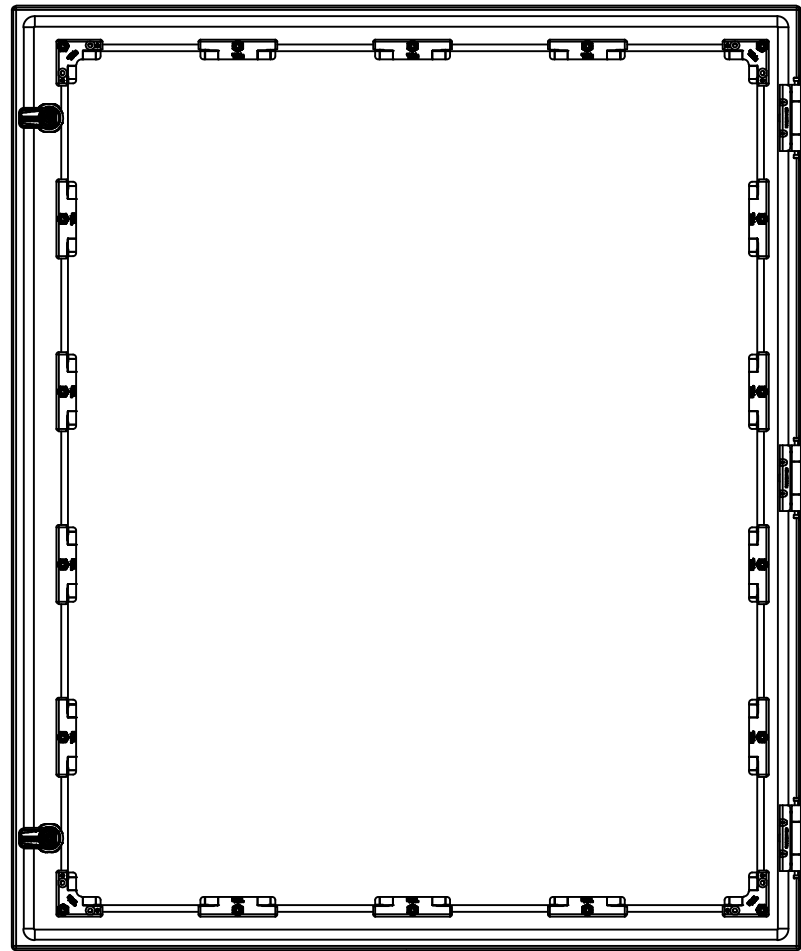

BACK



BOTTOM

0.000
0.800

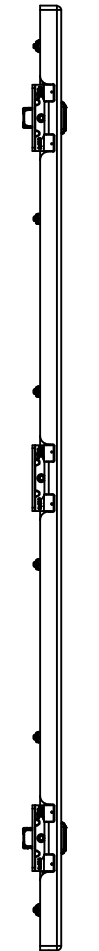

LEFT

0.000
29.918

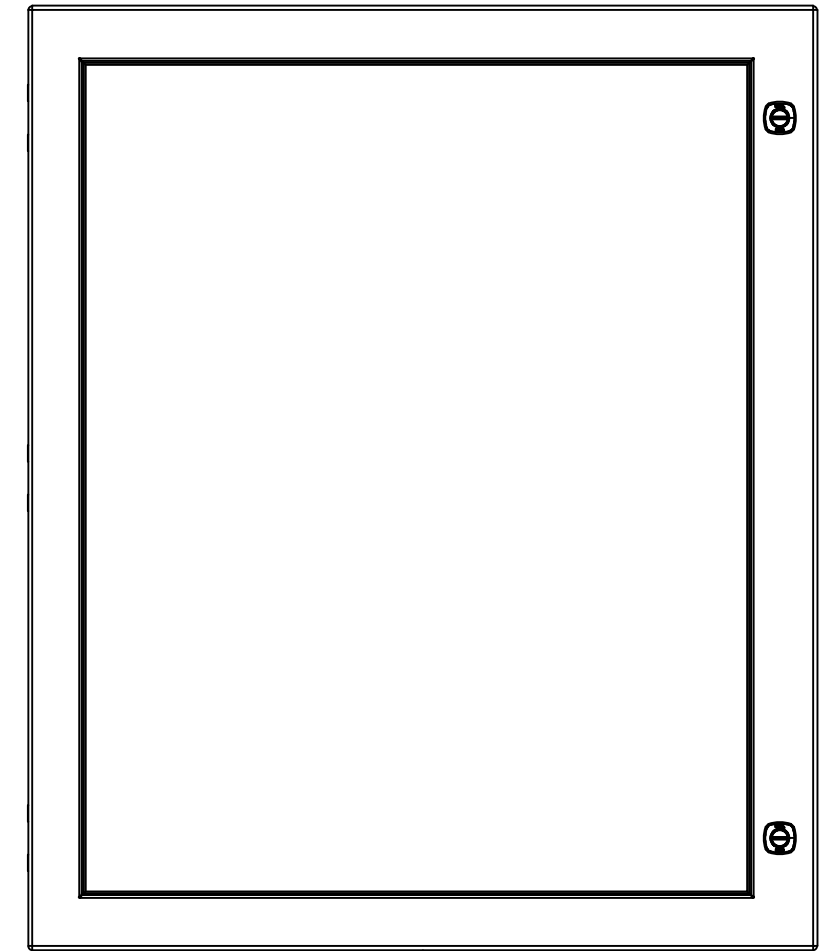

FRONT

35.803

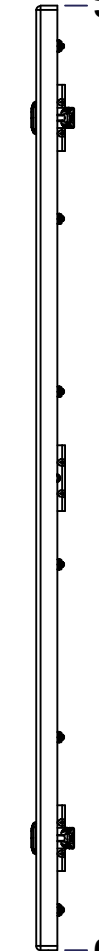

RIGHT

0.000

No.	Revisions	Date	By/Par

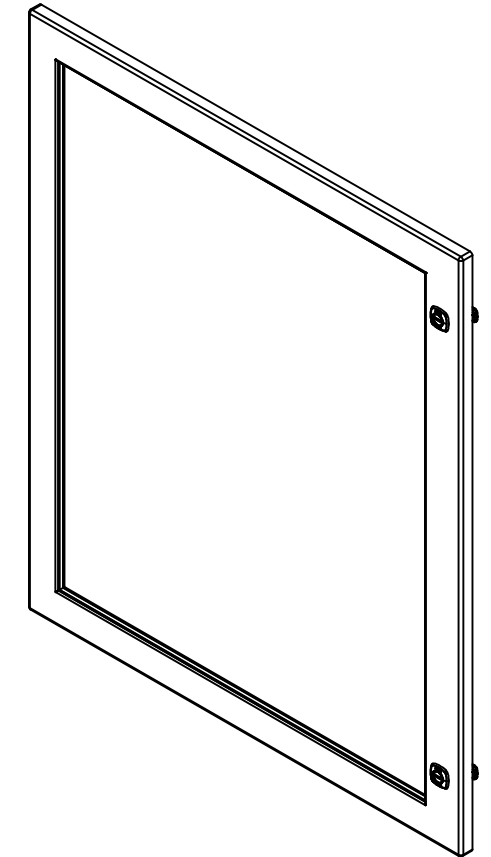

Isometric View



Tél: (450) 979-4373
Fax: (450) 979-4626
www.exmweb.com

Flatness
Aplatissement
Max 5.0mm
Projection

Customer Client	Date
Drawn By Dessiné Par BoxCad: BoxCad	Date 08-Jun-23
Material Matière 14 Ga Stainless Steel 316 (1.7mm)	
Color Couleur Unpainted	Finish Fini Brushed
Description 5412ESSW 36" x 30" Cover	Detail Rev.
Part Number Numéro Pièce	Rev. 8

SEE BILL OF MATERIAL ON LAST PAGE 5412ESSW3630106THNOIPC 0

This drawing is confidential and must not be reproduced or used without the consent of EXM

Ce dessin est confidentiel et ne doit pas être reproduit ou utilisé sans le consentement de EXM

STANDARD FEATURES ARE NOT LISTED IN THIS HOLE TABLE			
HOLE TABLE - FRONT VIEW (CUSTOM FEATURE ONLY)			
CUT-OUT	XDIM	YDIM	DESCRIPTION
1	1.469	8.077	STUD M6 x 18mm (Inside)
2	27.968	8.077	STUD M6 x 18mm (Inside)
3	1.469	14.627	STUD M6 x 18mm (Inside)
4	27.968	14.627	STUD M6 x 18mm (Inside)
5	1.469	21.176	STUD M6 x 18mm (Inside)
6	27.968	21.176	STUD M6 x 18mm (Inside)
7	1.469	27.726	STUD M6 x 18mm (Inside)
8	27.968	27.726	STUD M6 x 18mm (Inside)
9	1.469	34.276	STUD M6 x 18mm (Inside)
10	1.469	1.527	STUD M6 x 18mm (Inside)
11	8.094	34.276	STUD M6 x 18mm (Inside)
12	8.094	1.527	STUD M6 x 18mm (Inside)
13	14.719	34.276	STUD M6 x 18mm (Inside)
14	14.719	1.527	STUD M6 x 18mm (Inside)
15	21.343	34.276	STUD M6 x 18mm (Inside)
16	21.343	1.527	STUD M6 x 18mm (Inside)
17	27.968	34.276	STUD M6 x 18mm (Inside)
18	27.968	1.527	STUD M6 x 18mm (Inside)

19	28.494	31.553	880 SCQ4-SLSS6
20	28.494	4.250	880 SCQ4-SLSS6

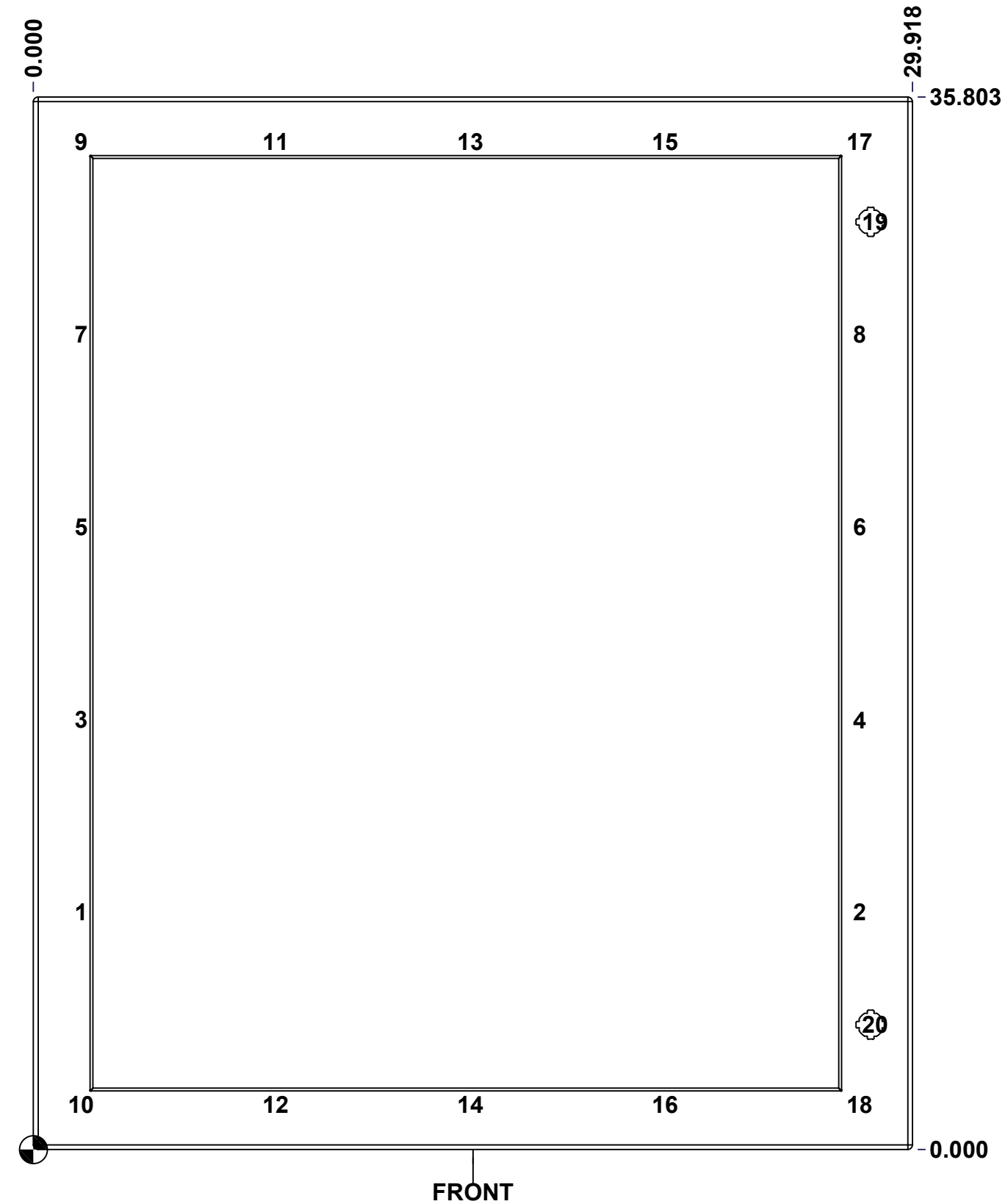

	Description	Status
	5412ESSW 36" x 30" Cover	(NULL)
	Part Number	Rev.
	Numéro Pièce	9
	5412ESSW3630106THNOIPC 0	15

This drawing is confidential and must not be reproduced or used without the consent of EXM

Ce dessin est confidentiel et ne doit pas être reproduit ou utilisé sans le consentement de EXM

No.	Revisions	Date	By/Par

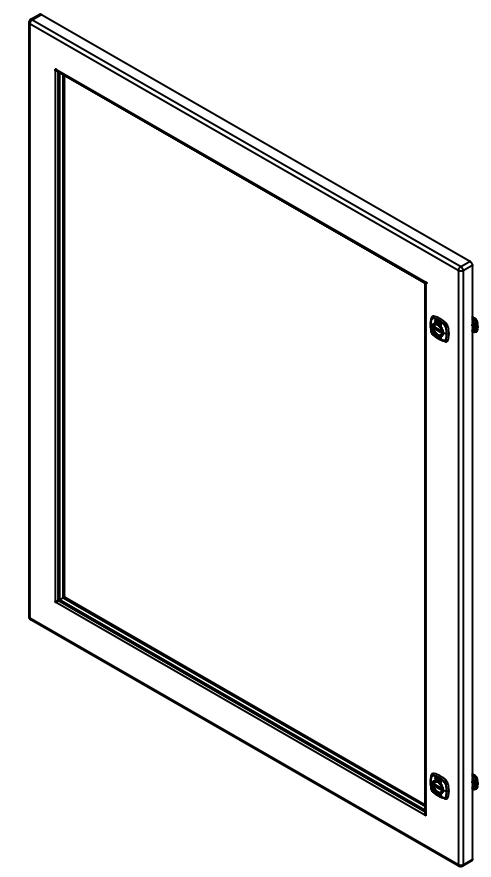

Isometric View

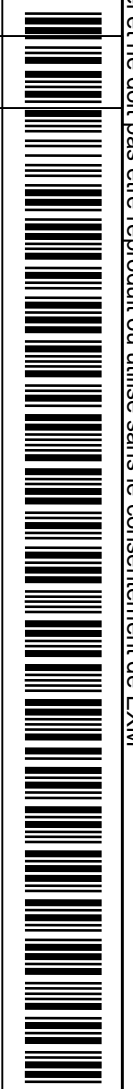

QTY	Part Number	Rev	Description
14	STK-Q-60701	2.1	880 WK - Lexan 1/4" Fixing Bracket
1	STK-A-60703	0	5412 ESW Lexan Bracket Kit
18	STK-Q-16053	1	Stud M6 x 23mm Stainless steel
1	STK-G-02710	0	880 HWKG - Windows Kit Gasket
1	5412ESSW3630106THNO IPLXG	0	5412ESSW 36" x 30" Lexan Gasket Part
1	5412ESSW3630106THNO IPLX	0	5412ESSW 32.375" x 26.125" Lexan Part
1	5412ESSW3630106THNO IPG	0	5412ESSW 36" x 30" Cover Gasket Part
1	5412ESSW3630106THNO IPC-P	0	5412ESSW 36" x 30" Cover Part
2	880 SCQ4-SLSS6	7	5412 ESS 1/4 Turn Lock
3	STK-A-33016	0	5412 ESS Bended Hinge (Body Part)



Tél: (450) 979-4373
Fax: (450) 979-4626
www.exmweb.com

Flatness
Aplatissement
Max 5.0mm
Projection

Customer Client	Date
Drawn By Dessiné Par BoxCad: BoxCad	Date 08-Jun-23
Material Matière 14 Ga Stainless Steel 316 (1.7mm)	
Color Couleur Unpainted	Finish Fini Brushed
Description 5412ESSW 36" x 30" Cover	Detail Rev.
Part Number Numéro Pièce 5412ESSW3630106THNOIPC 0	Rev. 10

This drawing is confidential and must not be reproduced or used without the consent of EXM

Ce dessin est confidentiel et ne doit pas être reproduit ou utilisé sans le consentement de EXM

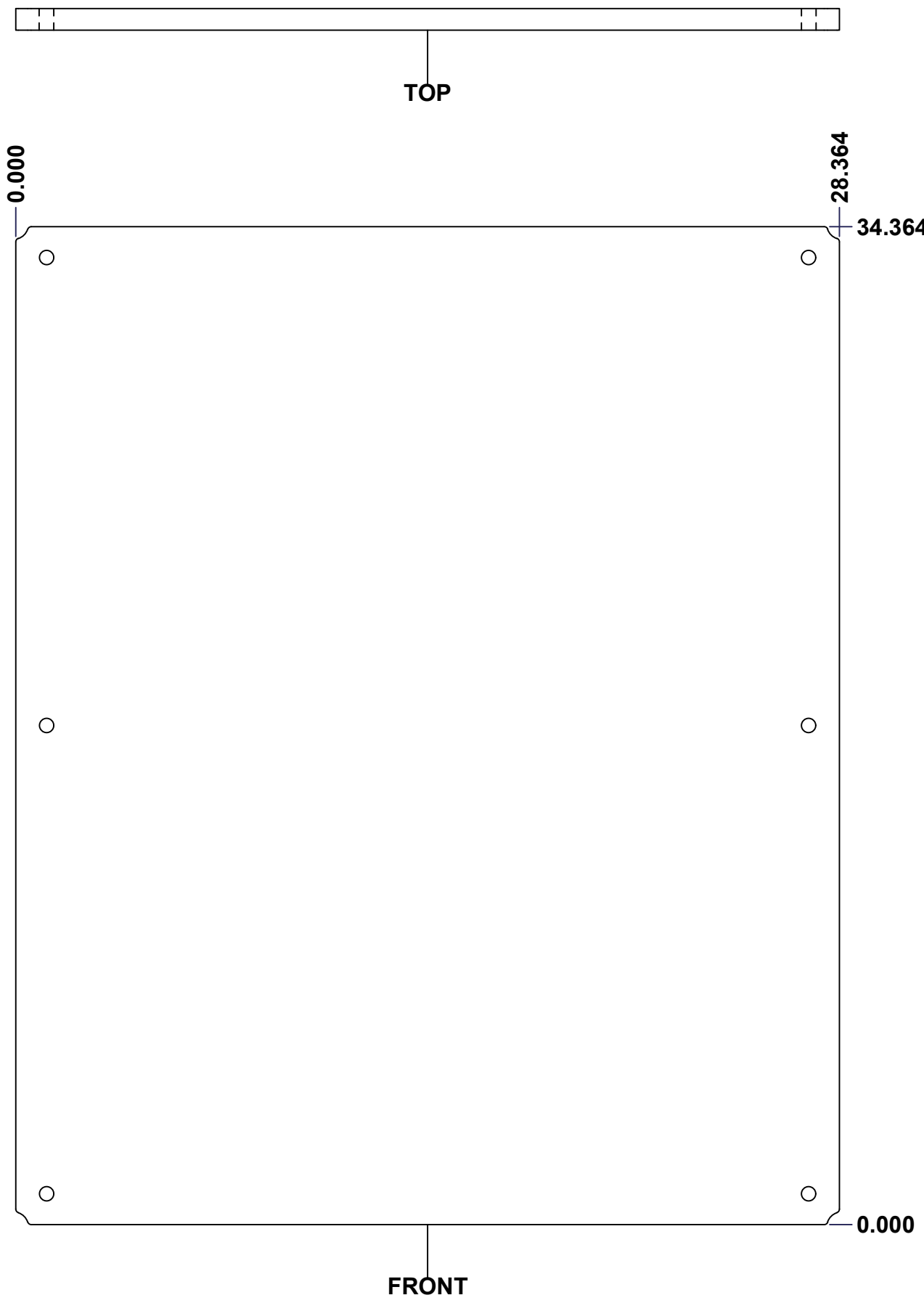

No.	Revisions	Date	By/Par

Isometric View

<p>Tél: (450) 979-4373 Fax: (450) 979-4626 www.exmweb.com</p>		Flatness Aplatissement
		Max 3.0mm
Projection		
Customer Client	Date	
Drawn By Dessiné Par	BoxCad: Patrick Deschenes	Date 23-Jan-07
Material Matière	Polyisocyanurate	
Color Couleur	Aluminum	Finish Fini N/A
Description	Detail Rev.	
5412ESSW 36" x 30" Back Insulation		
Part Number Numéro Pièce	Rev.	11
SEE BILL OF MATERIAL ON LAST PAGE 5412ESSW3630106THNOIPI-B 0		15

This drawing is confidential and must not be reproduced or used without the consent of EXM

Ce dessin est confidentiel et ne doit pas être reproduit ou utilisé sans le consentement de EXM

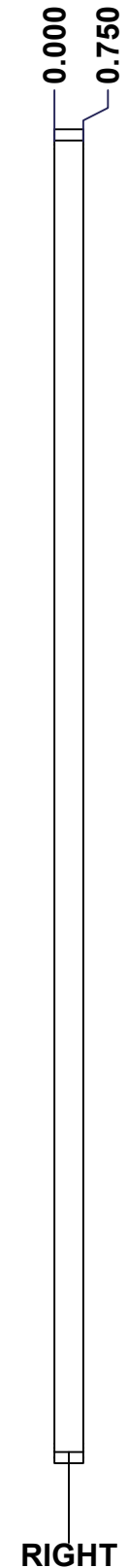
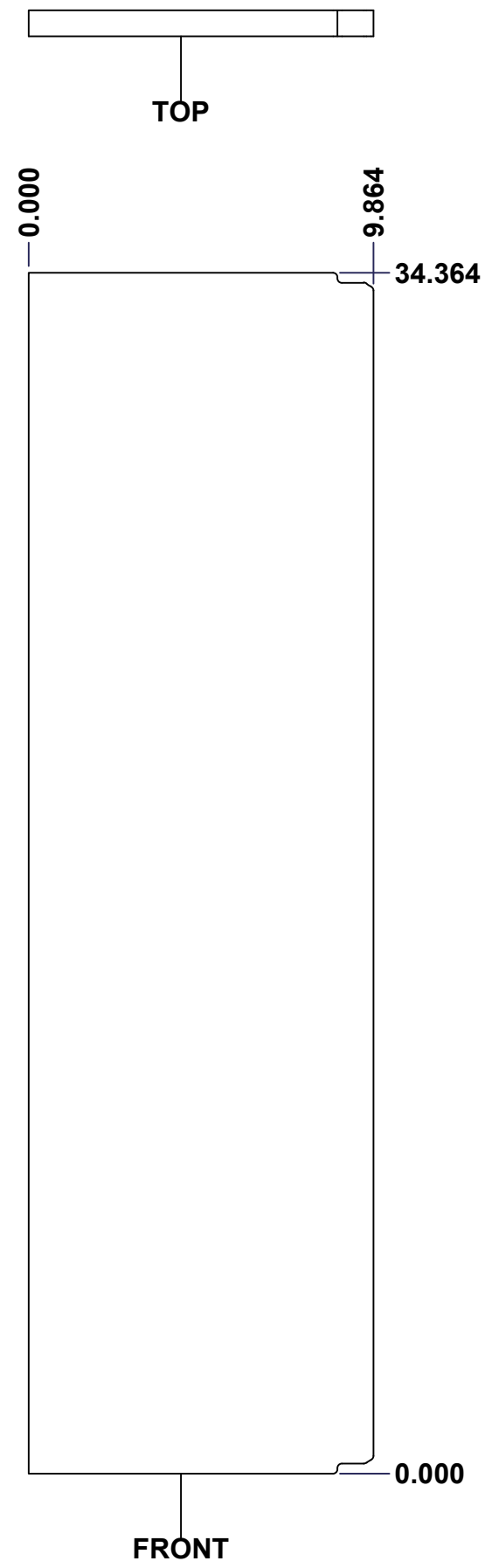

No.	Revisions	Date	By/Par

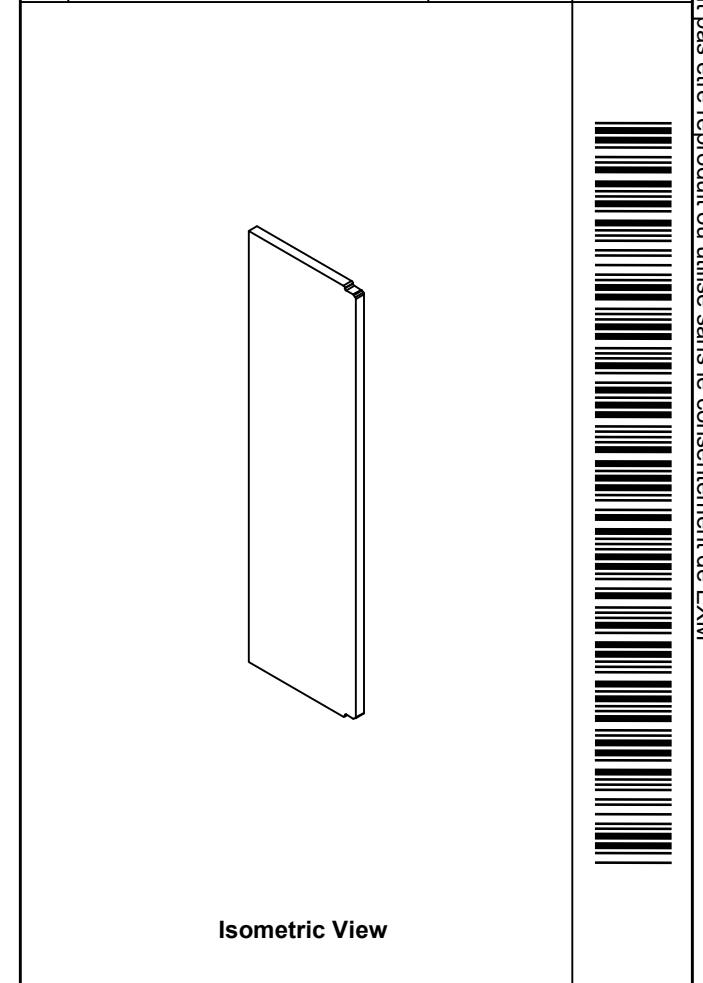

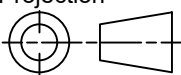
 Tél: (450) 979-4373 Fax: (450) 979-4626 www.exmweb.com		Flatness Aplatissement Max 3.0mm
Projection 		Date 23-Jan-07
Customer Client	Date	
Drawn By / Dessiné Par: BoxCad: Patrick Deschenes	Date: 23-Jan-07	
Material / Matière: Polyisocyanurate		
Color / Couleur: Aluminum	Finish / Fini: N/A	
Description: 5412ESSW 36" x 30" Left Insulation	Detail Rev.	
Part Number / Numéro Pièce: 5412ESSW3630106THNOIP-L	Rev.:	12
SEE BILL OF MATERIAL ON LAST PAGE		15

SEE BILL OF MATERIAL ON LAST PAGE 5412ESSW3630106THNOIP-L S0

This drawing is confidential and must not be reproduced or used without the consent of EXM

Ce dessin est confidentiel et ne doit pas être reproduit ou utilisé sans le consentement de EXM

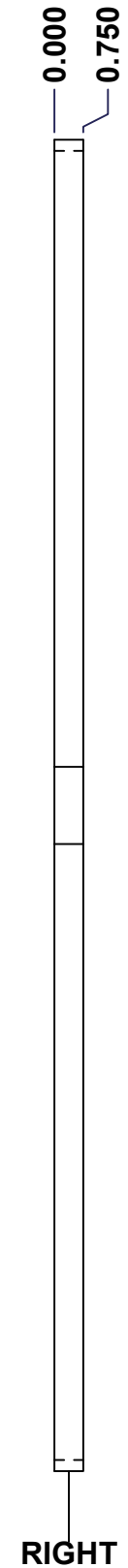
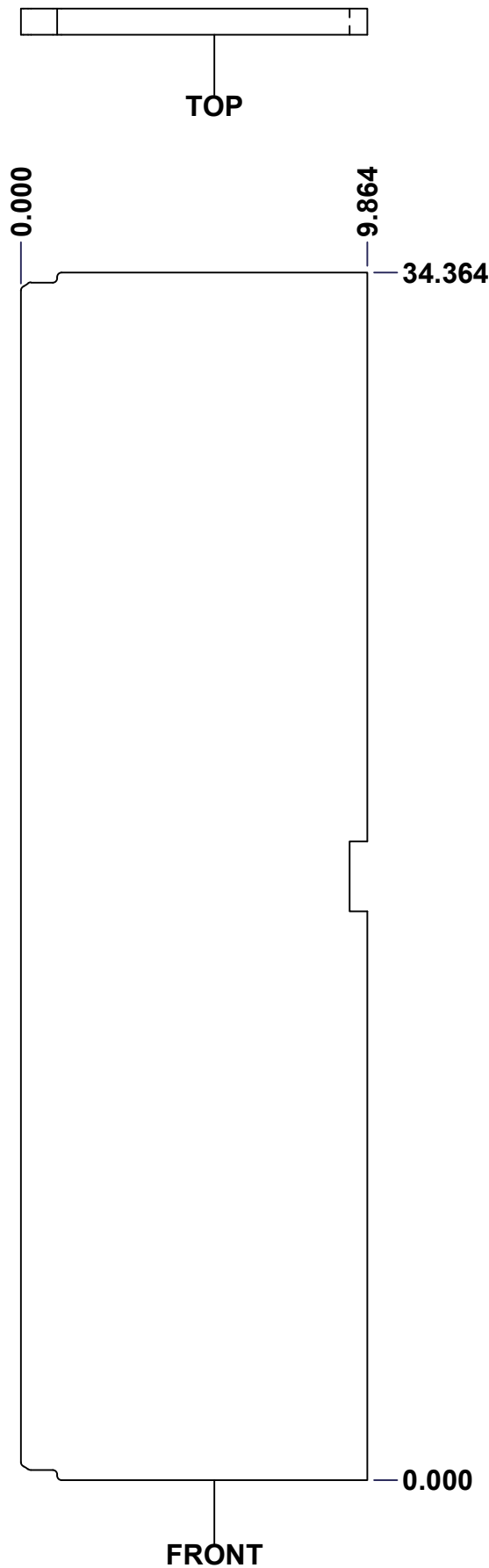

No.	Revisions	Date	By/Par

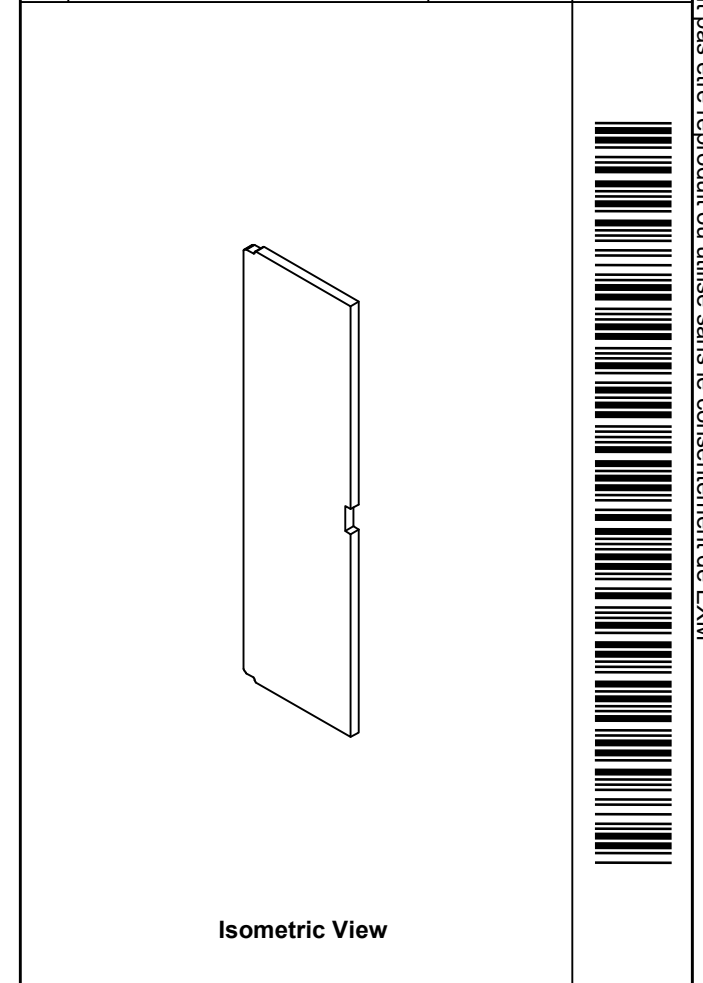

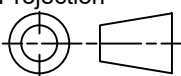
 Tél: (450) 979-4373 Fax: (450) 979-4626 www.exmweb.com		Flatness Aplatissement Max 3.0mm
Customer Client		Projection 
Drawn By / Dessiné Par: BoxCad: Patrick Deschenes		Date: 23-Jan-07
Material / Matière: Polyisocyanurate		
Color / Couleur: Aluminum	Finish / Fini: N/A	
Description: 5412ESSW 36" x 30" Right Insulation		Detail Rev.
Part Number / Numéro Pièce: 5412ESSW3630106THNOIP-RS0		Rev. 13

SEE BILL OF MATERIAL ON LAST PAGE 5412ESSW3630106THNOIP-RS0 15

This drawing is confidential and must not be reproduced or used without the consent of EXM

Ce dessin est confidentiel et ne doit pas être reproduit ou utilisé sans le consentement de EXM

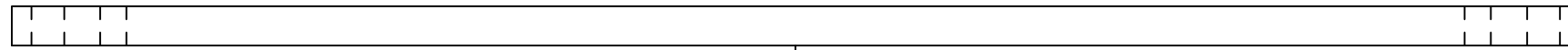

TOP

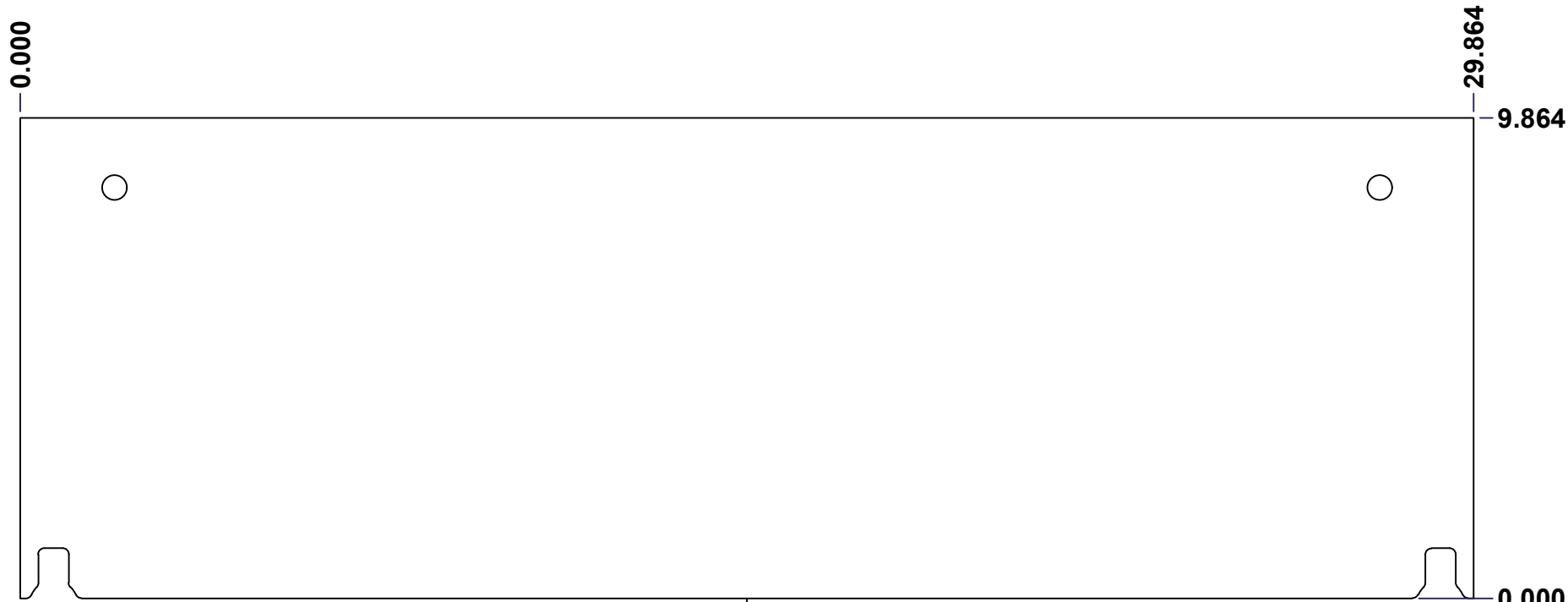

FRONT

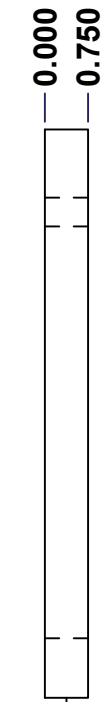

RIGHT

No.	Revisions	Date	By/Par

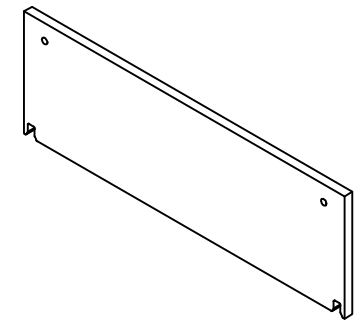

Isometric View



Tél: (450) 979-4373
 Fax: (450) 979-4626
www.exmweb.com

Flatness
Aplatissement

Max 3.0mm

Projection

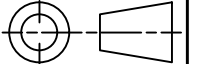

Customer Client	Date
Drawn By / Dessiné Par: BoxCad: Patrick Deschenes	Date: 23-Jan-07
Material / Matière: Polyisocyanurate	
Color / Couleur: Aluminum	Finish / Fini: N/A
Description: 5412ESSW 36" x 30" Top and Bottom Insulation	Detail Rev.

Part Number / Numéro Pièce: 5412ESSW3630106THNOIPI-TP0	Rev. 14
--	---------

SEE BILL OF MATERIAL ON LAST PAGE

This drawing is confidential and must not be reproduced or used without the consent of EXM

Ce dessin est confidentiel et ne doit pas être reproduit ou utilisé sans le consentement de EXM

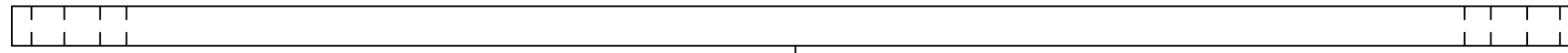

TOP

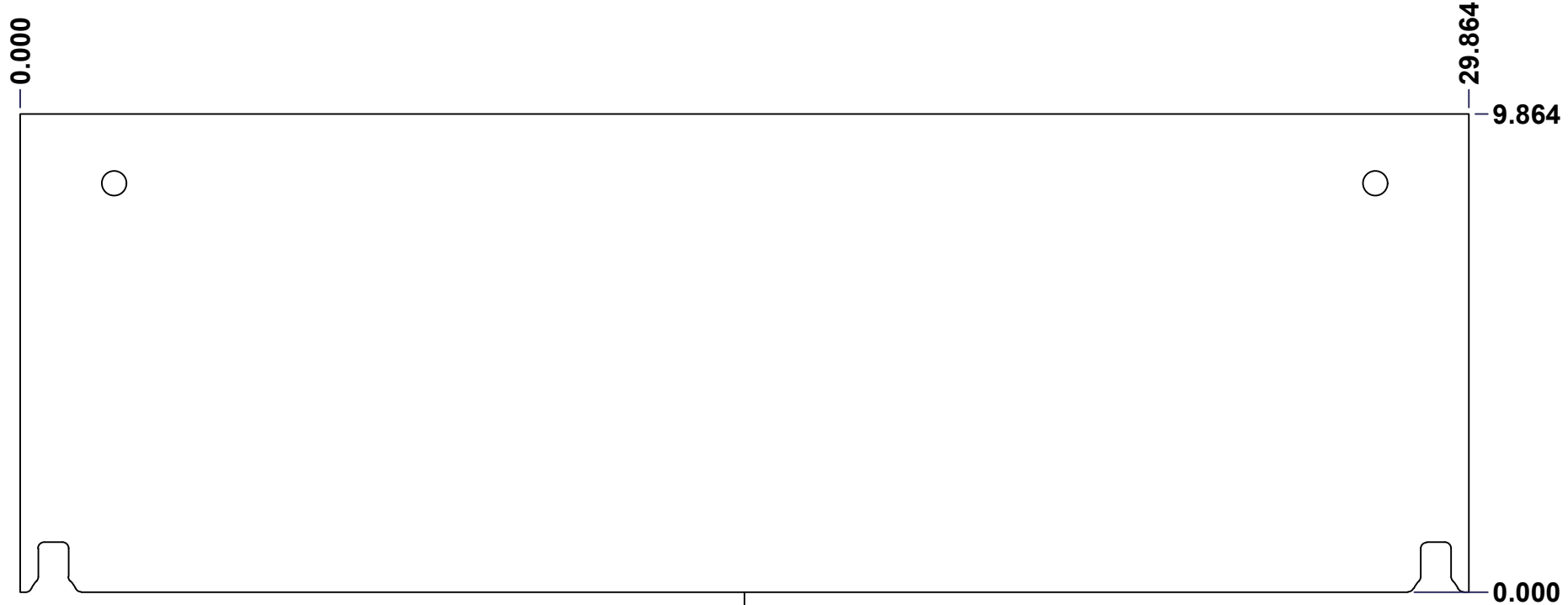

FRONT

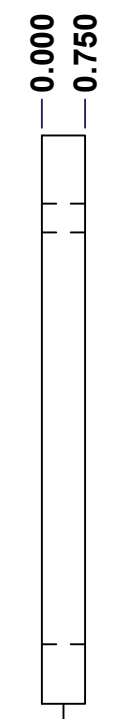

RIGHT

No.	Revisions	Date	By/Par

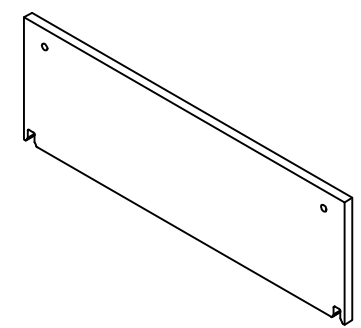

Isometric View



Tél: (450) 979-4373
 Fax: (450) 979-4626
www.exmweb.com

Flatness
Aplatissement
Max 3.0mm
Projection

Customer Client	Date
Drawn By Dessiné Par BoxCad: Patrick Deschenes	Date 23-Jan-07
Material Matière Polyisocyanurate	
Color Couleur Aluminum	Finish Fini N/A
Description 5412ESSW 36" x 30" Top and Bottom Insulation	Detail Rev.

Part Number Numéro Pièce	Rev.	15
-----------------------------	------	----

SEE BILL OF MATERIAL ON LAST PAGE 5412ESSW3630106THNOIPI-BT0