

This drawing is confidential and must not be reproduced or used without the consent of EXM

Ce dessin est confidentiel et ne doit pas être reproduit ou utilisé sans le consentement de EXM

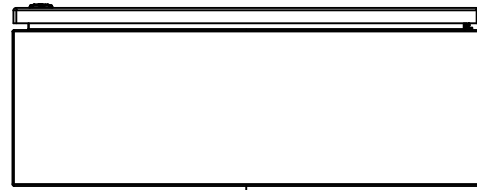

TOP

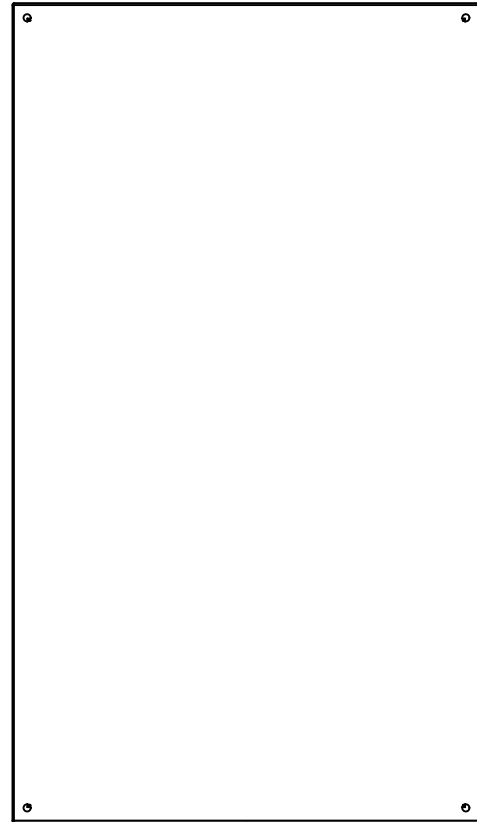

BACK

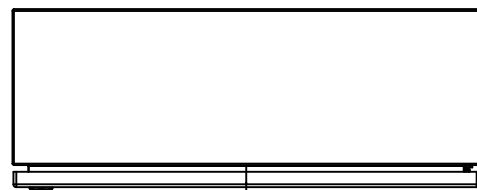

BOTTOM

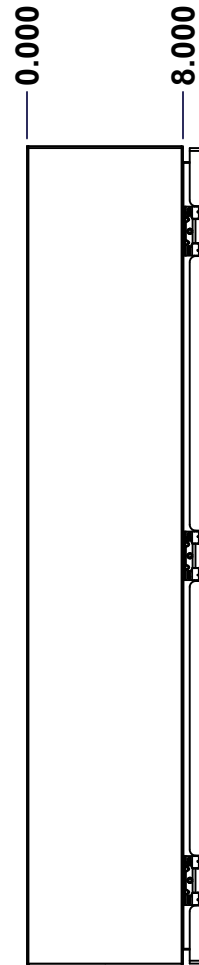

LEFT

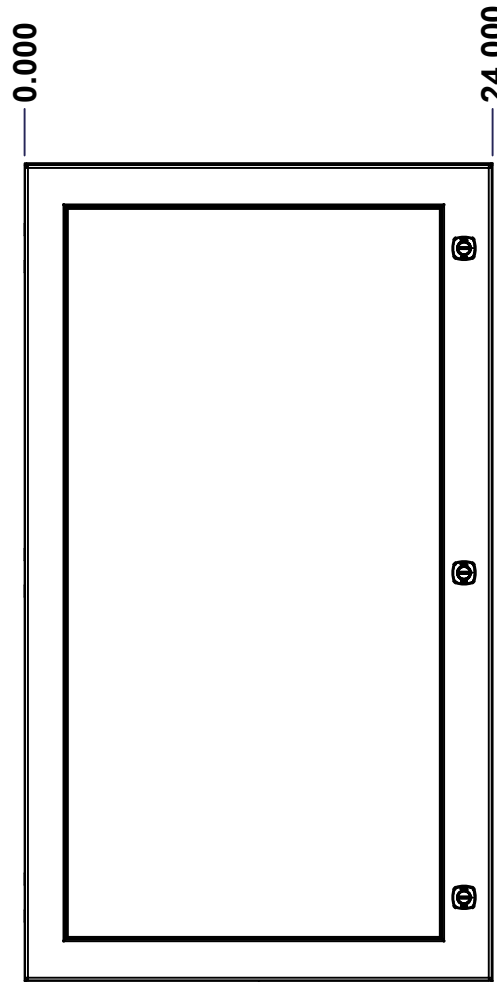

FRONT

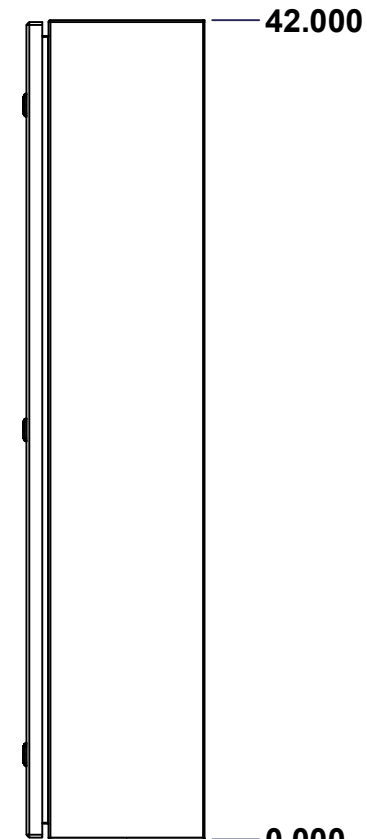

RIGHT

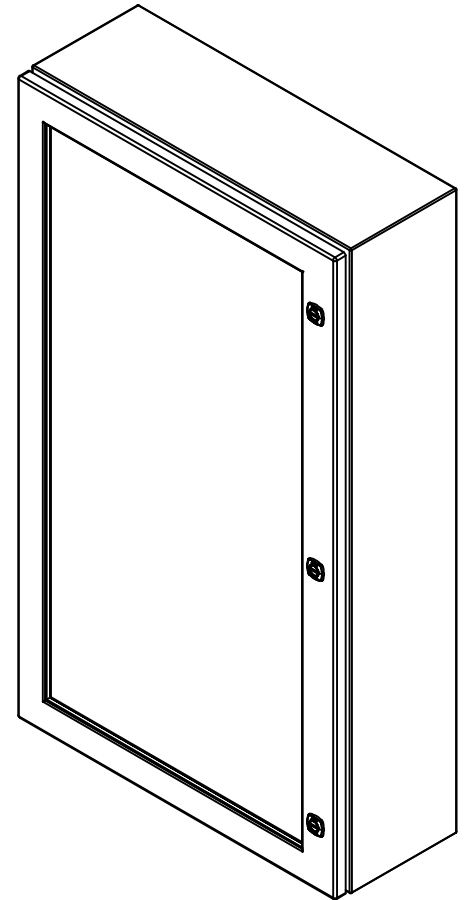

Isometric View



**GRAIN DIRECTION:  
TOP/BOTTOM: HORIZONTAL  
LEFT/RIGHT/BACK/FRONT: VERTICAL**

SEE BILL OF MATERIAL ON LAST PAGE

No.	Revisions	Date	By/Par

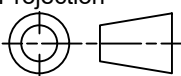
 Tél: (450) 979-4373 Fax: (450) 979-4626 <a href="http://www.exmweb.com">www.exmweb.com</a>		Flatness Aplatissement Max 3.0mm Projection 
Customer Client	Date	
Drawn By Dessiné Par	BoxCad: BoxCad	Date 22-Jun-23
Material Matière	16 Ga Stainless Steel 316 (1.4mm)	
Color Couleur	Unpainted	Finish Fini Brushed
Description	Detail Rev.	
5412ESSW 42" x 24" x 8" Assembly		
Part Number Numéro Pièce	Rev.	1
5412ESSW4224086	0	9

This drawing is confidential and must not be reproduced or used without the consent of EXM

Ce dessin est confidentiel et ne doit pas être reproduit ou utilisé sans le consentement de EXM

NOTE	
ITEM	DESCRIPTION
1	NEMA 4X Enclosure
2	C/W Standard ground studs on box and cover
3	W/O Standard door stiffener
4	C/W Standard inner panel (Included)
5	C/W Standard inner panel mounting studs

No.	Revisions	Date	By/Par

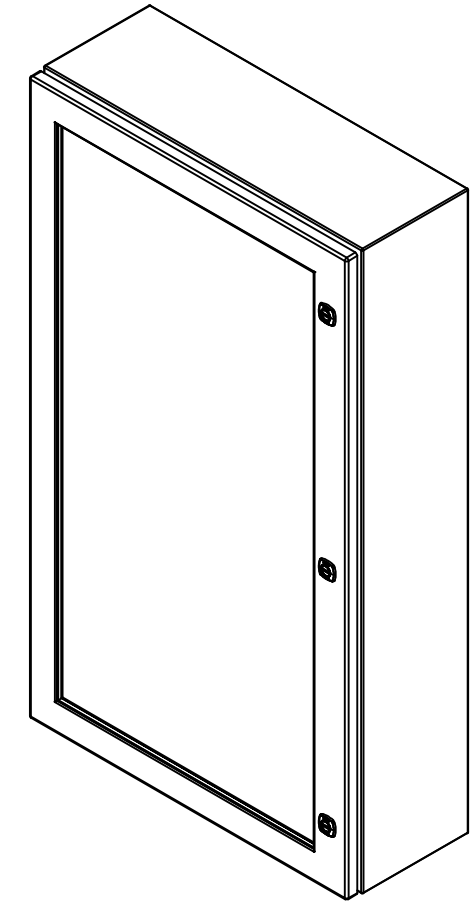

Isometric View



PACKING		
ITEM	QTY	DESCRIPTION
Cardboard sleeve	2	Top and Bottom
Cardboard strip	2	Between back of enclosure and inner panel
Plastic bag	1	To protect cover surface and inside gasket
Cardboard corner	4	To reinforced for the plastic strap tightening
Plastic strap - Black	2	To Squeeze the 2 cardboard sleeve together
Packaging label	3	White label with PN
Plastic strap- Green	2	To secure the enclosure to the wood pallet
Wood Pallet	1	2" deeper and 3" larger than enclosure size

1	881 SP4224G	0	881 SP - Inner Panel
3	STK-K-01320	0	5412 ES Inner Panel Accessory Kit
1	STK-K-01800	5	5412 ES Accessory Kit
1	5412ESSW4224086C	0	5412ESSW 42" x 24" Cover
1	5412ESSW4224086B	0	5412ESSW 42" x 24" x 8" Body
3	STK-Q-04051-08	1	M6 x 8mm Stainless Steel Hexagon Socket Head Machine Screw with Nyseal
Qty	Part Number	Rev	Description
Parts List			

<p>Tél: (450) 979-4373 Fax: (450) 979-4626 <a href="http://www.exmweb.com">www.exmweb.com</a></p>	Flatness Aplatissement	Max 3.0mm
	Projection	
Customer Client	Date	
Drawn By Dessiné Par	BoxCad: BoxCad	Date 22-Jun-23
Material Matière	16 Ga Stainless Steel 316 (1.4mm)	
Color Couleur	Unpainted	Finish Fini Brushed
Description	Detail Rev.	
5412ESSW 42" x 24" x 8" Assembly		
Part Number Numéro Pièce	Rev.	2
<b>5412ESSW4224086</b>	<b>0</b>	<b>9</b>

This drawing is confidential and must not be reproduced or used without the consent of EXM

Ce dessin est confidentiel et ne doit pas être reproduit ou utilisé sans le consentement de EXM

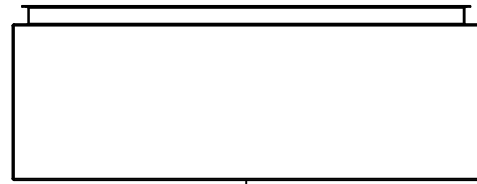

TOP

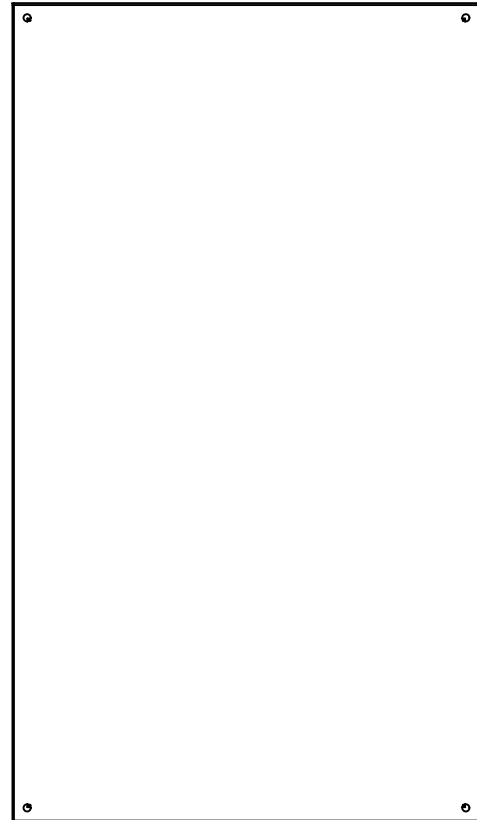

BACK

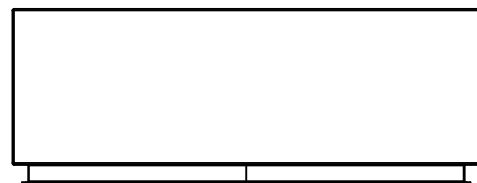

BOTTOM

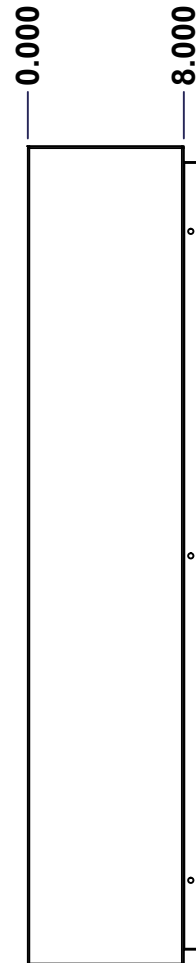

LEFT

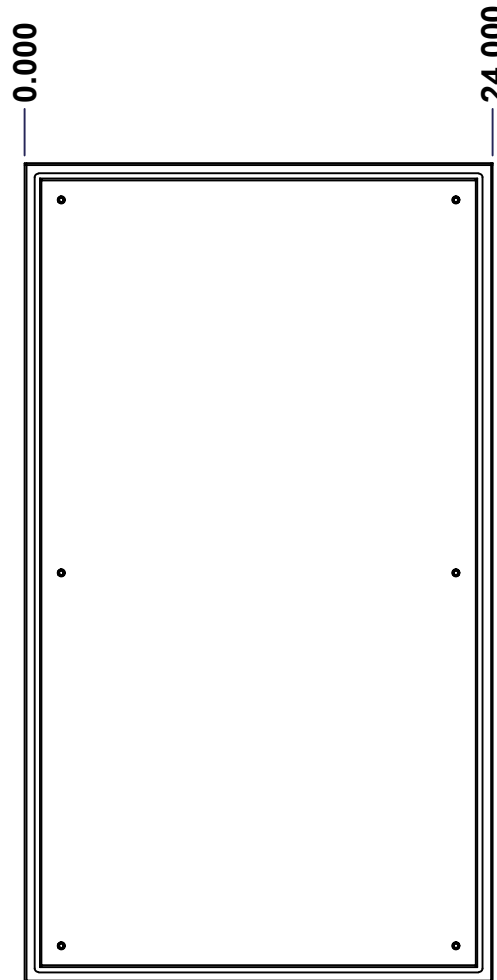

FRONT

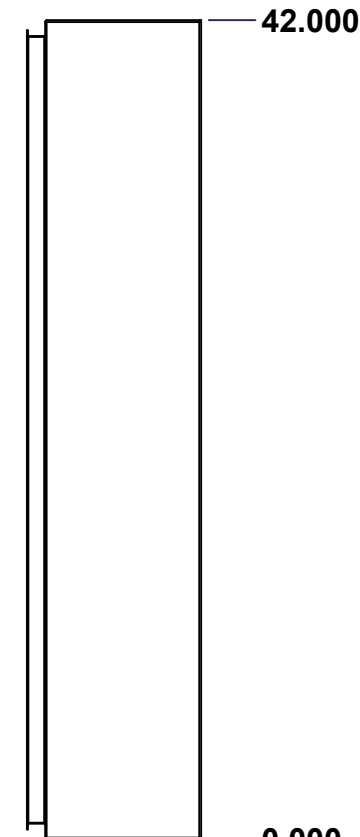

RIGHT

No.	Revisions	Date	By/Par

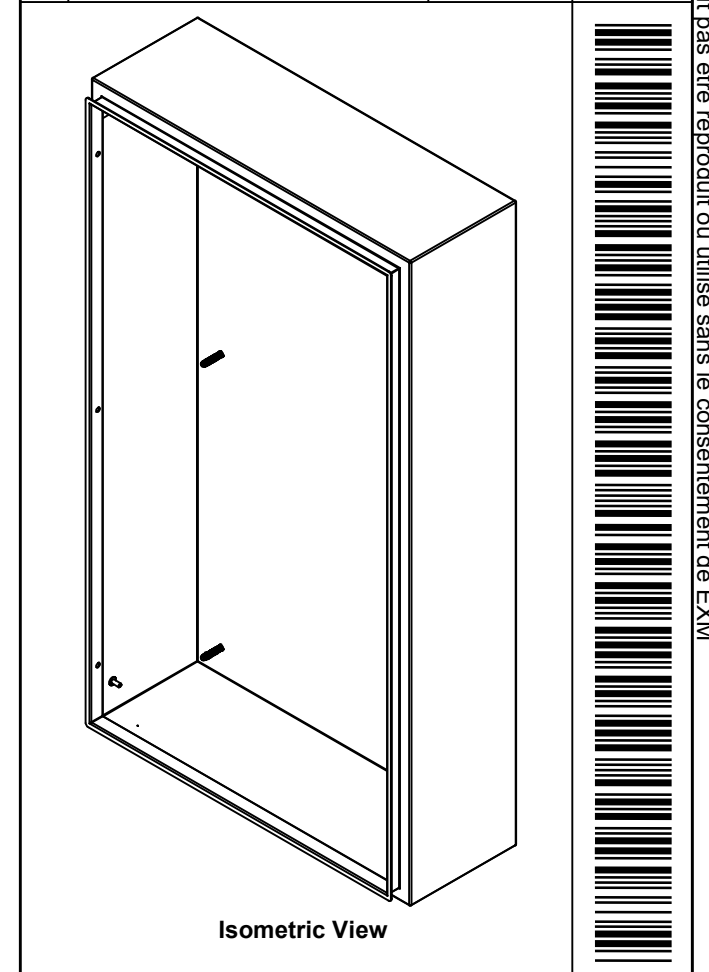

Isometric View

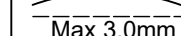
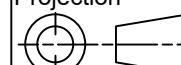
 Tél: (450) 979-4373 Fax: (450) 979-4626 <a href="http://www.exmweb.com">www.exmweb.com</a>		Flatness Aplatissement  Max 3.0mm Projection 	
Customer Client		Date	
Drawn By Dessiné Par BoxCad: BoxCad		Date 22-Jun-23	
Material Matière 16 Ga Stainless Steel 316 (1.4mm)			
Color Couleur Unpainted		Finish Fini Brushed	
Description 5412ESSW 42" x 24" x 8" Body			Detail Rev.
Part Number Numéro Pièce <b>5412ESSW4224086B</b>		Rev. <b>0</b>	3 9

SEE BILL OF MATERIAL ON LAST PAGE

This drawing is confidential and must not be reproduced or used without the consent of EXM

Ce dessin est confidentiel et ne doit pas être reproduit ou utilisé sans le consentement de EXM

STANDARD FEATURES ARE NOT LISTED IN THIS HOLE TABLE			
HOLE TABLE - LEFT VIEW (CUSTOM FEATURE ONLY)			
CUT-OUT	XDIM	YDIM	DESCRIPTION
1	6.000	40.000	LABEL_EXM (Inside)
2	6.500	2.000	GND STUD M6 x 16mm (Inside)

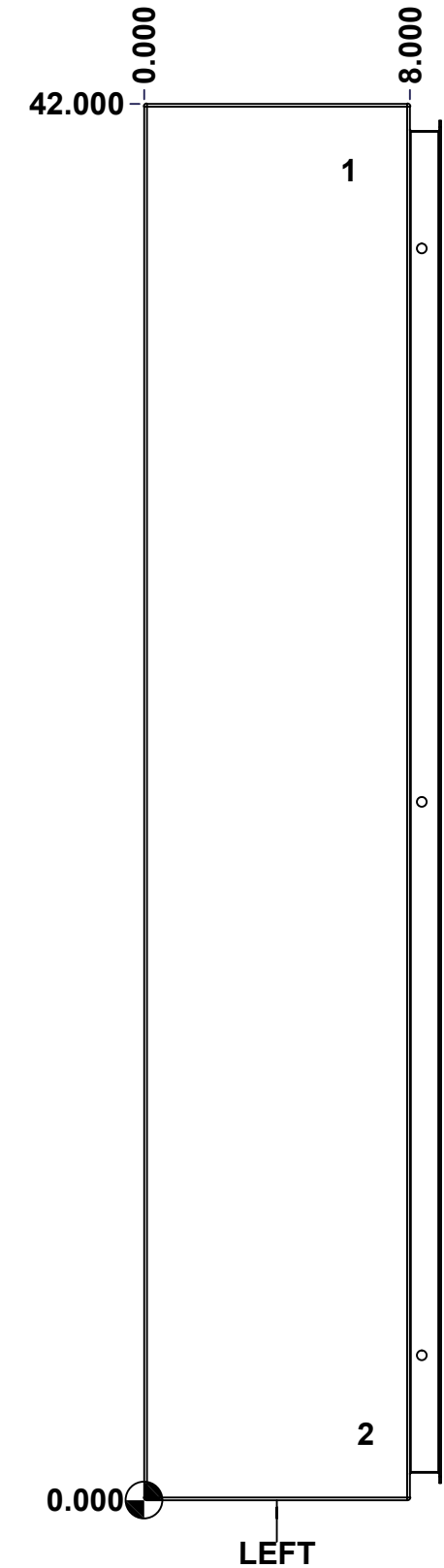

	Description	Status	
	5412ESSW 42" x 24" x 8" Body	(NULL)	
	Part Number Numéro Pièce	Rev.	
	<b>5412ESSW4224086B</b>	<b>0</b>	4 9

This drawing is confidential and must not be reproduced or used without the consent of EXM

Ce dessin est confidentiel et ne doit pas être reproduit ou utilisé sans le consentement de EXM

**STANDARD FEATURES ARE NOT LISTED IN THIS HOLE TABLE**

**HOLE TABLE - BACK VIEW (CUSTOM FEATURE ONLY)**

CUT-OUT	XDIM	YDIM	DESCRIPTION
1	1.875	1.875	IP STUD M8 x 35mm (Inside)
2	1.875	40.125	IP STUD M8 x 35mm (Inside)
3	22.125	40.125	IP STUD M8 x 35mm (Inside)
4	22.125	1.875	IP STUD M8 x 35mm (Inside)
5	1.875	21.000	IP STUD M8 x 35mm (Inside)
6	22.125	21.000	IP STUD M8 x 35mm (Inside)
-----			
7	23.250	0.750	RND Ø0.390
8	23.250	41.250	RND Ø0.390
9	0.750	41.250	RND Ø0.390
10	0.750	0.750	RND Ø0.390

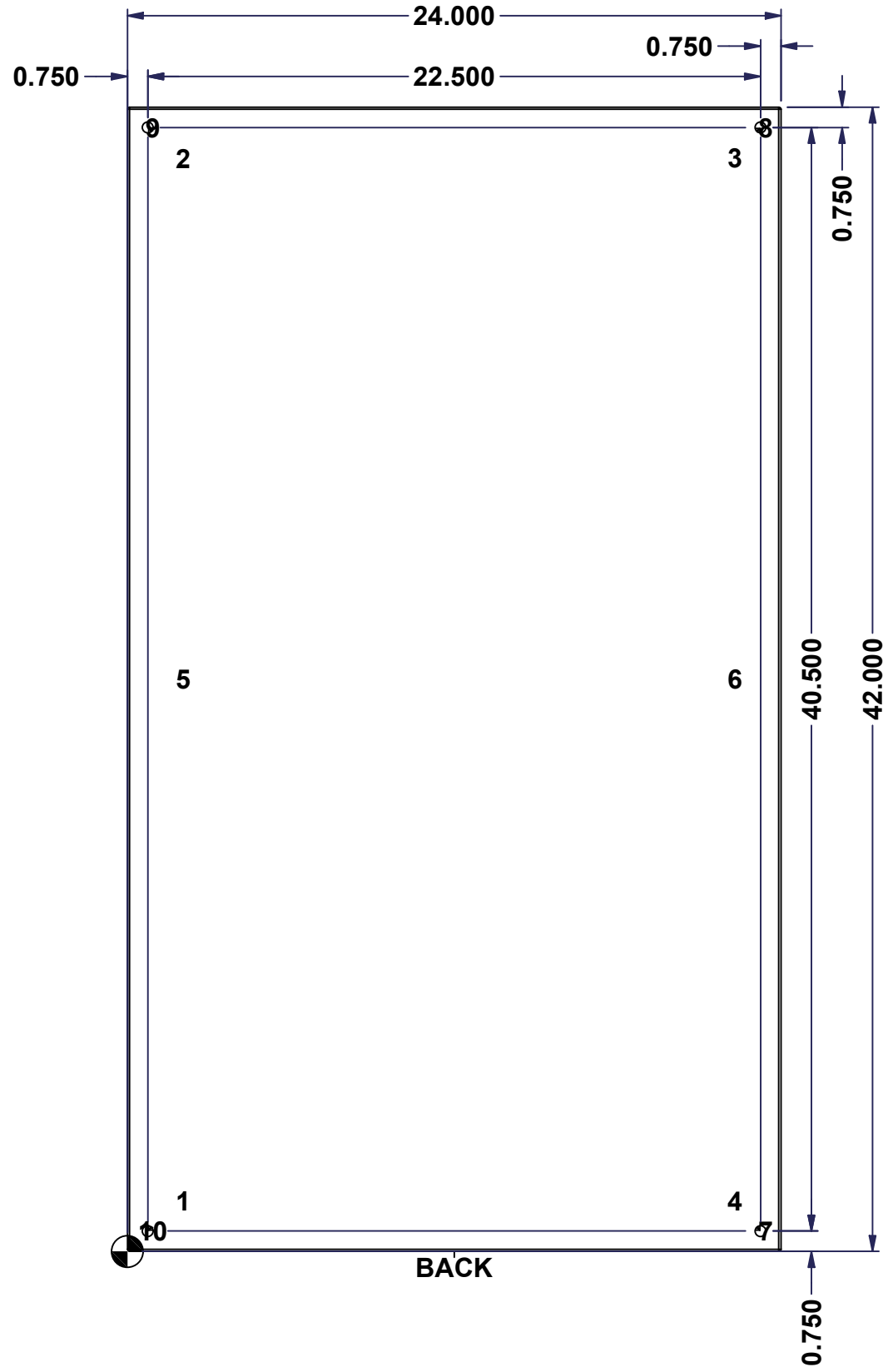

BACK

	Description	Status
	5412ESSW 42" x 24" x 8" Body	(NULL)
	Part Number	Rev.
	5412ESSW4224086B	5
		9

This drawing is confidential and must not be reproduced or used without the consent of EXM

Ce dessin est confidentiel et ne doit pas être reproduit ou utilisé sans le consentement de EXM

No.	Revisions	Date	By/Par

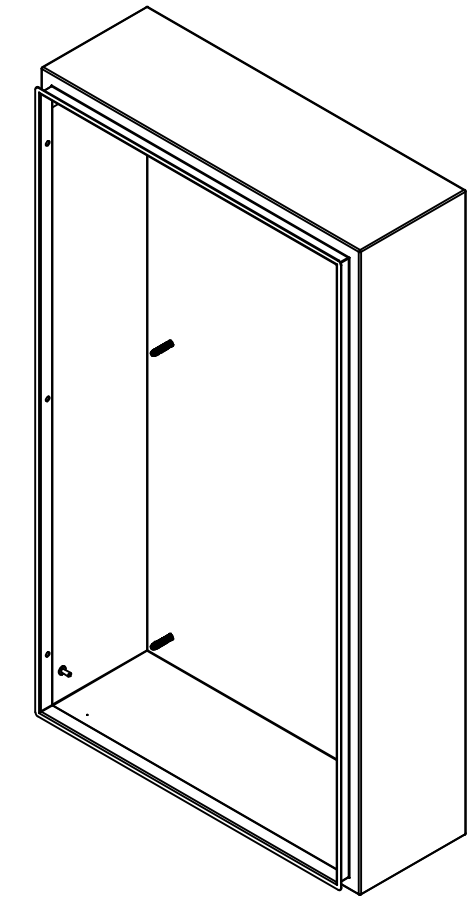

Isometric View

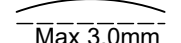
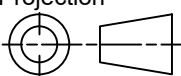

 Tél: (450) 979-4373 Fax: (450) 979-4626 <a href="http://www.exmweb.com">www.exmweb.com</a>		Flatness Aplatissement  Max 3.0mm Projection 
Customer Client	Date	
Drawn By Dessiné Par	BoxCad: BoxCad	Date 22-Jun-23
Material Matière	16 Ga Stainless Steel 316 (1.4mm)	
Color Couleur	Unpainted	Finish Fini Brushed
Description	Detail Rev.	
5412ESSW 42" x 24" x 8" Body		
Part Number Numéro Pièce	Rev.	6
<b>5412ESSW4224086B</b>	<b>0</b>	9

Qty	Part Number	Rev	Description
1	STK-Q-16085	0	Ground Stud M6 x 16mm Stainless Steel
1	STK-S-00100	0	3.5" x 2" Silver Milar Flexcon Sticker
6	STK-Q-16020	1	Stud M8 x 35mm Stainless Steel
1	5412ESSW4224086B-P	0	5412ESSW 42" x 24" x 8" Body Part
Parts List			

This drawing is confidential and must not be reproduced or used without the consent of EXM

Ce dessin est confidentiel et ne doit pas être reproduit ou utilisé sans le consentement de EXM

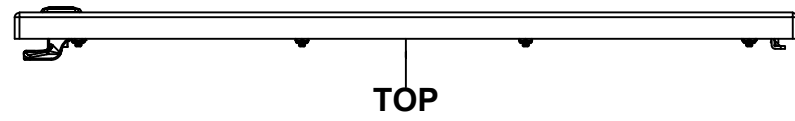

TOP

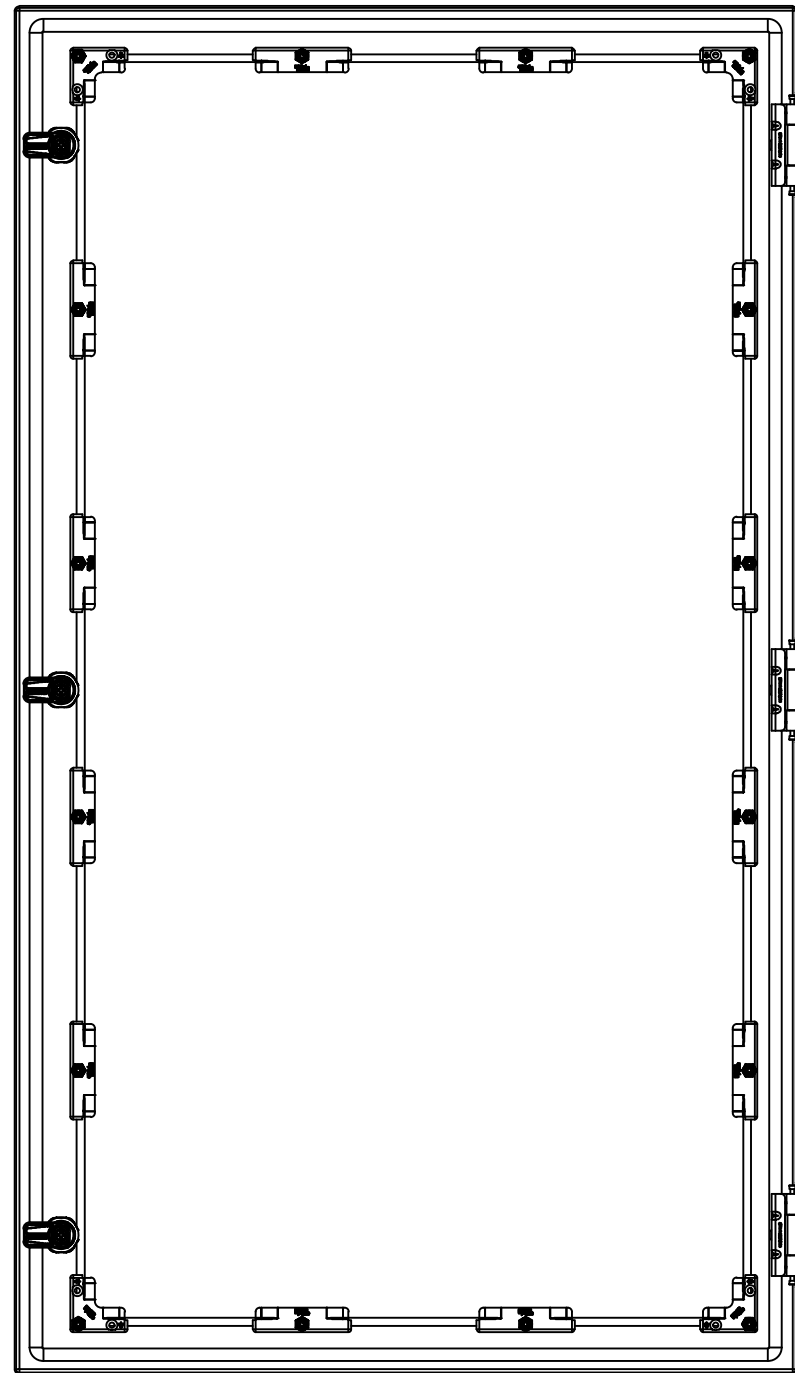

BACK

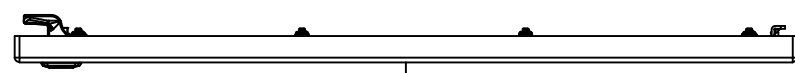

BOTTOM

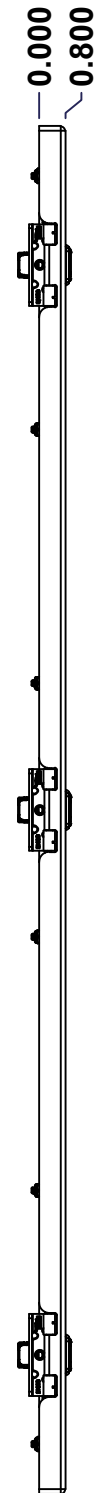

LEFT

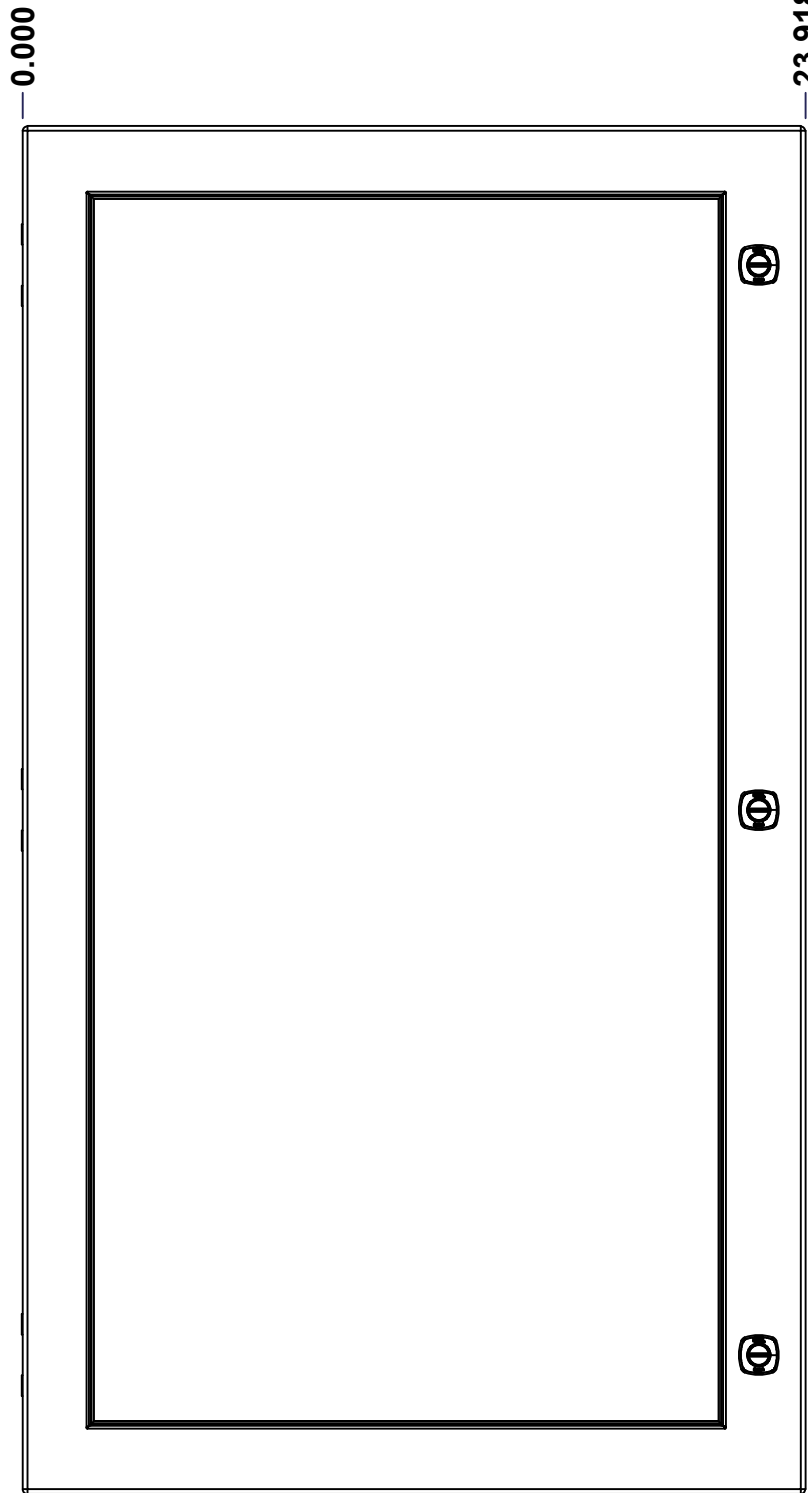

FRONT

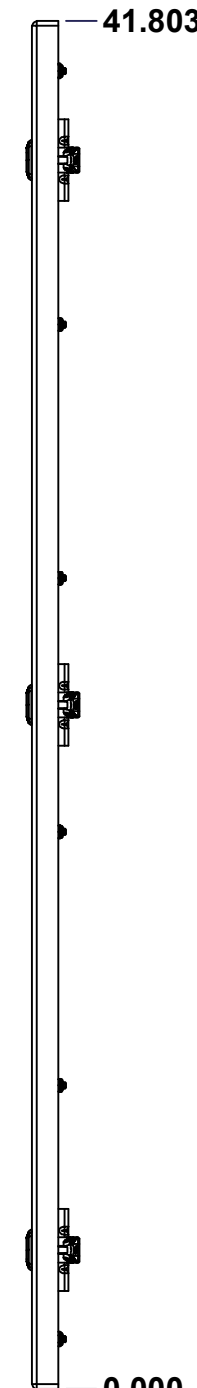

RIGHT

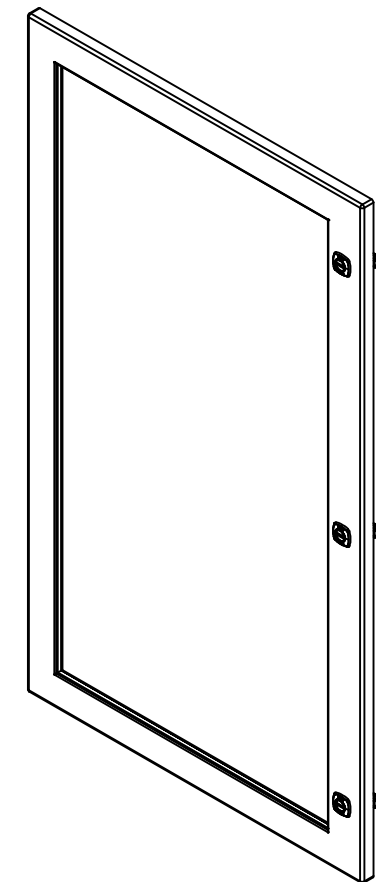

Isometric View

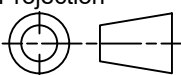

No.	Revisions	Date	By/Par

 Tél: (450) 979-4373 Fax: (450) 979-4626 <a href="http://www.exmweb.com">www.exmweb.com</a>		Flatness Aplatissement Max 3.0mm Projection 
Customer Client	Date	Date
Drawn By Dessiné Par	BoxCad: BoxCad	22-Jun-23
Material Matière 16 Ga Stainless Steel 316 (1.4mm)		
Color Couleur	Unpainted	Finish Fini Brushed
Description 5412ESSW 42" x 24" Cover		Detail Rev.
Part Number Numéro Pièce	Rev. 0	7/9

SEE BILL OF MATERIAL ON LAST PAGE

**5412ESSW4224086C**

This drawing is confidential and must not be reproduced or used without the consent of EXM

Ce dessin est confidentiel et ne doit pas être reproduit ou utilisé sans le consentement de EXM

STANDARD FEATURES ARE NOT LISTED IN THIS HOLE TABLE			
HOLE TABLE - FRONT VIEW (CUSTOM FEATURE ONLY)			
CUT-OUT	XDIM	YDIM	DESCRIPTION
1	1.469	9.277	STUD M6 x 18mm (Inside)
2	21.968	9.277	STUD M6 x 18mm (Inside)
3	1.469	17.027	STUD M6 x 18mm (Inside)
4	21.968	17.027	STUD M6 x 18mm (Inside)
5	1.469	24.776	STUD M6 x 18mm (Inside)
6	21.968	24.776	STUD M6 x 18mm (Inside)
7	1.469	32.526	STUD M6 x 18mm (Inside)
8	21.968	32.526	STUD M6 x 18mm (Inside)
9	1.469	40.276	STUD M6 x 18mm (Inside)
10	1.469	1.527	STUD M6 x 18mm (Inside)
11	8.302	40.276	STUD M6 x 18mm (Inside)
12	8.302	1.527	STUD M6 x 18mm (Inside)
13	15.135	40.276	STUD M6 x 18mm (Inside)
14	15.135	1.527	STUD M6 x 18mm (Inside)
15	21.968	40.276	STUD M6 x 18mm (Inside)
16	21.968	1.527	STUD M6 x 18mm (Inside)
-----			
17	22.494	37.553	880 SCQ4-SLSS6
18	22.494	20.902	880 SCQ4-SLSS6
19	22.494	4.250	880 SCQ4-SLSS6

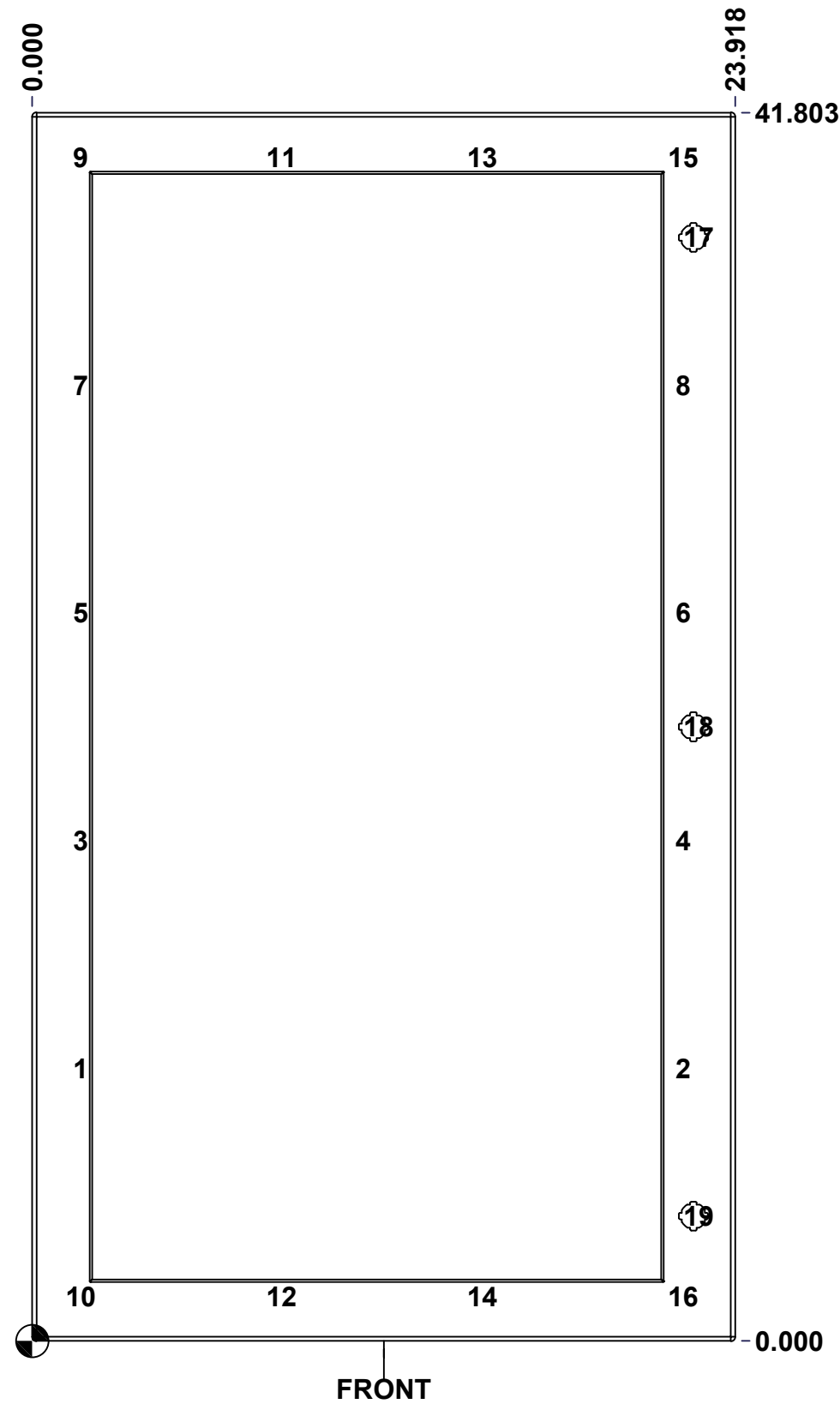

	Description	Status
	5412ESSW 42" x 24" Cover	(NULL)
	Part Number	Rev.
	Numéro Pièce	8
	<b>5412ESSW4224086C</b>	<b>0</b>
		9



This drawing is confidential and must not be reproduced or used without the consent of EXM

Ce dessin est confidentiel et ne doit pas être reproduit ou utilisé sans le consentement de EXM

No.	Revisions	Date	By/Par

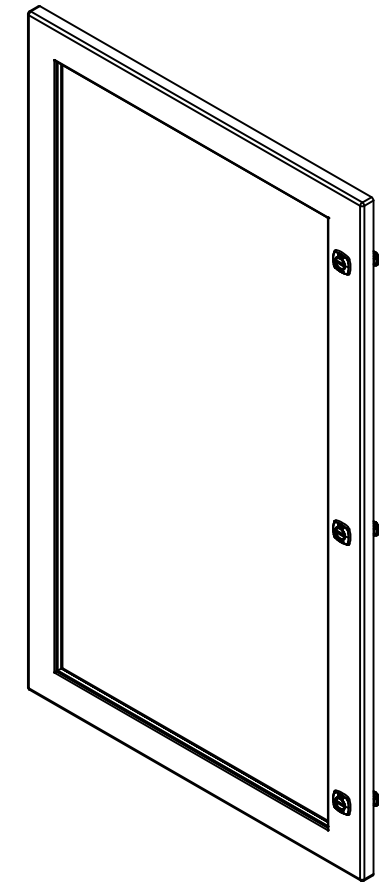

Isometric View

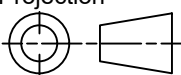

12	STK-Q-60701	2.1	880 WK - Lexan 1/4" Fixing Bracket
1	STK-A-60703	0	5412 ESW Lexan Bracket Kit
16	STK-Q-16053	1	Stud M6 x 23mm Stainless steel
1	STK-G-02710	0	880 HWKG - Windows Kit Gasket
1	5412ESSW4224086LXG	0	5412ESSW 42" x 24" Lexan Gasket Part
1	5412ESSW4224086LX	0	5412ESSW 38.375" x 20.125" Lexan Part
1	5412ESSW4224086G	0	5412ESSW 42" x 24" Cover Gasket Part
1	5412ESSW4224086C-P	0	5412ESSW 42" x 24" Cover Part
3	880 SCQ4-SLSS6	7	5412 ESS 1/4 Turn Lock
3	STK-A-33016	0	5412 ESS Bended Hinge (Body Part)
QTY	Part Number	Rev	Description
Parts List			

 Tél: (450) 979-4373 Fax: (450) 979-4626 <a href="http://www.exmweb.com">www.exmweb.com</a>	Flatness Aplatissement	Max 3.0mm
	Projection	
Customer Client	Date	
Drawn By Dessiné Par	BoxCad: BoxCad	Date 22-Jun-23
Material Matière	16 Ga Stainless Steel 316 (1.4mm)	
Color Couleur	Unpainted	Finish Fini Brushed
Description	Detail Rev.	
5412ESSW 42" x 24" Cover		
Part Number Numéro Pièce	Rev.	9
<b>5412ESSW4224086C</b>	<b>0</b>	<b>9</b>

This drawing is confidential and must not be reproduced or used without the consent of EXM

Ce dessin est confidentiel et ne doit pas être reproduit ou utilisé sans le consentement de EXM

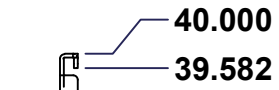
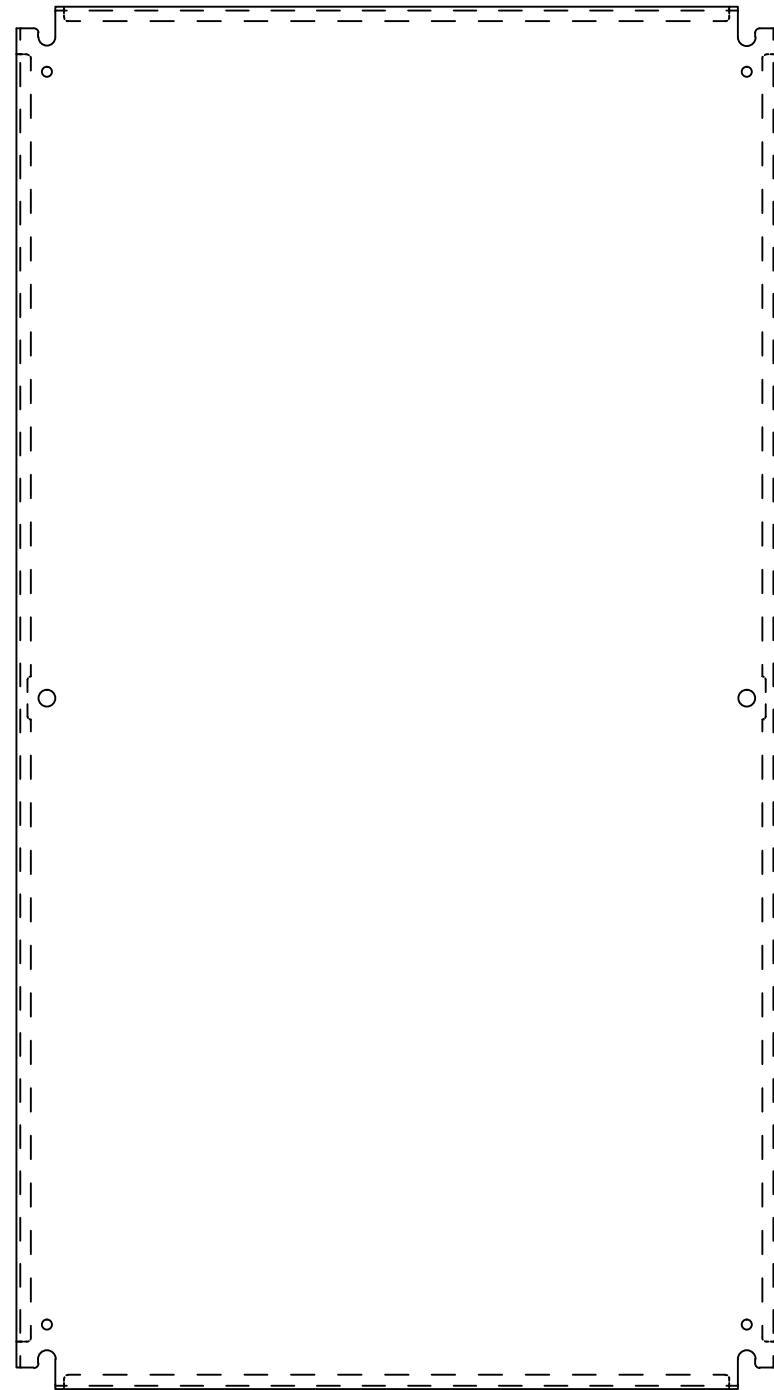
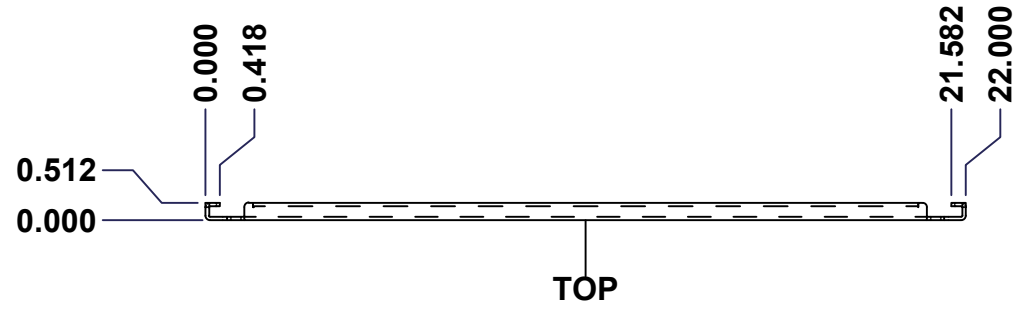

No.	Revisions	Date	By/Par

Isometric View

**EXM**  
exm

Tél: (450) 979-4373  
Fax: (450) 979-4626  
www.exmweb.com

Flatness  
Aplatissement  
Max 3.0mm

Projection

Customer Client	Date
Drawn By Dessiné Par BoxCad	Date 23-Jan-07
Material Matière	See Part List
Color Couleur	See Part List
Finish Fini	See Part List

Description	881 SP - Inner Panel	Detail Rev.
Part Number Numéro Pièce	<b>881 SP4224G</b>	Rev. 0

Qty	Part Number	Rev	Description	Material	Color	Finish
1	881 SP4224G-P	0	881 SP - Inner Panel Part	12 Ga Galvanized	Unpainted	Galvanized

Parts List

This drawing is confidential and must not be reproduced or used without the consent of EXM

Ce dessin est confidentiel et ne doit pas être reproduit ou utilisé sans le consentement de EXM

Table 1			FRONT VIEW
CUT-OUT	XDIM	YDIM	DESCRIPTION
1	0.875	1.875	GROUND HOLE (RND Ø0.290)
2	21.125	1.875	GROUND HOLE (RND Ø0.290)
3	0.875	38.125	GROUND HOLE (RND Ø0.290)
4	21.125	38.125	GROUND HOLE (RND Ø0.290)
5	0.875	20.000	MTG STUD HOLE (RND Ø0.500)
6	21.125	20.000	MTG STUD HOLE (RND Ø0.500)

All knockouts are actual size / Les disques défonçables sont grandeur réel

No.	Revisions	Date	By/Par

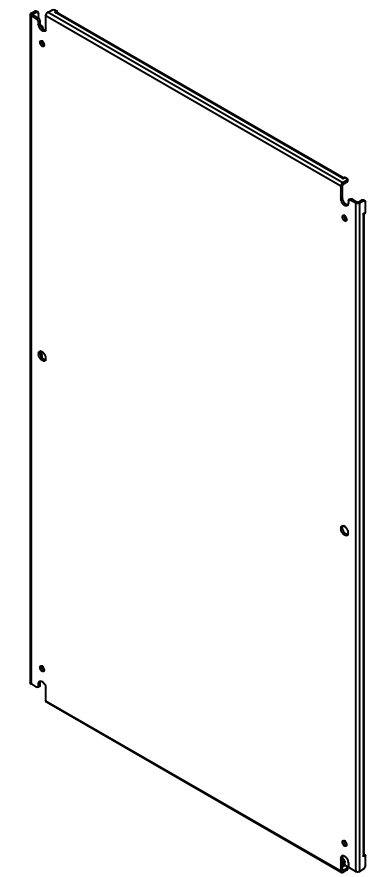
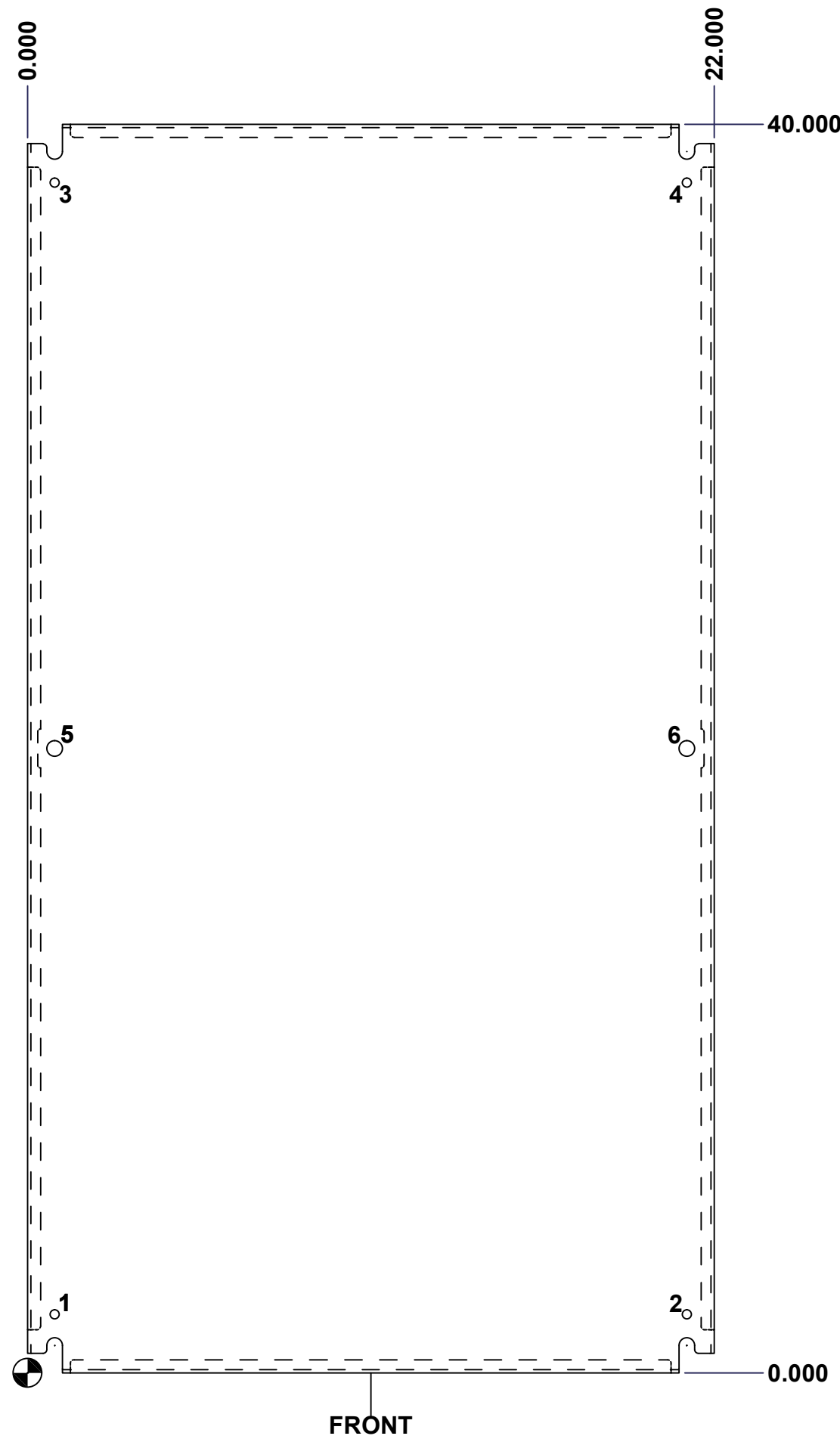

Isometric View



	Tél: (450) 979-4373 Fax: (450) 979-4626 www.exmweb.com	Flatness Aplatissement
		Max 3.0mm
Projection		
Customer Client		Date
Drawn By Dessiné Par	BoxCad	Date 23-Jan-07
Material Matière	See Part List	
Color Couleur	See Part List	Finish Fini See Part List
Description	Detail Rev.	
881 SP - Inner Panel		
Part Number Numéro Pièce	Rev.	2
881 SP4224G	0	2