

This drawing is confidential and must not be reproduced or used without the consent of EXM

Ce dessin est confidentiel et ne doit pas être reproduit ou utilisé sans le consentement de EXM

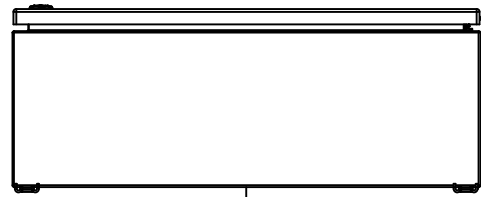

TOP

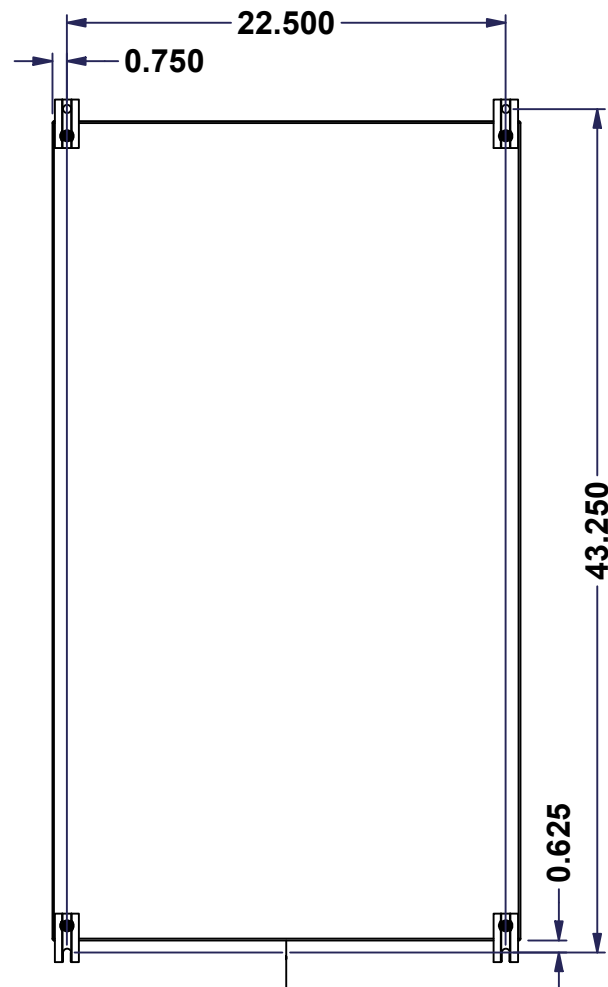

BACK

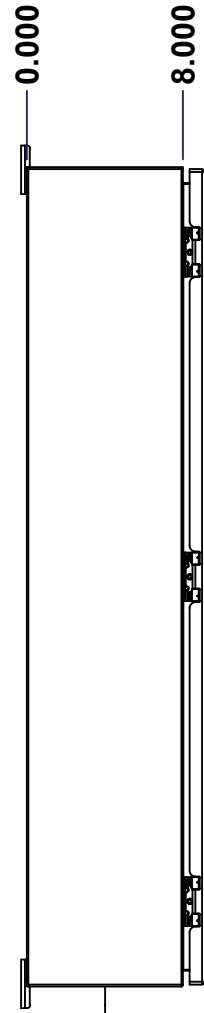

LEFT

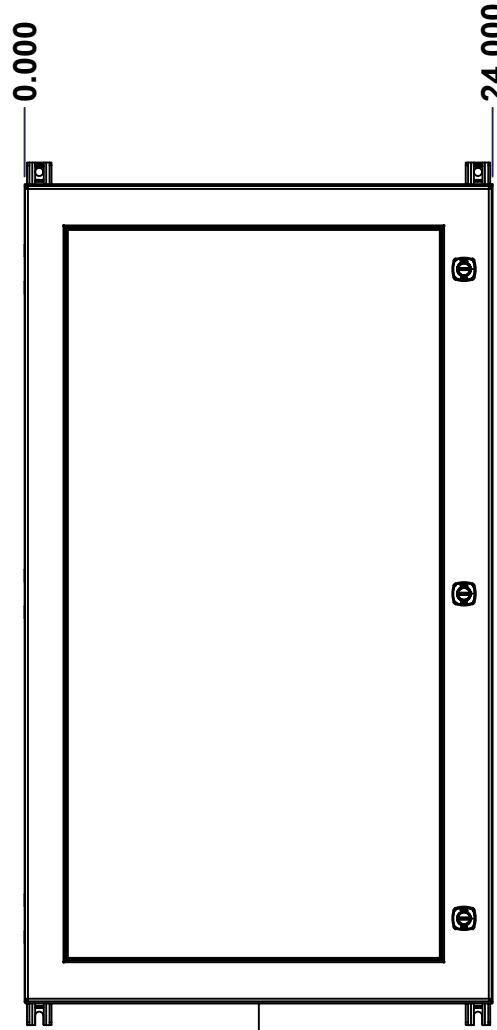

FRONT

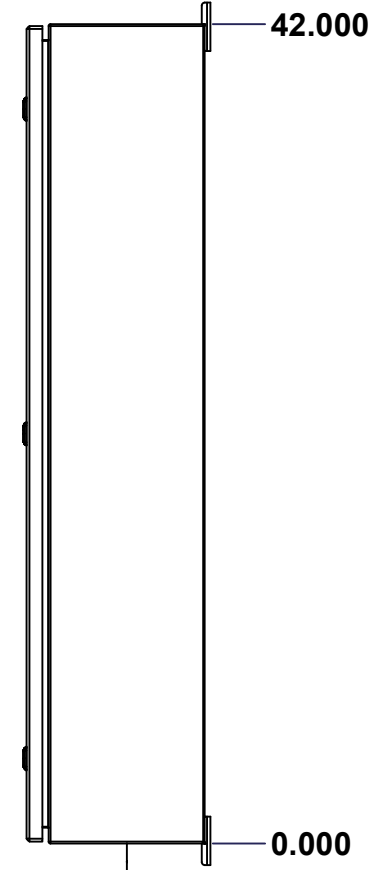

RIGHT

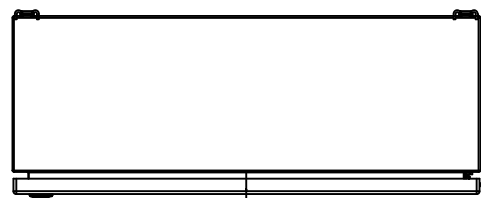

BOTTOM

**GRAIN DIRECTION:
TOP/BOTTOM: HORIZONTAL
LEFT/RIGHT/BACK/FRONT: VERTICAL**

SEE BILL OF MATERIAL ON LAST PAGE

No.	Revisions	Date	By/Par

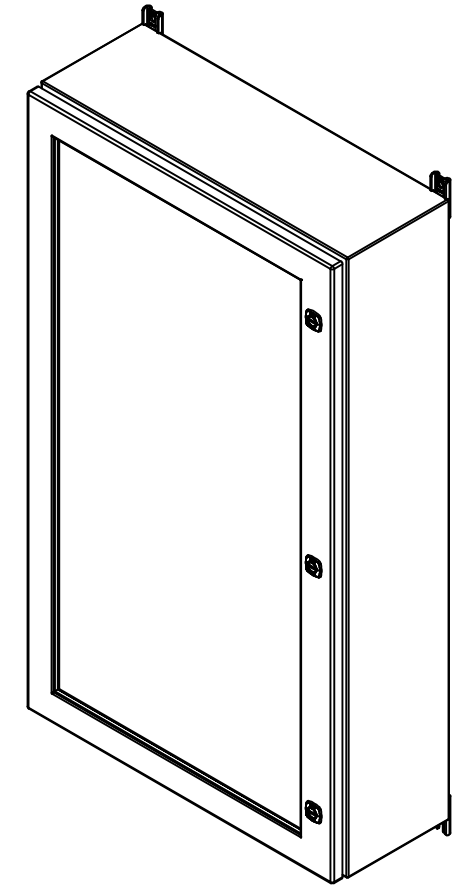

Isometric View



	Flatness Aplatissement Max 3.0mm	
	Projection 	
Customer Client	Date	
Drawn By Dessiné Par	BoxCad: BoxCad	Date 07-Jun-23
Material Matière	16 Ga Stainless Steel 304 (1.4mm)	
Color Couleur	Unpainted	Finish Fini Brushed
Description	Detail Rev.	
5412ESSW 42" x 24" x 8" Assembly		
Part Number Numéro Pièce	Rev. 0	1 / 15
5412ESSW422408TH		

This drawing is confidential and must not be reproduced or used without the consent of EXM

Ce dessin est confidentiel et ne doit pas être reproduit ou utilisé sans le consentement de EXM

NOTE	
ITEM	DESCRIPTION
1	NEMA 4X Enclosure
2	C/W Standard ground studs on box and cover
3	W/O Standard door stiffener
4	C/W Standard inner panel (Included)
5	C/W Standard inner panel mounting studs
6	C/W 885 ESMF4_OPEN Sold separately (Installed)
7	C/W 885 ESMF4_CLOSE Sold separately (Installed)
8	C/W R5 Insulation (Installed by EXM)

No.	Revisions	Date	By/Par

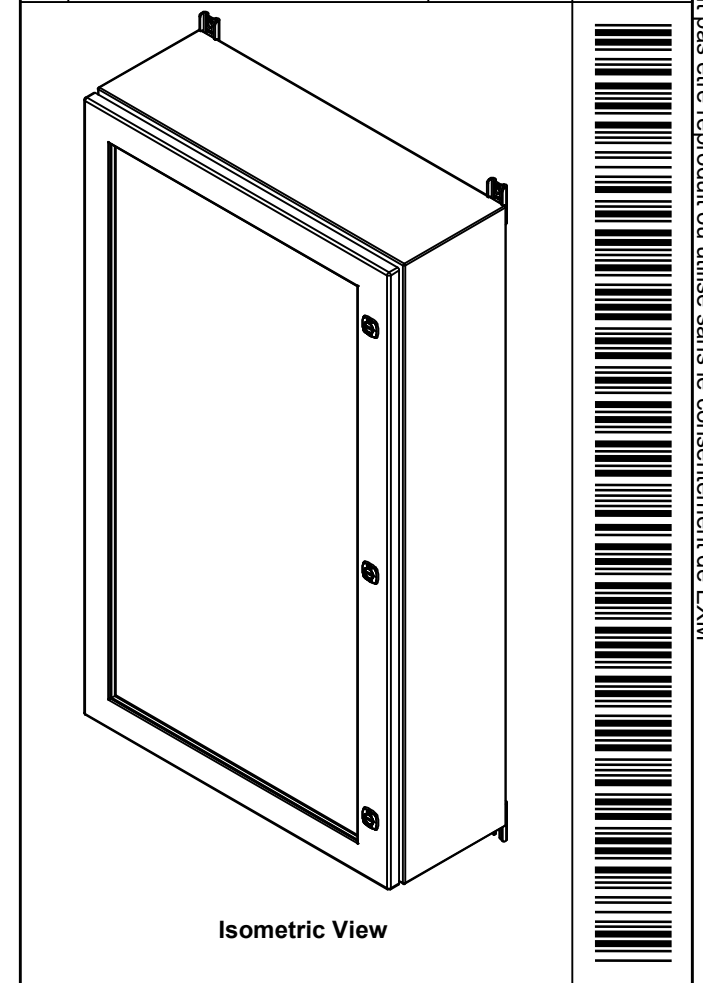

PACKING		
ITEM	QTY	DESCRIPTION
Cardboard sleeve	2	Top and Bottom
Cardboard strip	2	Between back of enclosure and inner panel
Plastic bag	1	To protect cover surface and inside gasket
Cardboard corner	4	To reinforced for the plastic strap tightening
Plastic strap - Black	2	To Squeeze the 2 cardboard sleeve together
Packaging label	3	White label with PN
Plastic strap- Green	2	To secure the enclosure to the wood pallet
Wood Pallet	1	2" deeper and 3" larger than enclosure size

6	STK-Q-00600	2	M12 to M8 Adaptor
1	881 SP4224G	0	881 SP - Inner Panel
1	STK-K-01800	5	5412 ES Accessory Kit
1	5412ESSW422408THC	0	5412ESSW 42" x 24" Cover
1	5412ESSW422408THB	0	5412ESSW 42" x 24" x 8" Body
3	STK-Q-04051-08	1	M6 x 8mm Stainless Steel Hexagon Socket Head Machine Screw with Nyseal
Qty	Part Number	Rev	Description
Parts List			

<p>Tél: (450) 979-4373 Fax: (450) 979-4626 www.exmweb.com</p>	Flatness Aplatissement	Max 3.0mm
	Projection	
Customer Client	Date	
Drawn By Dessiné Par	BoxCad: BoxCad	Date 07-Jun-23
Material Matière	16 Ga Stainless Steel 304 (1.4mm)	
Color Couleur	Unpainted	Finish Fini Brushed
Description	Detail Rev.	
5412ESSW 42" x 24" x 8" Assembly		
Part Number Numéro Pièce	Rev.	2
5412ESSW422408TH	0	15

This drawing is confidential and must not be reproduced or used without the consent of EXM

Ce dessin est confidentiel et ne doit pas être reproduit ou utilisé sans le consentement de EXM

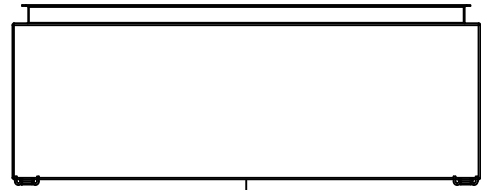

TOP

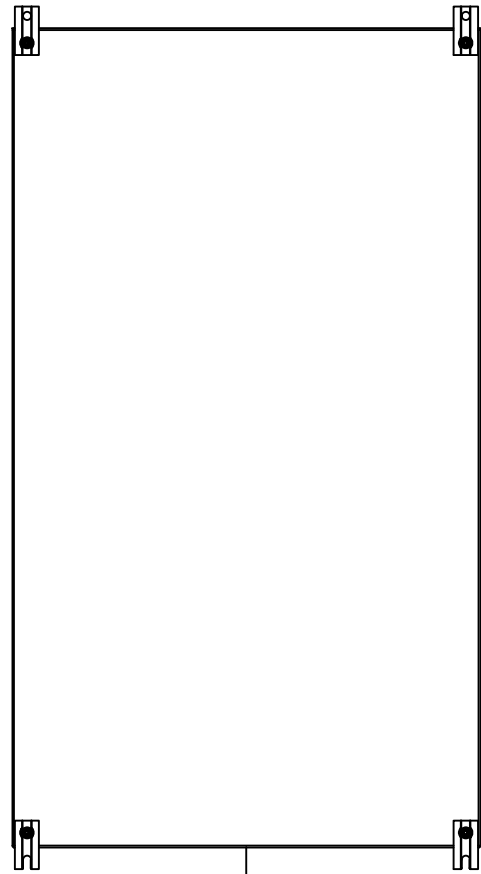

BACK

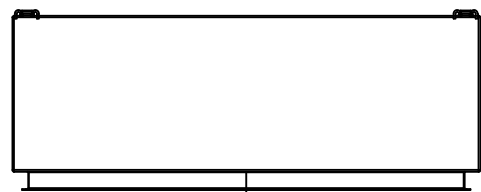

BOTTOM

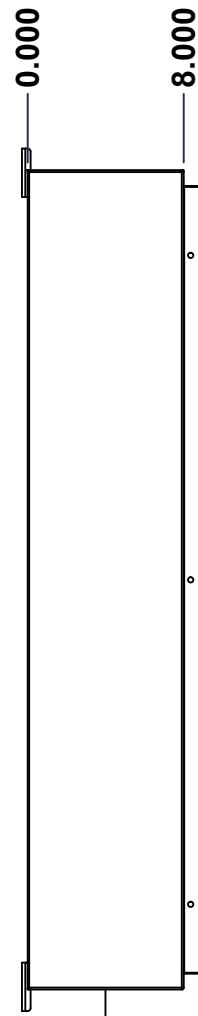

LEFT

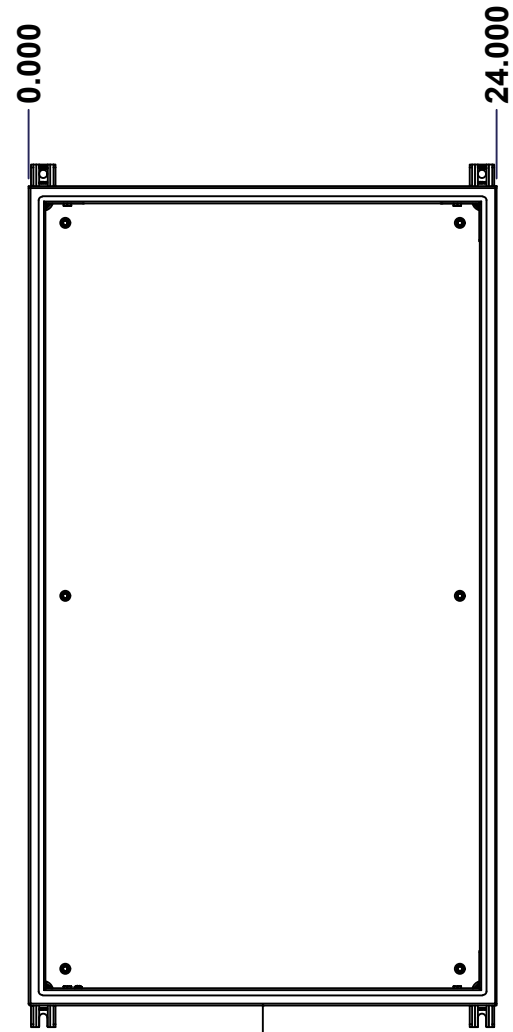

FRONT

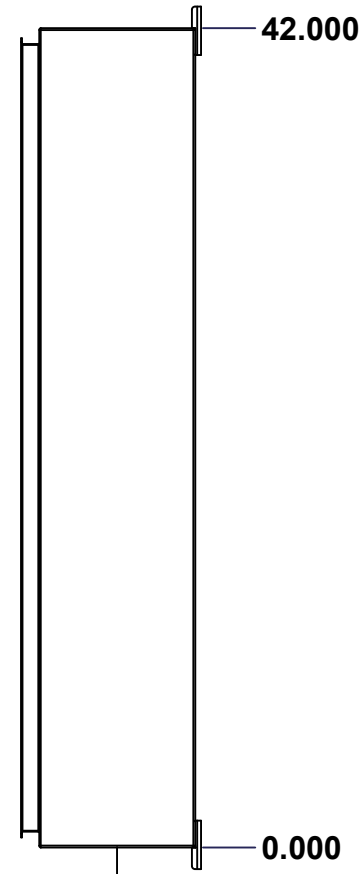

RIGHT

No.	Revisions	Date	By/Par

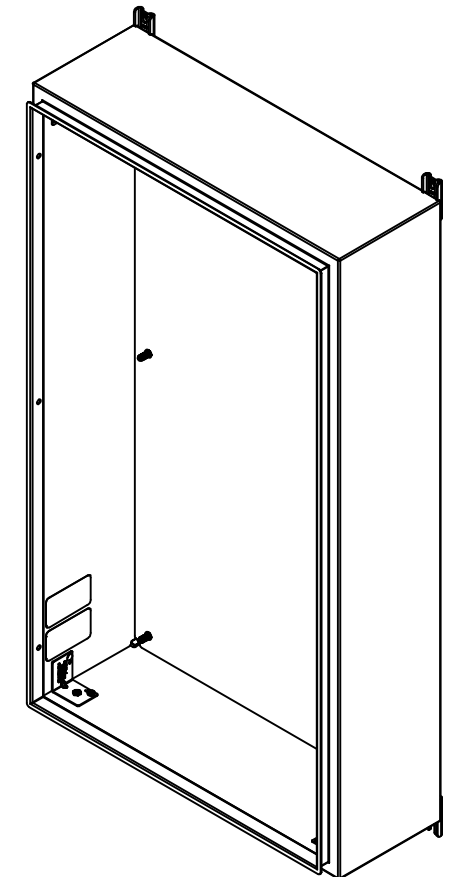

Isometric View



Tél: (450) 979-4373
 Fax: (450) 979-4626
www.exmweb.com

Flatness
Aplatissement
Max 3.0mm
Projection

Customer Client	Date
Drawn By Dessiné Par BoxCad: BoxCad	Date 07-Jun-23
Material Matière 16 Ga Stainless Steel 304 (1.4mm)	
Color Couleur Unpainted	Finish Fini Brushed
Description 5412ESSW 42" x 24" x 8" Body	Detail Rev.
Part Number Numéro Pièce 5412ESSW422408THB	Rev. 3
	0

SEE BILL OF MATERIAL ON LAST PAGE

This drawing is confidential and must not be reproduced or used without the consent of EXM

Ce dessin est confidentiel et ne doit pas être reproduit ou utilisé sans le consentement de EXM

STANDARD FEATURES ARE NOT LISTED IN THIS HOLE TABLE			
HOLE TABLE - TOP VIEW (CUSTOM FEATURE ONLY)			
CUT-OUT	XDIM	YDIM	DESCRIPTION
1	2.000	6.500	INSUL. STUD M6 x 18mm (Inside)
2	22.000	6.500	INSUL. STUD M6 x 18mm (Inside)

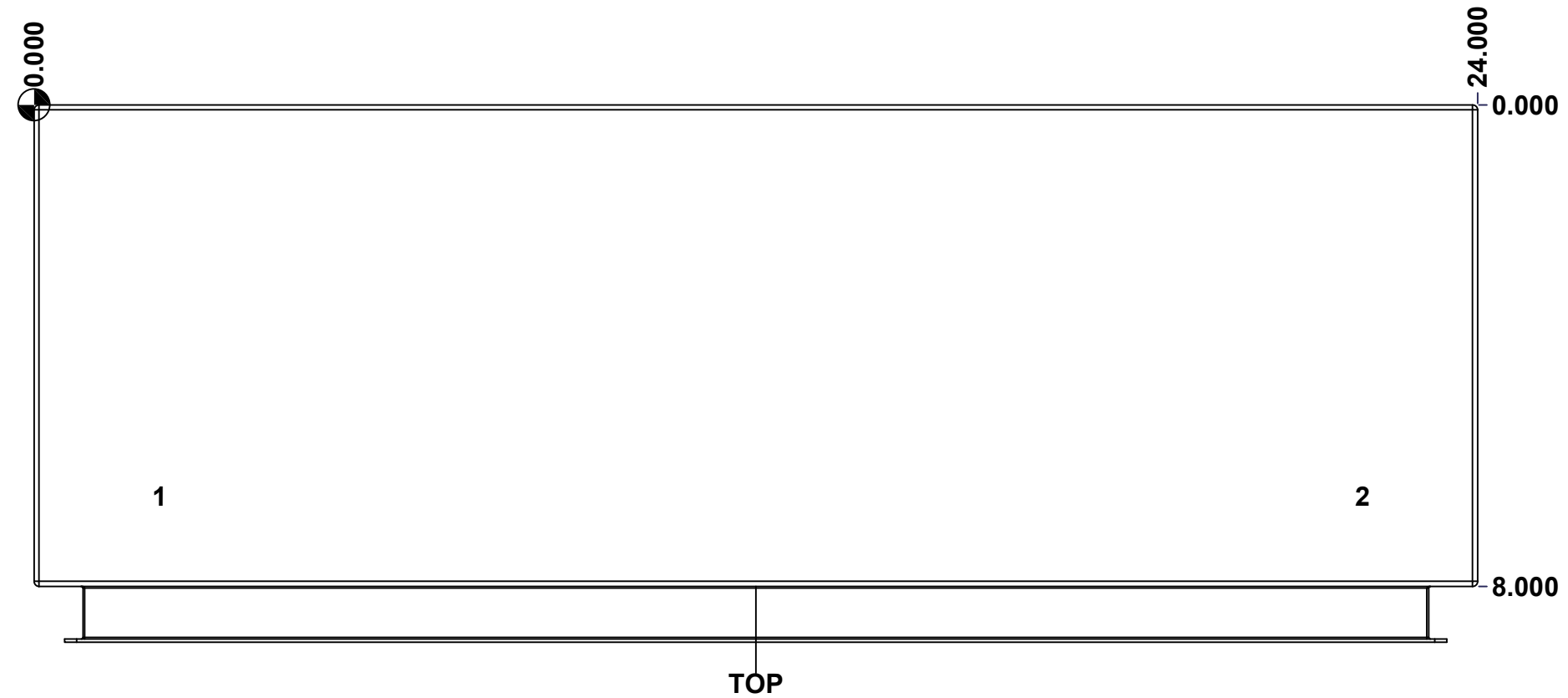

	Description	Status
	5412ESSW 42" x 24" x 8" Body	(NULL)
	Part Number Numéro Pièce	Rev.
	5412ESSW422408THB	0
		4
		15

This drawing is confidential and must not be reproduced or used without the consent of EXM

Ce dessin est confidentiel et ne doit pas être reproduit ou utilisé sans le consentement de EXM

STANDARD FEATURES ARE NOT LISTED IN THIS HOLE TABLE			
HOLE TABLE - BOTTOM VIEW (CUSTOM FEATURE ONLY)			
CUT-OUT	XDIM	YDIM	DESCRIPTION
1	2.000	6.500	INSUL. STUD M6 x 18mm (Inside)
2	22.000	6.500	INSUL. STUD M6 x 18mm (Inside)



	Description	Status	
	5412ESSW 42" x 24" x 8" Body	(NULL)	
	Part Number Numéro Pièce	Rev.	
	5412ESSW422408THB	0	5 15

This drawing is confidential and must not be reproduced or used without the consent of EXM

Ce dessin est confidentiel et ne doit pas être reproduit ou utilisé sans le consentement de EXM

STANDARD FEATURES ARE NOT LISTED IN THIS HOLE TABLE

HOLE TABLE - BACK VIEW (CUSTOM FEATURE ONLY)

CUT-OUT	XDIM	YDIM	DESCRIPTION
1	1.875	1.875	IP STUD M8 x 35mm (Inside)
2	1.875	40.125	IP STUD M8 x 35mm (Inside)
3	22.125	40.125	IP STUD M8 x 35mm (Inside)
4	22.125	1.875	IP STUD M8 x 35mm (Inside)
5	1.875	21.000	IP STUD M8 x 35mm (Inside)
6	22.125	21.000	IP STUD M8 x 35mm (Inside)

7	23.250	0.000	FOOT 885 ESMF4_OPEN
8	0.750	0.000	FOOT 885 ESMF4_OPEN
9	23.250	42.000	FOOT 885 ESMF4_CLOSE
10	0.750	42.000	FOOT 885 ESMF4_CLOSE

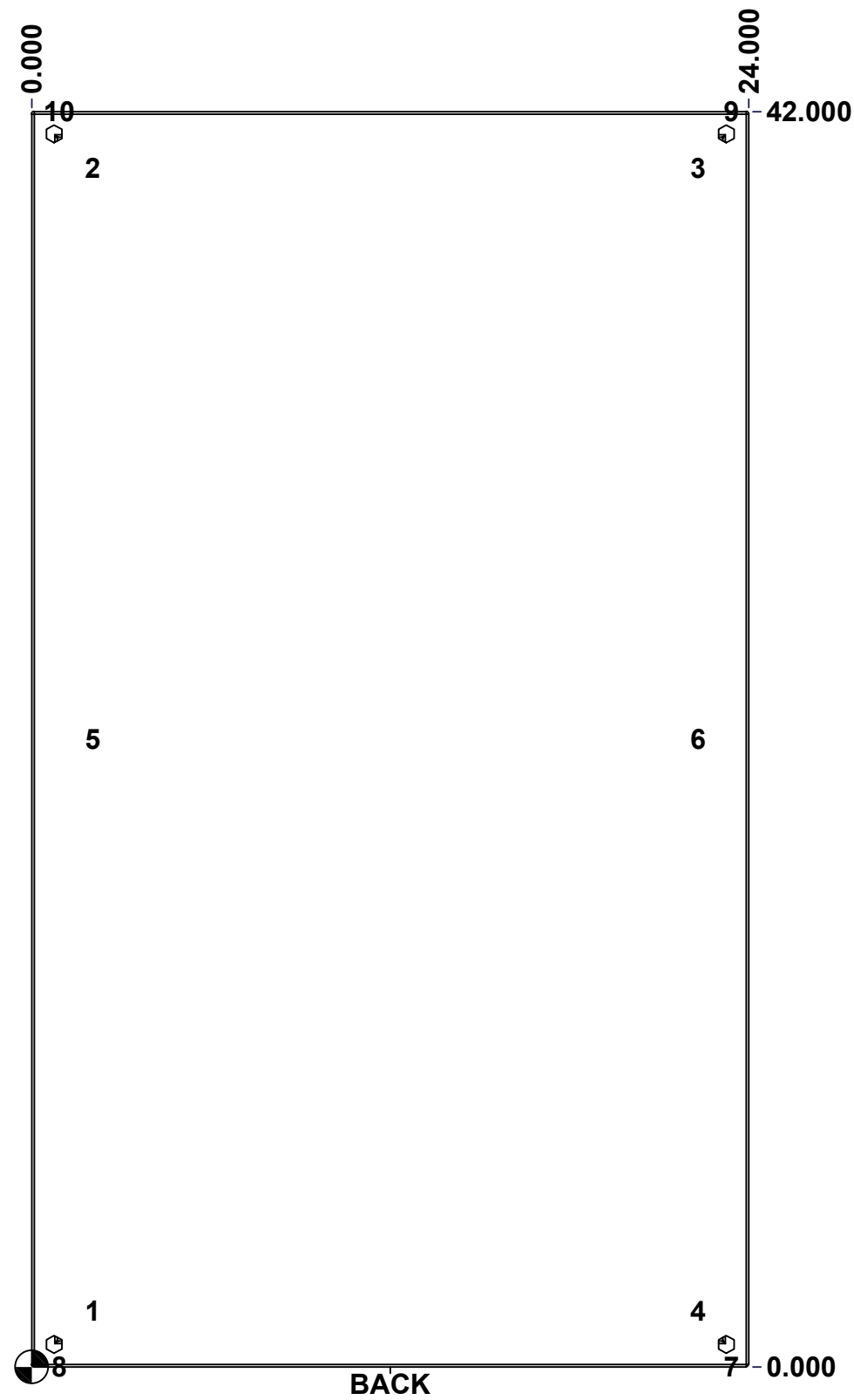

	Description	Status
	5412ESSW 42" x 24" x 8" Body	(NULL)
	Part Number Numéro Pièce	Rev.
	5412ESSW422408THB	0 / 6
		15

This drawing is confidential and must not be reproduced or used without the consent of EXM

Ce dessin est confidentiel et ne doit pas être reproduit ou utilisé sans le consentement de EXM

No.	Revisions	Date	By/Par

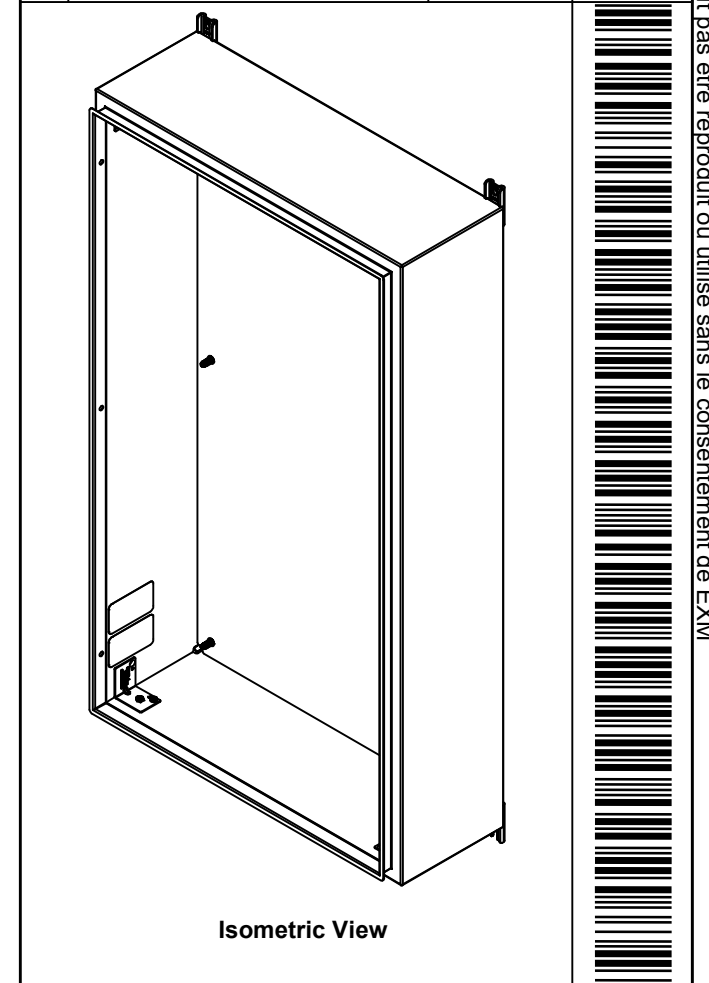

2	885ESMF4-FEET	0	885 ESMF4 Stainless Steel Mounting Foot
4	RIVET_NUT_SS_M10_FH_CE	0	Stainless Steel Rivet Nut M10 (Low Profile Close End)
4	STK-Q-06670	2	M10 x 16mm Stainless Steel Machine Screw
2	885ESMF4-FEET-A	0	885 ESMF4 Stainless Steel Mounting Foot (Opened Slot)
2	STK-S-00100	0	3.5" x 2" Silver Milar Flexcon Sticker
1	STK-K-70554	3	5412 ESTH Accessory Kit
1	5412ESSW422408THI-RS	0	5412ESSW 42" x 24" Right Insulation
1	5412ESSW422408THI-LS	0	5412ESSW 42" x 24" Left Insulation
1	5412ESSW422408THI-BT	0	5412ESSW 42" x 24" Top and Bottom Insulation
1	5412ESSW422408THI-TP	0	5412ESSW 42" x 24" Top and Bottom Insulation
1	5412ESSW422408THI-B	0	5412ESSW 42" x 24" Back Insulation
4	STK-Q-16070	1	Stud M6 x 18mm Stainless steel
6	STK-Q-16020	1	Stud M8 x 35mm Stainless Steel
1	5412ESSW422408THB-P	0	5412ESSW 42" x 24" x 8" Body Part

Qty	Part Number	Rev	Description
Parts List			

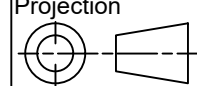
 Tél: (450) 979-4373 Fax: (450) 979-4626 www.exmweb.com	Flatness Aplatissement	Max 3.0mm
	Projection	
Customer Client	Date	
Drawn By Dessiné Par	BoxCad: BoxCad	Date 07-Jun-23
Material Matière	16 Ga Stainless Steel 304 (1.4mm)	
Color Couleur	Unpainted	Finish Fini Brushed
Description	Detail Rev.	
5412ESSW 42" x 24" x 8" Body		
Part Number Numéro Pièce	Rev.	7
5412ESSW422408THB	0	15

This drawing is confidential and must not be reproduced or used without the consent of EXM

Ce dessin est confidentiel et ne doit pas être reproduit ou utilisé sans le consentement de EXM

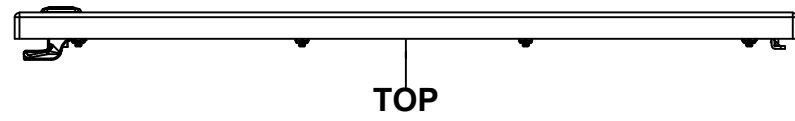

TOP

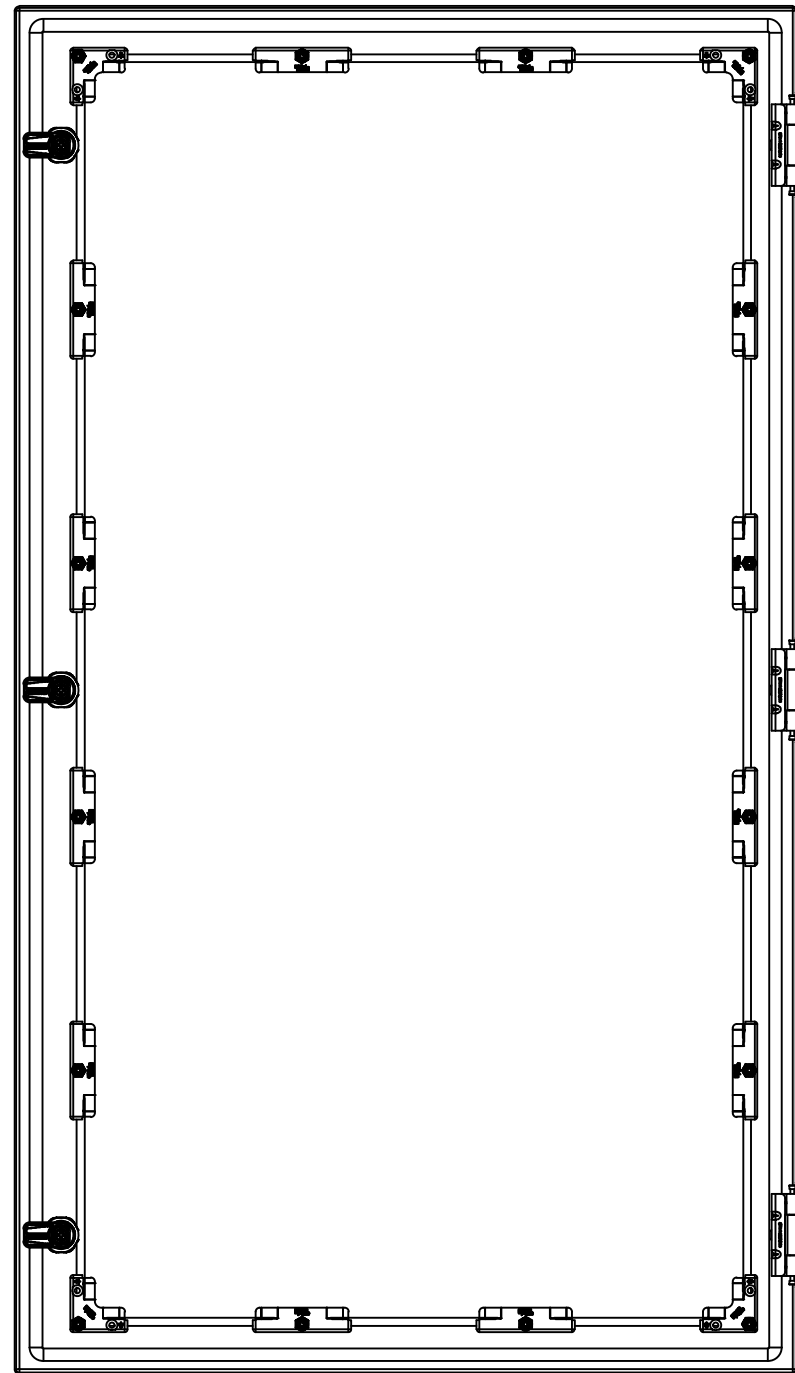

BACK

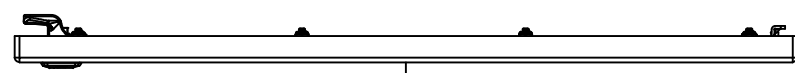

BOTTOM

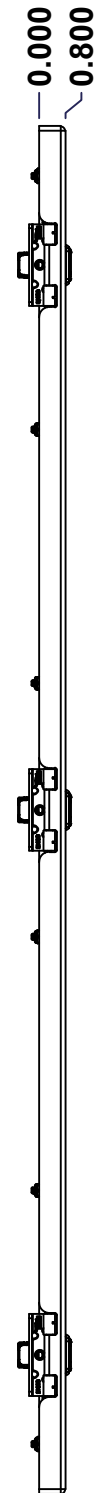

LEFT

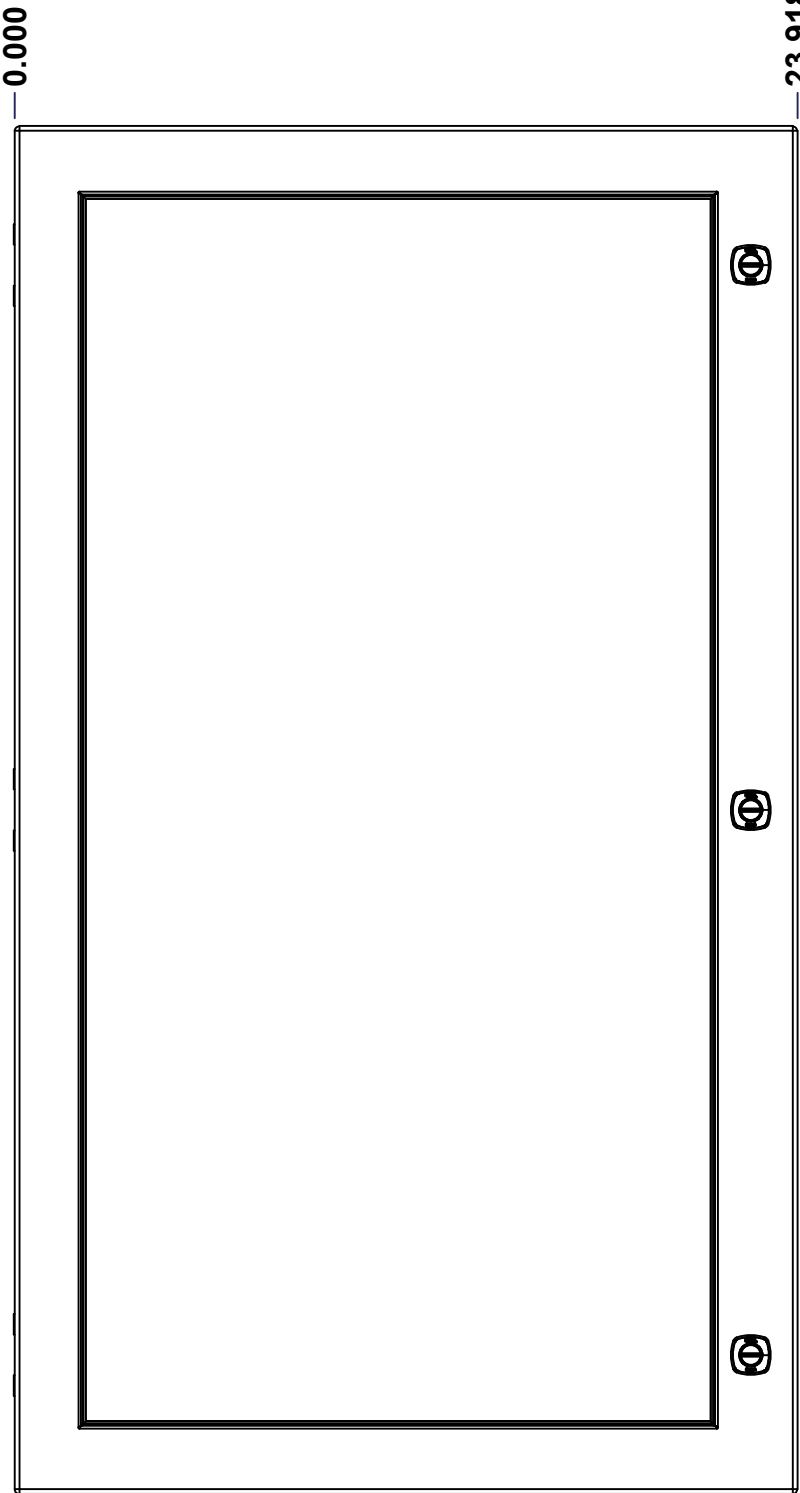

FRONT

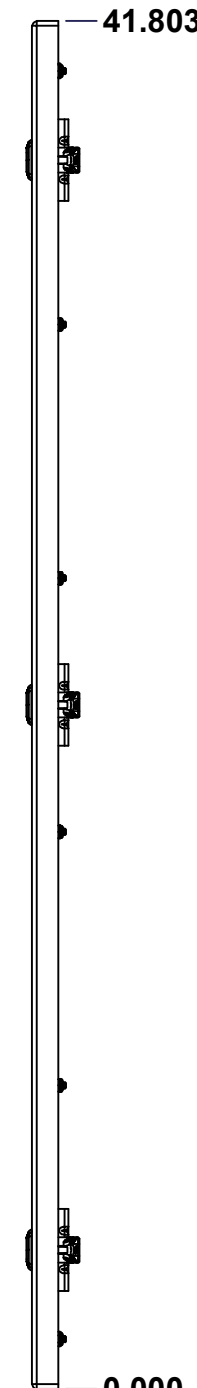

RIGHT

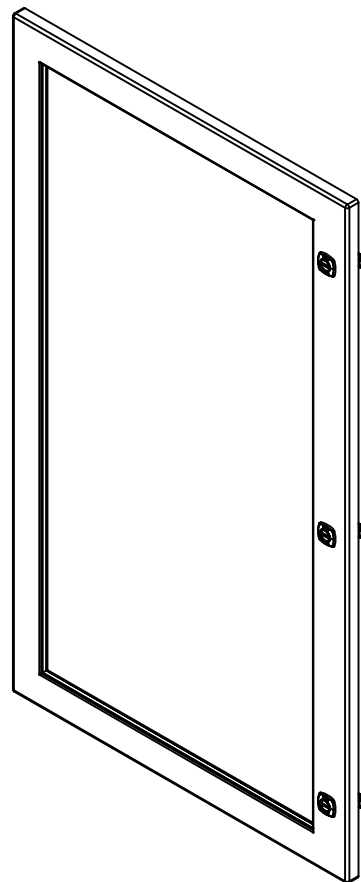

Isometric View

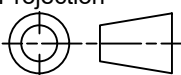

No.	Revisions	Date	By/Par

 Tél: (450) 979-4373 Fax: (450) 979-4626 www.exmweb.com		Flatness Aplatissement Max 3.0mm Projection 
Customer Client	Date	Date
Drawn By Dessiné Par	BoxCad: BoxCad	07-Jun-23
Material Matière	16 Ga Stainless Steel 304 (1.4mm)	
Color Couleur	Unpainted	Finish Fini Brushed
Description	Detail Rev.	
5412ESSW 42" x 24" Cover		
Part Number Numéro Pièce	Rev.	8
5412ESSW422408THC	0	15

SEE BILL OF MATERIAL ON LAST PAGE

This drawing is confidential and must not be reproduced or used without the consent of EXM

Ce dessin est confidentiel et ne doit pas être reproduit ou utilisé sans le consentement de EXM

STANDARD FEATURES ARE NOT LISTED IN THIS HOLE TABLE			
HOLE TABLE - FRONT VIEW (CUSTOM FEATURE ONLY)			
CUT-OUT	XDIM	YDIM	DESCRIPTION
1	1.469	9.277	STUD M6 x 18mm (Inside)
2	21.968	9.277	STUD M6 x 18mm (Inside)
3	1.469	17.027	STUD M6 x 18mm (Inside)
4	21.968	17.027	STUD M6 x 18mm (Inside)
5	1.469	24.776	STUD M6 x 18mm (Inside)
6	21.968	24.776	STUD M6 x 18mm (Inside)
7	1.469	32.526	STUD M6 x 18mm (Inside)
8	21.968	32.526	STUD M6 x 18mm (Inside)
9	1.469	40.276	STUD M6 x 18mm (Inside)
10	1.469	1.527	STUD M6 x 18mm (Inside)
11	8.302	40.276	STUD M6 x 18mm (Inside)
12	8.302	1.527	STUD M6 x 18mm (Inside)
13	15.135	40.276	STUD M6 x 18mm (Inside)
14	15.135	1.527	STUD M6 x 18mm (Inside)
15	21.968	40.276	STUD M6 x 18mm (Inside)
16	21.968	1.527	STUD M6 x 18mm (Inside)

17	22.494	4.250	880 SCQ4-SLSS6
18	22.494	20.902	880 SCQ4-SLSS6
19	22.494	37.553	880 SCQ4-SLSS6

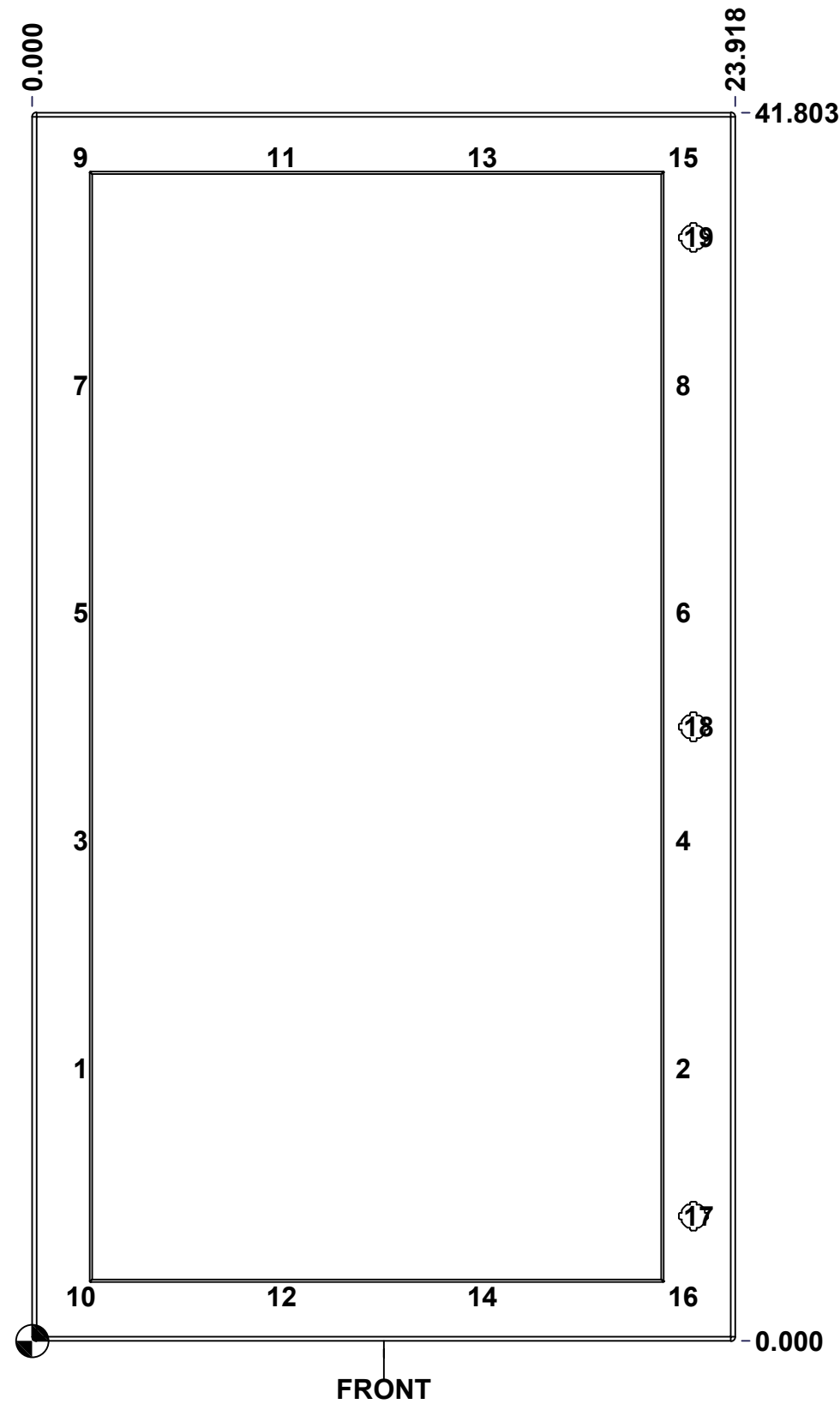

	Description	Status
	5412ESSW 42" x 24" Cover	(NULL)
	Part Number Numéro Pièce	Rev.
	5412ESSW422408THC	0 / 9
		15

This drawing is confidential and must not be reproduced or used without the consent of EXM

Ce dessin est confidentiel et ne doit pas être reproduit ou utilisé sans le consentement de EXM

No.	Revisions	Date	By/Par

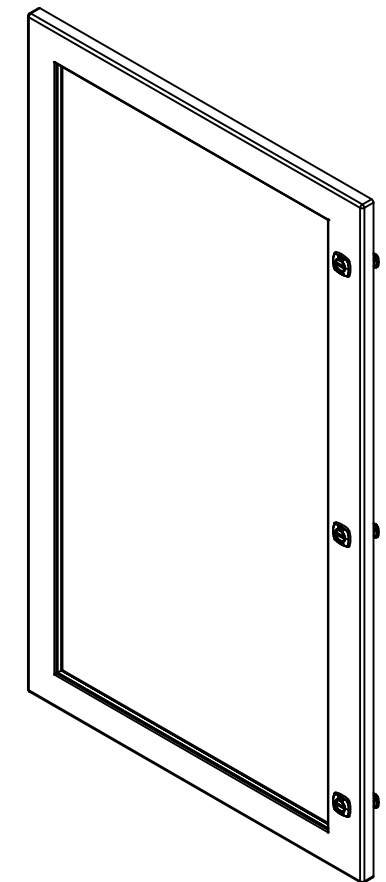

Isometric View

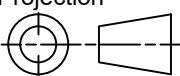

QTY	Part Number	Rev	Description
12	STK-Q-60701	2.1	880 WK - Lexan 1/4" Fixing Bracket
1	STK-A-60703	0	5412 ESW Lexan Bracket Kit
16	STK-Q-16053	1	Stud M6 x 23mm Stainless steel
1	STK-G-02710	0	880 HWKG - Windows Kit Gasket
1	5412ESSW422408THLXG	0	5412ESSW 42" x 24" Lexan Gasket Part
1	5412ESSW422408THLX	0	5412ESSW 38.375" x 20.125" Lexan Part
1	5412ESSW422408THG	0	5412ESSW 42" x 24" Cover Gasket Part
1	5412ESSW422408THC-P	0	5412ESSW 42" x 24" Cover Part
3	880 SCQ4-SLSS6	7	5412 ESS 1/4 Turn Lock
3	STK-A-33016	0	5412 ESS Bended Hinge (Body Part)
Parts List			

 Tél: (450) 979-4373 Fax: (450) 979-4626 www.exmweb.com		Flatness Aplatissement Max 3.0mm Projection 
Customer Client	Date	
Drawn By Dessiné Par	BoxCad: BoxCad	Date 07-Jun-23
Material Matière	16 Ga Stainless Steel 304 (1.4mm)	
Color Couleur	Unpainted	Finish Fini Brushed
Description		Detail Rev.
5412ESSW 42" x 24" Cover		
Part Number Numéro Pièce	Rev.	10
5412ESSW422408THC	0	15

This drawing is confidential and must not be reproduced or used without the consent of EXM

Ce dessin est confidentiel et ne doit pas être reproduit ou utilisé sans le consentement de EXM

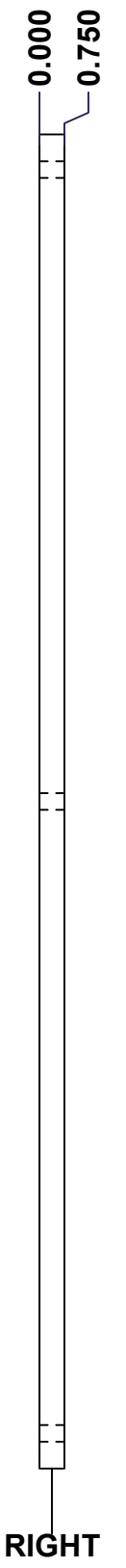
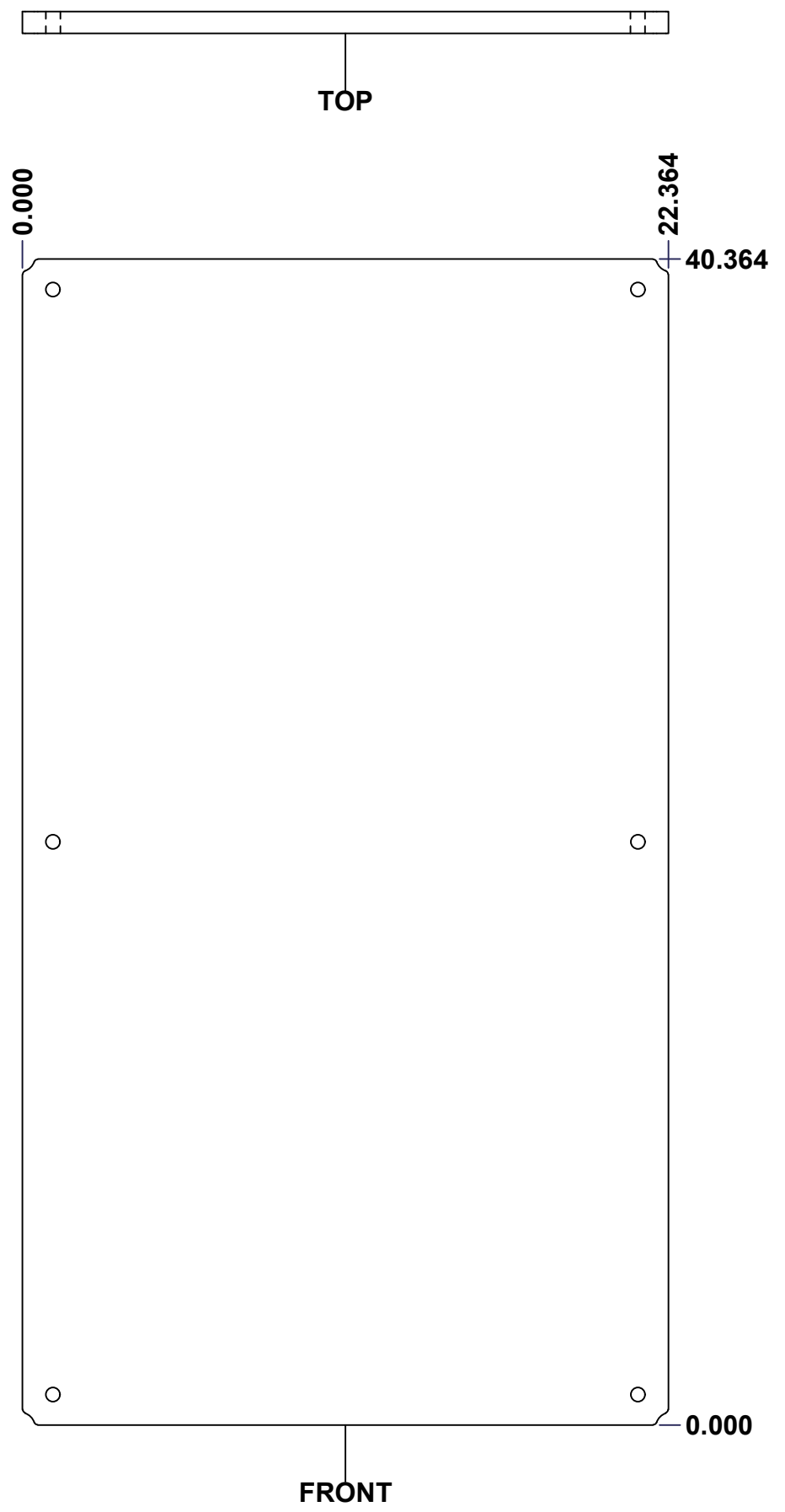

No.	Revisions	Date	By/Par

Isometric View

<p>Tél: (450) 979-4373 Fax: (450) 979-4626 www.exmweb.com</p>		Flatness Aplatissement	
		Max 3.0mm	
Customer Client		Date	
Drawn By Dessiné Par		Date	
Material Matière		Polyisocyanurate	
Color Couleur		Finish Fini	
Aluminum		N/A	
Description			Detail Rev.
5412ESSW 42" x 24" Back Insulation			
Part Number Numéro Pièce		Rev.	
5412ESSW422408TH-B		0	11 15

SEE BILL OF MATERIAL ON LAST PAGE

This drawing is confidential and must not be reproduced or used without the consent of EXM

Ce dessin est confidentiel et ne doit pas être reproduit ou utilisé sans le consentement de EXM

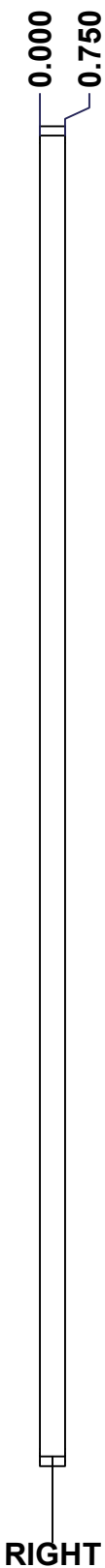
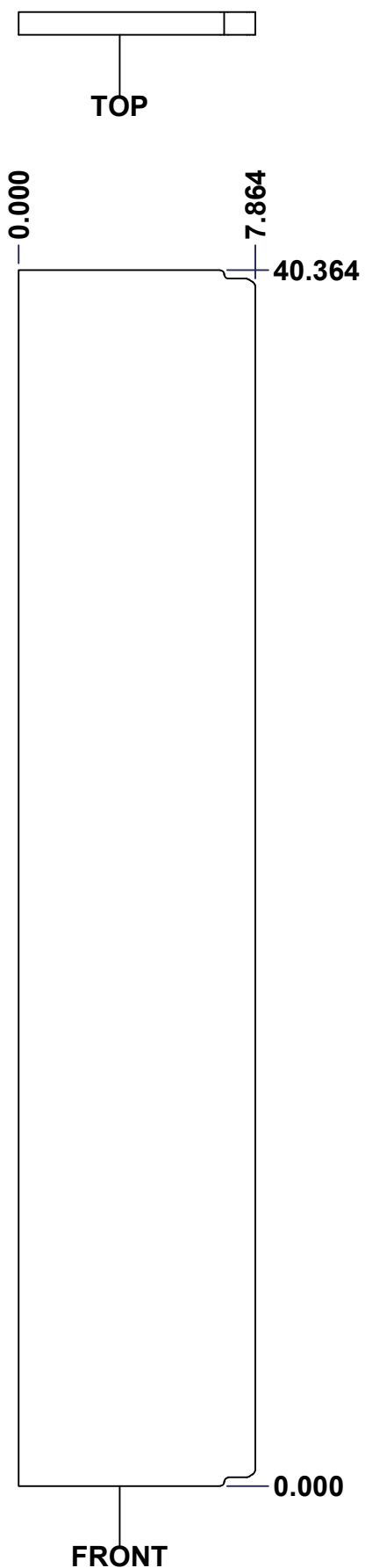

Isometric View



Tél: (450) 979-4373
 Fax: (450) 979-4626
www.exmweb.com

Flatness
Aplatissement

Max 3.0mm

Projection



Customer Client	Date
-----------------	------

Drawn By Dessiné Par	BoxCad: Patrick Deschenes	Date	23-Jan-07
-------------------------	---------------------------	------	-----------

Material Matière	Polyisocyanurate
---------------------	------------------

Color Couleur	Aluminum	Finish Fini	N/A
------------------	----------	----------------	-----

Description	Detail Rev.
5412ESSW 42" x 24" Left Insulation	

Part Number Numéro Pièce	Rev.	12
5412ESSW422408THI-LS	0	15

SEE BILL OF MATERIAL ON LAST PAGE

This drawing is confidential and must not be reproduced or used without the consent of EXM

Ce dessin est confidentiel et ne doit pas être reproduit ou utilisé sans le consentement de EXM

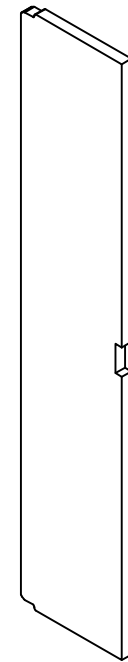
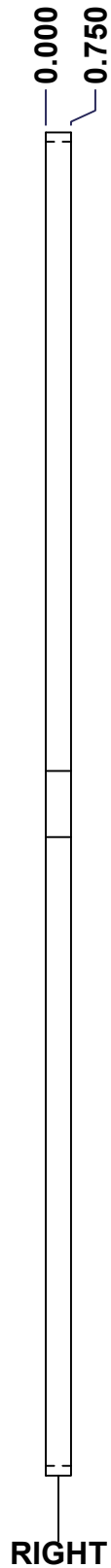
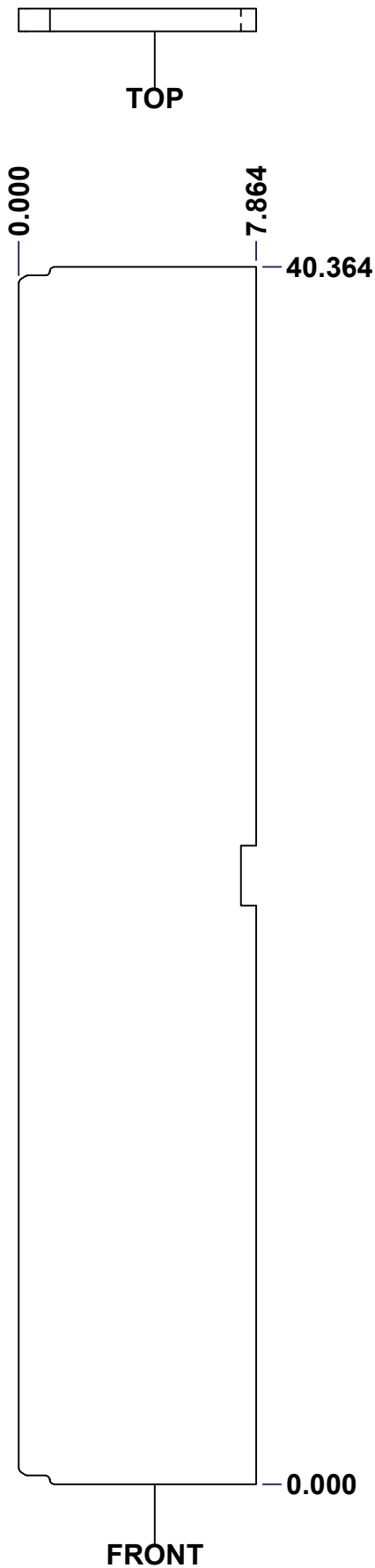

Isometric View

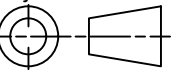

No.	Revisions	Date	By/Par

 Tél: (450) 979-4373 Fax: (450) 979-4626 www.exmweb.com		Flatness Aplatissement Max 3.0mm Projection 
Customer Client	Date	
Drawn By Dessiné Par	BoxCad: Patrick Deschenes	Date 23-Jan-07
Material Matière	Polyisocyanurate	
Color Couleur	Aluminum	Finish Fini N/A
Description 5412ESSW 42" x 24" Right Insulation		Detail Rev.
Part Number Numéro Pièce	Rev. 0	13 15

SEE BILL OF MATERIAL ON LAST PAGE

5412ESSW422408THI-RS

This drawing is confidential and must not be reproduced or used without the consent of EXM

Ce dessin est confidentiel et ne doit pas être reproduit ou utilisé sans le consentement de EXM



TOP

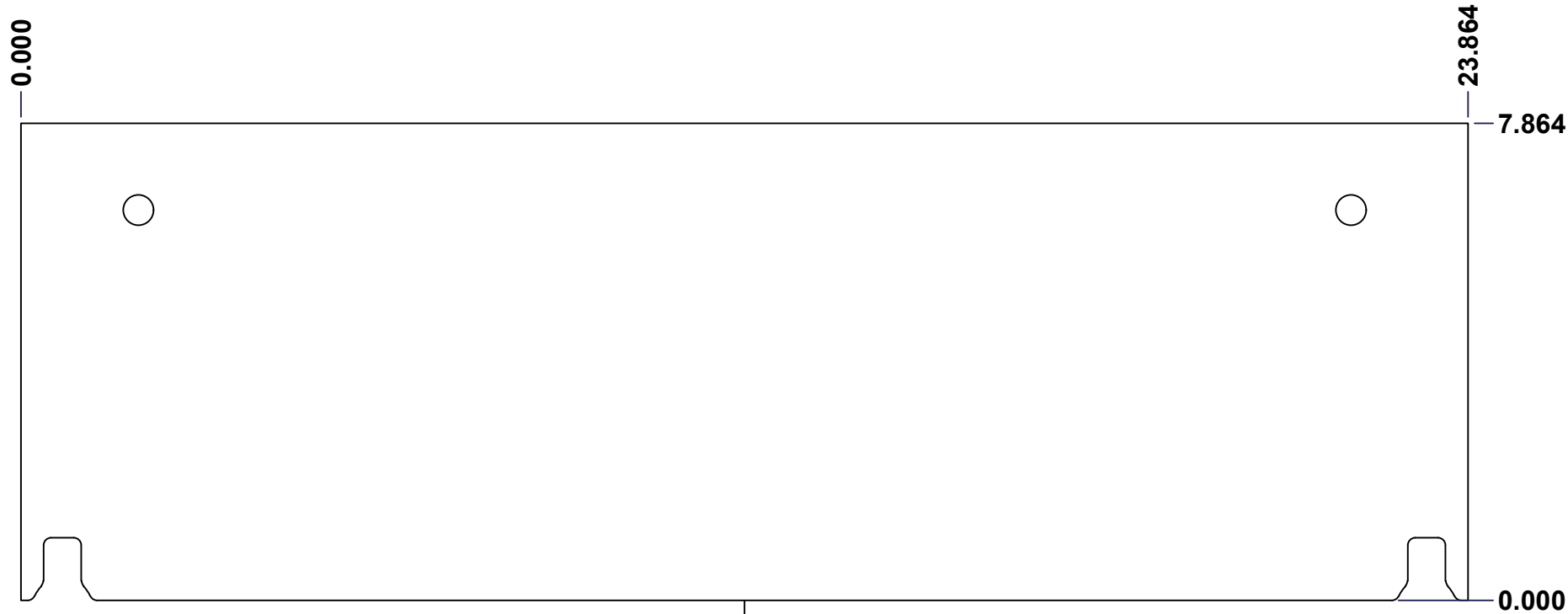

FRONT

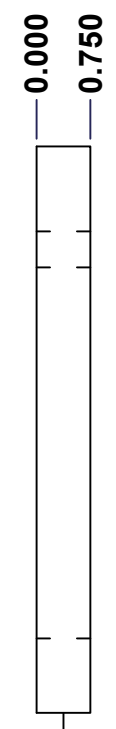

RIGHT

No.	Revisions	Date	By/Par

Isometric View

Tél: (450) 979-4373 Fax: (450) 979-4626 www.exmweb.com		Flatness Aplatissement	
		Max 3.0mm	
Customer Client		Date	
Drawn By Dessiné Par		Date	
Material Matière		Polyisocyanurate	
Color Couleur		Finish Fini	
Description		Detail Rev.	
Part Number Numéro Pièce		Rev.	

SEE BILL OF MATERIAL ON LAST PAGE

5412ESSW422408THI-TP

Rev. 0
14
15

This drawing is confidential and must not be reproduced or used without the consent of EXM

Ce dessin est confidentiel et ne doit pas être reproduit ou utilisé sans le consentement de EXM



TOP

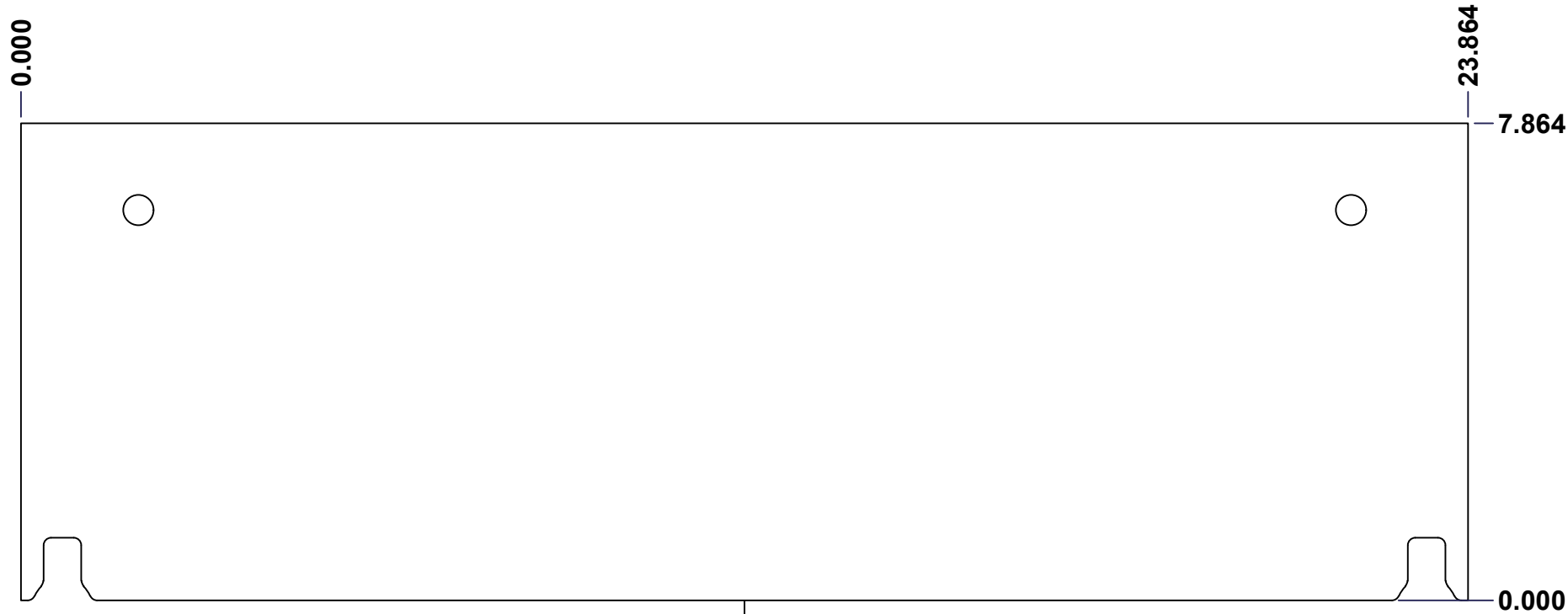

FRONT

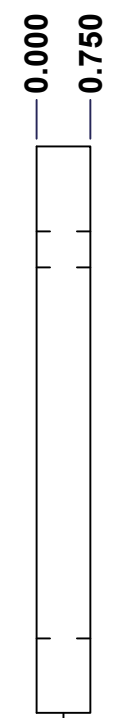

RIGHT

No.	Revisions	Date	By/Par

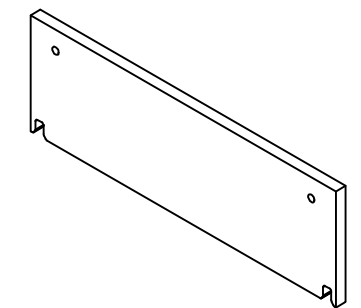

Isometric View

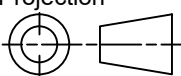

 Tél: (450) 979-4373 Fax: (450) 979-4626 www.exmweb.com	Flatness Aplatissement	Max 3.0mm
	Projection	
Customer Client	Date	
Drawn By Dessiné Par	BoxCad: Patrick Deschenes	Date 23-Jan-07
Material Matière	Polyisocyanurate	
Color Couleur	Aluminum	Finish Fini N/A
Description	Detail Rev.	
5412ESSW 42" x 24" Top and Bottom Insulation		
Part Number Numéro Pièce	Rev.	15
5412ESSW422408THI-BT	0	15

SEE BILL OF MATERIAL ON LAST PAGE

This drawing is confidential and must not be reproduced or used without the consent of EXM

Ce dessin est confidentiel et ne doit pas être reproduit ou utilisé sans le consentement de EXM

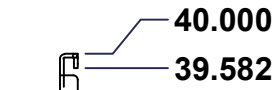
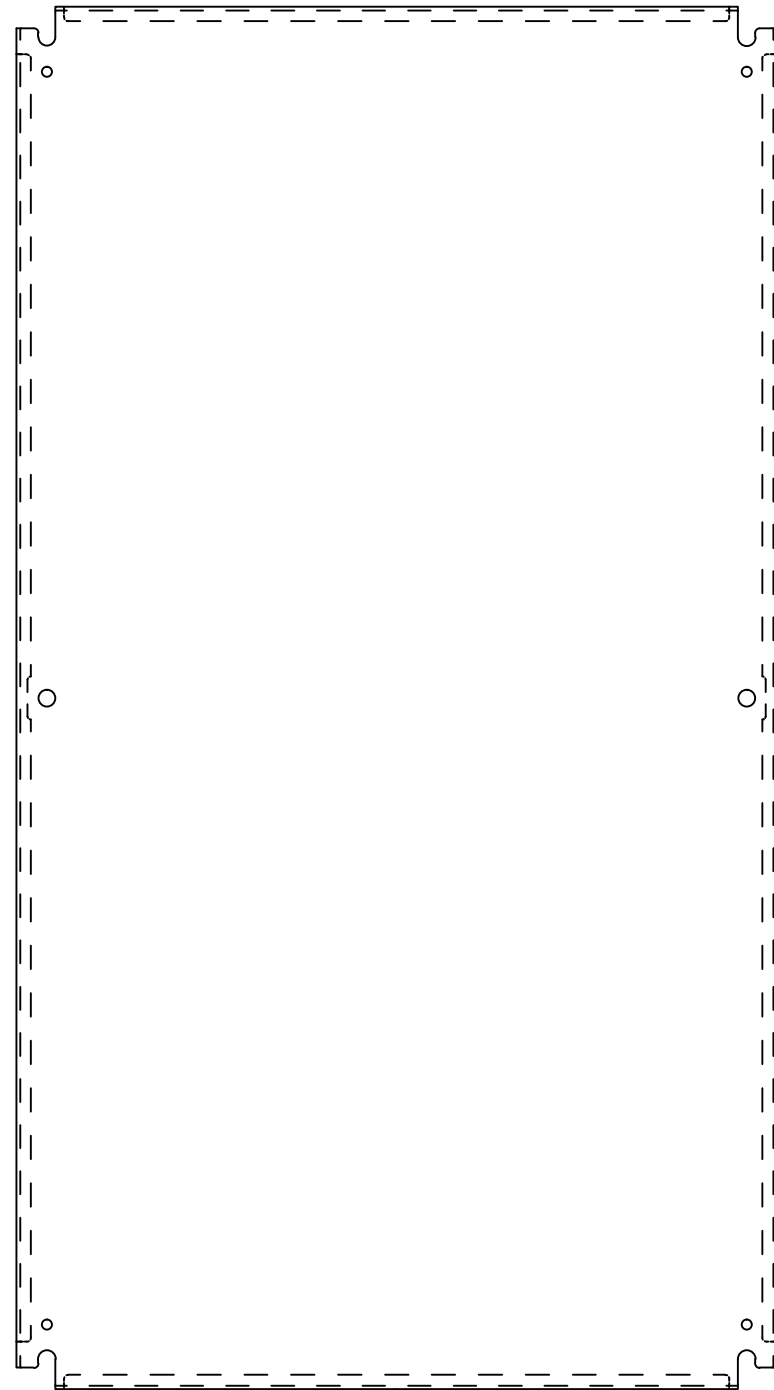
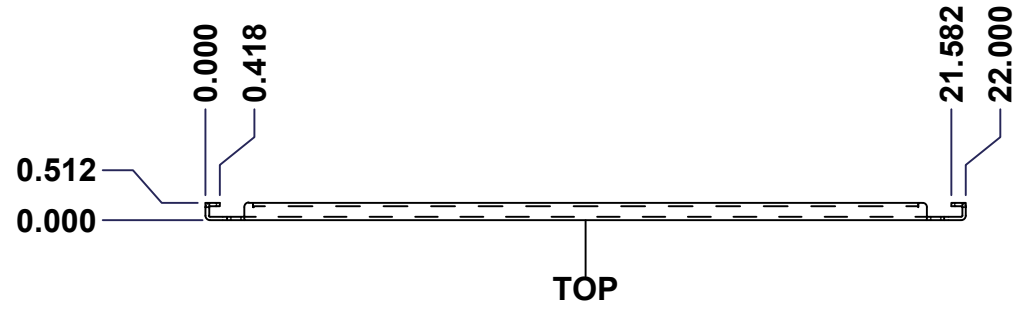

No.	Revisions	Date	By/Par

Isometric View

Tél: (450) 979-4373 Fax: (450) 979-4626 www.exmweb.com		Flatness Aplatissement Max 3.0mm Projection
Customer Client	Date	
Drawn By Dessiné Par: BoxCad	Date: 23-Jan-07	
Material Matière	See Part List	
Color Couleur	See Part List	Finish Fini: See Part List
Description: 881 SP - Inner Panel		Detail Rev.
Part Number Numéro Pièce: 881 SP4224G	Rev. 0	1 2

Qty	Part Number	Rev	Description	Material	Color	Finish
1	881 SP4224G-P	0	881 SP - Inner Panel Part	12 Ga Galvanized	Unpainted	Galvanized

Parts List

This drawing is confidential and must not be reproduced or used without the consent of EXM

Ce dessin est confidentiel et ne doit pas être reproduit ou utilisé sans le consentement de EXM

Table 1			FRONT VIEW
CUT-OUT	XDIM	YDIM	DESCRIPTION
1	0.875	1.875	GROUND HOLE (RND Ø0.290)
2	21.125	1.875	GROUND HOLE (RND Ø0.290)
3	0.875	38.125	GROUND HOLE (RND Ø0.290)
4	21.125	38.125	GROUND HOLE (RND Ø0.290)
5	0.875	20.000	MTG STUD HOLE (RND Ø0.500)
6	21.125	20.000	MTG STUD HOLE (RND Ø0.500)

All knockouts are actual size / Les disques défonçables sont grandeur réel

No.	Revisions	Date	By/Par

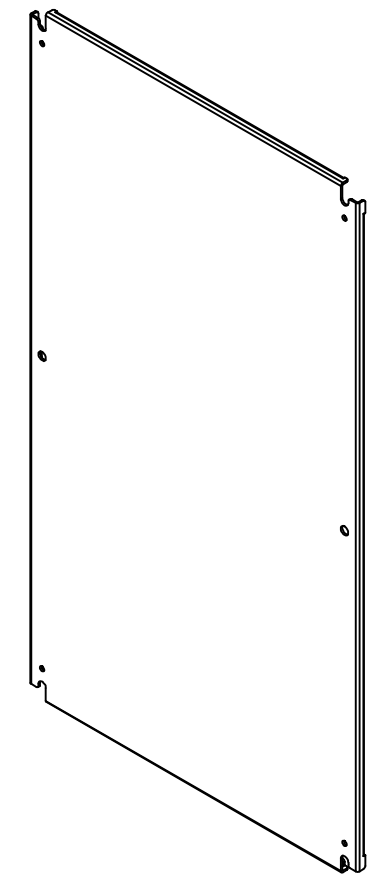
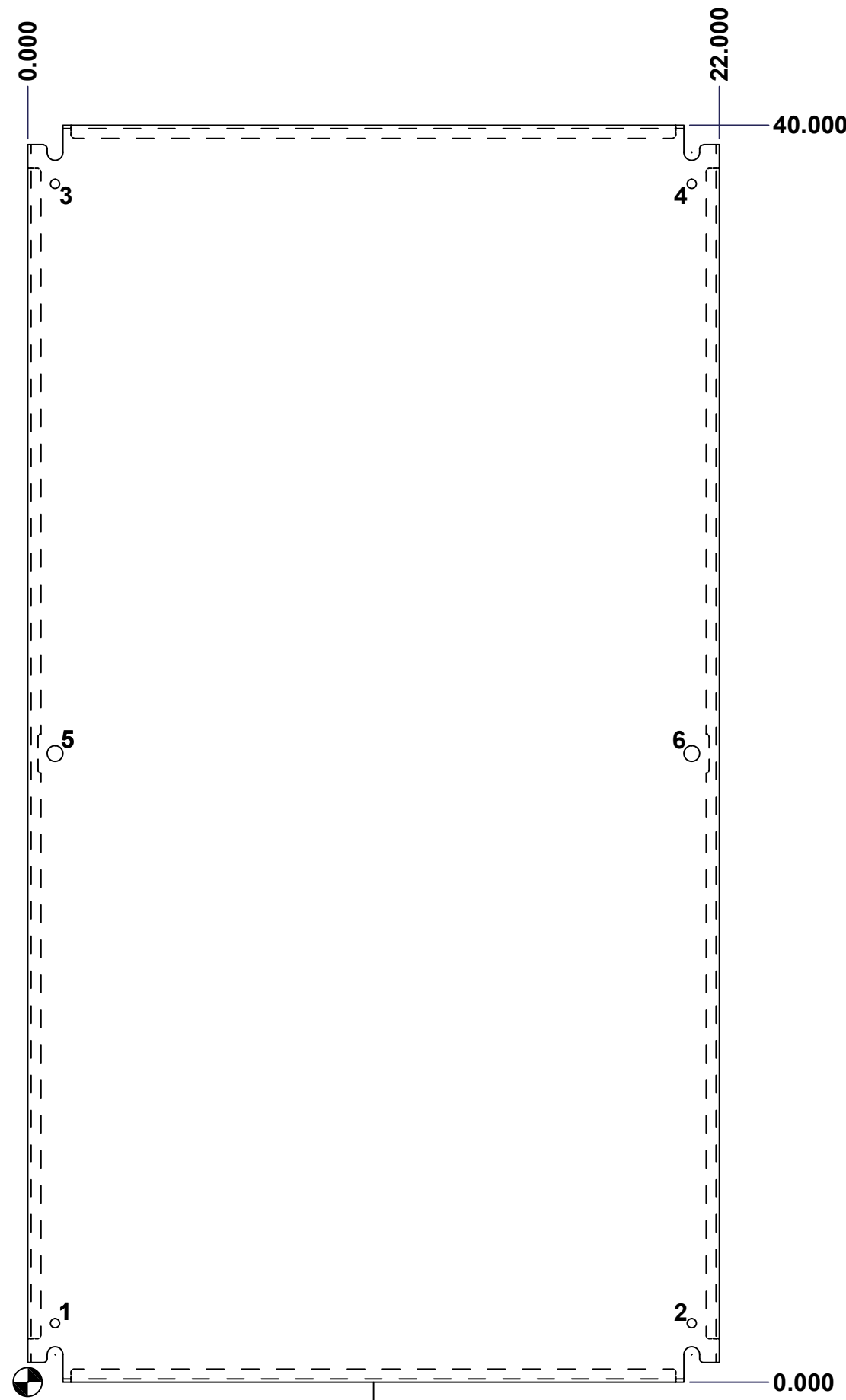

Isometric View



	Tél: (450) 979-4373 Fax: (450) 979-4626 www.exmweb.com	Flatness Aplatissement
		Max 3.0mm
Projection		
Customer Client		Date
Drawn By Dessiné Par	BoxCad	Date 23-Jan-07
Material Matière	See Part List	
Color Couleur	See Part List	Finish Fini See Part List
Description		Detail Rev.
881 SP - Inner Panel		
Part Number Numéro Pièce	Rev.	2
881 SP4224G	0	2