

This drawing is confidential and must not be reproduced or used without the consent of EXM

Ce dessin est confidentiel et ne doit pas être reproduit ou utilisé sans le consentement de EXM

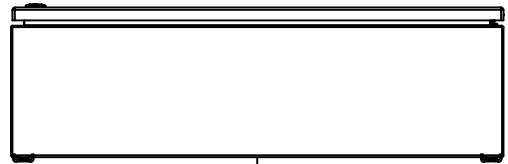

TOP

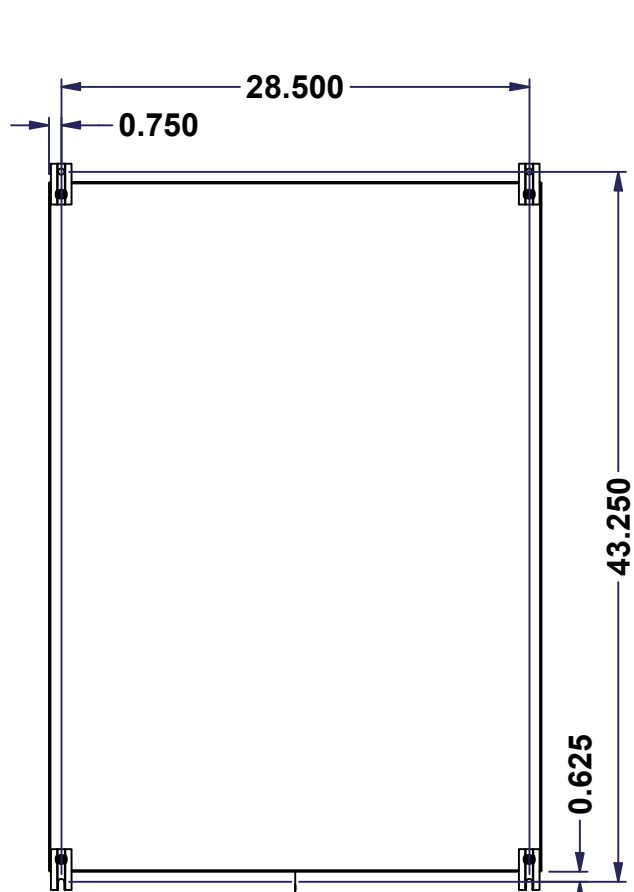

BACK

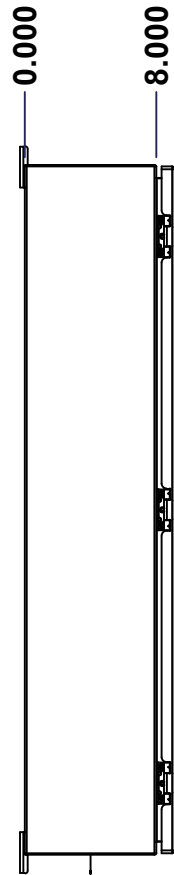

LEFT

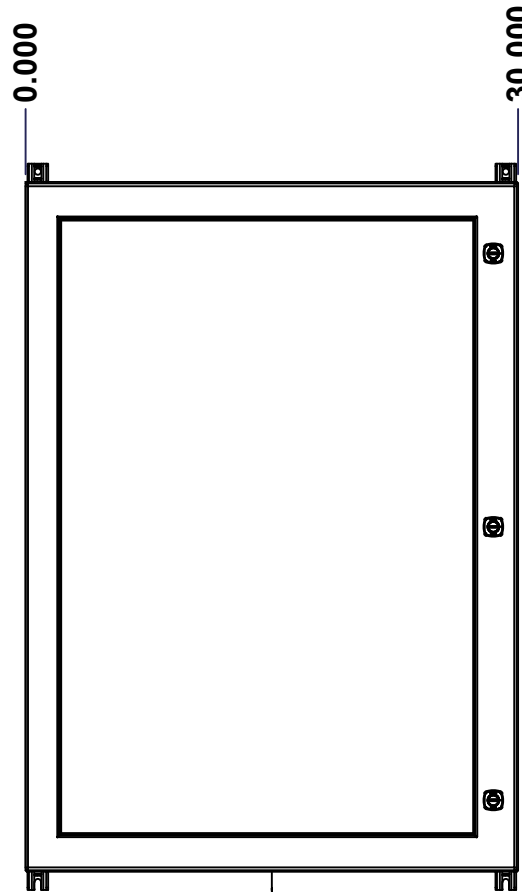

FRONT

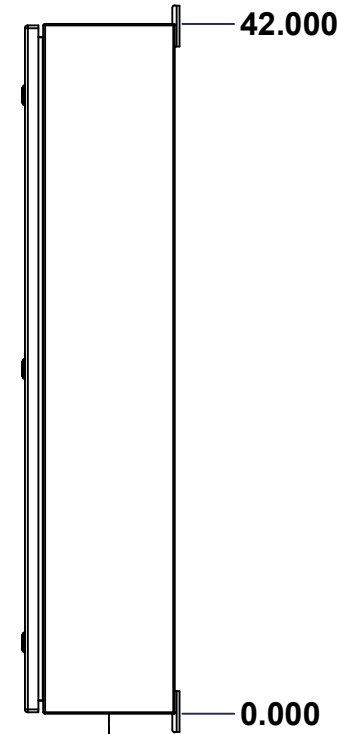

RIGHT

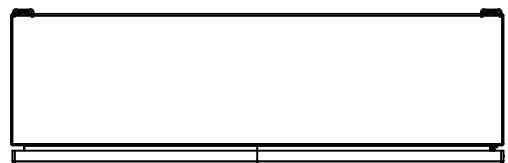

BOTTOM

No.	Revisions	Date	By/Par

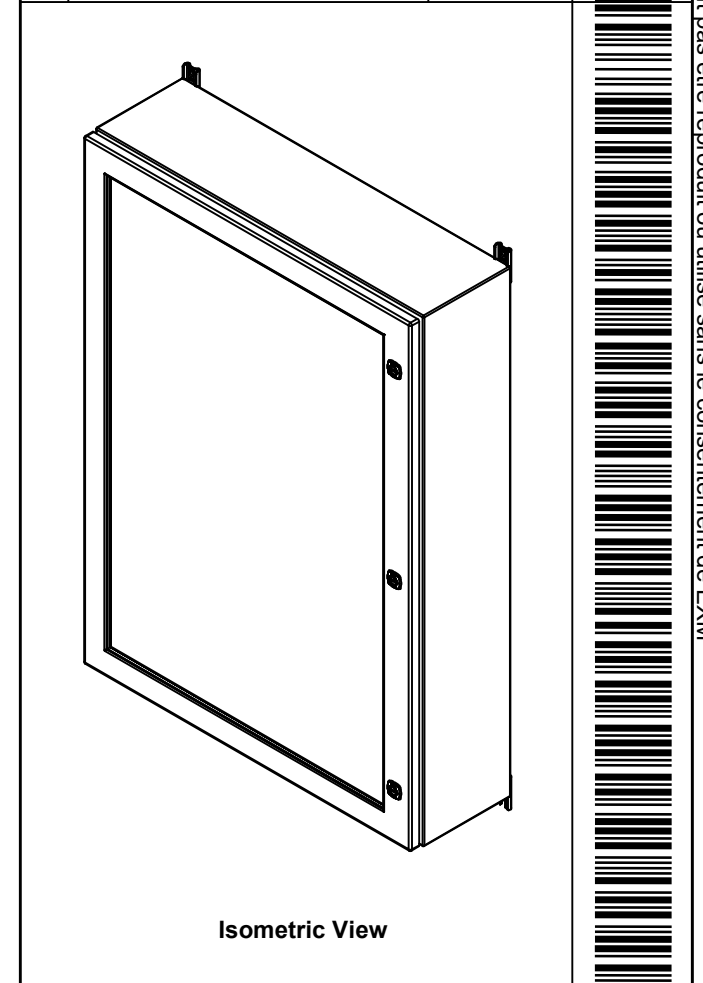

Isometric View



**GRAIN DIRECTION:
TOP/BOTTOM: HORIZONTAL
LEFT/RIGHT/BACK/FRONT: VERTICAL**

	Flatness Aplatissement Max 3.0mm
	Projection
Customer Client	Date
Drawn By Dessiné Par BoxCad: BoxCad	Date 07-Jun-23
Material Matière 14 Ga Stainless Steel 316 (1.7mm)	
Color Couleur Unpainted	Finish Fini Brushed
Description 5412ESSW 42" x 30" x 8" Assembly	
Part Number Numéro Pièce	Rev. 1 0

SEE BILL OF MATERIAL ON LAST PAGE 5412ESSW4230086THNOIP

This drawing is confidential and must not be reproduced or used without the consent of EXM

Ce dessin est confidentiel et ne doit pas être reproduit ou utilisé sans le consentement de EXM

NOTE	
ITEM	DESCRIPTION
1	NEMA 4X Enclosure
2	C/W Standard ground studs on box and cover
3	W/O Standard door stiffener
4	W/O Inner panel
5	C/W Standard inner panel mounting studs
6	C/W 885 ESMF4_OPEN Sold separately (Installed)
7	C/W 885 ESMF4_CLOSE Sold separately (Installed)
8	C/W R5 Insulation (Installed by EXM)

No.	Revisions	Date	By/Par

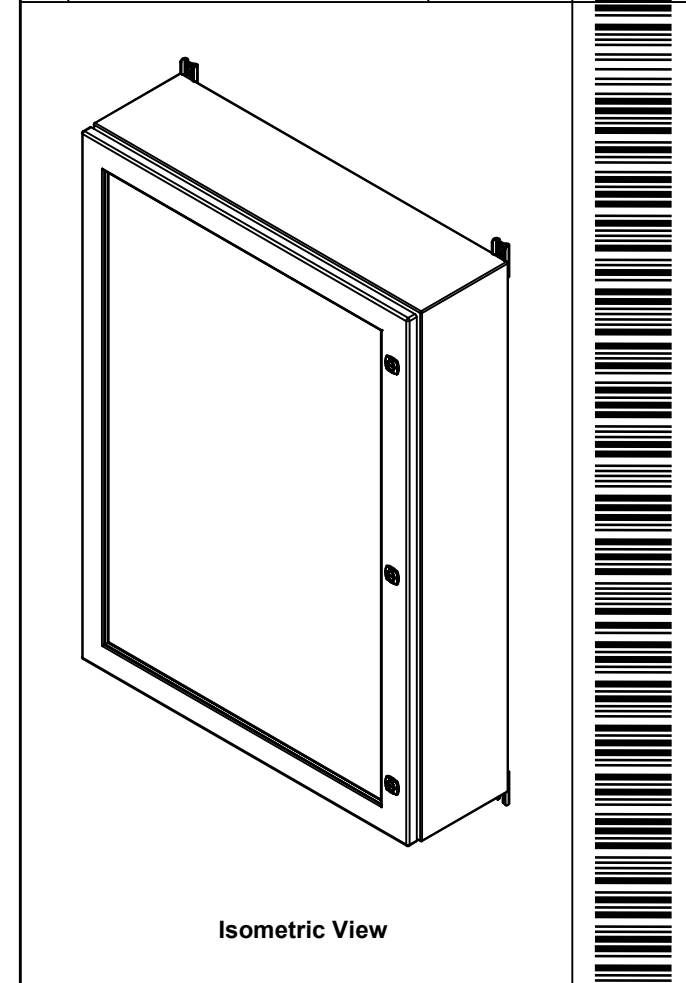

PACKING		
ITEM	QTY	DESCRIPTION
Cardboard sleeve	2	Top and Bottom
Cardboard strip	2	Between back of enclosure and inner panel
Plastic bag	1	To protect cover surface and inside gasket
Cardboard corner	4	To reinforced for the plastic strap tightening
Plastic strap - Black	2	To Squeeze the 2 cardboard sleeve together
Packaging label	3	White label with PN
Plastic strap- Green	2	To secure the enclosure to the wood pallet
Wood Pallet	1	2" deeper and 3" larger than enclosure size

6	STK-Q-00600	2	M12 to M8 Adaptor
1	STK-K-01800	5	5412 ES Accessory Kit
1	5412ESSW4230086THNO IPC	0	5412ESSW 42" x 30" Cover
1	5412ESSW4230086THNO IPB	0	5412ESSW 42" x 30" x 8" Body
3	STK-Q-04051-08	1	M6 x 8mm Stainless Steel Hexagon Socket Head Machine Screw with Nyseal
Qty	Part Number	Rev	Description
Parts List			

Tél: (450) 979-4373
Fax: (450) 979-4626
www.exmweb.com

Flatness
Aplatissement
Max 3.0mm

Projection

Customer Client	Date
Drawn By Dessiné Par BoxCad: BoxCad	Date 07-Jun-23
Material Matière	14 Ga Stainless Steel 316 (1.7mm)
Color Couleur	Unpainted
Finish Fini	Brushed
Description	Detail Rev.
5412ESSW 42" x 30" x 8" Assembly	
Part Number Numéro Pièce	Rev. 2
5412ESSW4230086THNOIP	0

This drawing is confidential and must not be reproduced or used without the consent of EXM

Ce dessin est confidentiel et ne doit pas être reproduit ou utilisé sans le consentement de EXM

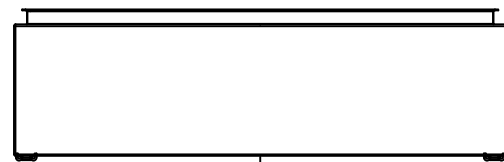

TOP

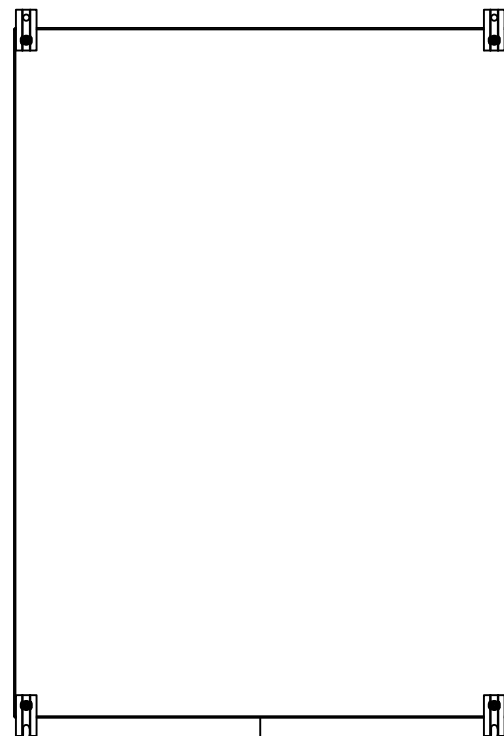

BACK

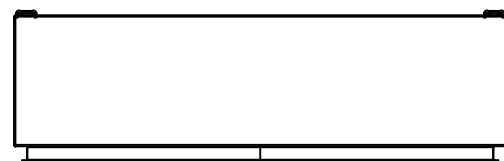

BOTTOM

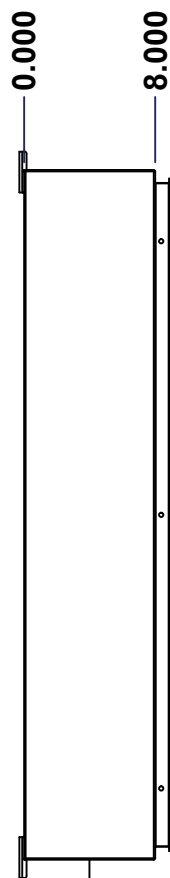

LEFT

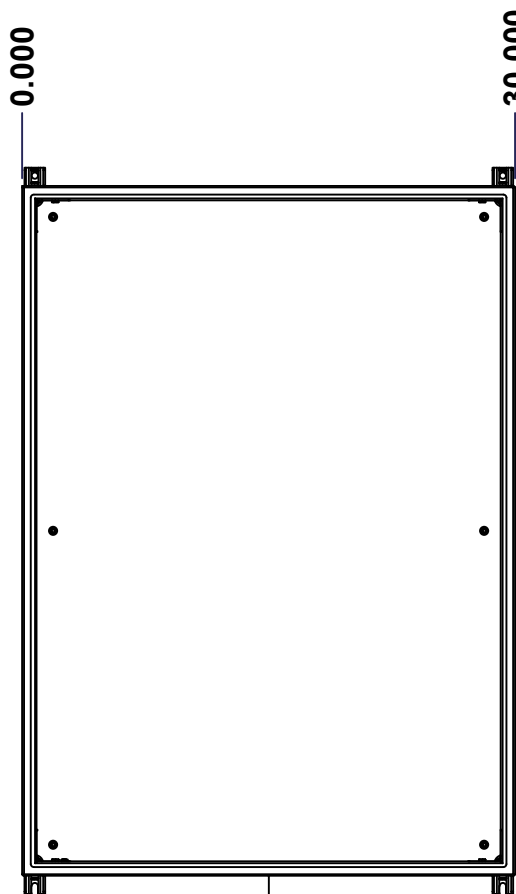

FRONT

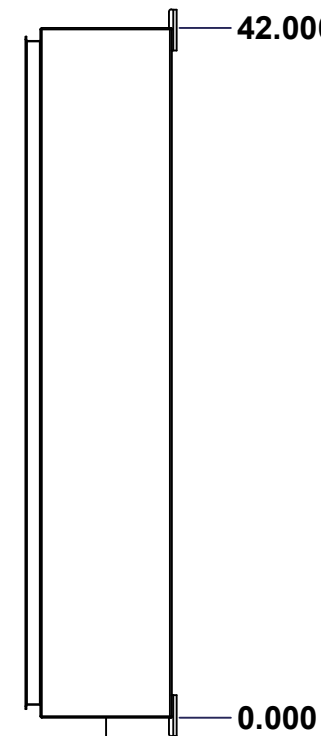

RIGHT

No.	Revisions	Date	By/Par

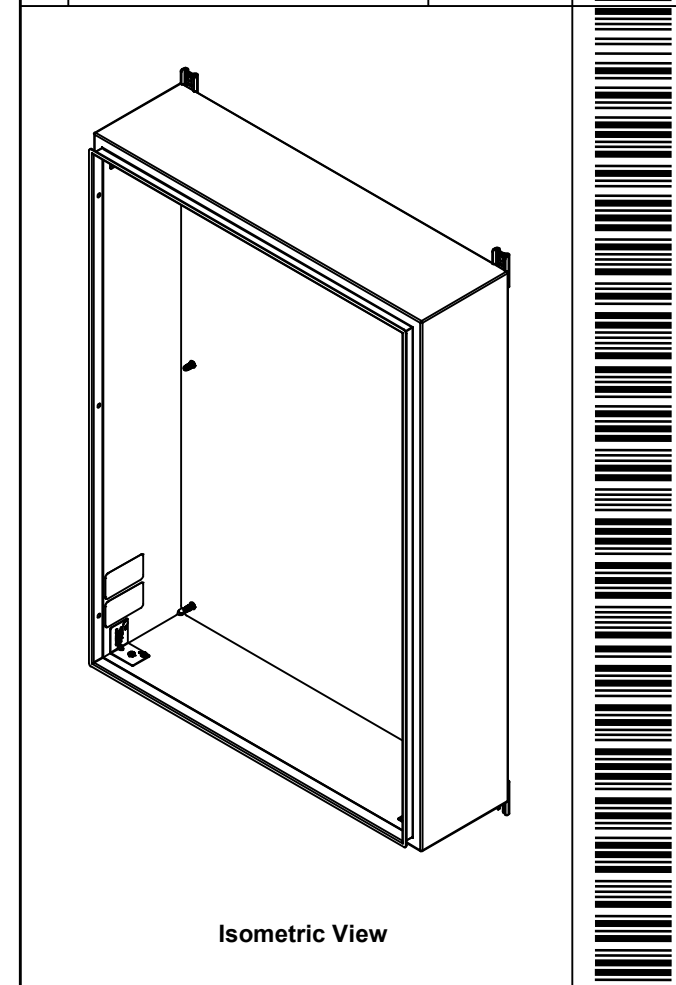

 Tél: (450) 979-4373
 Fax: (450) 979-4626
www.exmweb.com

Flatness / Aplatissement: Max 5.0mm
 Projection: 

Customer Client	Date
Drawn By / Dessiné Par: BoxCad: BoxCad	Date: 07-Jun-23

Material / Matière: 14 Ga Stainless Steel 316 (1.7mm)

Color / Couleur: Unpainted	Finish / Fini: Brushed
----------------------------	------------------------

Description: 5412ESSW 42" x 30" x 8" Body

Detail Rev.

Part Number / Numéro Pièce	Rev.	3
----------------------------	------	---

SEE BILL OF MATERIAL ON LAST PAGE 5412ESSW4230086THNOIPB 0

This drawing is confidential and must not be reproduced or used without the consent of EXM

Ce dessin est confidentiel et ne doit pas être reproduit ou utilisé sans le consentement de EXM

STANDARD FEATURES ARE NOT LISTED IN THIS HOLE TABLE			
HOLE TABLE - TOP VIEW (CUSTOM FEATURE ONLY)			
CUT-OUT	XDIM	YDIM	DESCRIPTION
1	2.000	6.500	INSUL. STUD M6 x 18mm (Inside)
2	28.000	6.500	INSUL. STUD M6 x 18mm (Inside)

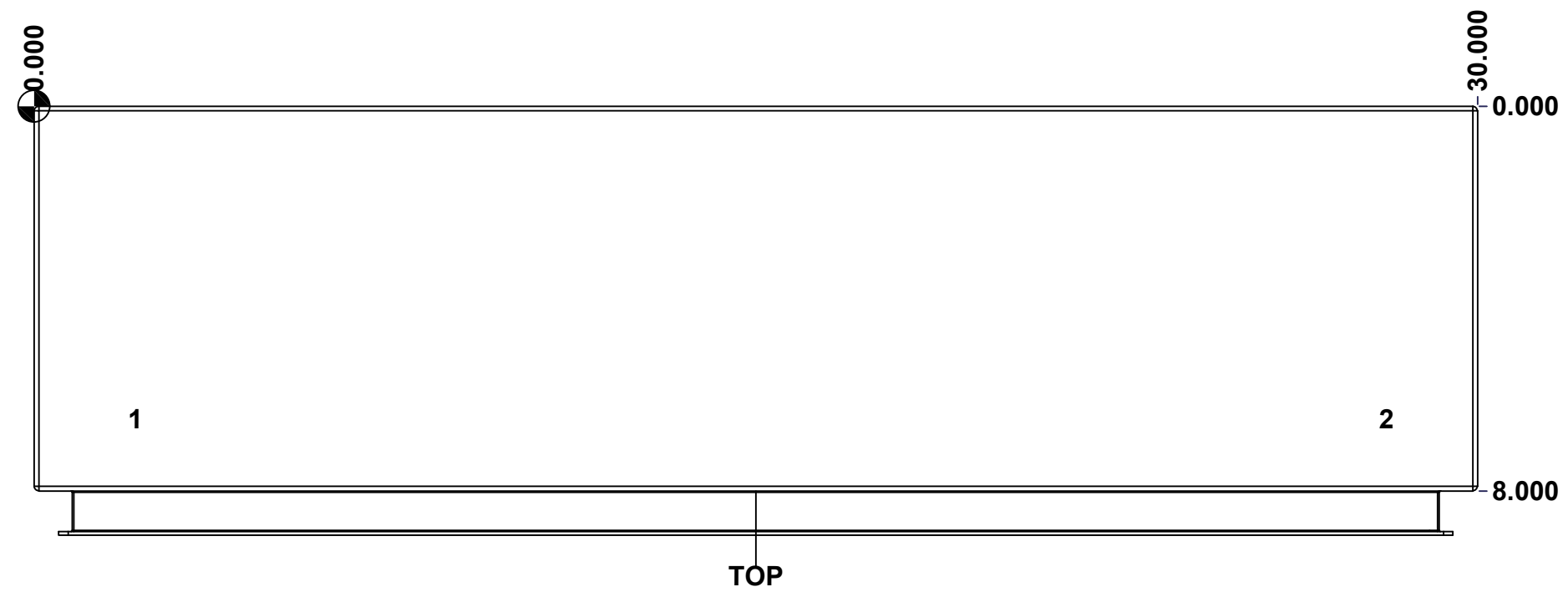

	Description	Status
	5412ESSW 42" x 30" x 8" Body	(NULL)
	Part Number Numéro Pièce	Rev.
	5412ESSW4230086THNOIPB 0	4
		15

This drawing is confidential and must not be reproduced or used without the consent of EXM

Ce dessin est confidentiel et ne doit pas être reproduit ou utilisé sans le consentement de EXM

STANDARD FEATURES ARE NOT LISTED IN THIS HOLE TABLE			
HOLE TABLE - BOTTOM VIEW (CUSTOM FEATURE ONLY)			
CUT-OUT	XDIM	YDIM	DESCRIPTION
1	2.000	6.500	INSUL. STUD M6 x 18mm (Inside)
2	28.000	6.500	INSUL. STUD M6 x 18mm (Inside)



	Description	Status
	5412ESSW 42" x 30" x 8" Body	(NULL)
	Part Number Numéro Pièce	Rev.
	5412ESSW4230086THNOIPB 0	5
		15

This drawing is confidential and must not be reproduced or used without the consent of EXM

Ce dessin est confidentiel et ne doit pas être reproduit ou utilisé sans le consentement de EXM

STANDARD FEATURES ARE NOT LISTED IN THIS HOLE TABLE

HOLE TABLE - BACK VIEW (CUSTOM FEATURE ONLY)

CUT-OUT	XDIM	YDIM	DESCRIPTION
1	1.875	1.875	IP STUD M8 x 35mm (Inside)
2	1.875	40.125	IP STUD M8 x 35mm (Inside)
3	28.125	40.125	IP STUD M8 x 35mm (Inside)
4	28.125	1.875	IP STUD M8 x 35mm (Inside)
5	1.875	21.000	IP STUD M8 x 35mm (Inside)
6	28.125	21.000	IP STUD M8 x 35mm (Inside)

7	29.250	0.000	FOOT 885 ESMF4_OPEN
8	0.750	0.000	FOOT 885 ESMF4_OPEN
9	29.250	42.000	FOOT 885 ESMF4_CLOSE
10	0.750	42.000	FOOT 885 ESMF4_CLOSE

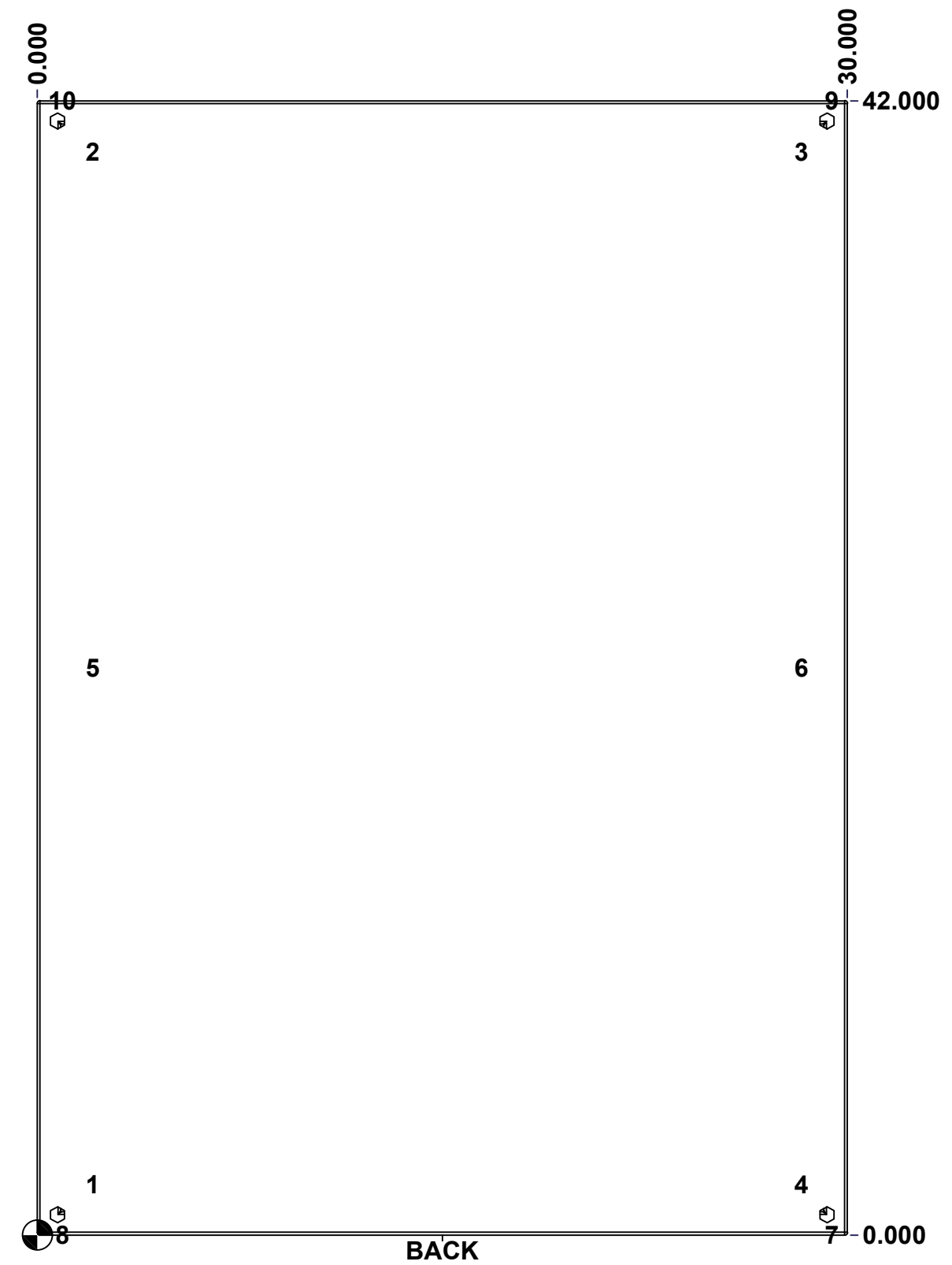

	Description	Status
	5412ESSW 42" x 30" x 8" Body	(NULL)
	Part Number Numéro Pièce	Rev.
	5412ESSW4230086THNOIPB 0	6
		15

This drawing is confidential and must not be reproduced or used without the consent of EXM

Ce dessin est confidentiel et ne doit pas être reproduit ou utilisé sans le consentement de EXM

No.	Revisions	Date	By/Par

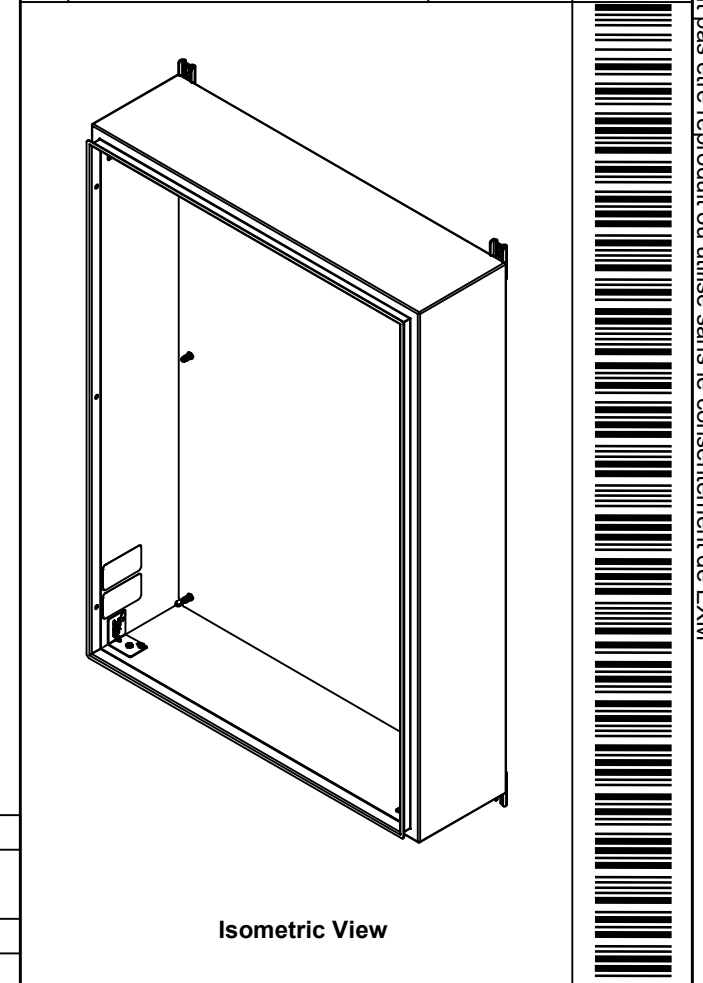

2	885ESMF4-FEET	0	885 ESMF4 Stainless Steel Mounting Foot
4	RIVET_NUT_SS_M10_FH_CE	0	Stainless Steel Rivet Nut M10 (Low Profile Close End)
4	STK-Q-06670	2	M10 x 16mm Stainless Steel Machine Screw
2	885ESMF4-FEET-A	0	885 ESMF4 Stainless Steel Mounting Foot (Opened Slot)
2	STK-S-00100	0	3.5" x 2" Silver Milar Flexcon Sticker
1	STK-K-70554	3	5412 ESTH Accessory Kit
1	5412ESSW4230086THNO IPI-RS	0	5412ESSW 42" x 30" Right Insulation
1	5412ESSW4230086THNO IPI-LS	0	5412ESSW 42" x 30" Left Insulation
1	5412ESSW4230086THNO IPI-BT	0	5412ESSW 42" x 30" Top and Bottom Insulation
1	5412ESSW4230086THNO IPI-TP	0	5412ESSW 42" x 30" Top and Bottom Insulation
1	5412ESSW4230086THNO IPI-B	0	5412ESSW 42" x 30" Back Insulation
4	STK-Q-16070	1	Stud M6 x 18mm Stainless steel
6	STK-Q-16020	1	Stud M8 x 35mm Stainless Steel
1	5412ESSW4230086THNO IPB-P	0	5412ESSW 42" x 30" x 8" Body Part

Qty	Part Number	Rev	Description
Parts List			



Tél: (450) 979-4373
Fax: (450) 979-4626
www.exmweb.com

Flatness
Aplatissement
Max 5.0mm

Projection

Customer Client	Date
Drawn By Dessiné Par: BoxCad: BoxCad	Date: 07-Jun-23
Material Matière: 14 Ga Stainless Steel 316 (1.7mm)	
Color Couleur: Unpainted	Finish Fini: Brushed
Description: 5412ESSW 42" x 30" x 8" Body	Detail Rev.
Part Number Numéro Pièce: 5412ESSW4230086THNOIPB 0	Rev. 7

This drawing is confidential and must not be reproduced or used without the consent of EXM

Ce dessin est confidentiel et ne doit pas être reproduit ou utilisé sans le consentement de EXM

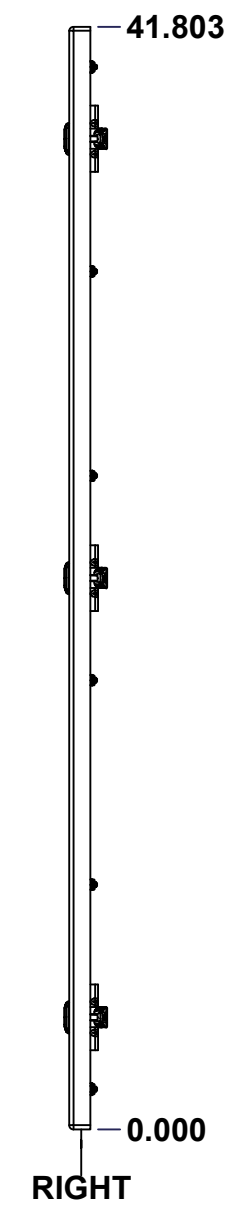
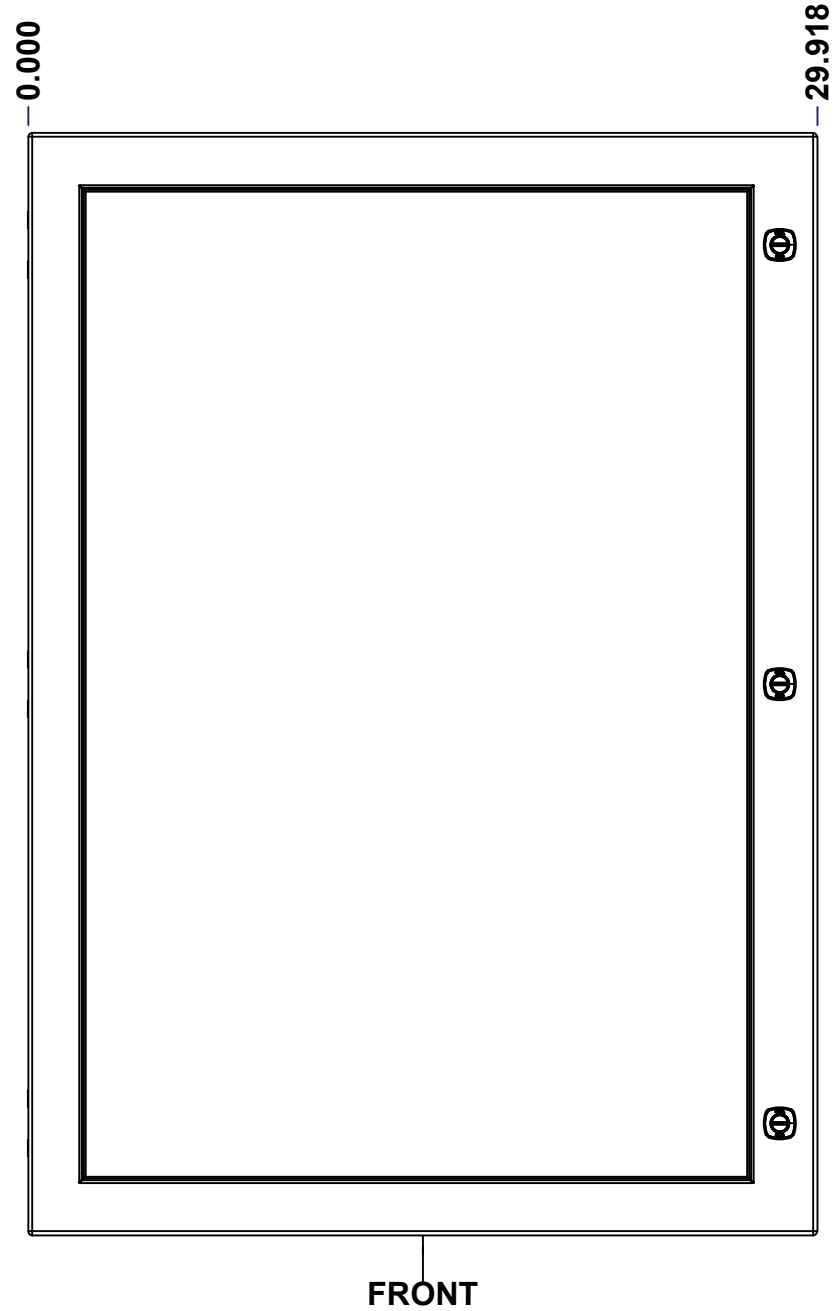
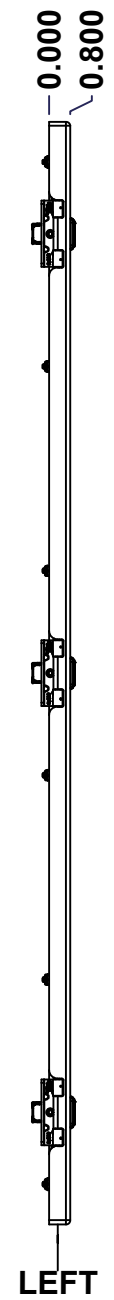
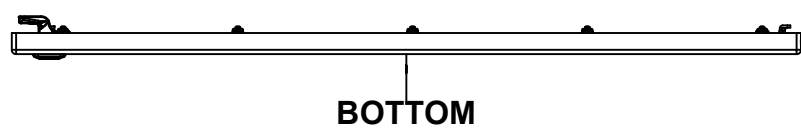
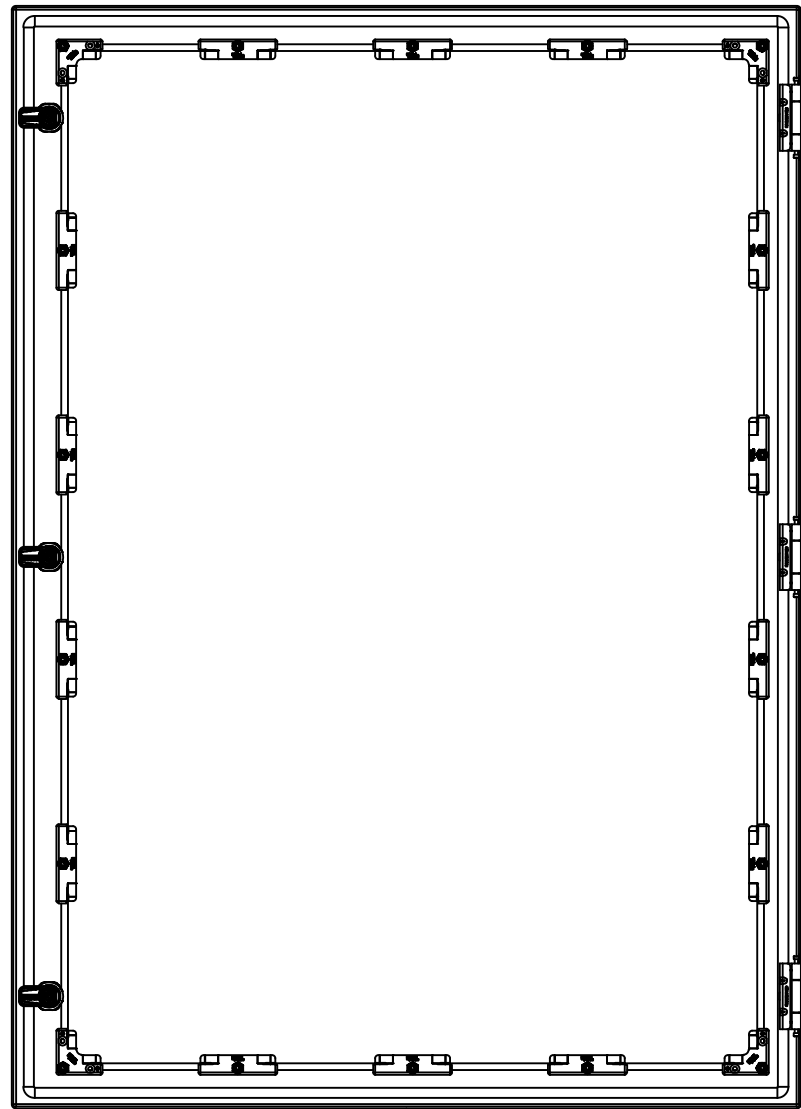
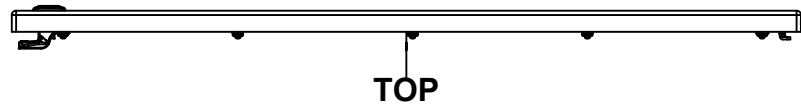

No.	Revisions	Date	By/Par

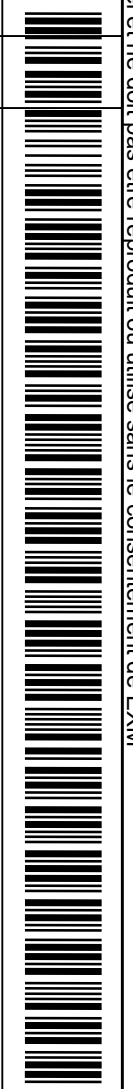
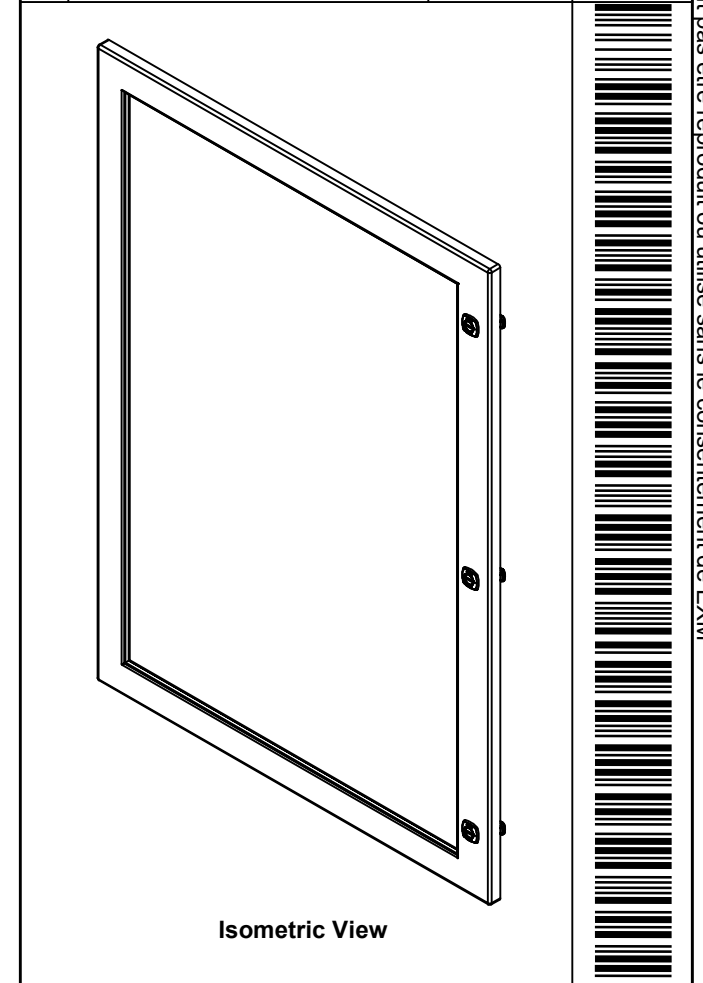

		Flatness Aplatissement Max 5.0mm Projection	
		Tél: (450) 979-4373 Fax: (450) 979-4626 www.exmweb.com	
Customer Client		Date	
Drawn By / Dessiné Par: BoxCad: BoxCad		Date: 07-Jun-23	
Material / Matière: 14 Ga Stainless Steel 316 (1.7mm)			
Color / Couleur: Unpainted		Finish / Fini: Brushed	
Description: 5412ESSW 42" x 30" Cover			Detail Rev.
Part Number / Numéro Pièce			Rev. 8

This drawing is confidential and must not be reproduced or used without the consent of EXM

Ce dessin est confidentiel et ne doit pas être reproduit ou utilisé sans le consentement de EXM

STANDARD FEATURES ARE NOT LISTED IN THIS HOLE TABLE

HOLE TABLE - FRONT VIEW (CUSTOM FEATURE ONLY)

CUT-OUT	XDIM	YDIM	DESCRIPTION
1	1.469	9.277	STUD M6 x 18mm (Inside)
2	27.968	9.277	STUD M6 x 18mm (Inside)
3	1.469	17.027	STUD M6 x 18mm (Inside)
4	27.968	17.027	STUD M6 x 18mm (Inside)
5	1.469	24.776	STUD M6 x 18mm (Inside)
6	27.968	24.776	STUD M6 x 18mm (Inside)
7	1.469	32.526	STUD M6 x 18mm (Inside)
8	27.968	32.526	STUD M6 x 18mm (Inside)
9	1.469	40.276	STUD M6 x 18mm (Inside)
10	1.469	1.527	STUD M6 x 18mm (Inside)
11	8.094	40.276	STUD M6 x 18mm (Inside)
12	8.094	1.527	STUD M6 x 18mm (Inside)
13	14.719	40.276	STUD M6 x 18mm (Inside)
14	14.719	1.527	STUD M6 x 18mm (Inside)
15	21.343	40.276	STUD M6 x 18mm (Inside)
16	21.343	1.527	STUD M6 x 18mm (Inside)
17	27.968	40.276	STUD M6 x 18mm (Inside)
18	27.968	1.527	STUD M6 x 18mm (Inside)

19	28.494	37.553	880 SCQ4-SLSS6
20	28.494	20.902	880 SCQ4-SLSS6
21	28.494	4.250	880 SCQ4-SLSS6

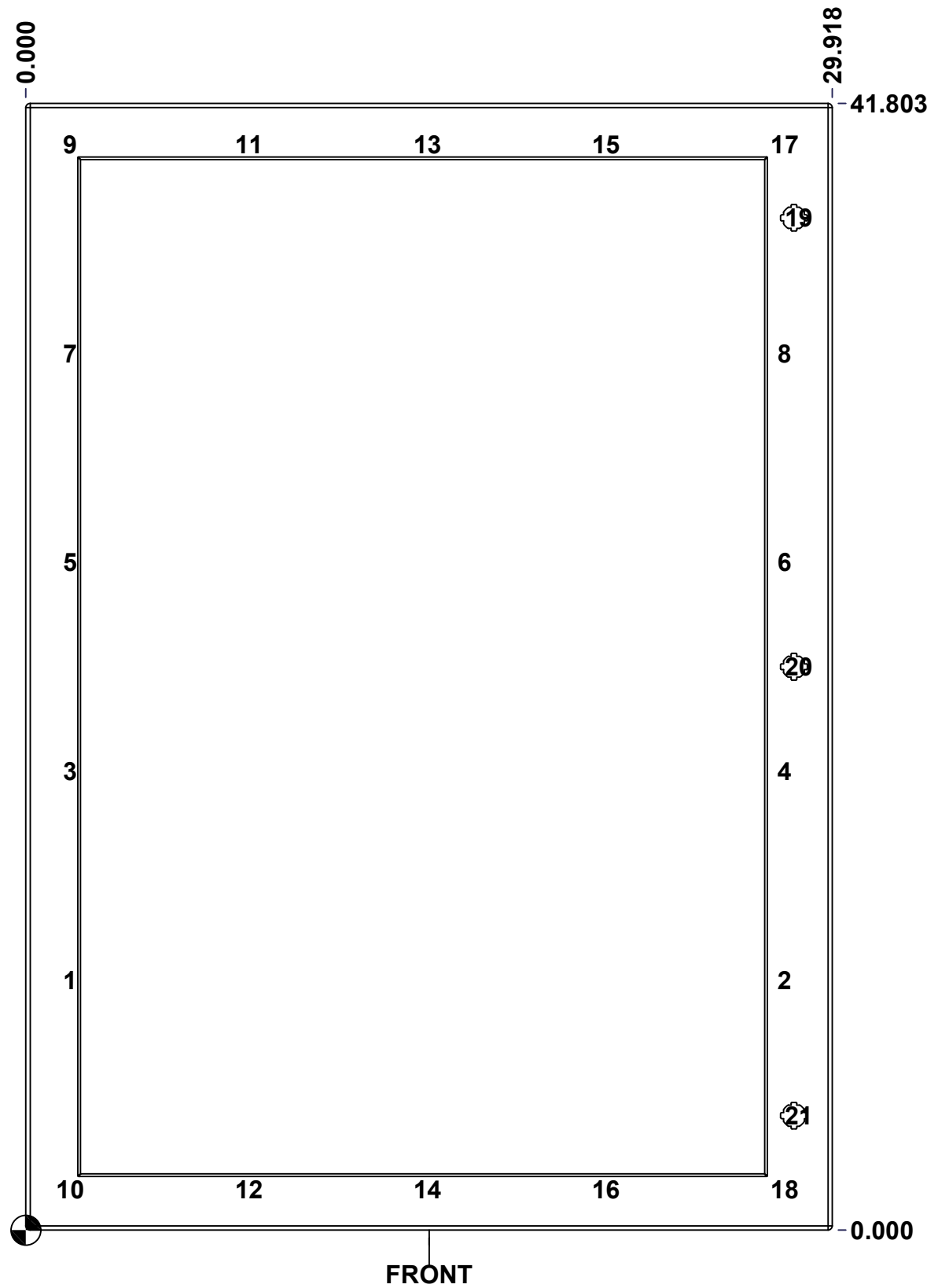

	Description	Status
	5412ESSW 42" x 30" Cover	(NULL)
	Part Number	Rev.
	Numéro Pièce	9
	5412ESSW4230086THNOIPC 0	15

This drawing is confidential and must not be reproduced or used without the consent of EXM

Ce dessin est confidentiel et ne doit pas être reproduit ou utilisé sans le consentement de EXM

No.	Revisions	Date	By/Par

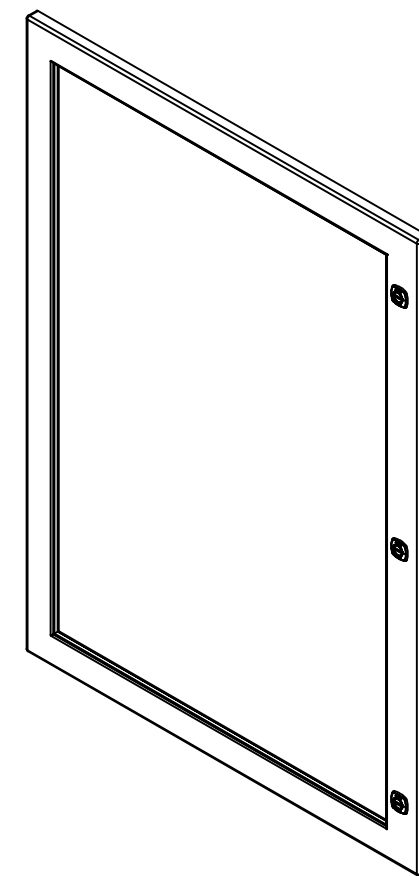

Isometric View



14	STK-Q-60701	2.1	880 WK - Lexan 1/4" Fixing Bracket
1	STK-A-60703	0	5412 ESW Lexan Bracket Kit
18	STK-Q-16053	1	Stud M6 x 23mm Stainless steel
1	STK-G-02710	0	880 HWKG - Windows Kit Gasket
1	5412ESSW4230086THNO IPLXG	0	5412ESSW 42" x 30" Lexan Gasket Part
1	5412ESSW4230086THNO IPLX	0	5412ESSW 38.375" x 26.125" Lexan Part
1	5412ESSW4230086THNO IPG	0	5412ESSW 42" x 30" Cover Gasket Part
1	5412ESSW4230086THNO IPC-P	0	5412ESSW 42" x 30" Cover Part
3	880 SCQ4-SLSS6	7	5412 ESS 1/4 Turn Lock
3	STK-A-33016	0	5412 ESS Bended Hinge (Body Part)
QTY	Part Number	Rev	Description

Parts List

	Flatness Aplatissement Max 5.0mm
	Projection
Tél: (450) 979-4373 Fax: (450) 979-4626 www.exmweb.com	Customer Client
Drawn By Dessiné Par BoxCad: BoxCad	Date 07-Jun-23
Material Matière 14 Ga Stainless Steel 316 (1.7mm)	Color Couleur Unpainted
Description 5412ESSW 42" x 30" Cover	Finish Fini Brushed
Part Number Numéro Pièce 5412ESSW4230086THNOIPC 0	Rev. 10

5412ESSW4230086THNOIPC 0

This drawing is confidential and must not be reproduced or used without the consent of EXM

Ce dessin est confidentiel et ne doit pas être reproduit ou utilisé sans le consentement de EXM

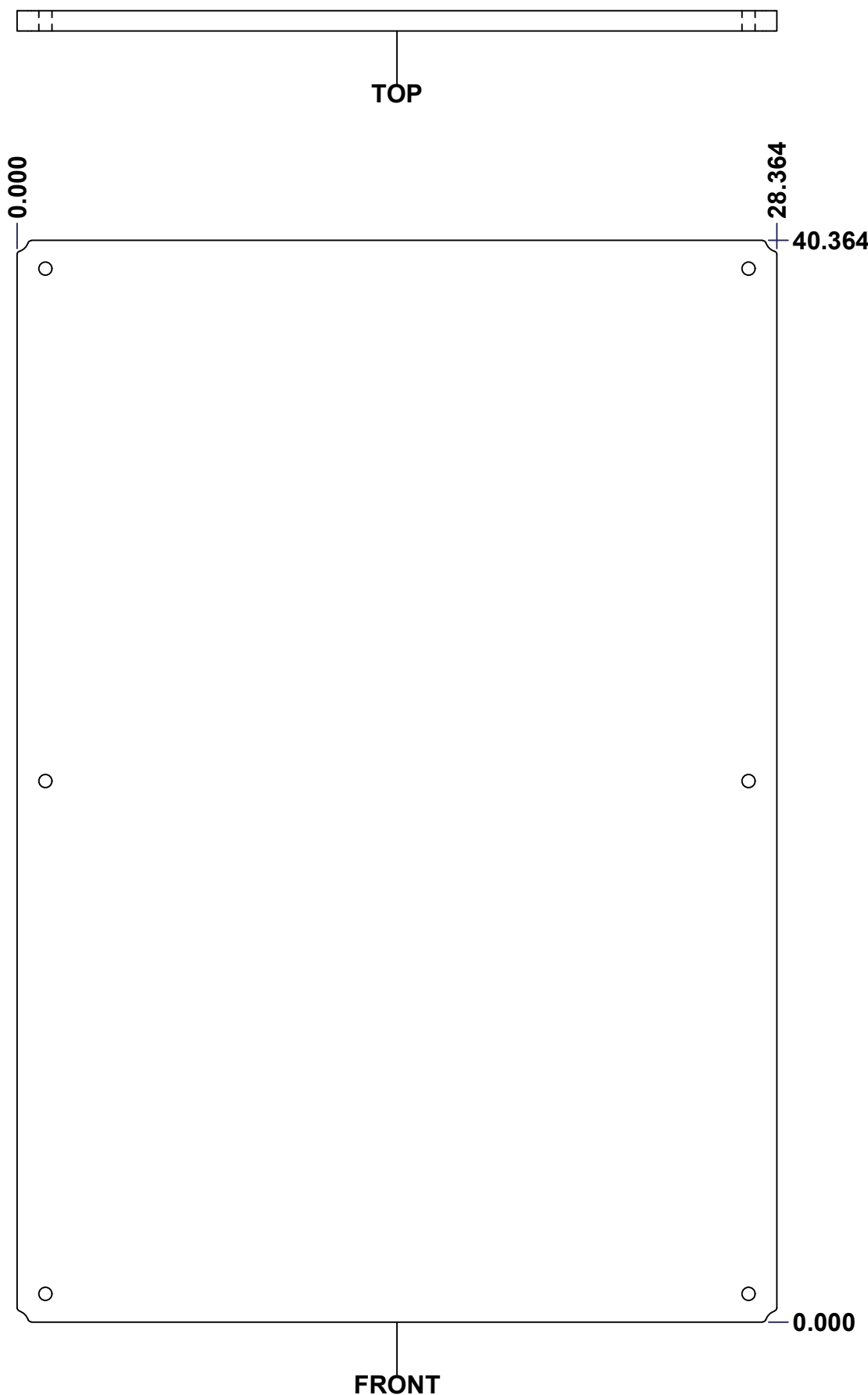

No.	Revisions	Date	By/Par

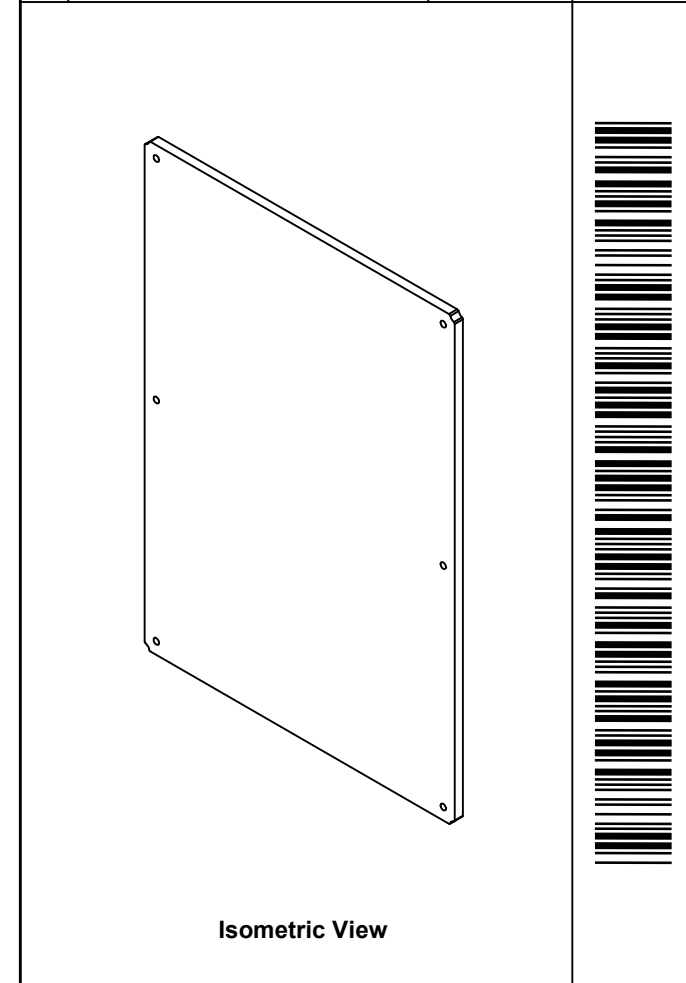

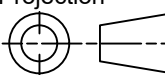
 Tél: (450) 979-4373 Fax: (450) 979-4626 www.exmweb.com		Flatness Aplatissement Max 3.0mm
Customer Client		Projection 
Drawn By / Dessiné Par: BoxCad: Patrick Deschenes		Date: 23-Jan-07
Material / Matière: Polyisocyanurate		
Color / Couleur: Aluminum	Finish / Fini: N/A	
Description: 5412ESSW 42" x 30" Back Insulation		Detail Rev.
Part Number / Numéro Pièce: 5412ESSW4230086THNOIP-B 0		Rev. 11

SEE BILL OF MATERIAL ON LAST PAGE 5412ESSW4230086THNOIP-B 0 15

This drawing is confidential and must not be reproduced or used without the consent of EXM

Ce dessin est confidentiel et ne doit pas être reproduit ou utilisé sans le consentement de EXM

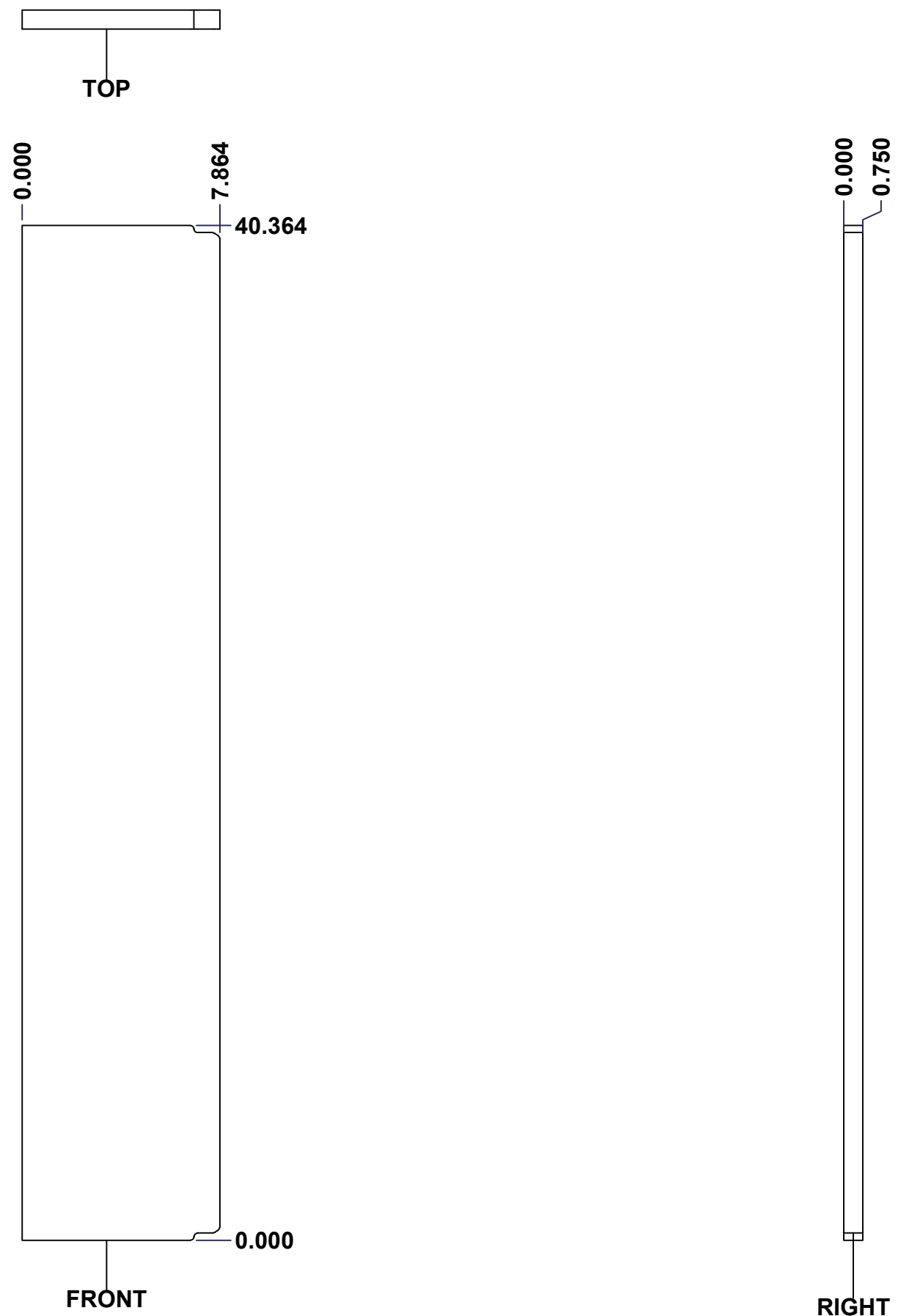

No.	Revisions	Date	By/Par

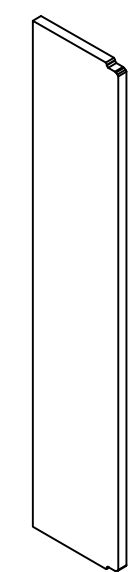

Isometric View

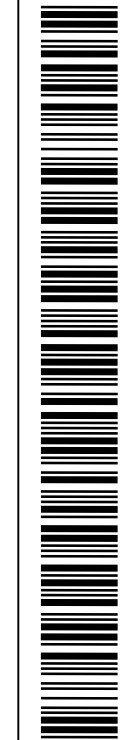

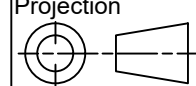
 Tél: (450) 979-4373 Fax: (450) 979-4626 www.exmweb.com		Flatness Aplatissement Max 3.0mm
Projection 		Date 23-Jan-07
Customer Client	Date	
Drawn By Dessiné Par	BoxCad: Patrick Deschenes	Date 23-Jan-07
Material Matière	Polyisocyanurate	
Color Couleur	Aluminum	Finish Fini N/A
Description	Detail Rev.	
5412ESSW 42" x 30" Left Insulation		
Part Number Numéro Pièce	Rev.	12
5412ESSW4230086THNOIP-L	S0	15

SEE BILL OF MATERIAL ON LAST PAGE

This drawing is confidential and must not be reproduced or used without the consent of EXM

Ce dessin est confidentiel et ne doit pas être reproduit ou utilisé sans le consentement de EXM

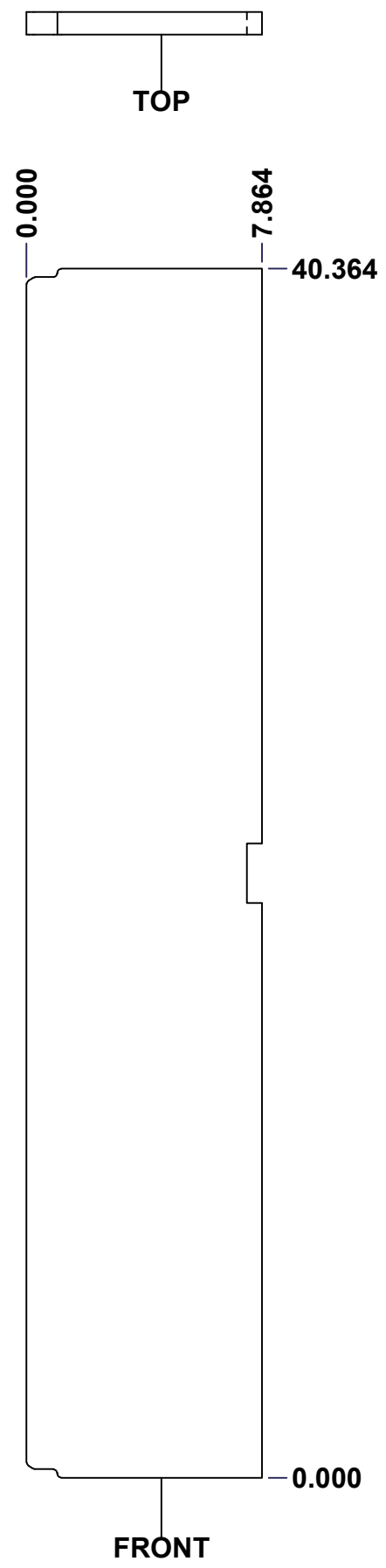

No.	Revisions	Date	By/Par

Isometric View

Tél: (450) 979-4373 Fax: (450) 979-4626 www.exmweb.com		Flatness Aplatissement Max 3.0mm
Customer Client		Projection
Drawn By / Dessiné Par: BoxCad: Patrick Deschenes		Date: 23-Jan-07
Material / Matière: Polyisocyanurate		
Color / Couleur: Aluminum	Finish / Fini: N/A	
Description: 5412ESSW 42" x 30" Right Insulation		Detail Rev.
Part Number / Numéro Pièce: 5412ESSW4230086THNOIP-RS0		Rev. 13

SEE BILL OF MATERIAL ON LAST PAGE

This drawing is confidential and must not be reproduced or used without the consent of EXM

Ce dessin est confidentiel et ne doit pas être reproduit ou utilisé sans le consentement de EXM



TOP

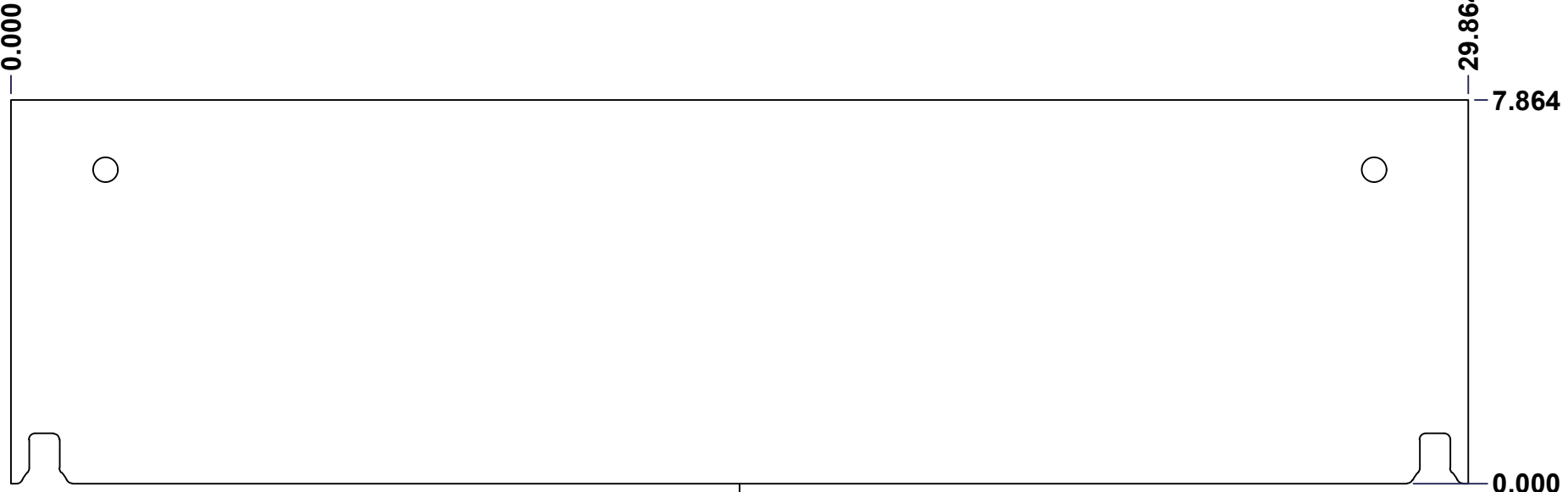

FRONT



RIGHT

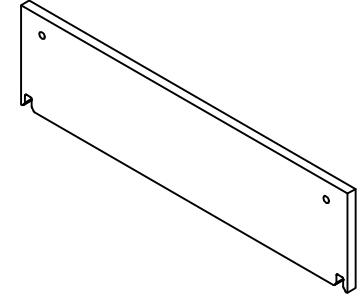

Isometric View



Tél: (450) 979-4373
 Fax: (450) 979-4626
www.exmweb.com

Flatness
 Aplatissement
 Max 3.0mm
 Projection

Customer Client	Date
Drawn By / Dessiné Par: BoxCad: Patrick Deschenes	Date: 23-Jan-07
Material / Matière: Polyisocyanurate	
Color / Couleur: Aluminum	Finish / Fini: N/A
Description: 5412ESSW 42" x 30" Top and Bottom Insulation	Detail Rev.

Part Number / Numéro Pièce: 5412ESSW4230086THNOIPI-TP0	Rev. 14
--	---------

SEE BILL OF MATERIAL ON LAST PAGE

This drawing is confidential and must not be reproduced or used without the consent of EXM

Ce dessin est confidentiel et ne doit pas être reproduit ou utilisé sans le consentement de EXM



TOP

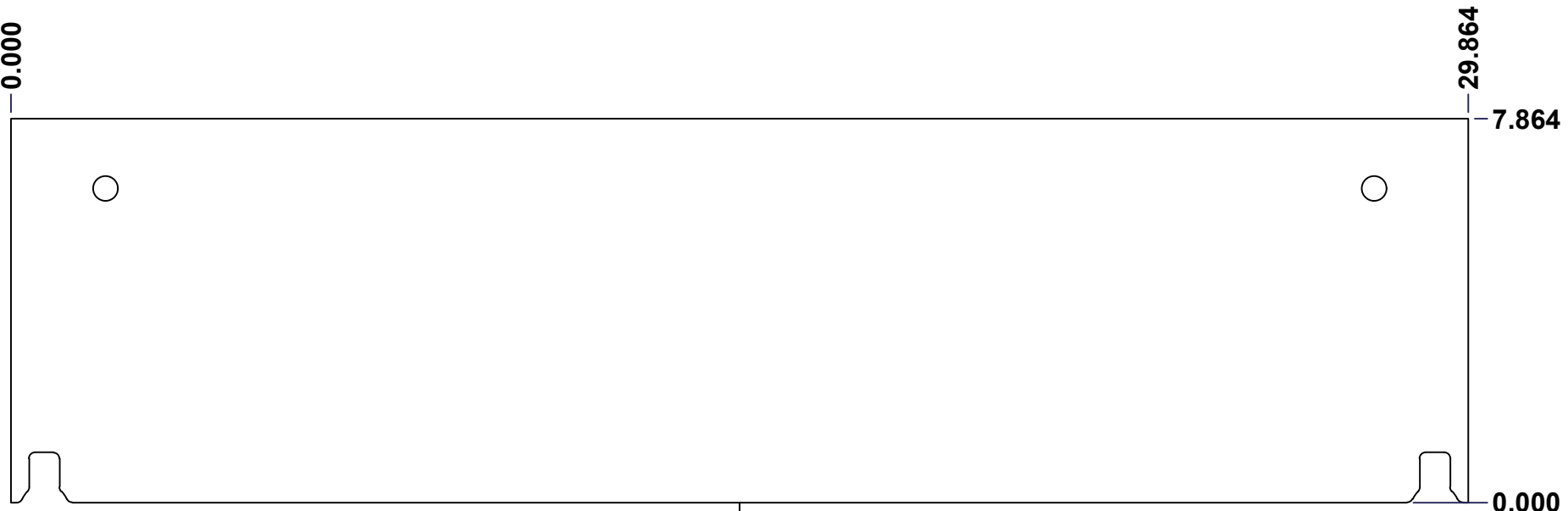

FRONT

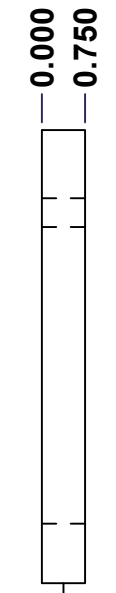

RIGHT

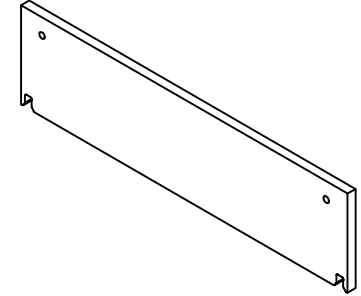

Isometric View



Tél: (450) 979-4373
 Fax: (450) 979-4626
www.exmweb.com

Flatness
 Aplatissement
 Max 3.0mm
 Projection

Customer Client	Date
Drawn By / Dessiné Par: BoxCad: Patrick Deschenes	Date: 23-Jan-07
Material / Matière: Polyisocyanurate	
Color / Couleur: Aluminum	Finish / Fini: N/A

Description: 5412ESSW 42" x 30" Top and Bottom Insulation

Detail Rev.

Part Number / Numéro Pièce	Rev.	15
----------------------------	------	----

SEE BILL OF MATERIAL ON LAST PAGE 5412ESSW4230086THNOIPI-BT0