

This drawing is confidential and must not be reproduced or used without the consent of EXM

Ce dessin est confidentiel et ne doit pas être reproduit ou utilisé sans le consentement de EXM

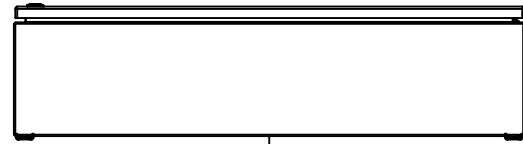

TOP

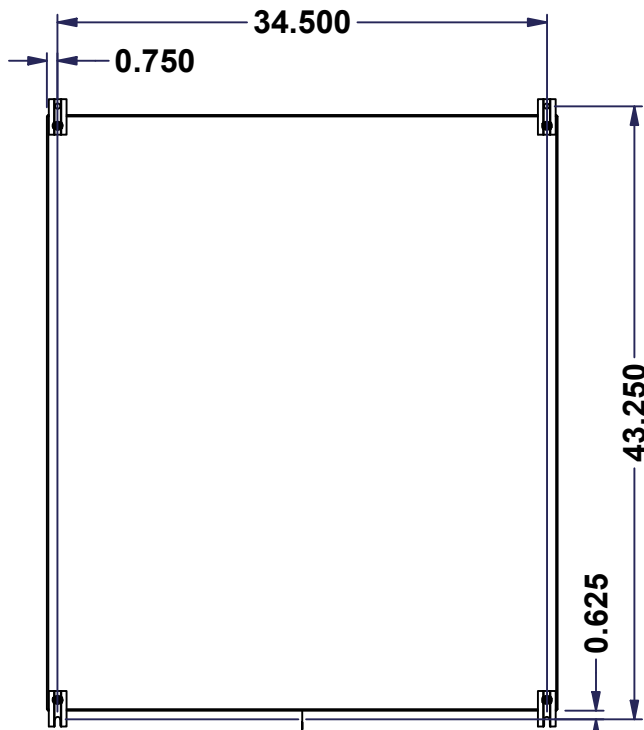

BACK

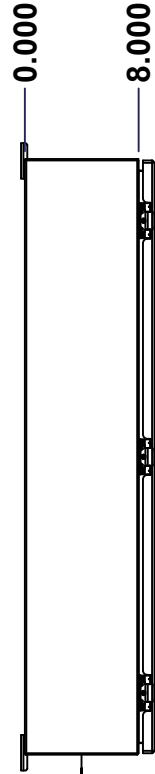

LEFT

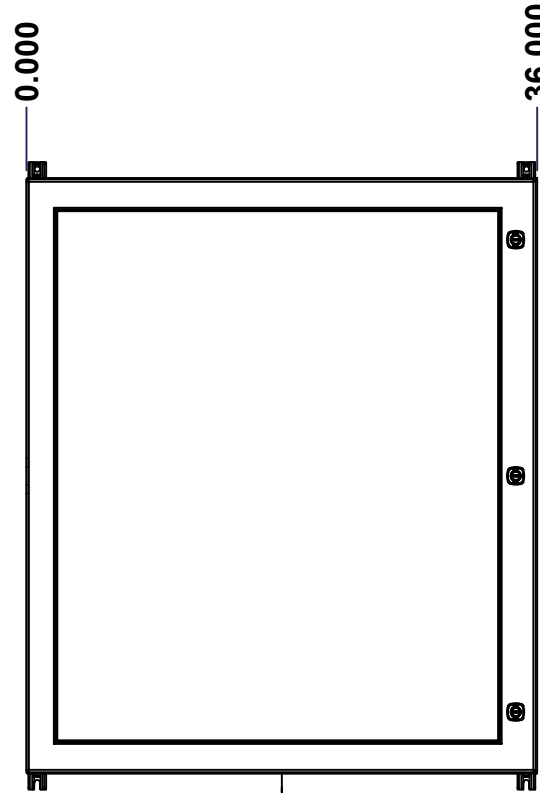

FRONT

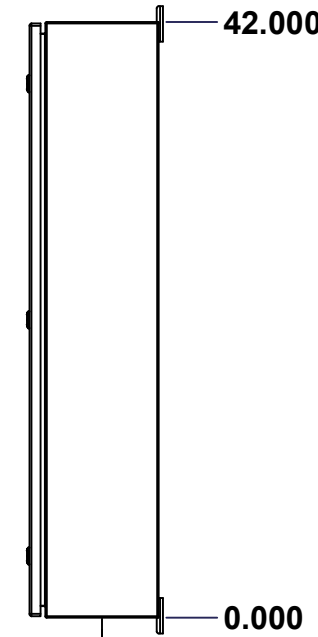

RIGHT

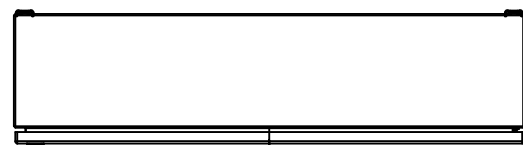

BOTTOM

No.	Revisions	Date	By/Par

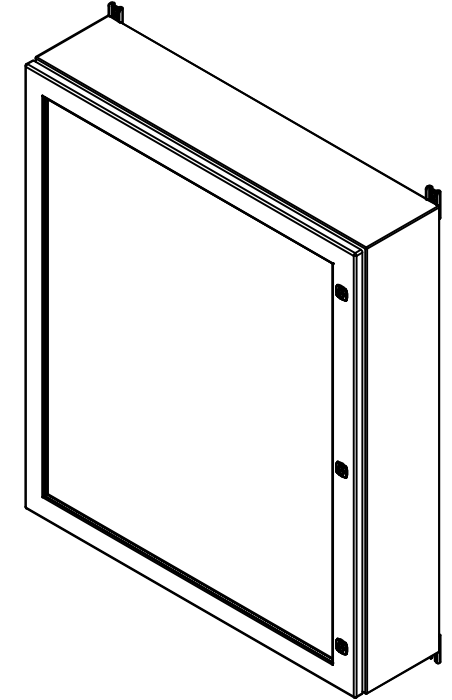

Isometric View



**GRAIN DIRECTION:
TOP/BOTTOM: HORIZONTAL
LEFT/RIGHT/BACK/FRONT: VERTICAL**

	Flatness Aplatissement Max 3.0mm
	Projection
Tél: (450) 979-4373 Fax: (450) 979-4626 www.exmweb.com	Customer Client Date
Drawn By Dessiné Par: BoxCad: BoxCad	Date: 07-Jun-23
Material Matière: 14 Ga Stainless Steel 316 (1.7mm)	Color Couleur: Unpainted
Description 5412ESSW 42" x 36" x 8" Assembly	Finish Fini: Brushed
Part Number Numéro Pièce: 5412ESSW4236086TH	Detail Rev. Rev.: 1
SEE BILL OF MATERIAL ON LAST PAGE	Rev.: 0

This drawing is confidential and must not be reproduced or used without the consent of EXM

Ce dessin est confidentiel et ne doit pas être reproduit ou utilisé sans le consentement de EXM

NOTE	
ITEM	DESCRIPTION
1	NEMA 4X Enclosure
2	C/W Standard ground studs on box and cover
3	W/O Standard door stiffener
4	C/W Standard inner panel (Included)
5	C/W Standard inner panel mounting studs
6	C/W 885 ESMF4_OPEN Sold separately (Installed)
7	C/W 885 ESMF4_CLOSE Sold separately (Installed)
8	C/W R5 Insulation (Installed by EXM)

No.	Revisions	Date	By/Par

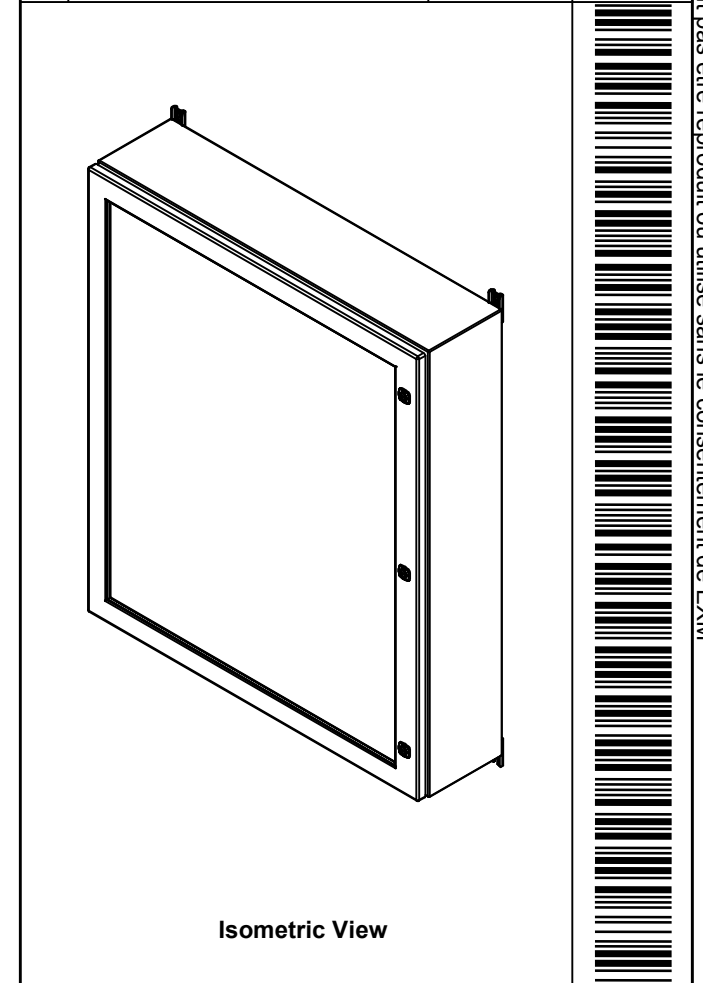

Tél: (450) 979-4373
Fax: (450) 979-4626
www.exmweb.com

Flatness
Aplatissement
Max 3.0mm

Projection

PACKING		
ITEM	QTY	DESCRIPTION
Cardboard sleeve	2	Top and Bottom
Cardboard strip	2	Between back of enclosure and inner panel
Plastic bag	1	To protect cover surface and inside gasket
Cardboard corner	4	To reinforced for the plastic strap tightening
Plastic strap - Black	2	To Squeeze the 2 cardboard sleeve together
Packaging label	3	White label with PN
Plastic strap- Green	2	To secure the enclosure to the wood pallet
Wood Pallet	1	2" deeper and 3" larger than enclosure size

8	STK-Q-00600	2	M12 to M8 Adaptor
1	881 SP4236G	0	881 SP - Inner Panel
1	STK-K-01800	5	5412 ES Accessory Kit
1	5412ESSW4236086THC	0	5412ESSW 42" x 36" Cover
1	5412ESSW4236086THB	0	5412ESSW 42" x 36" x 8" Body
3	STK-Q-04051-08	1	M6 x 8mm Stainless Steel Hexagon Socket Head Machine Screw with Nyseal
Qty	Part Number	Rev	Description
Parts List			

Customer Client	Date
Drawn By Dessiné Par	BoxCad: BoxCad Date 07-Jun-23
Material Matière	14 Ga Stainless Steel 316 (1.7mm)
Color Couleur	Unpainted Finish Brushed
Description	Detail Rev.
5412ESSW 42" x 36" x 8" Assembly	
Part Number Numéro Pièce	Rev. 2
5412ESSW4236086TH	0
	15

This drawing is confidential and must not be reproduced or used without the consent of EXM

Ce dessin est confidentiel et ne doit pas être reproduit ou utilisé sans le consentement de EXM

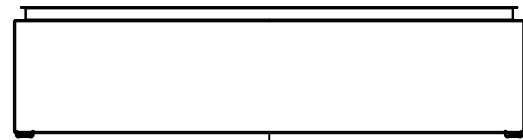

TOP

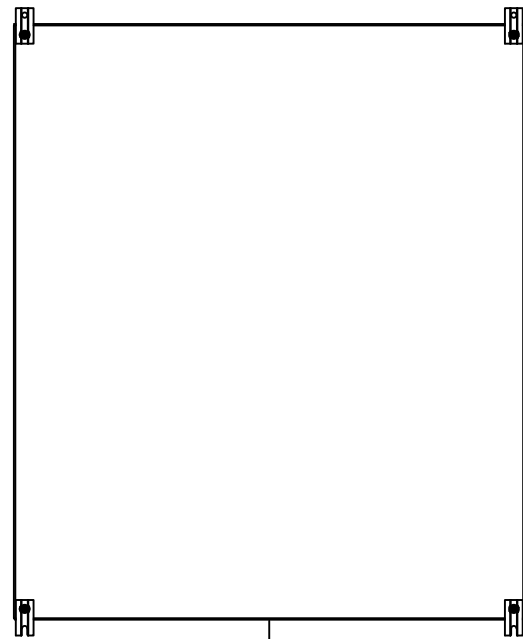

BACK

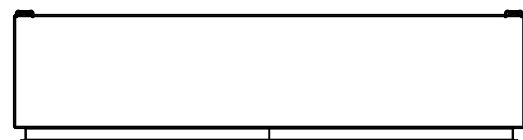

BOTTOM

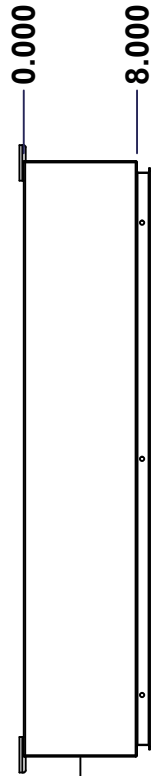

LEFT

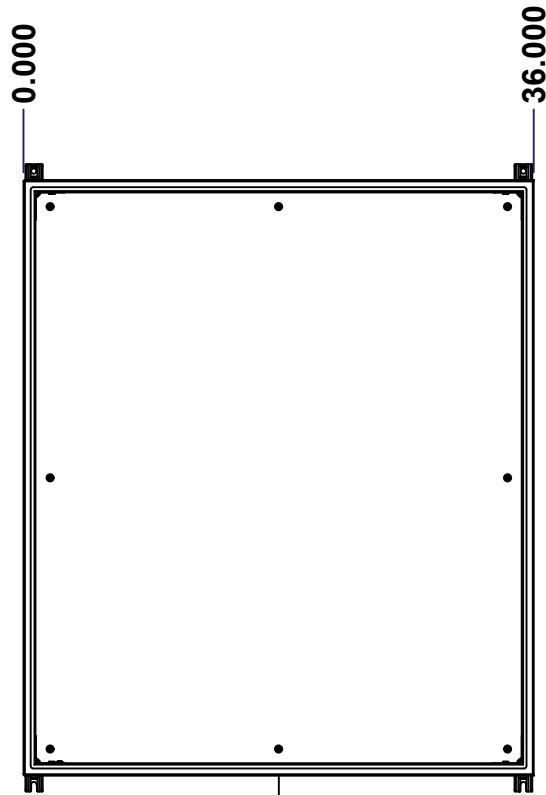

FRONT

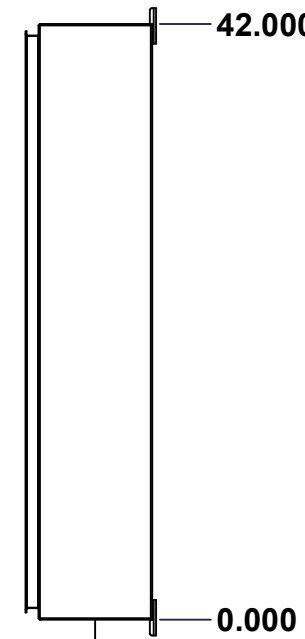

RIGHT

No.	Revisions	Date	By/Par

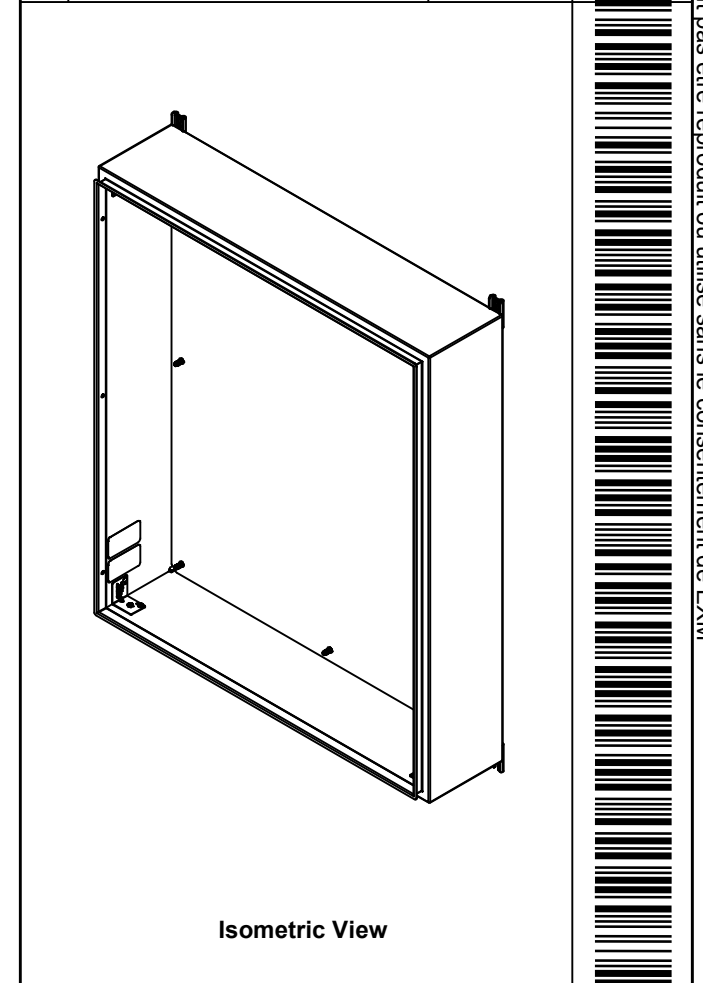

Isometric View



 Tél: (450) 979-4373 Fax: (450) 979-4626 www.exmweb.com		Flatness Aplatissement Max 3.0mm
Customer Client		Date
Drawn By / Dessiné Par: BoxCad: BoxCad		Date: 07-Jun-23
Material / Matière: 14 Ga Stainless Steel 316 (1.7mm)		
Color / Couleur: Unpainted	Finish / Fini: Brushed	
Description: 5412ESSW 42" x 36" x 8" Body		Detail Rev.
Part Number / Numéro Pièce: 5412ESSW4236086THB		Rev. 3 0

SEE BILL OF MATERIAL ON LAST PAGE

This drawing is confidential and must not be reproduced or used without the consent of EXM

Ce dessin est confidentiel et ne doit pas être reproduit ou utilisé sans le consentement de EXM

STANDARD FEATURES ARE NOT LISTED IN THIS HOLE TABLE			
HOLE TABLE - TOP VIEW (CUSTOM FEATURE ONLY)			
CUT-OUT	XDIM	YDIM	DESCRIPTION
1	2.000	6.500	INSUL. STUD M6 x 18mm (Inside)
2	34.000	6.500	INSUL. STUD M6 x 18mm (Inside)

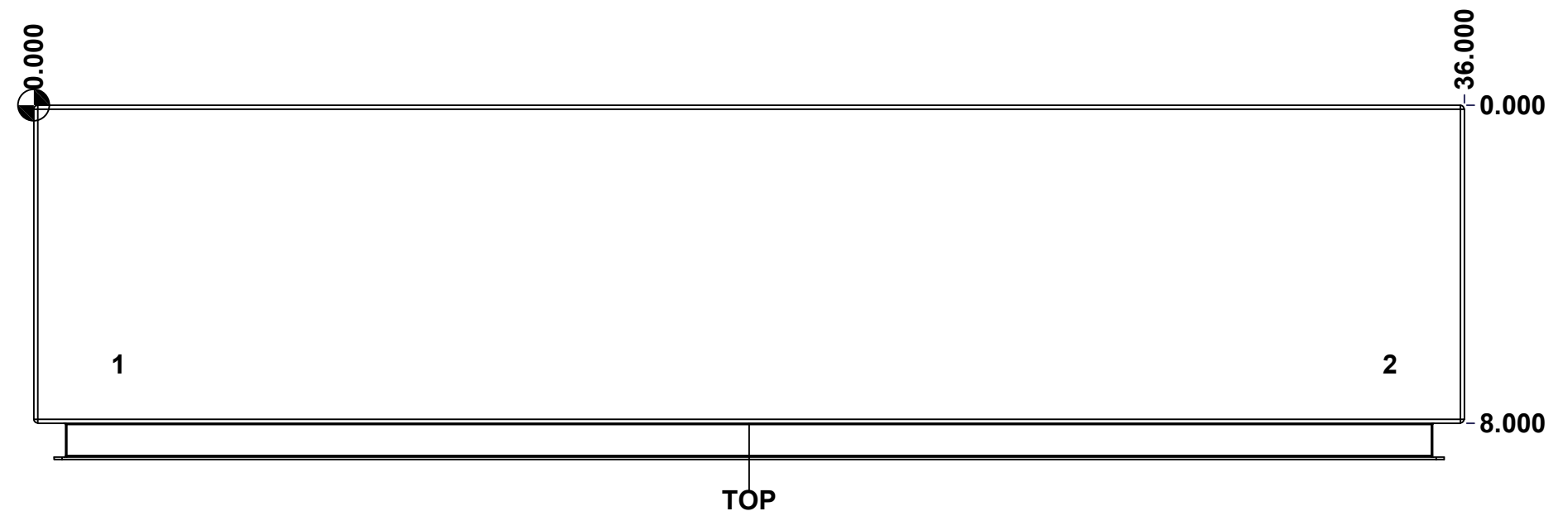

	Description	Status
	5412ESSW 42" x 36" x 8" Body	(NULL)
	Part Number Numéro Pièce	Rev.
	5412ESSW4236086THB	0
		4
		15

This drawing is confidential and must not be reproduced or used without the consent of EXM

Ce dessin est confidentiel et ne doit pas être reproduit ou utilisé sans le consentement de EXM

STANDARD FEATURES ARE NOT LISTED IN THIS HOLE TABLE			
HOLE TABLE - BOTTOM VIEW (CUSTOM FEATURE ONLY)			
CUT-OUT	XDIM	YDIM	DESCRIPTION
1	2.000	6.500	INSUL. STUD M6 x 18mm (Inside)
2	34.000	6.500	INSUL. STUD M6 x 18mm (Inside)

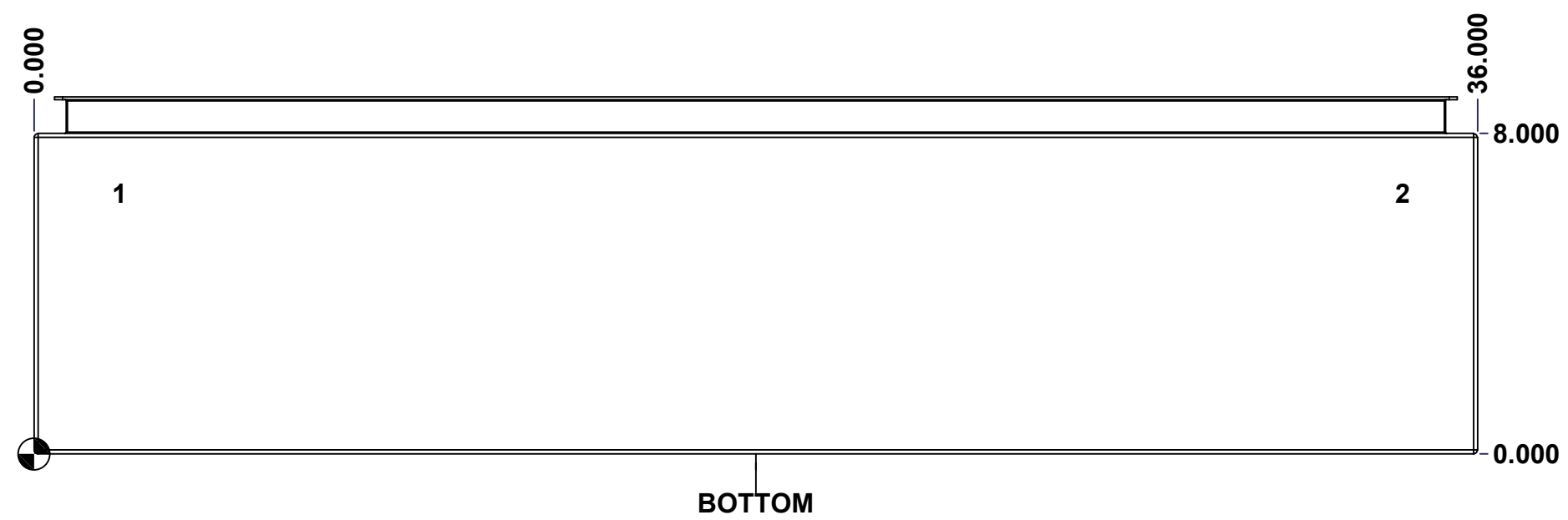

	Description	Status
	5412ESSW 42" x 36" x 8" Body	(NULL)
	Part Number Numéro Pièce	Rev.
	5412ESSW4236086THB	0 / 5
		15

This drawing is confidential and must not be reproduced or used without the consent of EXM

Ce dessin est confidentiel et ne doit pas être reproduit ou utilisé sans le consentement de EXM

STANDARD FEATURES ARE NOT LISTED IN THIS HOLE TABLE

HOLE TABLE - BACK VIEW (CUSTOM FEATURE ONLY)

CUT-OUT	XDIM	YDIM	DESCRIPTION
1	1.875	1.875	IP STUD M8 x 35mm (Inside)
2	1.875	40.125	IP STUD M8 x 35mm (Inside)
3	34.125	40.125	IP STUD M8 x 35mm (Inside)
4	34.125	1.875	IP STUD M8 x 35mm (Inside)
5	1.875	21.000	IP STUD M8 x 35mm (Inside)
6	34.125	21.000	IP STUD M8 x 35mm (Inside)
7	18.000	1.875	IP STUD M8 x 35mm (Inside)
8	18.000	40.125	IP STUD M8 x 35mm (Inside)

9	35.250	0.000	FOOT 885 ESMF4_OPEN
10	0.750	0.000	FOOT 885 ESMF4_OPEN
11	35.250	42.000	FOOT 885 ESMF4_CLOSE
12	0.750	42.000	FOOT 885 ESMF4_CLOSE

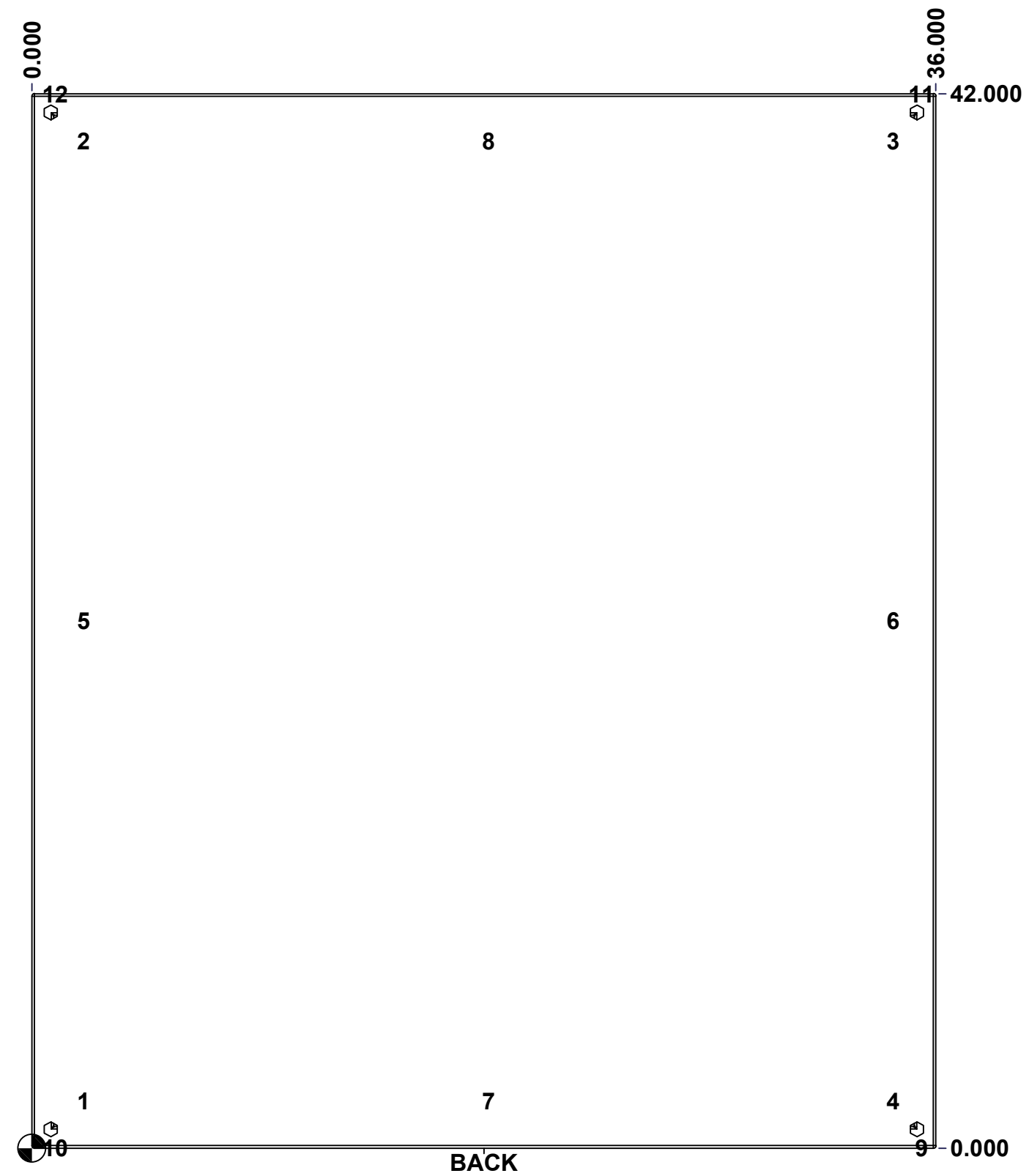

	Description	Status
	5412ESSW 42" x 36" x 8" Body	(NULL)
	Part Number Numéro Pièce	Rev.
	5412ESSW4236086THB	0 / 6
		15

This drawing is confidential and must not be reproduced or used without the consent of EXM

Ce dessin est confidentiel et ne doit pas être reproduit ou utilisé sans le consentement de EXM

No.	Revisions	Date	By/Par

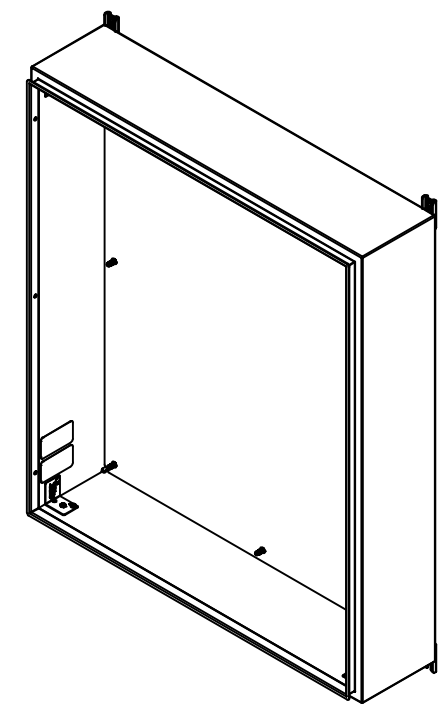

Isometric View



2	885ESMF4-FEET	0	885 ESMF4 Stainless Steel Mounting Foot
4	RIVET_NUT_SS_M10_FH_CE	0	Stainless Steel Rivet Nut M10 (Low Profile Close End)
4	STK-Q-06670	2	M10 x 16mm Stainless Steel Machine Screw
2	885ESMF4-FEET-A	0	885 ESMF4 Stainless Steel Mounting Foot (Opened Slot)
2	STK-S-00100	0	3.5" x 2" Silver Milar Flexcon Sticker
1	STK-K-70554	3	5412 ESTH Accessory Kit
1	5412ESSW4236086THI-RS	0	5412ESSW 42" x 36" Right Insulation
1	5412ESSW4236086THI-LS	0	5412ESSW 42" x 36" Left Insulation
1	5412ESSW4236086THI-BT	0	5412ESSW 42" x 36" Top and Bottom Insulation
1	5412ESSW4236086THI-TP	0	5412ESSW 42" x 36" Top and Bottom Insulation
1	5412ESSW4236086THI-B	0	5412ESSW 42" x 36" Back Insulation
4	STK-Q-16070	1	Stud M6 x 18mm Stainless steel
8	STK-Q-16020	1	Stud M8 x 35mm Stainless Steel
1	5412ESSW4236086THB-P	0	5412ESSW 42" x 36" x 8" Body Part
Qty	Part Number	Rev	Description
Parts List			

Tél: (450) 979-4373 Fax: (450) 979-4626 www.exmweb.com	Flatness Aplatissement
	Max 3.0mm
Projection	
Customer Client	Date
Drawn By Dessiné Par	Date 07-Jun-23
Material Matière	14 Ga Stainless Steel 316 (1.7mm)
Color Couleur	Unpainted
Finish Fini	Brushed
Description	Detail Rev.
5412ESSW 42" x 36" x 8" Body	
Part Number Numéro Pièce	Rev. 7
5412ESSW4236086THB	0

This drawing is confidential and must not be reproduced or used without the consent of EXM

Ce dessin est confidentiel et ne doit pas être reproduit ou utilisé sans le consentement de EXM

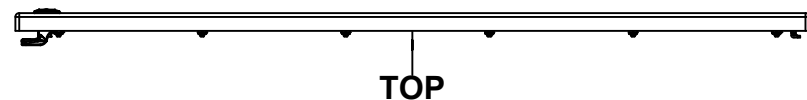

TOP

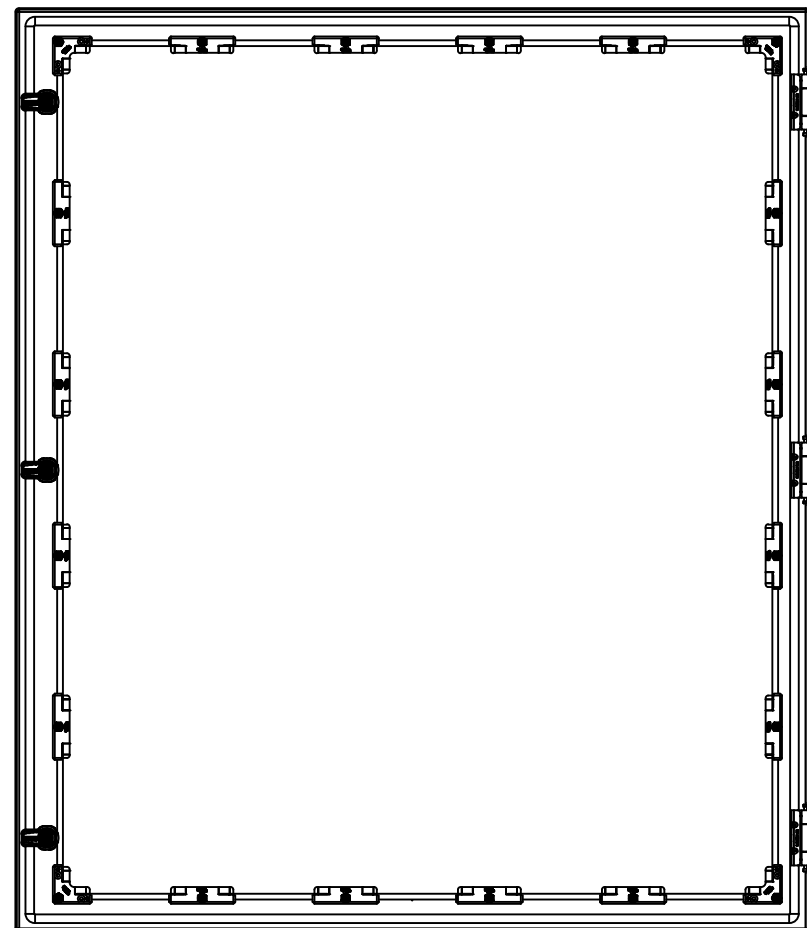

BACK

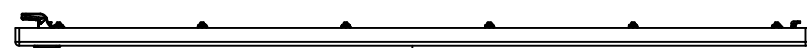

BOTTOM

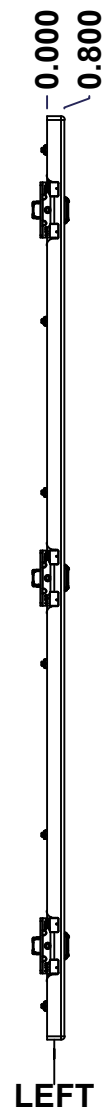

LEFT

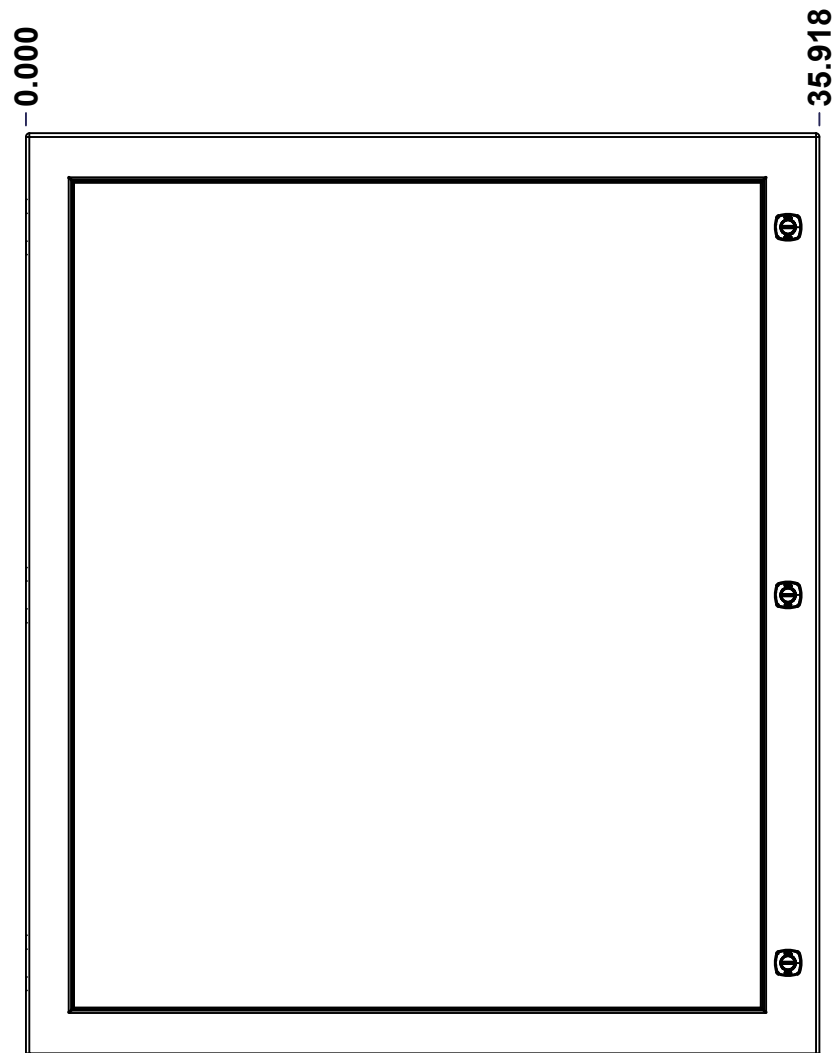

FRONT

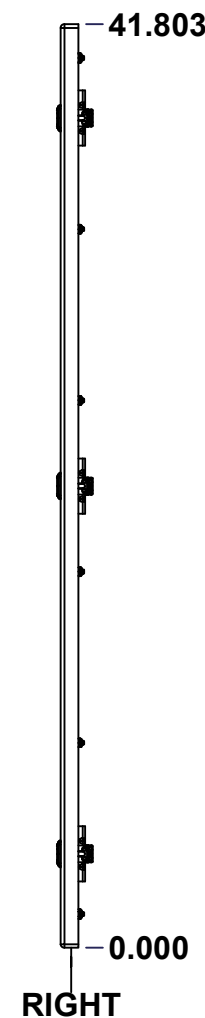

RIGHT

No.	Revisions	Date	By/Par

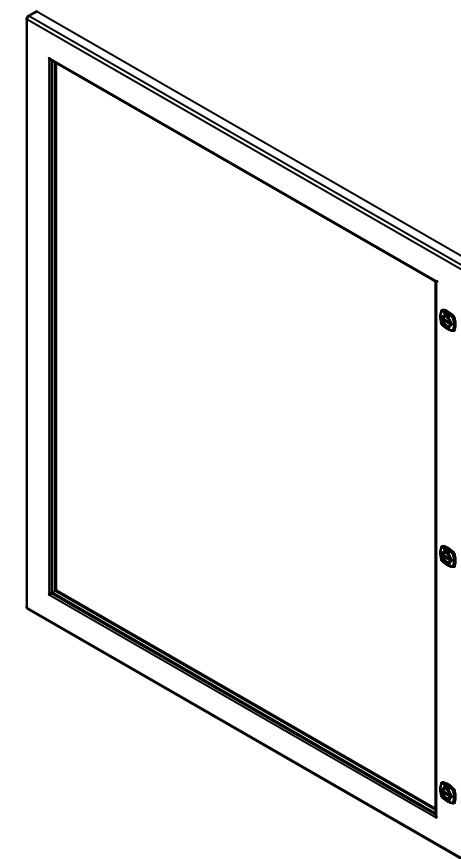

Isometric View



Tél: (450) 979-4373
 Fax: (450) 979-4626
www.exmweb.com

Flatness
Aplatissement
Max 3.0mm
Projection

Customer Client	Date
Drawn By Dessiné Par BoxCad: BoxCad	Date 07-Jun-23
Material Matière 14 Ga Stainless Steel 316 (1.7mm)	
Color Couleur Unpainted	Finish Fini Brushed
Description 5412ESSW 42" x 36" Cover	Detail Rev.
Part Number Numéro Pièce 5412ESSW4236086THC	Rev. 8
	0

SEE BILL OF MATERIAL ON LAST PAGE

This drawing is confidential and must not be reproduced or used without the consent of EXM

Ce dessin est confidentiel et ne doit pas être reproduit ou utilisé sans le consentement de EXM

STANDARD FEATURES ARE NOT LISTED IN THIS HOLE TABLE

HOLE TABLE - FRONT VIEW (CUSTOM FEATURE ONLY)

CUT-OUT	XDIM	YDIM	DESCRIPTION
1	1.469	9.277	STUD M6 x 18mm (Inside)
2	33.968	9.277	STUD M6 x 18mm (Inside)
3	1.469	17.027	STUD M6 x 18mm (Inside)
4	33.968	17.027	STUD M6 x 18mm (Inside)
5	1.469	24.776	STUD M6 x 18mm (Inside)
6	33.968	24.776	STUD M6 x 18mm (Inside)
7	1.469	32.526	STUD M6 x 18mm (Inside)
8	33.968	32.526	STUD M6 x 18mm (Inside)
9	1.469	40.276	STUD M6 x 18mm (Inside)
10	1.469	1.527	STUD M6 x 18mm (Inside)
11	7.969	40.276	STUD M6 x 18mm (Inside)
12	7.969	1.527	STUD M6 x 18mm (Inside)
13	14.469	40.276	STUD M6 x 18mm (Inside)
14	14.469	1.527	STUD M6 x 18mm (Inside)
15	20.968	40.276	STUD M6 x 18mm (Inside)
16	20.968	1.527	STUD M6 x 18mm (Inside)
17	27.468	40.276	STUD M6 x 18mm (Inside)
18	27.468	1.527	STUD M6 x 18mm (Inside)
19	33.968	40.276	STUD M6 x 18mm (Inside)
20	33.968	1.527	STUD M6 x 18mm (Inside)

21	34.494	37.553	880 SCQ4-SLSS6
22	34.494	20.902	880 SCQ4-SLSS6
23	34.494	4.250	880 SCQ4-SLSS6

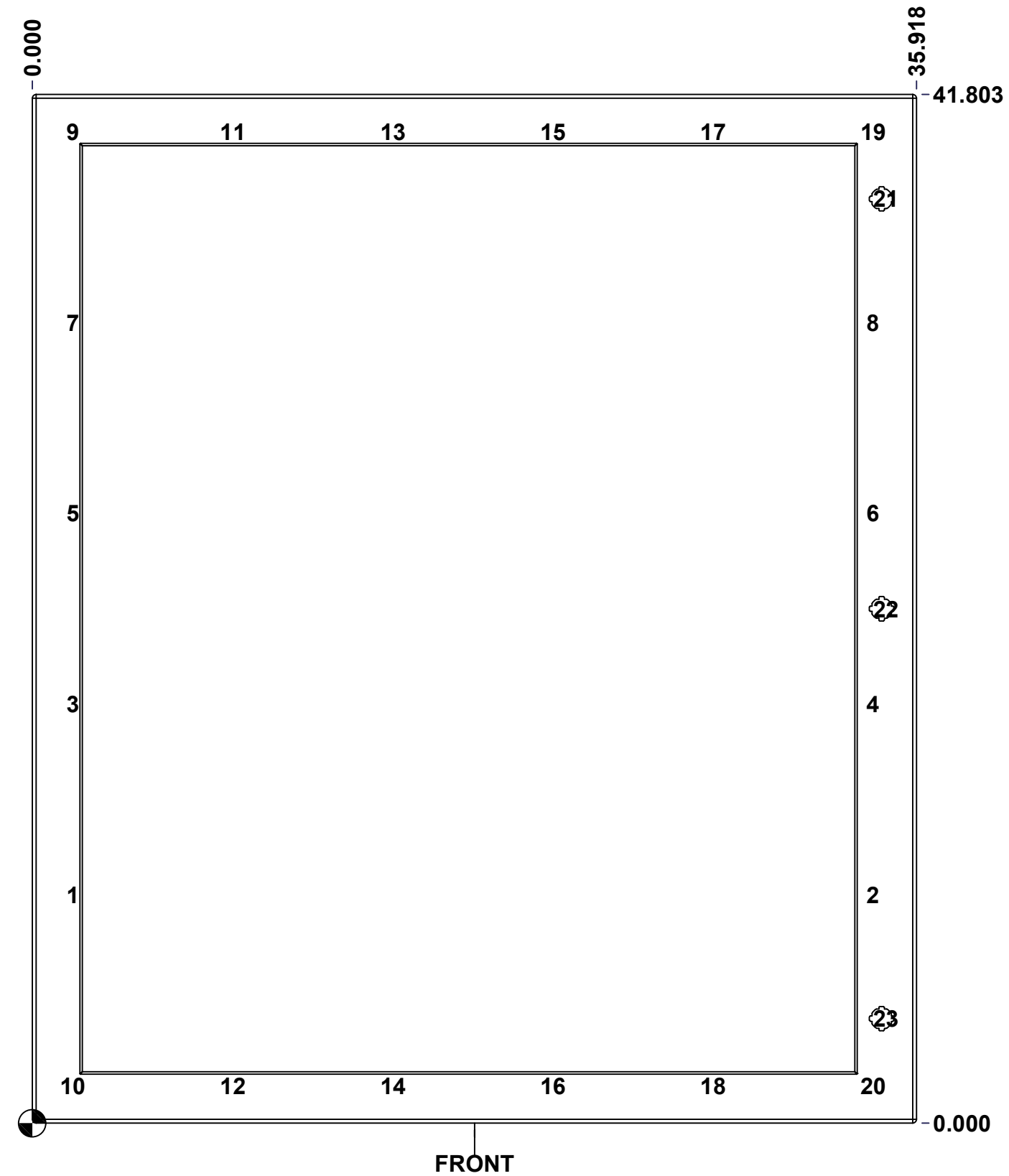

	Description	Status
	5412ESSW 42" x 36" Cover	(NULL)
	Part Number	Rev.
	Numéro Pièce 5412ESSW4236086THC	0
		9
		15

This drawing is confidential and must not be reproduced or used without the consent of EXM

Ce dessin est confidentiel et ne doit pas être reproduit ou utilisé sans le consentement de EXM

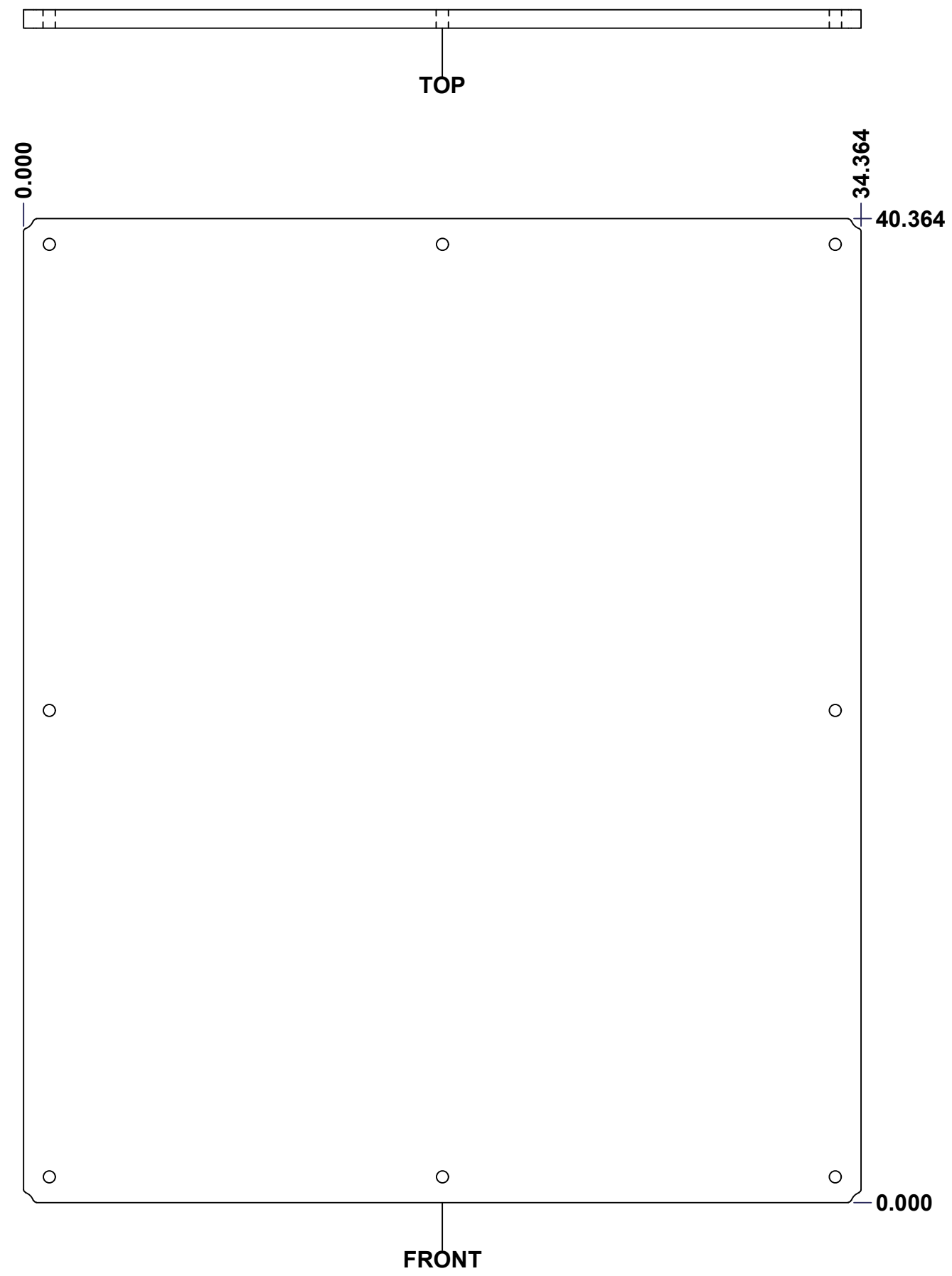

No.	Revisions	Date	By/Par

Isometric View

<p>Tél: (450) 979-4373 Fax: (450) 979-4626 www.exmweb.com</p>		Flatness Aplatissement	
		Max 3.0mm	
Customer Client		Date	
Drawn By Dessiné Par		Date	
Material Matière		Polyisocyanurate	
Color Couleur	Aluminum	Finish Fini	N/A
Description		Detail Rev.	
5412ESSW 42" x 36" Back Insulation			
Part Number Numéro Pièce		Rev.	11
5412ESSW4236086THI-B		0	15

SEE BILL OF MATERIAL ON LAST PAGE

This drawing is confidential and must not be reproduced or used without the consent of EXM

Ce dessin est confidentiel et ne doit pas être reproduit ou utilisé sans le consentement de EXM

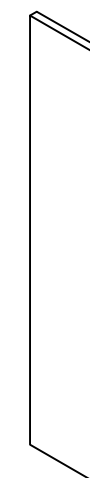
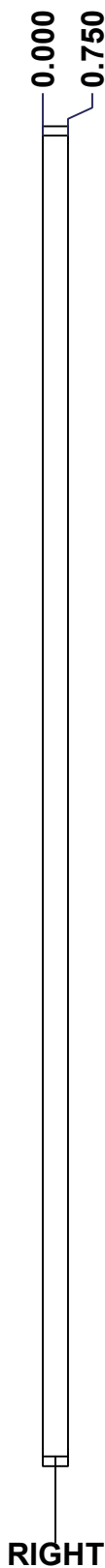
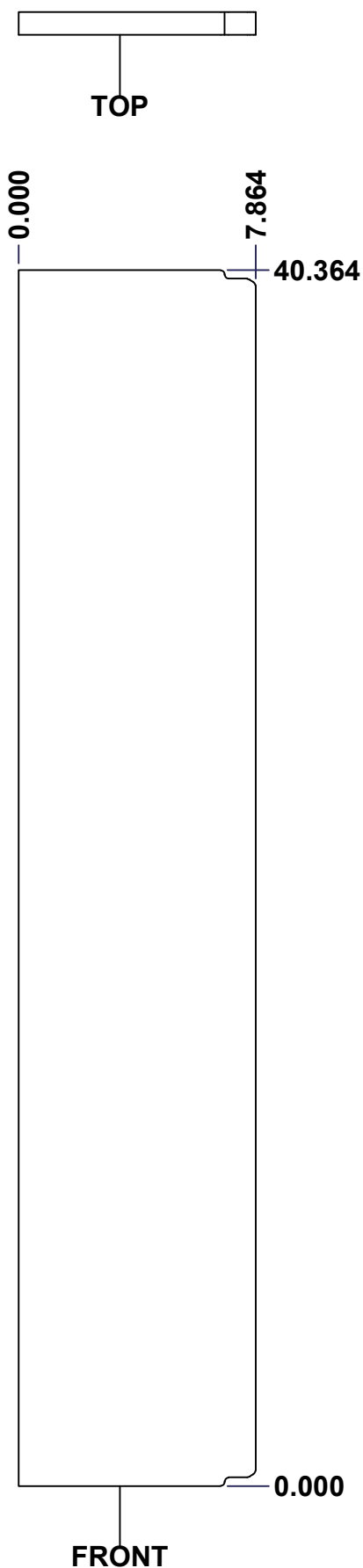

Isometric View

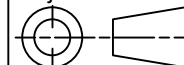

 Tél: (450) 979-4373 Fax: (450) 979-4626 www.exmweb.com		Flatness Aplatissement Max 3.0mm Projection 	
Customer Client		Date	
Drawn By Dessiné Par BoxCad: Patrick Deschenes		Date 23-Jan-07	
Material Matière Polyisocyanurate			
Color Couleur Aluminum		Finish Fini N/A	
Description 5412ESSW 42" x 36" Left Insulation			Detail Rev.
Part Number Numéro Pièce 5412ESSW4236086TH-LS		Rev. 0	12 / 15

SEE BILL OF MATERIAL ON LAST PAGE

This drawing is confidential and must not be reproduced or used without the consent of EXM

Ce dessin est confidentiel et ne doit pas être reproduit ou utilisé sans le consentement de EXM

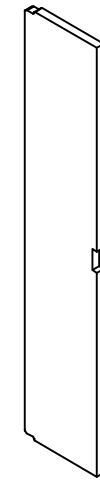
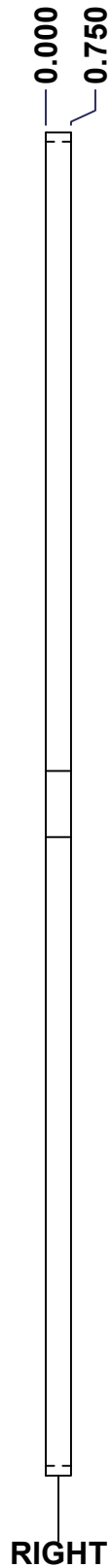
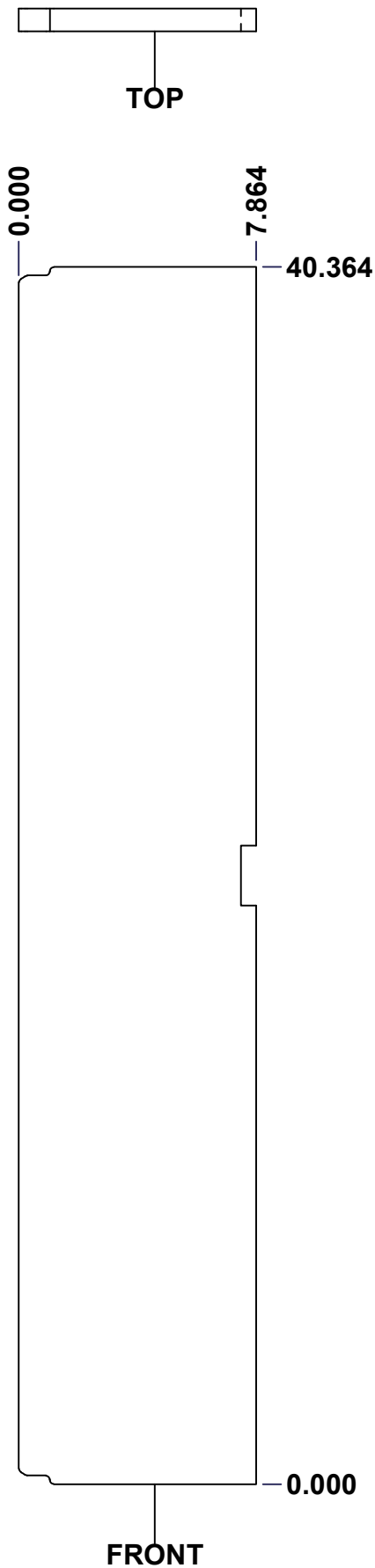

Isometric View



Tél: (450) 979-4373
 Fax: (450) 979-4626
www.exmweb.com

Flatness
Aplatissement

Max 3.0mm

Projection

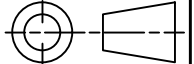

Customer Client	Date
Drawn By Dessiné Par	Date 23-Jan-07
Material Matière	Polyisocyanurate
Color Couleur	Aluminum
Finish Fini	N/A

Description	Detail Rev.
5412ESSW 42" x 36" Right Insulation	

Part Number Numéro Pièce	Rev.	13
5412ESSW4236086TH-RS	0	15

SEE BILL OF MATERIAL ON LAST PAGE

This drawing is confidential and must not be reproduced or used without the consent of EXM

Ce dessin est confidentiel et ne doit pas être reproduit ou utilisé sans le consentement de EXM



TOP

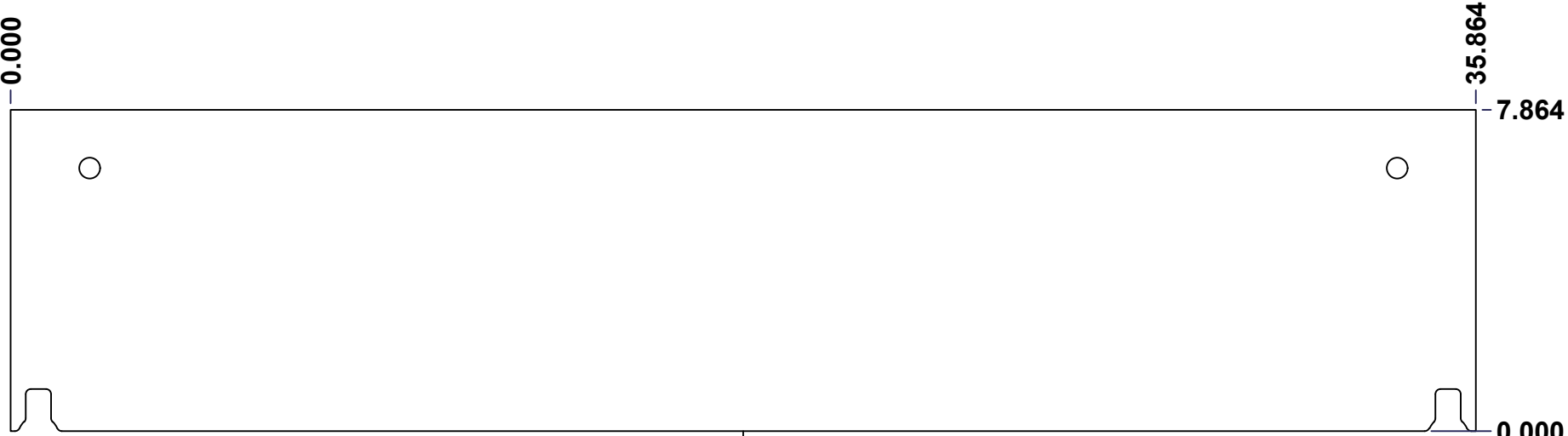

FRONT

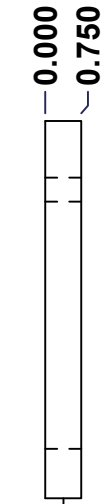

RIGHT

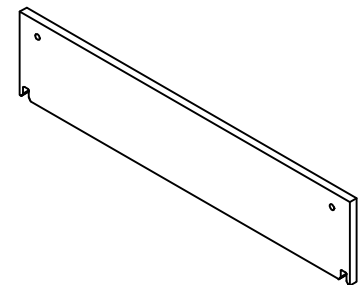

Isometric View

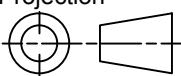

No.	Revisions	Date	By/Par

 Tél: (450) 979-4373 Fax: (450) 979-4626 www.exmweb.com		Flatness Aplatissement Max 3.0mm
Customer Client		Projection 
Drawn By / Dessiné Par: BoxCad: Patrick Deschenes		Date: 23-Jan-07
Material / Matière: Polyisocyanurate		
Color / Couleur: Aluminum	Finish / Fini: N/A	
Description: 5412ESSW 42" x 36" Top and Bottom Insulation		Detail Rev.
Part Number / Numéro Pièce: 5412ESSW4236086THI-TP		Rev. 0

SEE BILL OF MATERIAL ON LAST PAGE

This drawing is confidential and must not be reproduced or used without the consent of EXM

Ce dessin est confidentiel et ne doit pas être reproduit ou utilisé sans le consentement de EXM



TOP

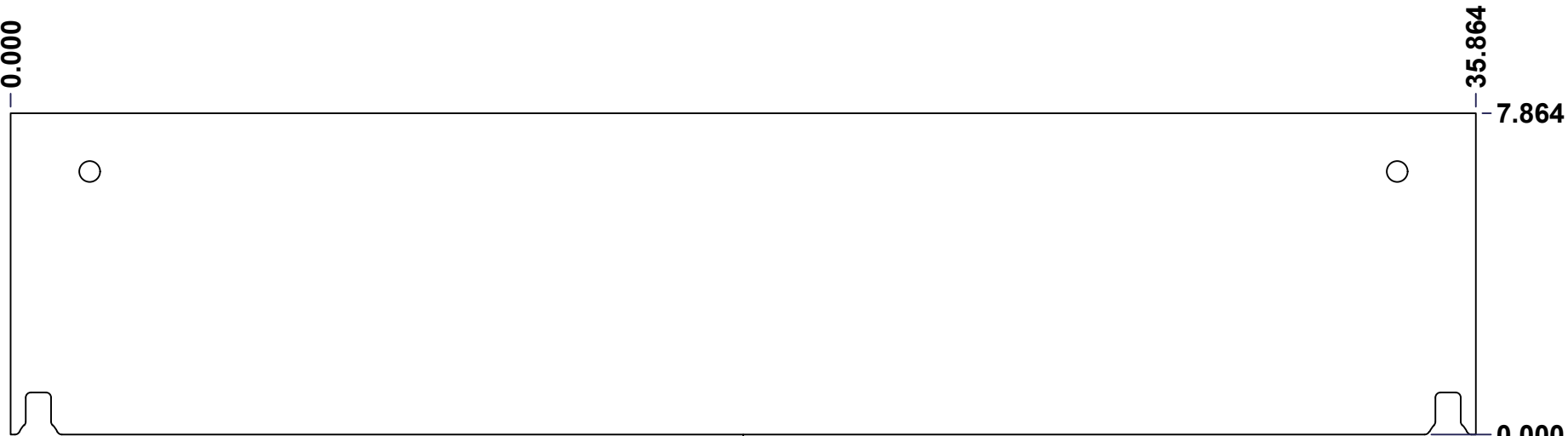

FRONT

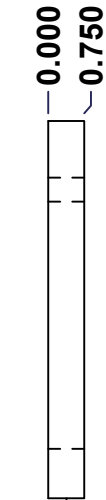

RIGHT

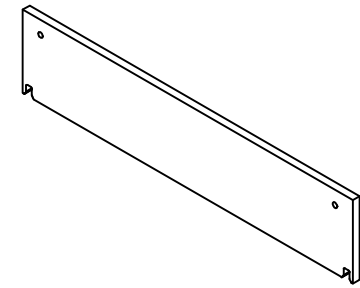

Isometric View

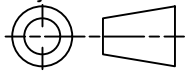

No.	Revisions	Date	By/Par

 Tél: (450) 979-4373 Fax: (450) 979-4626 www.exmweb.com		Flatness Aplatissement Max 3.0mm
Customer Client		Projection 
Drawn By / Dessiné Par: BoxCad: Patrick Deschenes		Date: 23-Jan-07
Material / Matière: Polyisocyanurate		
Color / Couleur: Aluminum	Finish / Fini: N/A	
Description: 5412ESSW 42" x 36" Top and Bottom Insulation		Detail Rev.
Part Number / Numéro Pièce: 5412ESSW4236086THI-BT		Rev. 0 / 15

SEE BILL OF MATERIAL ON LAST PAGE

This drawing is confidential and must not be reproduced or used without the consent of EXM

Ce dessin est confidentiel et ne doit pas être reproduit ou utilisé sans le consentement de EXM

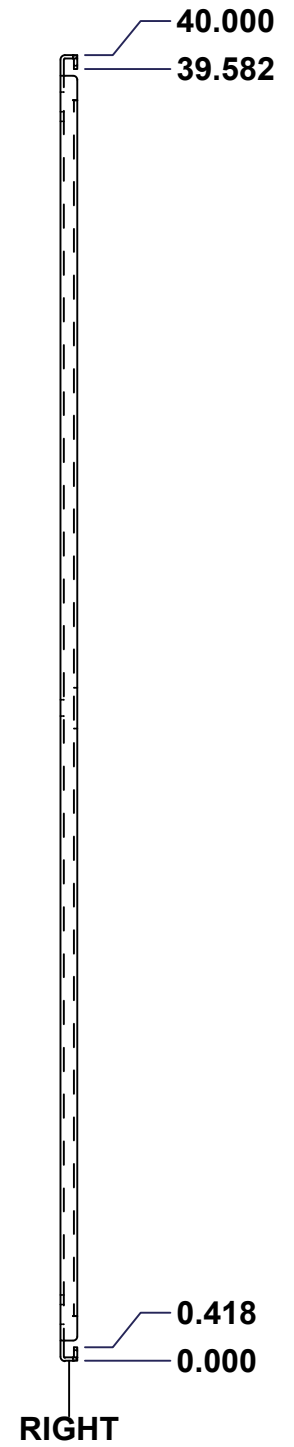
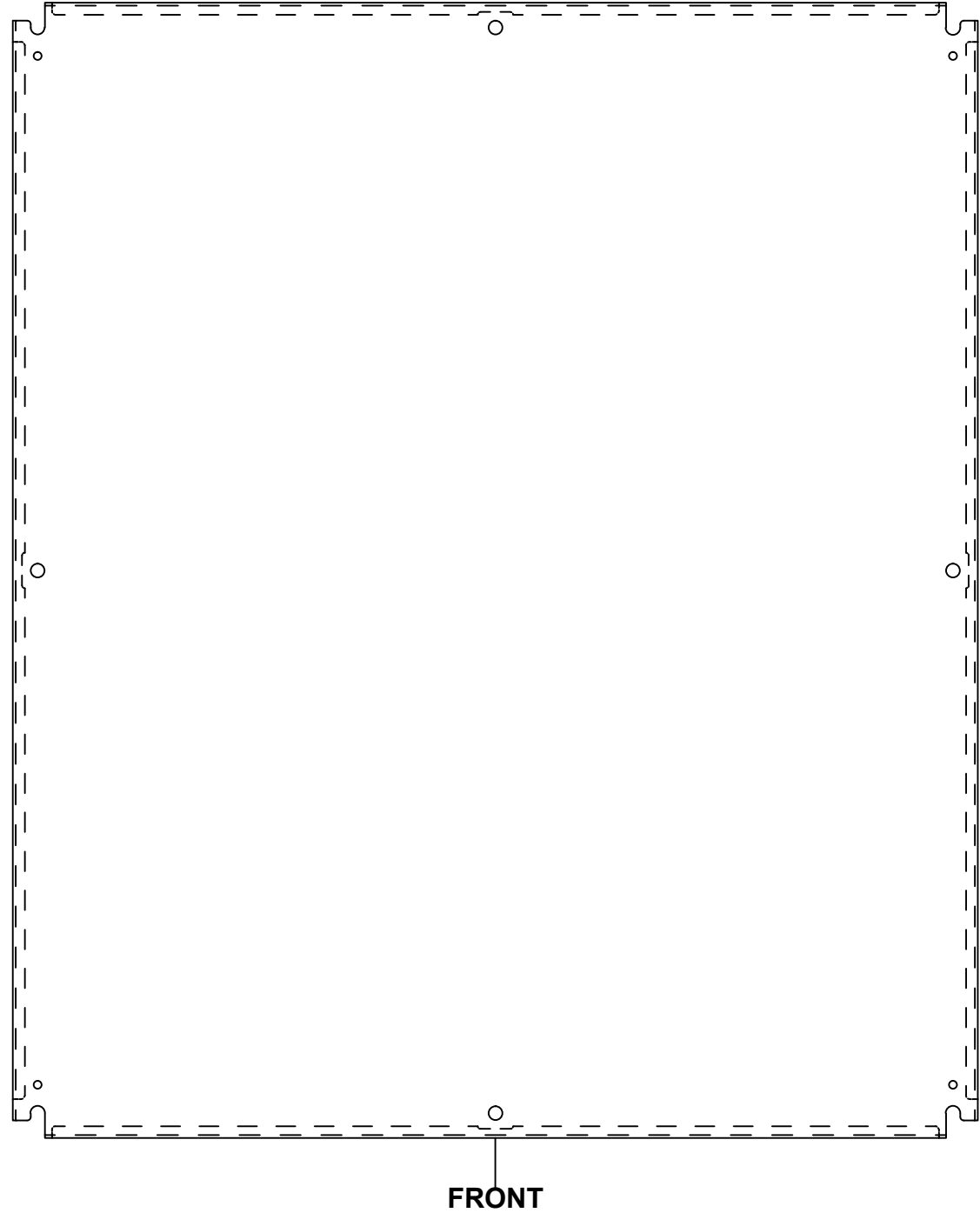
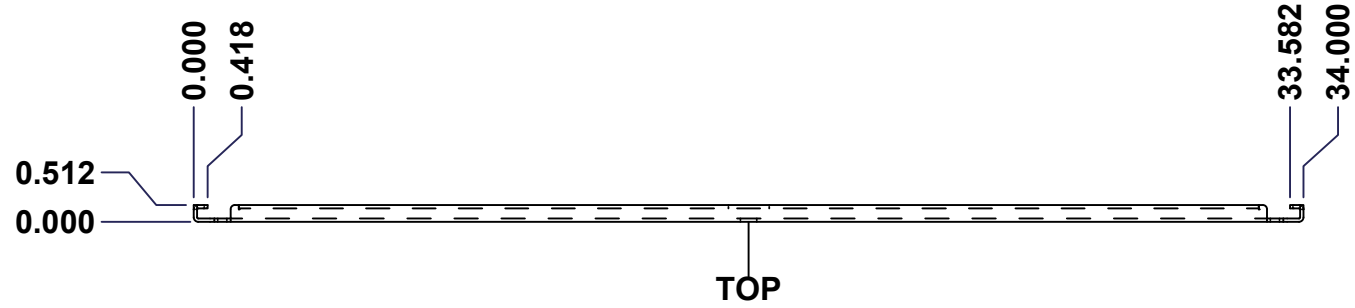

No.	Revisions	Date	By/Par

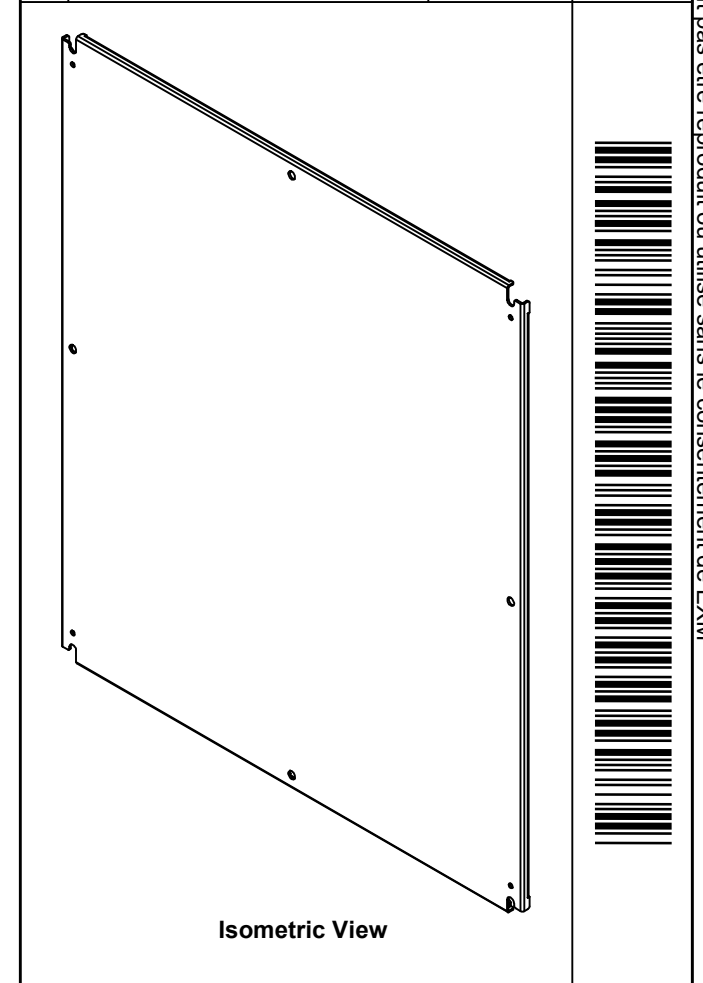

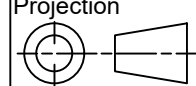
 Tél: (450) 979-4373 Fax: (450) 979-4626 www.exmweb.com	Flatness Aplatissement Max 3.0mm
	Projection 
Customer Client	Date
Drawn By Dessiné Par BoxCad	Date 23-Jan-07
Material Matière See Part List	
Color Couleur See Part List	Finish Fini See Part List
Description 881 SP - Inner Panel	
Detail Rev.	
Part Number Numéro Pièce 881 SP4236G	Rev. 0

Qty	Part Number	Rev	Description	Material	Color	Finish
1	881 SP4236G-P	0	881 SP - Inner Panel Part	12 Ga Galvanized	Unpainted	Galvanized

Parts List

This drawing is confidential and must not be reproduced or used without the consent of EXM

Ce dessin est confidentiel et ne doit pas être reproduit ou utilisé sans le consentement de EXM

Table 1			FRONT VIEW
CUT-OUT	XDIM	YDIM	DESCRIPTION
1	17.000	0.875	MTG STUD HOLE (RND Ø0.500)
2	0.875	20.000	MTG STUD HOLE (RND Ø0.500)
3	33.125	20.000	MTG STUD HOLE (RND Ø0.500)
4	17.000	39.125	MTG STUD HOLE (RND Ø0.500)
5	0.875	1.875	GROUND HOLE (RND Ø0.290)
6	33.125	1.875	GROUND HOLE (RND Ø0.290)
7	0.875	38.125	GROUND HOLE (RND Ø0.290)
8	33.125	38.125	GROUND HOLE (RND Ø0.290)

All knockouts are actual size / Les disques défonçables sont grandeur réel

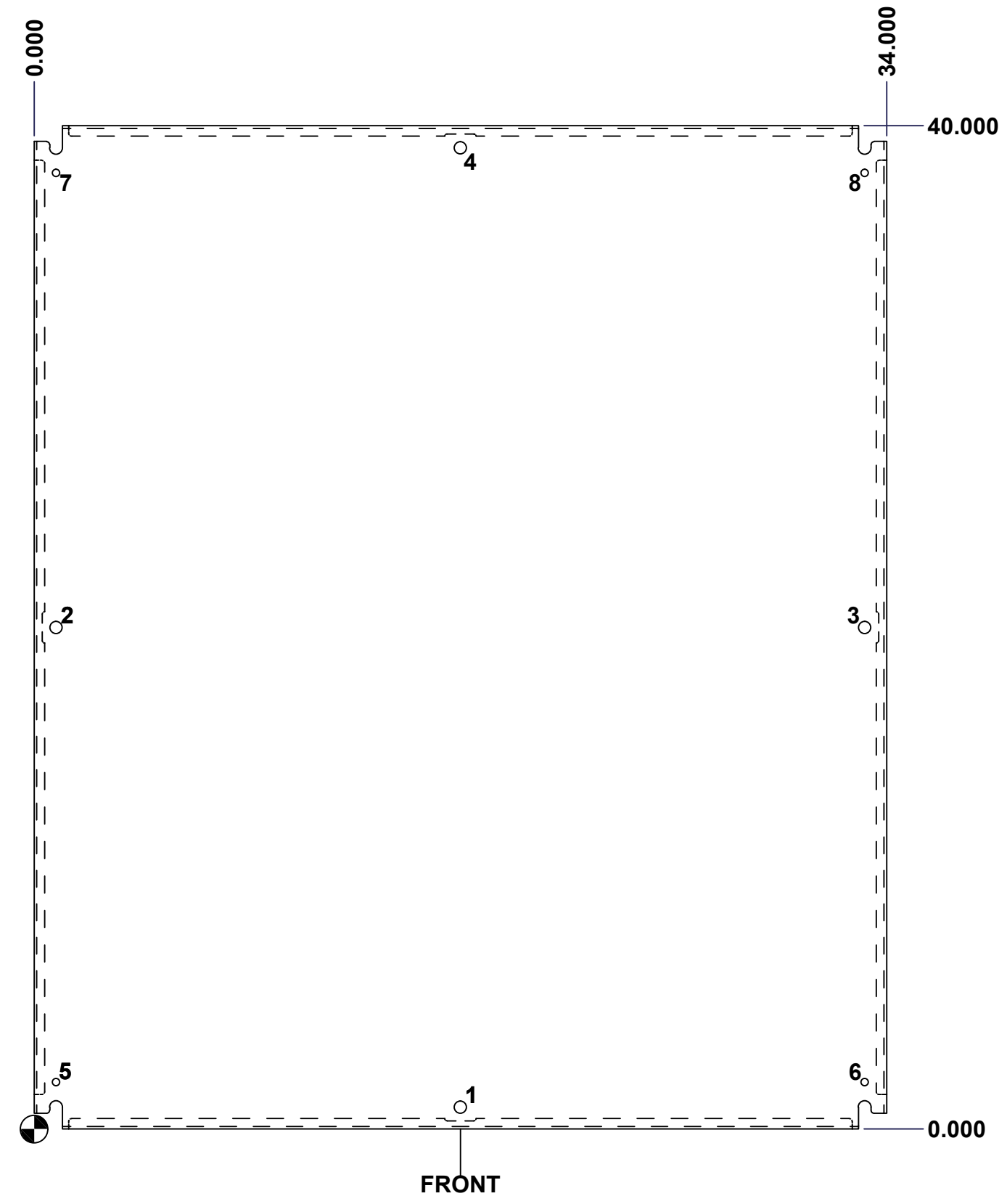

No.	Revisions	Date	By/Par

Isometric View

		Tél: (450) 979-4373 Fax: (450) 979-4626 www.exmweb.com		Flatness Aplatissement Max 3.0mm	
Customer Client		Date		Projection 	
Drawn By Dessiné Par BoxCad		Date 23-Jan-07		Material Matière See Part List	
Color Couleur See Part List		Finish Fini See Part List		Description 881 SP - Inner Panel	
Part Number Numéro Pièce 881 SP4236G		Rev. 0		Detail Rev. 2	