

This drawing is confidential and must not be reproduced or used without the consent of EXM

Ce dessin est confidentiel et ne doit pas être reproduit ou utilisé sans le consentement de EXM

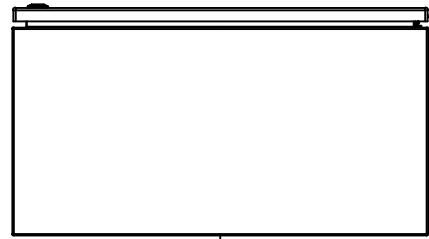

TOP

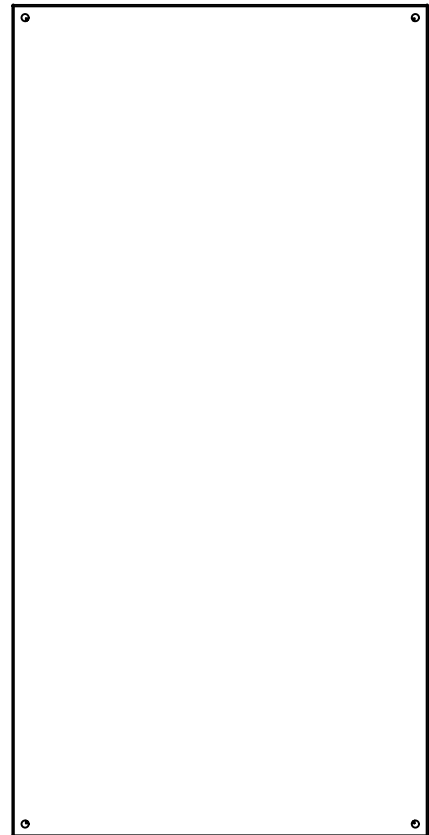

BACK

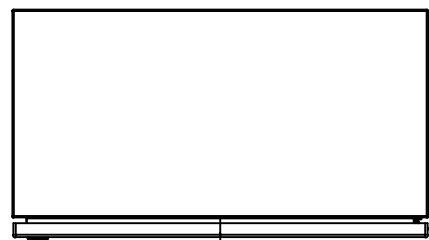

BOTTOM

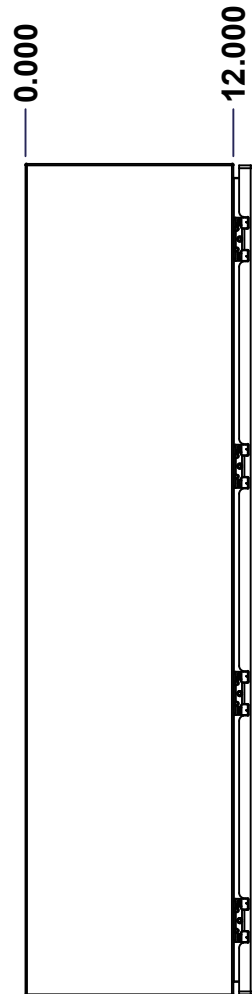

LEFT

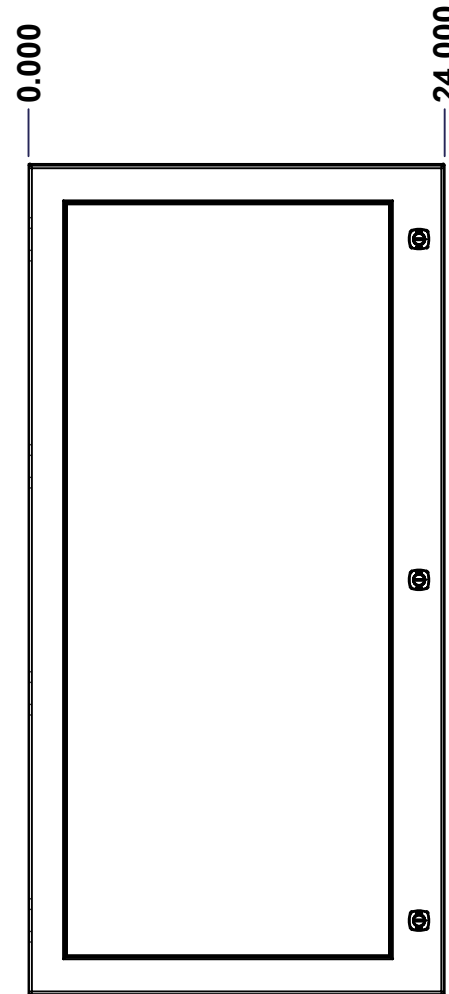

FRONT

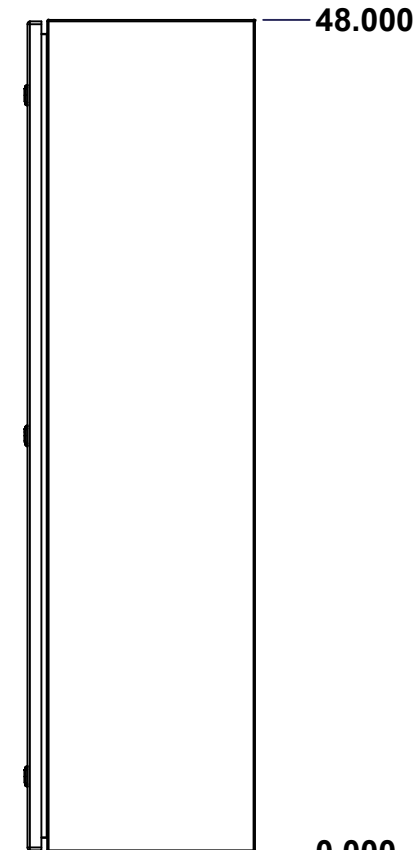

RIGHT

No.	Revisions	Date	By/Par

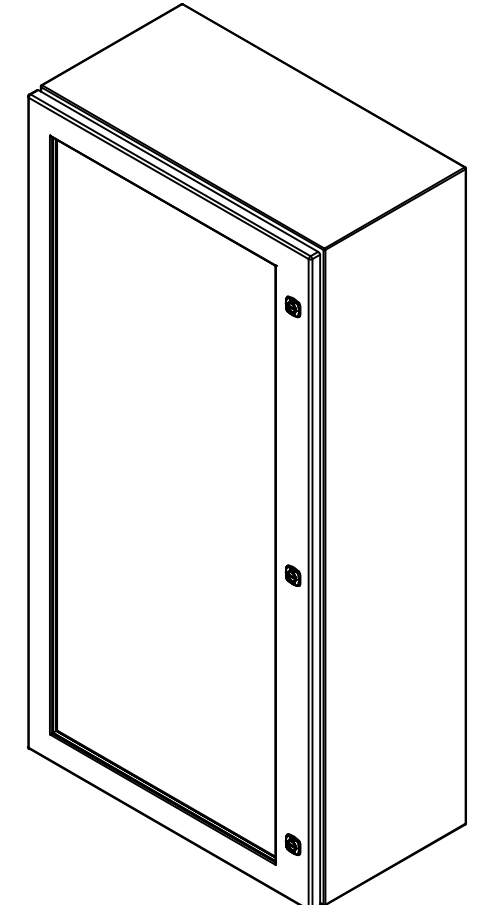

Isometric View



**GRAIN DIRECTION:
TOP/BOTTOM: HORIZONTAL
LEFT/RIGHT/BACK/FRONT: VERTICAL**

SEE BILL OF MATERIAL ON LAST PAGE

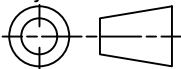
 Tél: (450) 979-4373 Fax: (450) 979-4626 www.exmweb.com		Flatness Aplatissement Max 3.0mm Projection 
Customer Client	Date	
Drawn By Dessiné Par	BoxCad: BoxCad	Date 22-Jun-23
Material Matière	16 Ga Stainless Steel 316 (1.4mm)	
Color Couleur	Unpainted	Finish Fini Brushed
Description	Detail Rev.	
5412ESSW 48" x 24" x 12" Assembly		
Part Number Numéro Pièce	Rev.	1
5412ESSW4824126	0	9

This drawing is confidential and must not be reproduced or used without the consent of EXM

Ce dessin est confidentiel et ne doit pas être reproduit ou utilisé sans le consentement de EXM

NOTE	
ITEM	DESCRIPTION
1	NEMA 4X Enclosure
2	C/W Standard ground studs on box and cover
3	W/O Standard door stiffener
4	C/W Standard inner panel (Included)
5	C/W Standard inner panel mounting studs

No.	Revisions	Date	By/Par

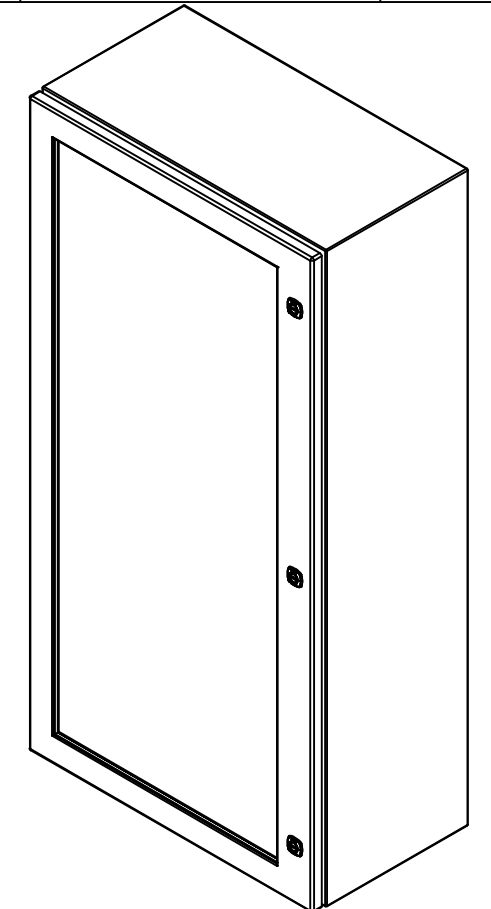

Isometric View



PACKING		
ITEM	QTY	DESCRIPTION
Cardboard sleeve	2	Top and Bottom
Cardboard strip	2	Between back of enclosure and inner panel
Plastic bag	1	To protect cover surface and inside gasket
Cardboard corner	4	To reinforced for the plastic strap tightening
Plastic strap - Black	2	To Squeeze the 2 cardboard sleeve together
Packaging label	3	White label with PN
Plastic strap- Green	2	To secure the enclosure to the wood pallet
Wood Pallet	1	2" deeper and 3" larger than enclosure size

1	881 SP4824G	0	881 SP - Inner Panel
3	STK-K-01320	0	5412 ES Inner Panel Accessory Kit
1	STK-K-01800	5	5412 ES Accessory Kit
1	5412ESSW4824126C	0	5412ESSW 48" x 24" Cover
1	5412ESSW4824126B	0	5412ESSW 48" x 24" x 12" Body
4	STK-Q-04051-08	1	M6 x 8mm Stainless Steel Hexagon Socket Head Machine Screw with Nyseal

Qty	Part Number	Rev	Description
Parts List			



Tél: (450) 979-4373
Fax: (450) 979-4626
www.exmweb.com

Flatness
Aplatissement
Max 3.0mm

Projection

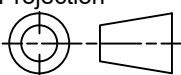

Customer Client	Date
Drawn By Dessiné Par	Date 22-Jun-23
Material Matière	16 Ga Stainless Steel 316 (1.4mm)
Color Couleur	Unpainted Finish Brushed
Description	Detail Rev.
5412ESSW 48" x 24" x 12" Assembly	
Part Number Numéro Pièce	Rev. 2
5412ESSW4824126	0

This drawing is confidential and must not be reproduced or used without the consent of EXM

Ce dessin est confidentiel et ne doit pas être reproduit ou utilisé sans le consentement de EXM

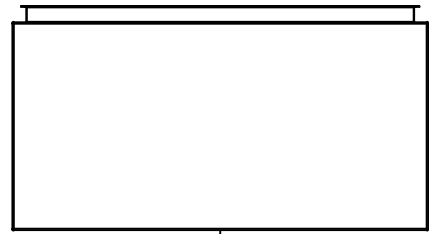

TOP

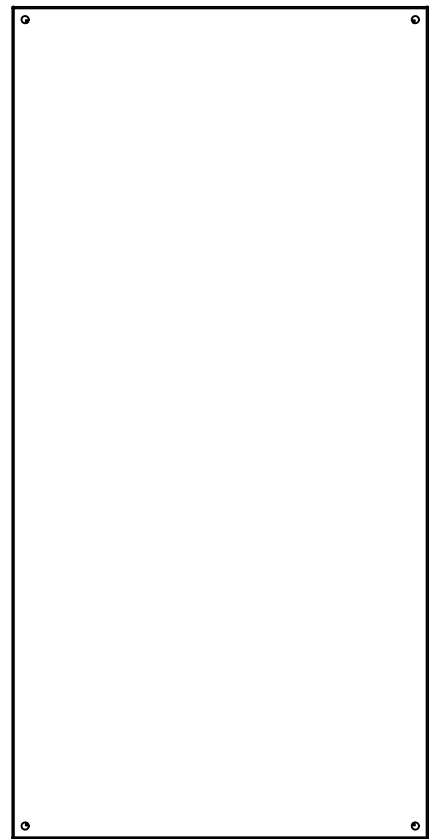

BACK

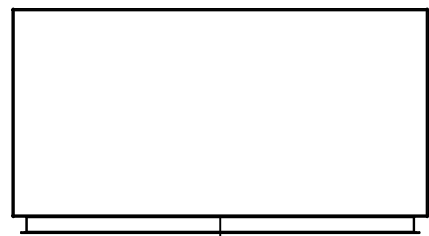

BOTTOM

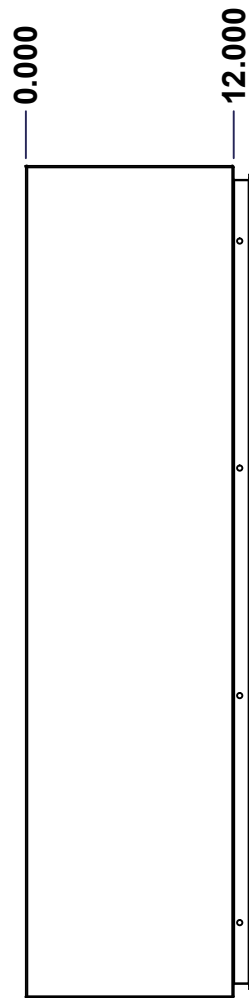

LEFT

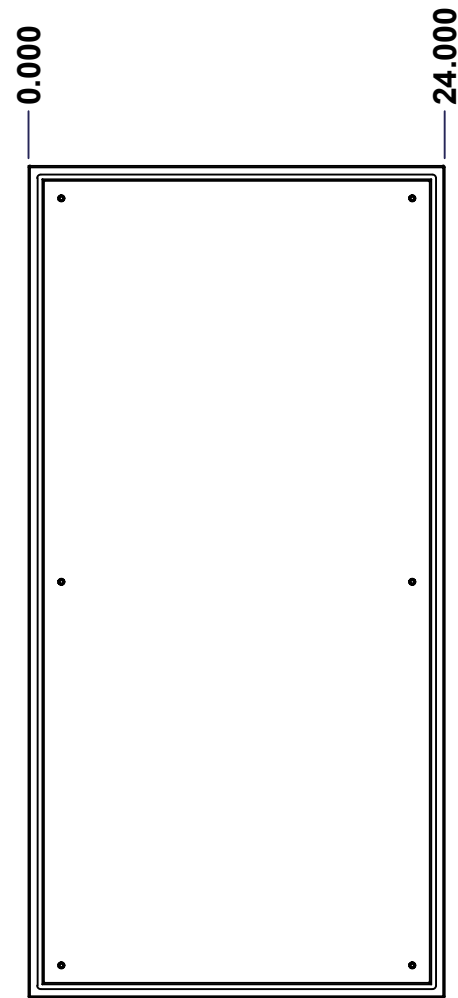

FRONT

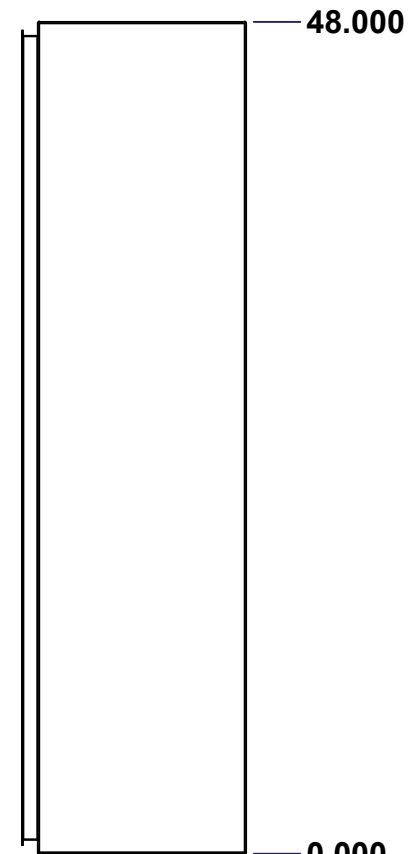

RIGHT

No.	Revisions	Date	By/Par

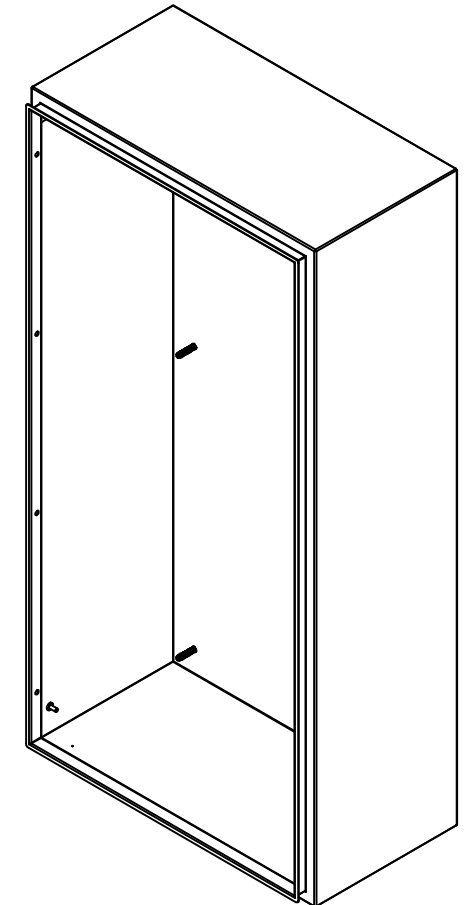

Isometric View

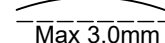
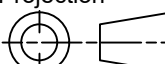

 Tél: (450) 979-4373 Fax: (450) 979-4626 www.exmweb.com		Flatness Aplatissement  Max 3.0mm Projection 
Customer Client	Date	
Drawn By Dessiné Par	BoxCad: BoxCad	Date 22-Jun-23
Material Matière	16 Ga Stainless Steel 316 (1.4mm)	
Color Couleur	Unpainted	Finish Fini Brushed
Description	Detail Rev.	
5412ESSW 48" x 24" x 12" Body		
Part Number Numéro Pièce	Rev.	3
5412ESSW4824126B	0	9

SEE BILL OF MATERIAL ON LAST PAGE

This drawing is confidential and must not be reproduced or used without the consent of EXM

Ce dessin est confidentiel et ne doit pas être reproduit ou utilisé sans le consentement de EXM

STANDARD FEATURES ARE NOT LISTED IN THIS HOLE TABLE			
HOLE TABLE - LEFT VIEW (CUSTOM FEATURE ONLY)			
CUT-OUT	XDIM	YDIM	DESCRIPTION
1	10.500	2.000	GND STUD M6 x 16mm (Inside)
2	10.000	46.000	LABEL_EXM (Inside)

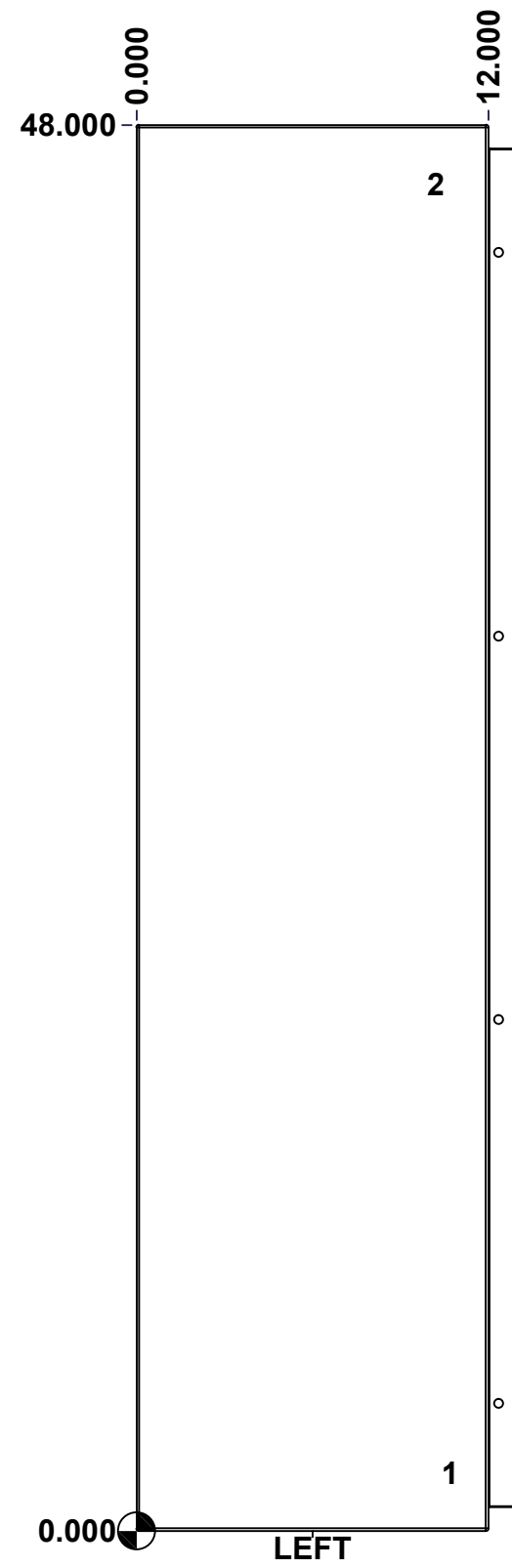

	Description	Status	
	5412ESSW 48" x 24" x 12" Body	(NULL)	
	Part Number Numéro Pièce	Rev.	
	5412ESSW4824126B	0	4/9

This drawing is confidential and must not be reproduced or used without the consent of EXM

Ce dessin est confidentiel et ne doit pas être reproduit ou utilisé sans le consentement de EXM

STANDARD FEATURES ARE NOT LISTED IN THIS HOLE TABLE

HOLE TABLE - BACK VIEW (CUSTOM FEATURE ONLY)

CUT-OUT	XDIM	YDIM	DESCRIPTION
1	1.875	1.875	IP STUD M8 x 35mm (Inside)
2	1.875	46.125	IP STUD M8 x 35mm (Inside)
3	22.125	46.125	IP STUD M8 x 35mm (Inside)
4	22.125	1.875	IP STUD M8 x 35mm (Inside)
5	1.875	24.000	IP STUD M8 x 35mm (Inside)
6	22.125	24.000	IP STUD M8 x 35mm (Inside)

7	0.750	47.250	RND Ø0.390
8	0.750	0.750	RND Ø0.390
9	23.250	0.750	RND Ø0.390
10	23.250	47.250	RND Ø0.390

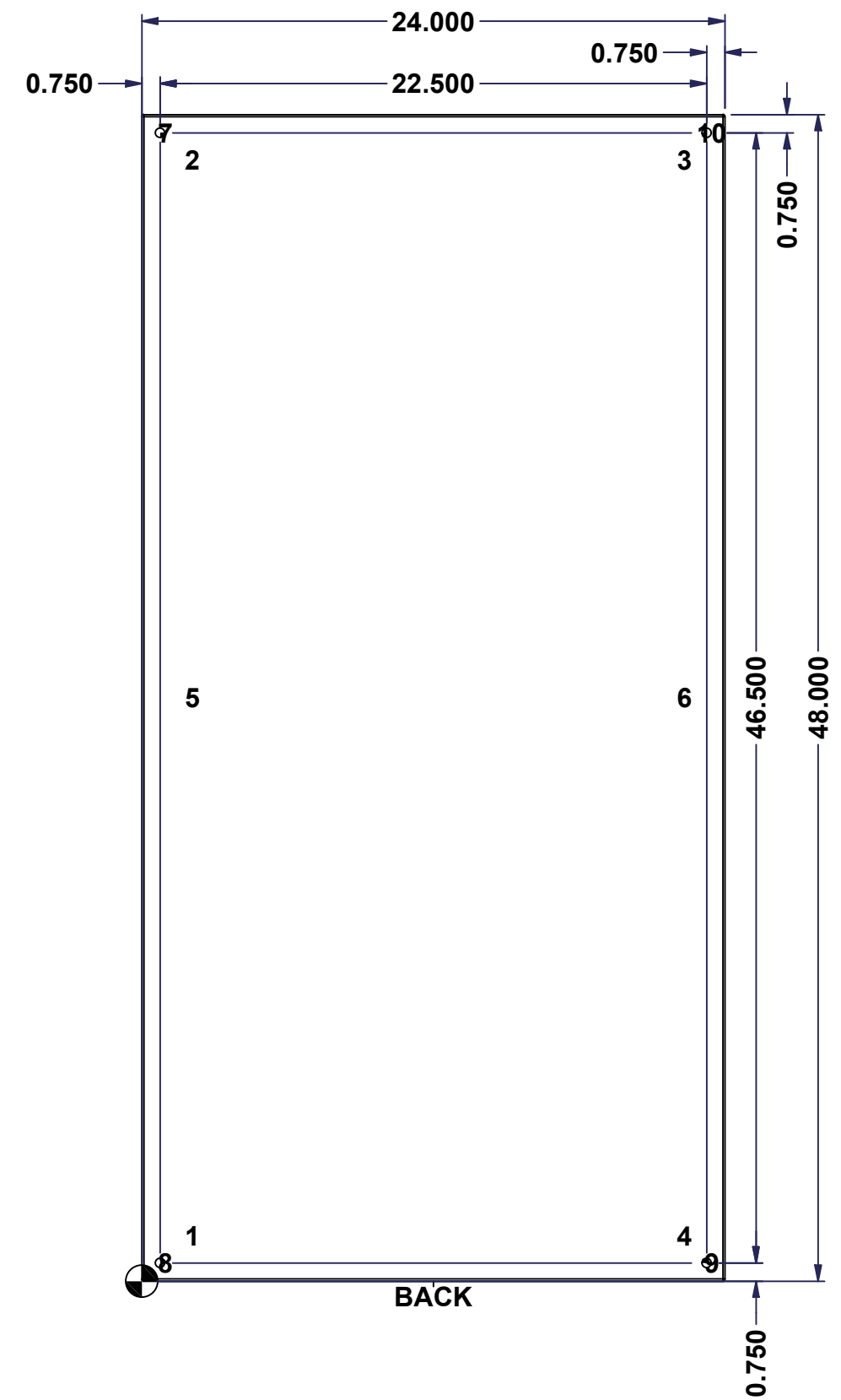

	Description	Status
	5412ESSW 48" x 24" x 12" Body	(NULL)
	Part Number Numéro Pièce	Rev.
	5412ESSW4824126B	0 / 5 / 9

This drawing is confidential and must not be reproduced or used without the consent of EXM

Ce dessin est confidentiel et ne doit pas être reproduit ou utilisé sans le consentement de EXM

No.	Revisions	Date	By/Par

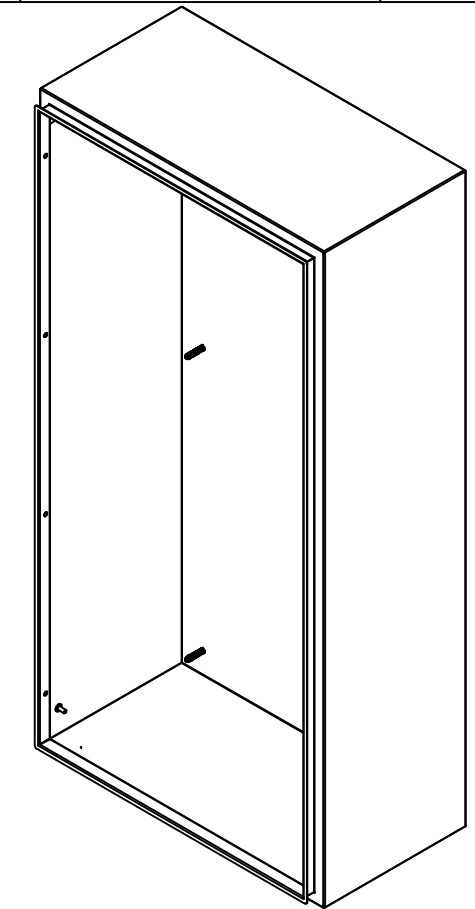

Isometric View



 Tél: (450) 979-4373 Fax: (450) 979-4626 www.exmweb.com		Flatness Aplatissement Max 3.0mm
Customer Client		Date
Drawn By / Dessiné Par: BoxCad: BoxCad		Date: 22-Jun-23
Material / Matière: 16 Ga Stainless Steel 316 (1.4mm)		
Color / Couleur: Unpainted	Finish / Fini: Brushed	
Description: 5412ESSW 48" x 24" x 12" Body		Detail Rev.
Part Number / Numéro Pièce: 5412ESSW4824126B		Rev. 0

Qty	Part Number	Rev	Description
1	STK-S-00100	0	3.5" x 2" Silver Milar Flexcon Sticker
1	STK-Q-16085	0	Ground Stud M6 x 16mm Stainless Steel
6	STK-Q-16020	1	Stud M8 x 35mm Stainless Steel
1	5412ESSW4824126B-P	0	5412ESSW 48" x 24" x 12" Body Part
Parts List			

This drawing is confidential and must not be reproduced or used without the consent of EXM

Ce dessin est confidentiel et ne doit pas être reproduit ou utilisé sans le consentement de EXM

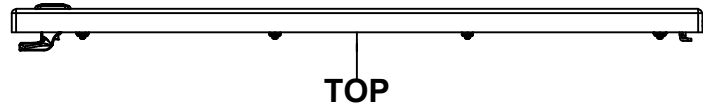

TOP

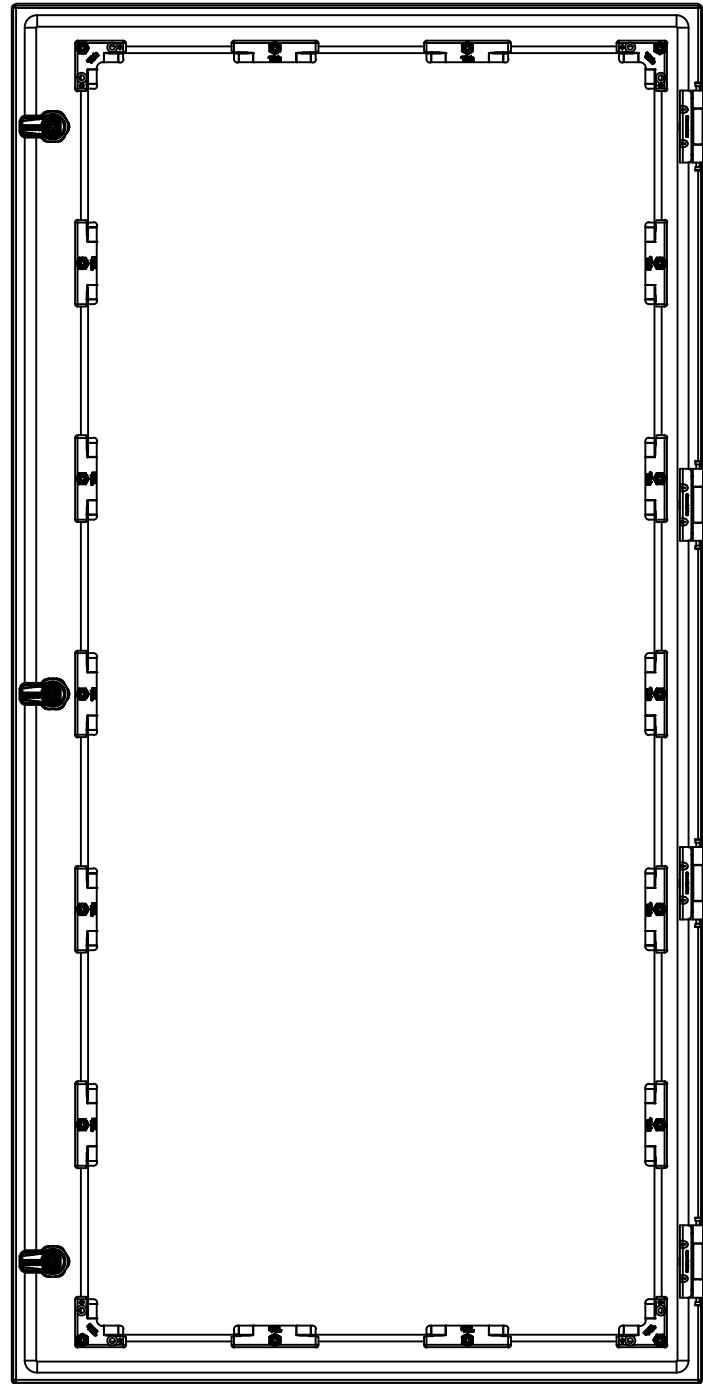

BACK

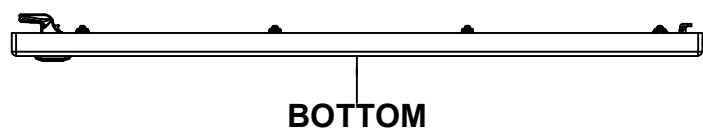

BOTTOM

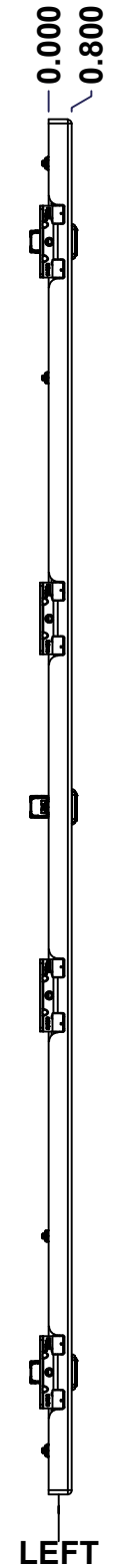

LEFT

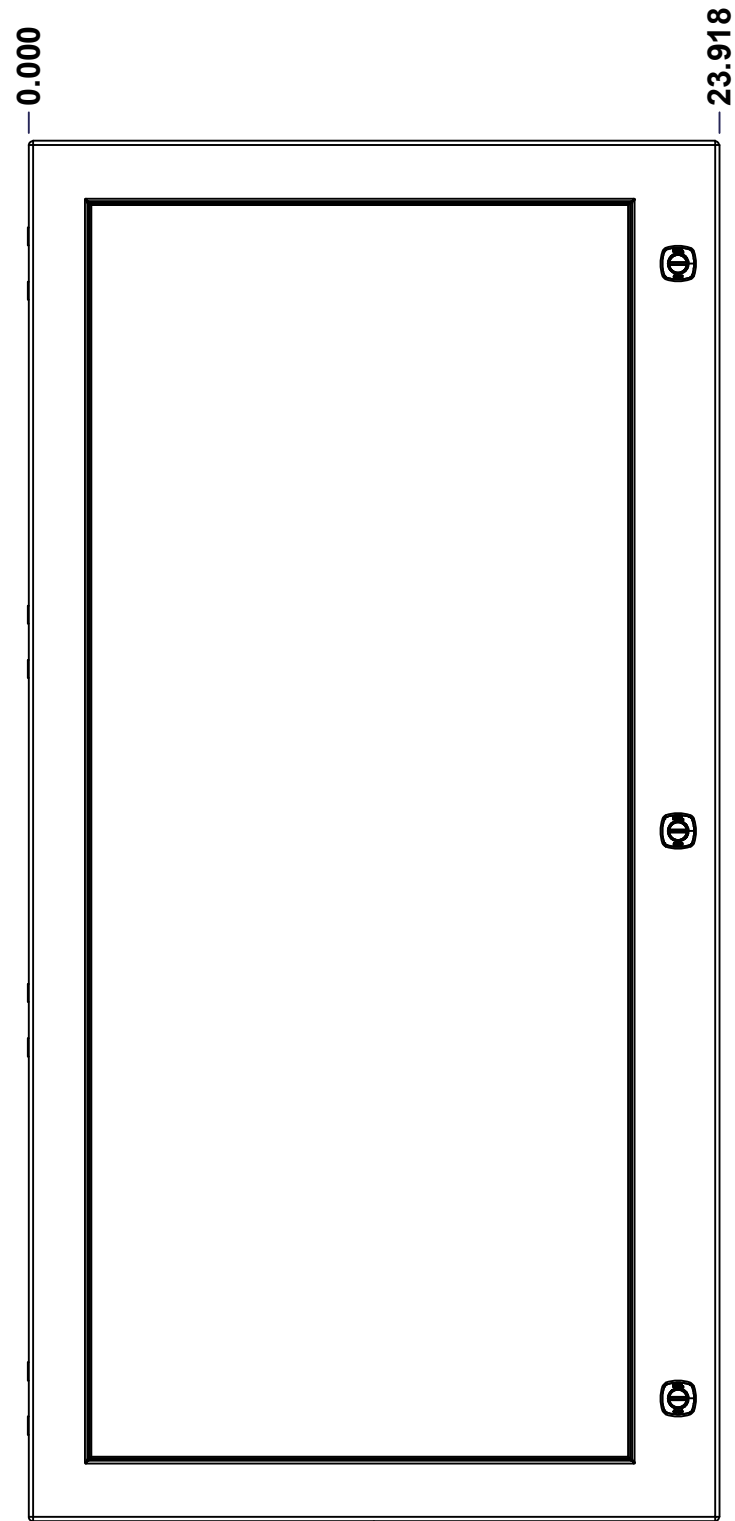

FRONT

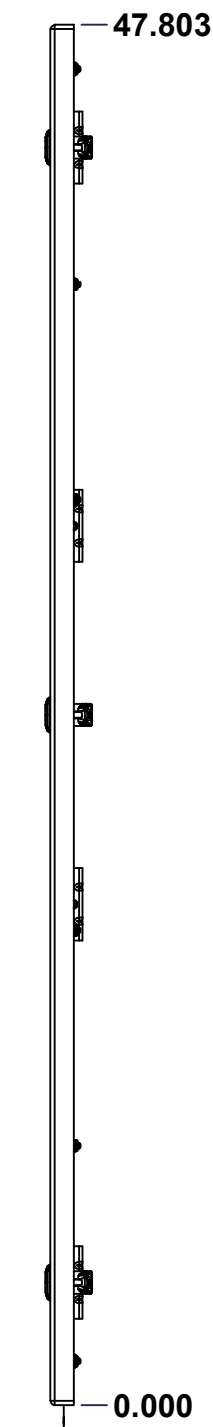

RIGHT

No.	Revisions	Date	By/Par

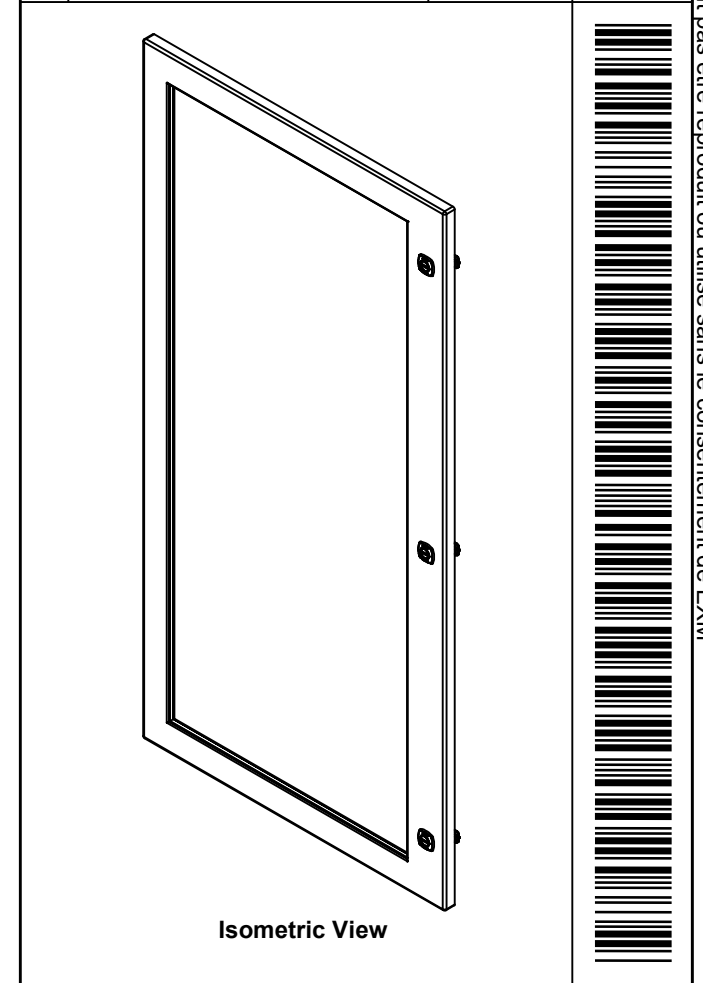

<p>Tél: (450) 979-4373 Fax: (450) 979-4626 www.exmweb.com</p>		Flatness Aplatissement Max 3.0mm Projection
Customer Client	Date	
Drawn By Dessiné Par	BoxCad: BoxCad	Date 22-Jun-23
Material Matière	16 Ga Stainless Steel 316 (1.4mm)	
Color Couleur	Unpainted	Finish Fini Brushed
Description	Detail Rev.	
5412ESSW 48" x 24" Cover		
Part Number Numéro Pièce	Rev.	7
5412ESSW4824126C	0	9

SEE BILL OF MATERIAL ON LAST PAGE

This drawing is confidential and must not be reproduced or used without the consent of EXM

Ce dessin est confidentiel et ne doit pas être reproduit ou utilisé sans le consentement de EXM

STANDARD FEATURES ARE NOT LISTED IN THIS HOLE TABLE			
HOLE TABLE - FRONT VIEW (CUSTOM FEATURE ONLY)			
CUT-OUT	XDIM	YDIM	DESCRIPTION
1	1.469	8.985	STUD M6 x 18mm (Inside)
2	21.468	8.985	STUD M6 x 18mm (Inside)
3	1.469	16.443	STUD M6 x 18mm (Inside)
4	21.468	16.443	STUD M6 x 18mm (Inside)
5	1.469	23.902	STUD M6 x 18mm (Inside)
6	21.468	23.902	STUD M6 x 18mm (Inside)
7	1.469	31.360	STUD M6 x 18mm (Inside)
8	21.468	31.360	STUD M6 x 18mm (Inside)
9	1.469	38.818	STUD M6 x 18mm (Inside)
10	21.468	38.818	STUD M6 x 18mm (Inside)
11	1.469	46.276	STUD M6 x 18mm (Inside)
12	1.469	1.527	STUD M6 x 18mm (Inside)
13	8.135	46.276	STUD M6 x 18mm (Inside)
14	8.135	1.527	STUD M6 x 18mm (Inside)
15	14.802	46.276	STUD M6 x 18mm (Inside)
16	14.802	1.527	STUD M6 x 18mm (Inside)
17	21.468	46.276	STUD M6 x 18mm (Inside)
18	21.468	1.527	STUD M6 x 18mm (Inside)

19	22.494	43.553	880 SCQ4-SLSS6
20	22.494	23.902	880 SCQ4-SLSS6
21	22.494	4.250	880 SCQ4-SLSS6

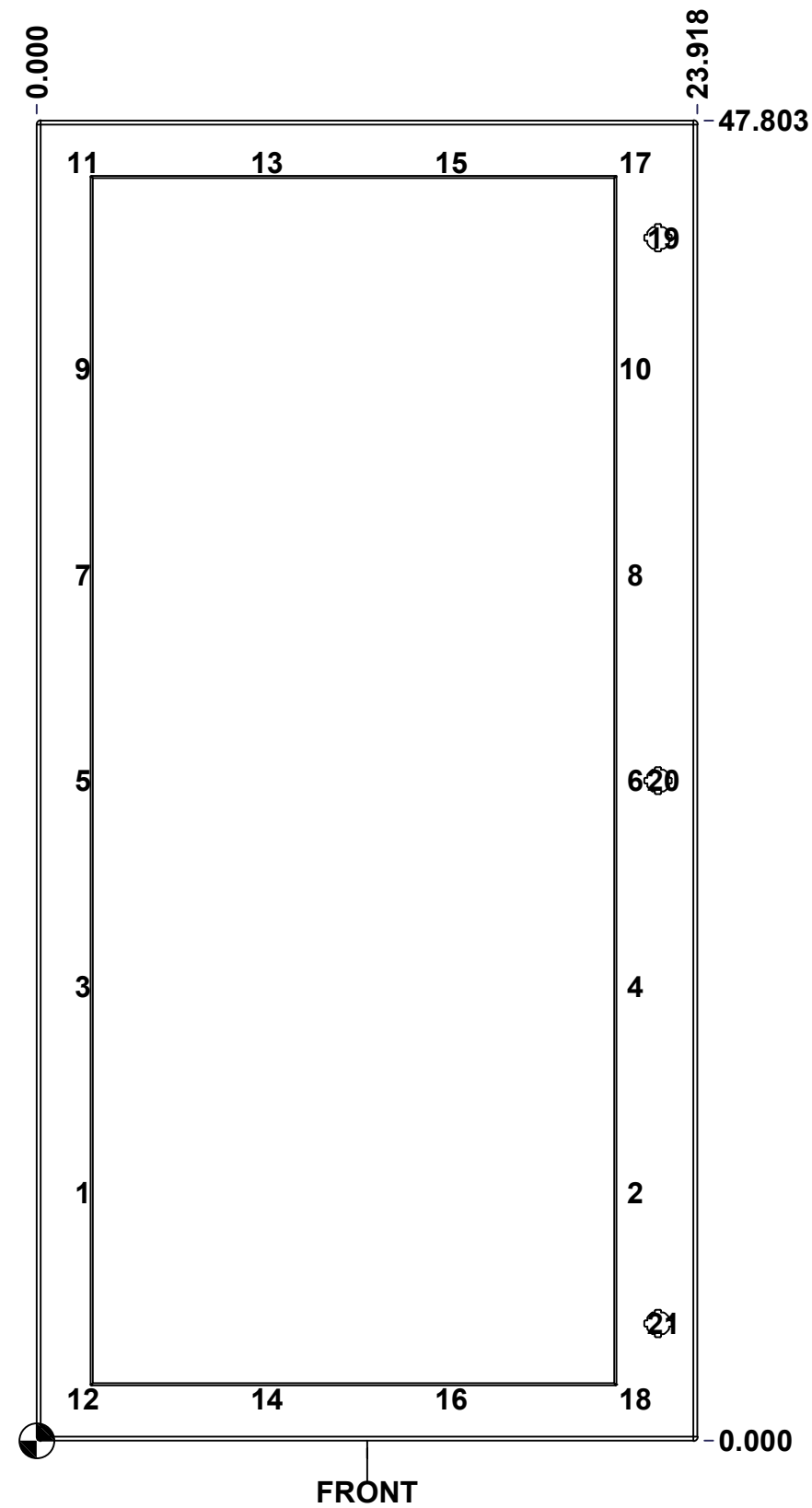

	Description	Status
	5412ESSW 48" x 24" Cover	(NULL)
	Part Number Numéro Pièce	Rev.
	5412ESSW4824126C	0
		8 9

This drawing is confidential and must not be reproduced or used without the consent of EXM

Ce dessin est confidentiel et ne doit pas être reproduit ou utilisé sans le consentement de EXM

No.	Revisions	Date	By/Par

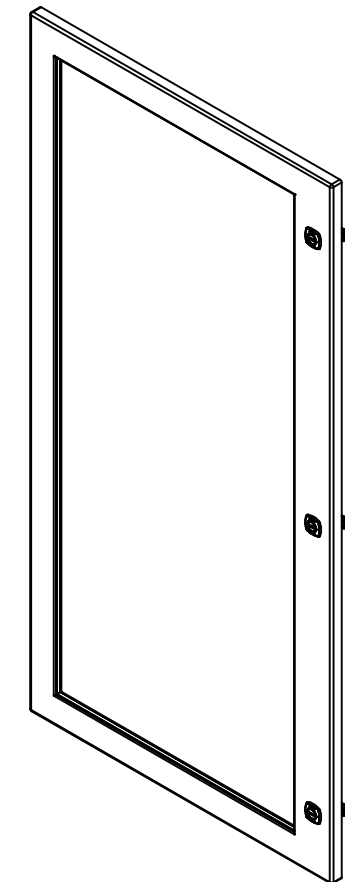

Isometric View

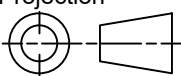

QTY	Part Number	Rev	Description
14	STK-Q-60701	2.1	880 WK - Lexan 1/4" Fixing Bracket
1	STK-A-60703	0	5412 ESW Lexan Bracket Kit
18	STK-Q-16053	1	Stud M6 x 23mm Stainless steel
1	STK-G-02710	0	880 HWKG - Windows Kit Gasket
1	5412ESSW4824126LXG	0	5412ESSW 48" x 24" Lexan Gasket Part
1	5412ESSW4824126LX	0	5412ESSW 44.375" x 20.125" Lexan Part
1	5412ESSW4824126G	0	5412ESSW 48" x 24" Cover Gasket Part
1	5412ESSW4824126C-P	0	5412ESSW 48" x 24" Cover Part
3	880 SCQ4-SLSS6	7	5412 ESS 1/4 Turn Lock
4	STK-A-33016	0	5412 ESS Bended Hinge (Body Part)
Parts List			

 Tél: (450) 979-4373 Fax: (450) 979-4626 www.exmweb.com		Flatness Aplatissement Max 3.0mm Projection 
Customer Client	Date	
Drawn By Dessiné Par	BoxCad: BoxCad	Date 22-Jun-23
Material Matière	16 Ga Stainless Steel 316 (1.4mm)	
Color Couleur	Unpainted	Finish Fini Brushed
Description		Detail Rev.
5412ESSW 48" x 24" Cover		
Part Number Numéro Pièce	Rev.	9
5412ESSW4824126C	0	9

This drawing is confidential and must not be reproduced or used without the consent of EXM

Ce dessin est confidentiel et ne doit pas être reproduit ou utilisé sans le consentement de EXM

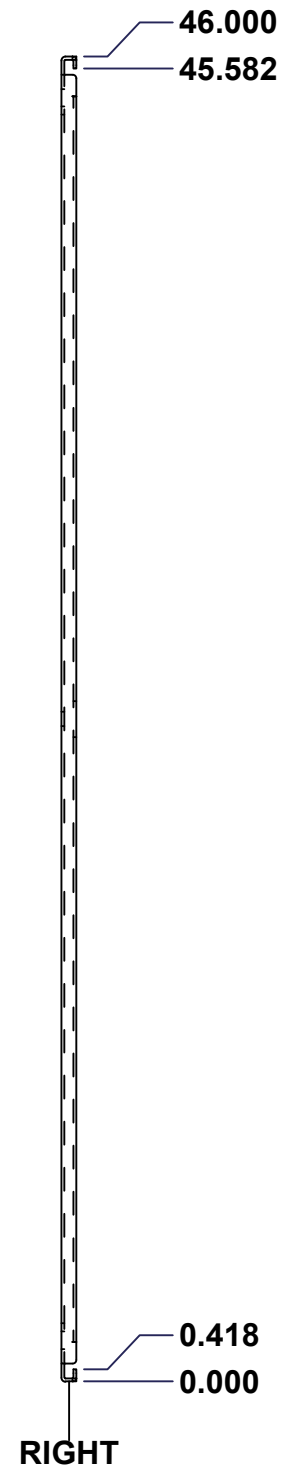
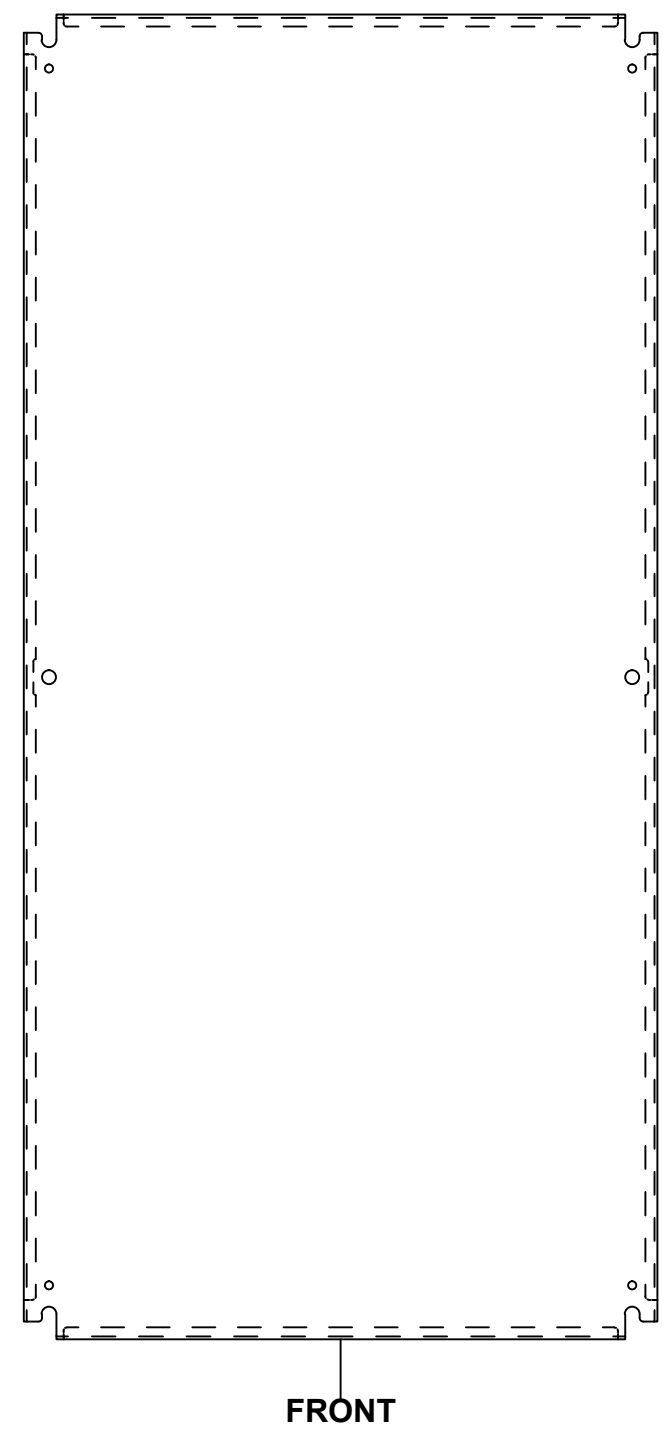
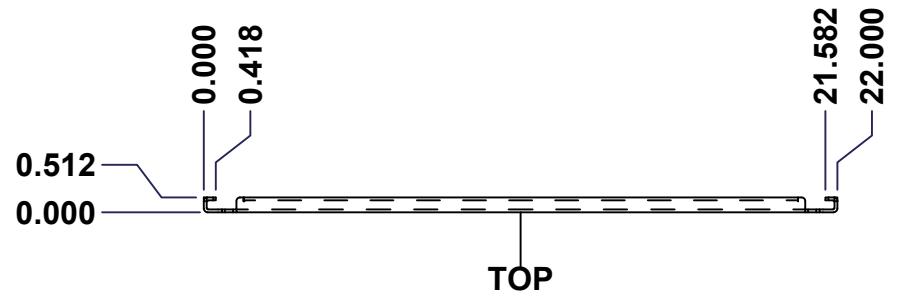

No.	Revisions	Date	By/Par

Isometric View

Tél: (450) 979-4373 Fax: (450) 979-4626 www.exmweb.com		Flatness Aplatissement Max 3.0mm Projection
Customer Client	Date	
Drawn By / Dessiné Par: BoxCad	Date: 23-Jan-07	
Material / Matière	See Part List	
Color / Couleur	See Part List	Finish / Fini: See Part List
Description: 881 SP - Inner Panel		Detail Rev.
Part Number / Numéro Pièce: 881 SP4824G	Rev.:	1 / 2

Qty	Part Number	Rev	Description	Material	Color	Finish
1	881 SP4824G-P	0	881 SP - Inner Panel Part	12 Ga Galvanized	Unpainted	Galvanized

Parts List

This drawing is confidential and must not be reproduced or used without the consent of EXM

Ce dessin est confidentiel et ne doit pas être reproduit ou utilisé sans le consentement de EXM

Table 1			FRONT VIEW
CUT-OUT	XDIM	YDIM	DESCRIPTION
1	0.875	1.875	GROUND HOLE (RND Ø0.290)
2	21.125	1.875	GROUND HOLE (RND Ø0.290)
3	0.875	44.125	GROUND HOLE (RND Ø0.290)
4	21.125	44.125	GROUND HOLE (RND Ø0.290)
5	0.875	23.000	MTG STUD HOLE (RND Ø0.500)
6	21.125	23.000	MTG STUD HOLE (RND Ø0.500)

All knockouts are actual size / Les disques défonçables sont grandeur réel

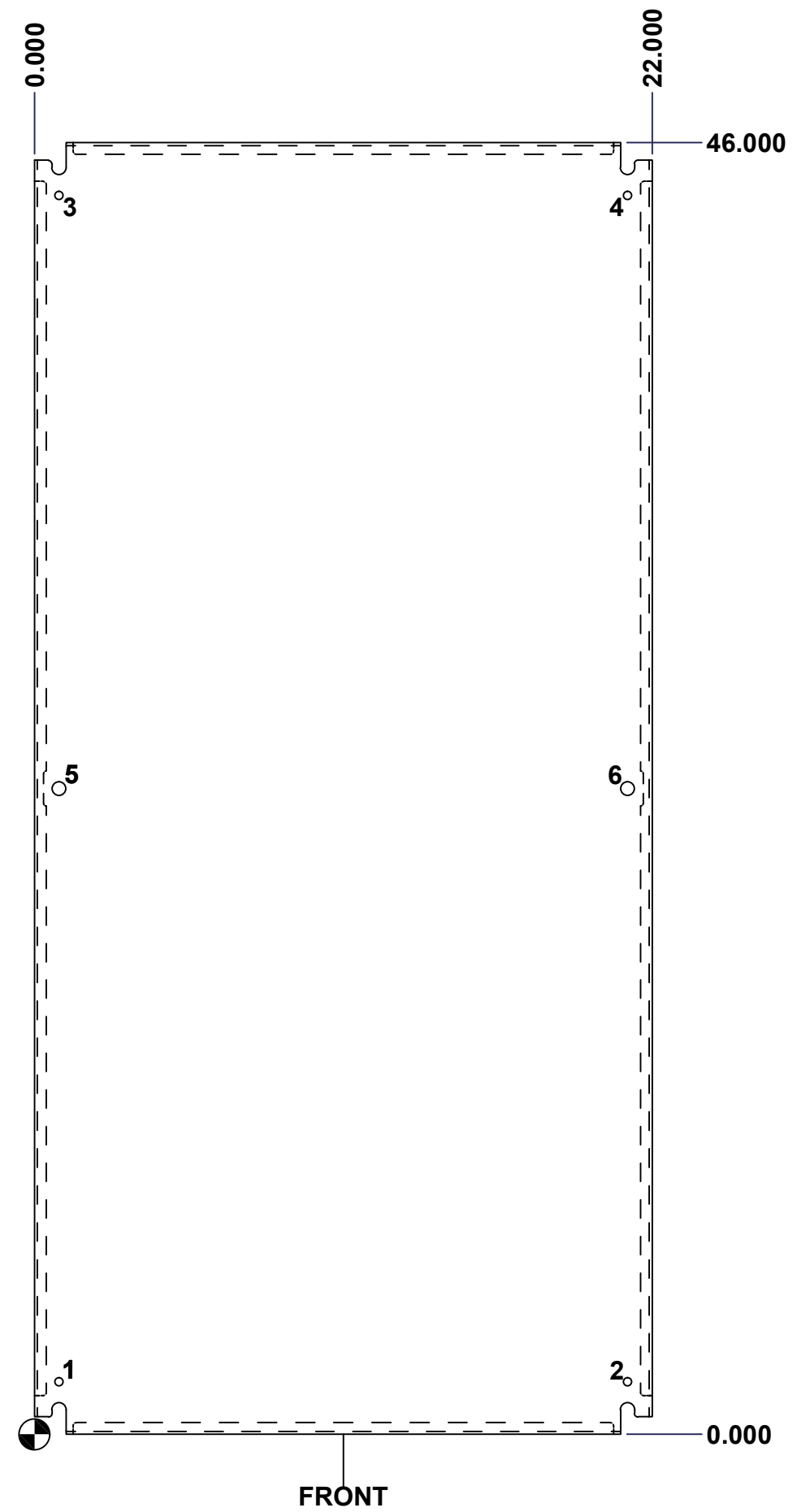

No.	Revisions	Date	By/Par

Isometric View

		Tél: (450) 979-4373 Fax: (450) 979-4626 www.exmweb.com		Flatness Aplatissement Max 3.0mm	
Customer Client		Date		Projection 	
Drawn By Dessiné Par BoxCad		Date 23-Jan-07		Material Matière See Part List	
Color Couleur See Part List		Finish Fini See Part List		Description 881 SP - Inner Panel	
Part Number Numéro Pièce 881 SP4824G		Rev. 0		Detail Rev. 2	