

This drawing is confidential and must not be reproduced or used without the consent of EXM

Ce dessin est confidentiel et ne doit pas être reproduit ou utilisé sans le consentement de EXM

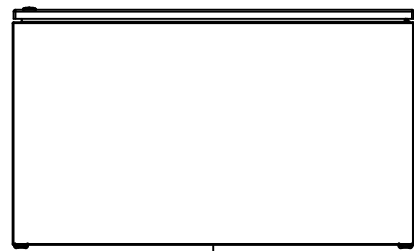

TOP

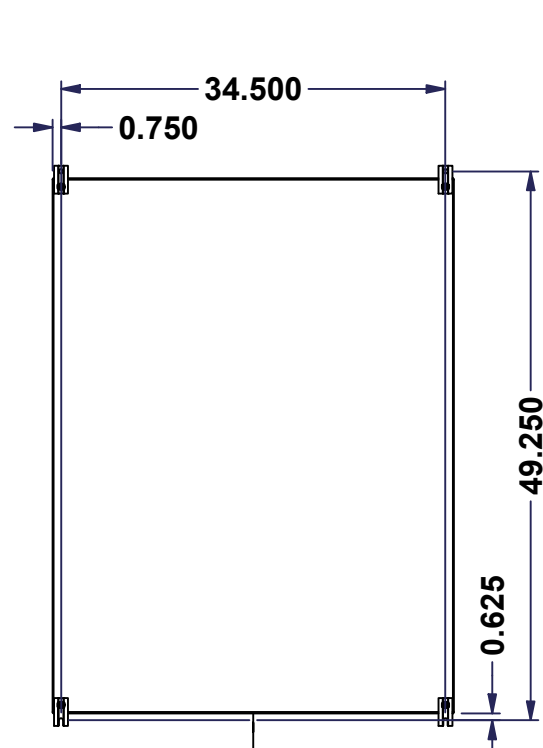

BACK

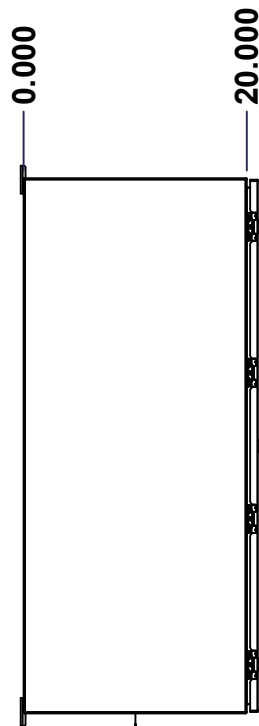

LEFT

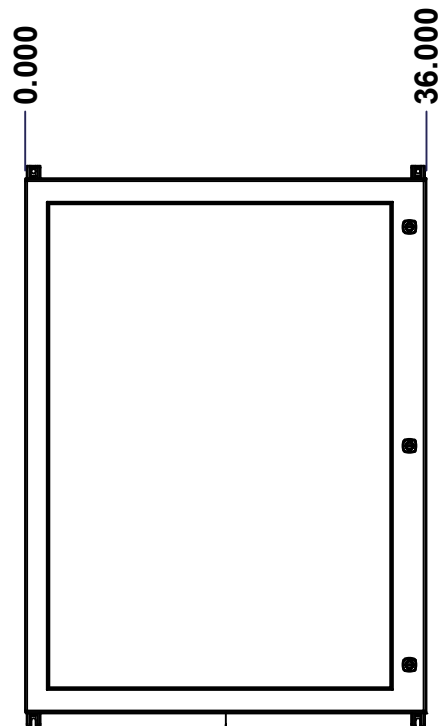

FRONT

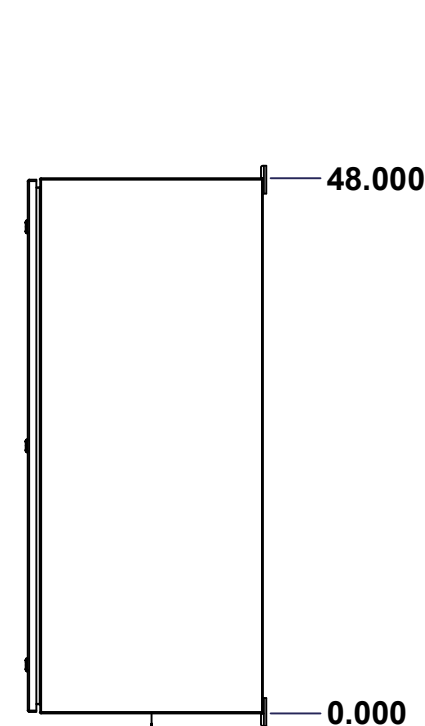

RIGHT



BOTTOM

No.	Revisions	Date	By/Par

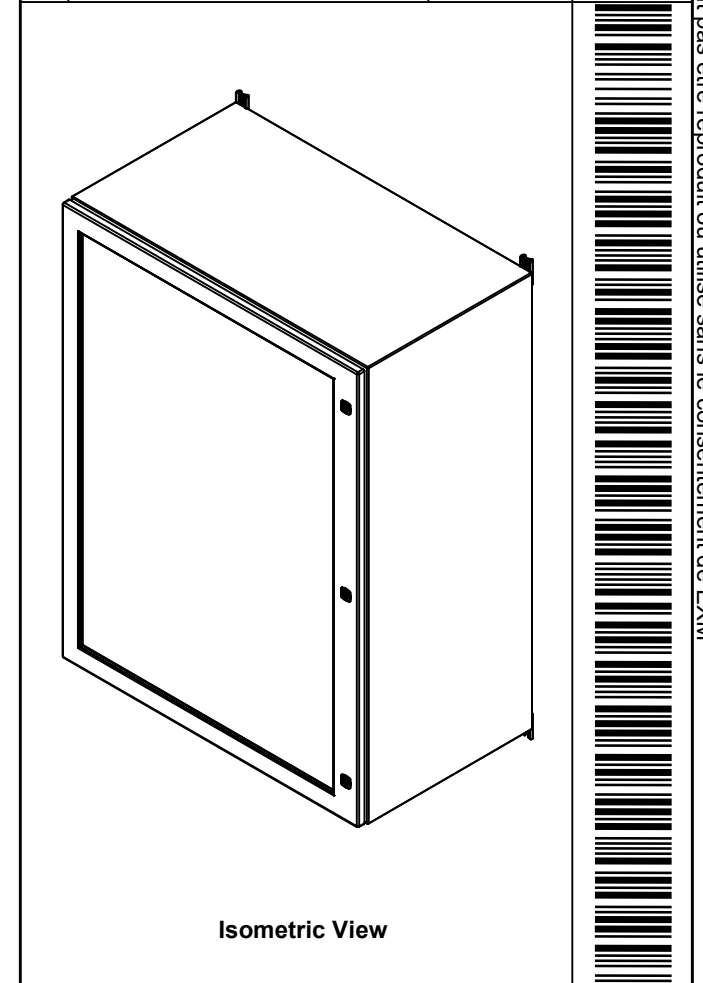

Isometric View



**GRAIN DIRECTION:
TOP/BOTTOM: HORIZONTAL
LEFT/RIGHT/BACK/FRONT: VERTICAL**

Tél: (450) 979-4373 Fax: (450) 979-4626 www.exmweb.com		Flatness Aplatissement Max 3.0mm Projection
Customer Client	Date	
Drawn By Dessiné Par	BoxCad: BoxCad	Date 06-Jun-23
Material Matière	14 Ga Stainless Steel 304 (1.7mm)	
Color Couleur	Unpainted	Finish Fini Brushed
Description	Detail Rev.	
5412ESSW 48" x 36" x 20" Assembly		
Part Number Numéro Pièce	Rev. 0	1 / 15

SEE BILL OF MATERIAL ON LAST PAGE

5412ESSW483620THNOIP

This drawing is confidential and must not be reproduced or used without the consent of EXM

Ce dessin est confidentiel et ne doit pas être reproduit ou utilisé sans le consentement de EXM

NOTE	
ITEM	DESCRIPTION
1	NEMA 4X Enclosure
2	C/W Standard ground studs on box and cover
3	W/O Standard door stiffener
4	W/O Inner panel
5	C/W Standard inner panel mounting studs
6	C/W 885 ESMF4_CLOSE Sold separately (Installed)
7	C/W 885 ESMF4_OPEN Sold separately (Installed)
8	C/W R5 Insulation (Installed by EXM)

No.	Revisions	Date	By/Par

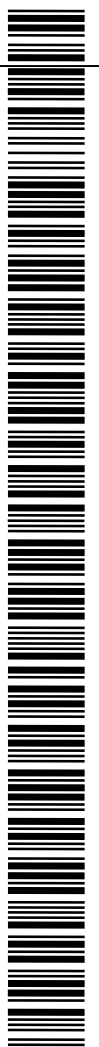
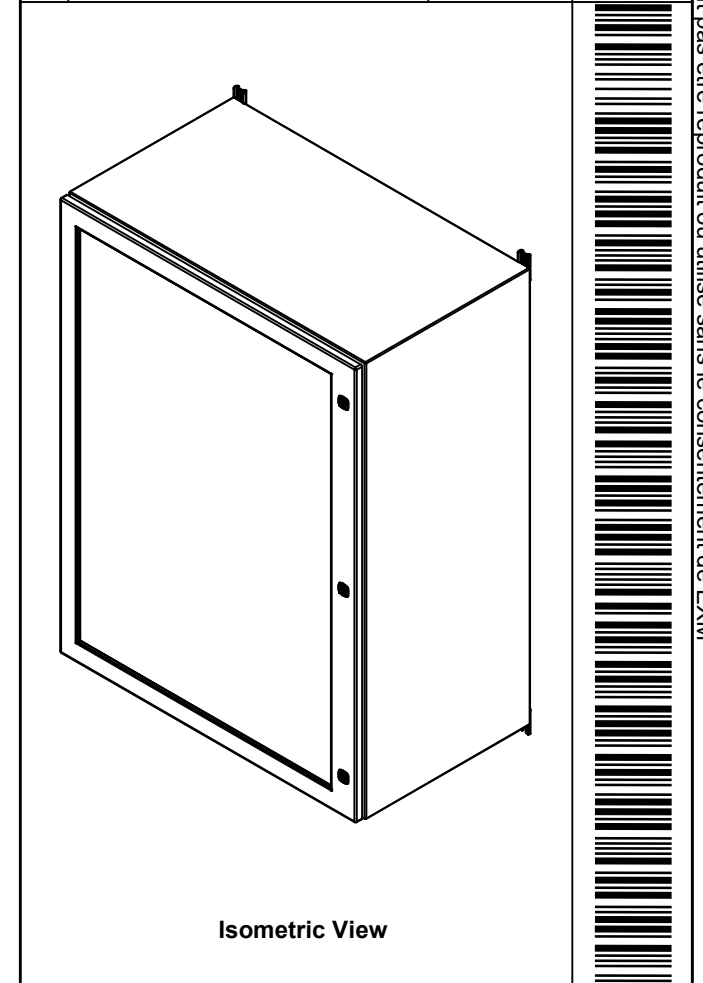

PACKING		
ITEM	QTY	DESCRIPTION
Cardboard sleeve	2	Top and Bottom
Cardboard strip	2	Between back of enclosure and inner panel
Plastic bag	1	To protect cover surface and inside gasket
Cardboard corner	4	To reinforced for the plastic strap tightening
Plastic strap - Black	2	To Squeeze the 2 cardboard sleeve together
Packaging label	3	White label with PN
Plastic strap- Green	2	To secure the enclosure to the wood pallet
Wood Pallet	1	2" deeper and 3" larger than enclosure size

8	STK-Q-00600	2	M12 to M8 Adaptor
1	STK-K-01800	5	5412 ES Accessory Kit
1	5412ESSW483620THNOI PC	0	5412ESSW 48" x 36" Cover
1	5412ESSW483620THNOI PB	0	5412ESSW 48" x 36" x 20" Body
4	STK-Q-04051-08	1	M6 x 8mm Stainless Steel Hexagon Socket Head Machine Screw with Nyseal
Qty	Part Number	Rev	Description
Parts List			

<p>Tél: (450) 979-4373 Fax: (450) 979-4626 www.exmweb.com</p>	Flatness Aplatissement Max 3.0mm
	Projection
Customer Client	Date
Drawn By Dessiné Par BoxCad: BoxCad	Date 06-Jun-23
Material Matière	14 Ga Stainless Steel 304 (1.7mm)
Color Couleur	Unpainted
Finish Fini	Brushed
Description	Detail Rev.
5412ESSW 48" x 36" x 20" Assembly	
Part Number Numéro Pièce	Rev. 2
5412ESSW483620THNOIP	0
	15

This drawing is confidential and must not be reproduced or used without the consent of EXM

Ce dessin est confidentiel et ne doit pas être reproduit ou utilisé sans le consentement de EXM

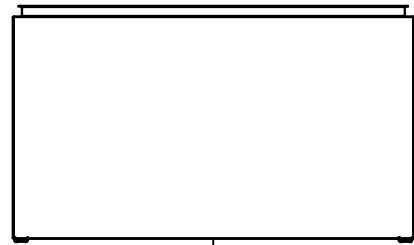

TOP

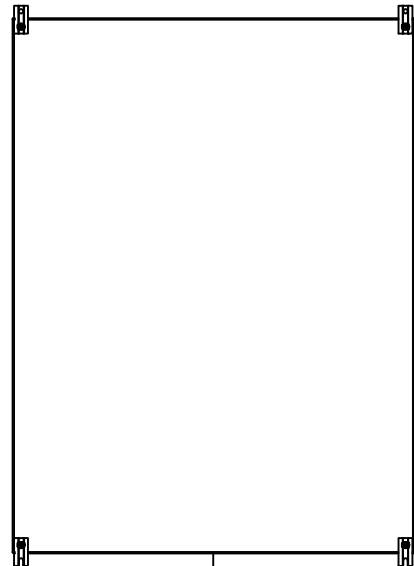

BACK

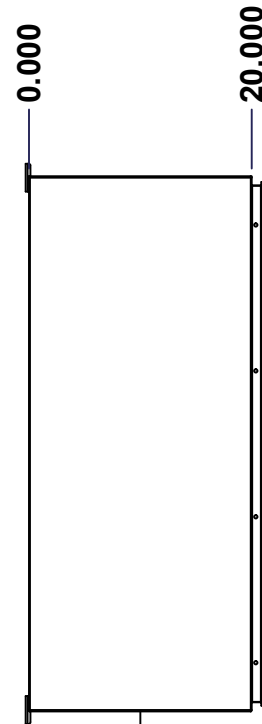

LEFT

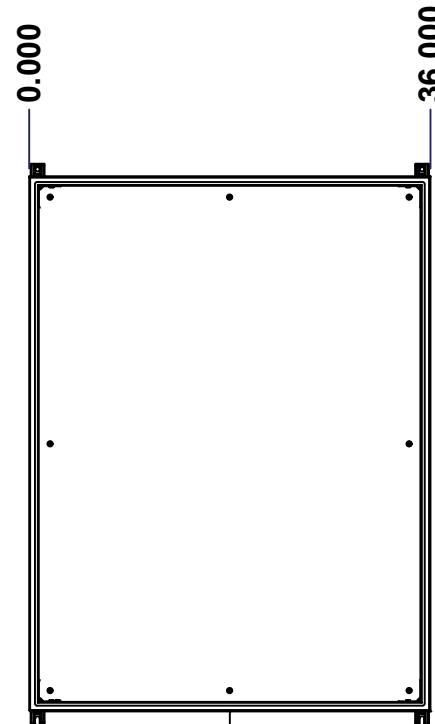

FRONT

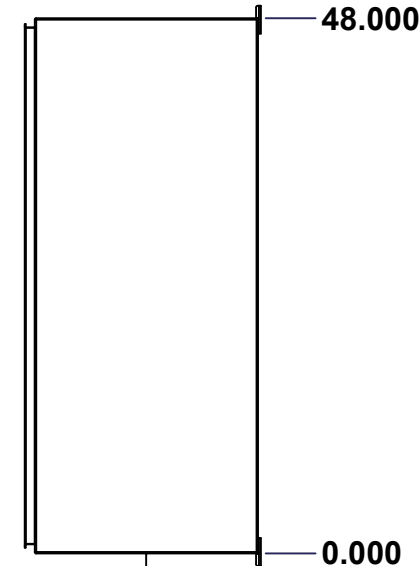

RIGHT

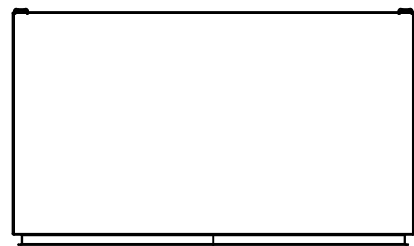

BOTTOM

No.	Revisions	Date	By/Par

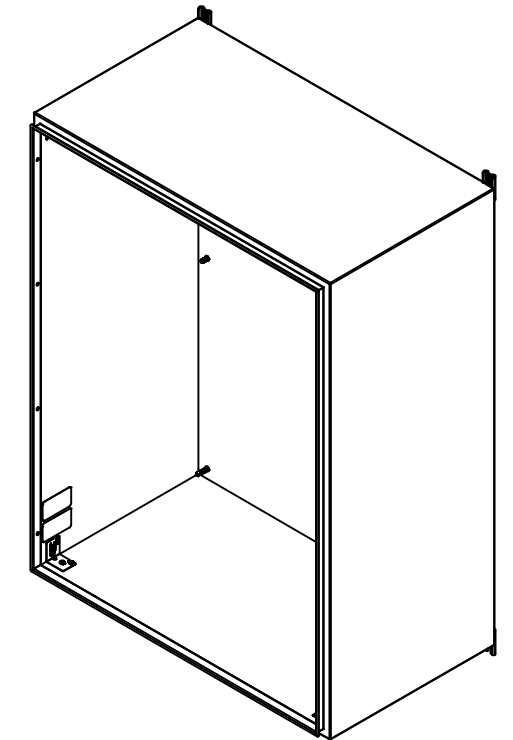

Isometric View



Tél: (450) 979-4373
 Fax: (450) 979-4626
www.exmweb.com

Flatness
Aplatissement

Max 3.0mm

Projection

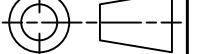

Customer Client	Date
Drawn By Dessiné Par BoxCad: BoxCad	Date 06-Jun-23
Material Matière 14 Ga Stainless Steel 304 (1.7mm)	
Color Couleur Unpainted	Finish Fini Brushed
Description 5412ESSW 48" x 36" x 20" Body	Detail Rev.

Part Number Numéro Pièce	Rev.	3
SEE BILL OF MATERIAL ON LAST PAGE 5412ESSW483620THNOIPB	0	15

This drawing is confidential and must not be reproduced or used without the consent of EXM

Ce dessin est confidentiel et ne doit pas être reproduit ou utilisé sans le consentement de EXM

STANDARD FEATURES ARE NOT LISTED IN THIS HOLE TABLE			
HOLE TABLE - TOP VIEW (CUSTOM FEATURE ONLY)			
CUT-OUT	XDIM	YDIM	DESCRIPTION
1	2.000	18.500	INSUL. STUD M6 x 18mm (Inside)
2	34.000	18.500	INSUL. STUD M6 x 18mm (Inside)

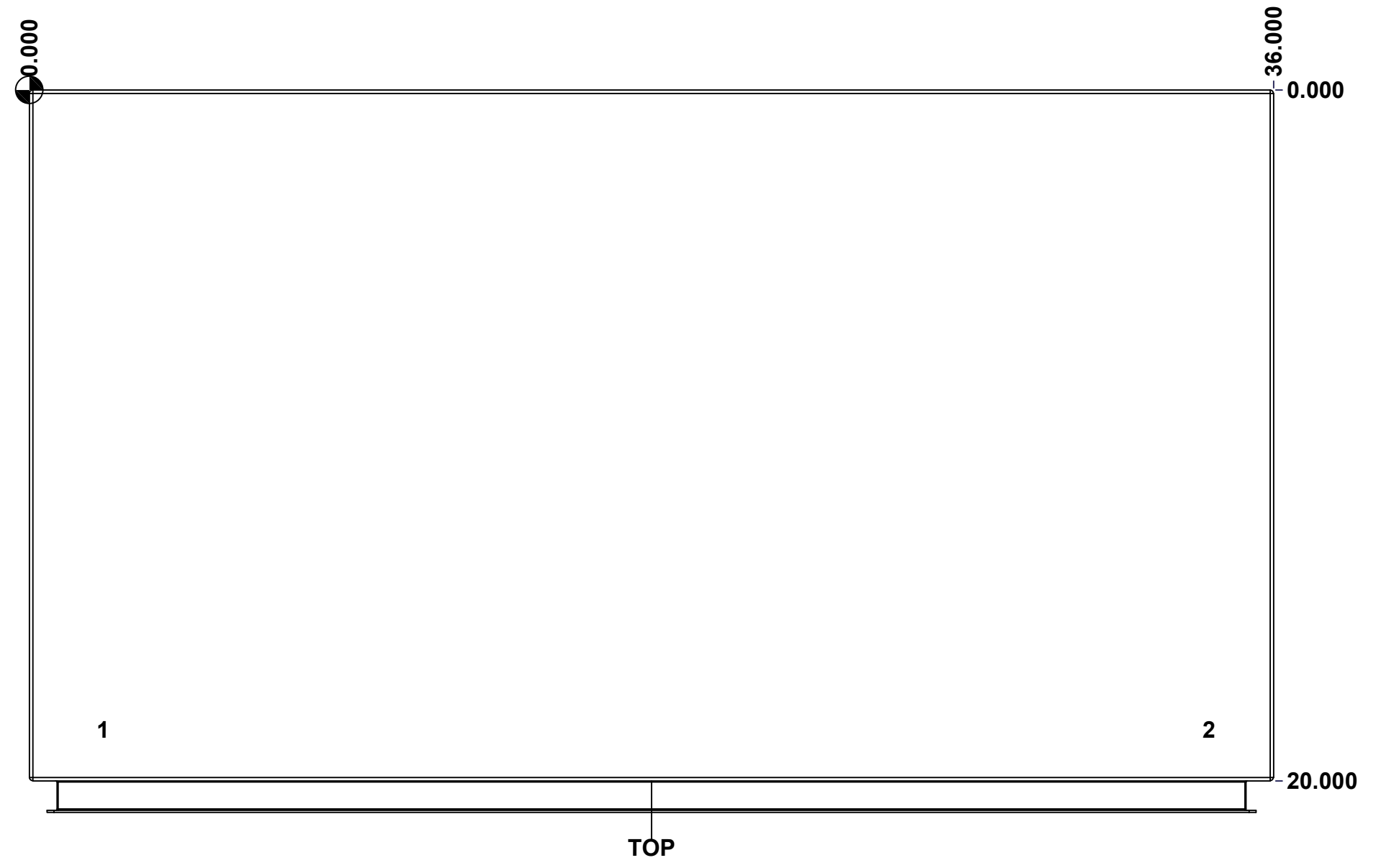

	Description	Status	
	5412ESSW 48" x 36" x 20" Body	(NULL)	
	Part Number Numéro Pièce	Rev.	4
	5412ESSW483620THNOIPB	0	15

This drawing is confidential and must not be reproduced or used without the consent of EXM

Ce dessin est confidentiel et ne doit pas être reproduit ou utilisé sans le consentement de EXM

STANDARD FEATURES ARE NOT LISTED IN THIS HOLE TABLE			
HOLE TABLE - BOTTOM VIEW (CUSTOM FEATURE ONLY)			
CUT-OUT	XDIM	YDIM	DESCRIPTION
1	2.000	18.500	INSUL. STUD M6 x 18mm (Inside)
2	34.000	18.500	INSUL. STUD M6 x 18mm (Inside)

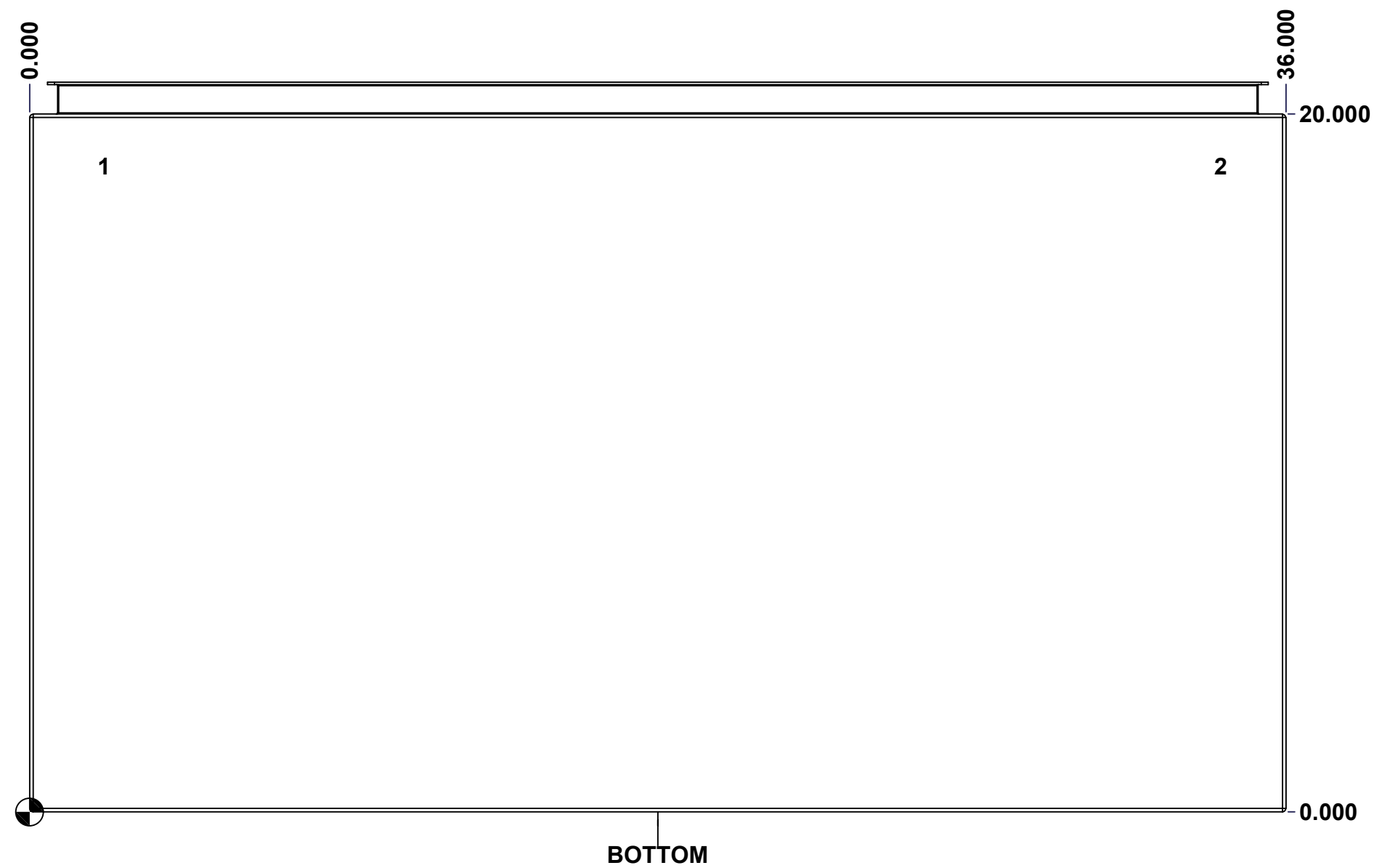

	Description	Status
	5412ESSW 48" x 36" x 20" Body	(NULL)
	Part Number Numéro Pièce	Rev.
	5412ESSW483620THNOIP	0
		5
		15

This drawing is confidential and must not be reproduced or used without the consent of EXM

Ce dessin est confidentiel et ne doit pas être reproduit ou utilisé sans le consentement de EXM

STANDARD FEATURES ARE NOT LISTED IN THIS HOLE TABLE

HOLE TABLE - BACK VIEW (CUSTOM FEATURE ONLY)

CUT-OUT	XDIM	YDIM	DESCRIPTION
1	1.875	1.875	IP STUD M8 x 35mm (Inside)
2	1.875	46.125	IP STUD M8 x 35mm (Inside)
3	34.125	46.125	IP STUD M8 x 35mm (Inside)
4	34.125	1.875	IP STUD M8 x 35mm (Inside)
5	1.875	24.000	IP STUD M8 x 35mm (Inside)
6	34.125	24.000	IP STUD M8 x 35mm (Inside)
7	18.000	1.875	IP STUD M8 x 35mm (Inside)
8	18.000	46.125	IP STUD M8 x 35mm (Inside)

9	35.250	48.000	FOOT 885 ESMF4_CLOSE
10	0.750	48.000	FOOT 885 ESMF4_CLOSE
11	35.250	0.000	FOOT 885 ESMF4_OPEN
12	0.750	0.000	FOOT 885 ESMF4_OPEN

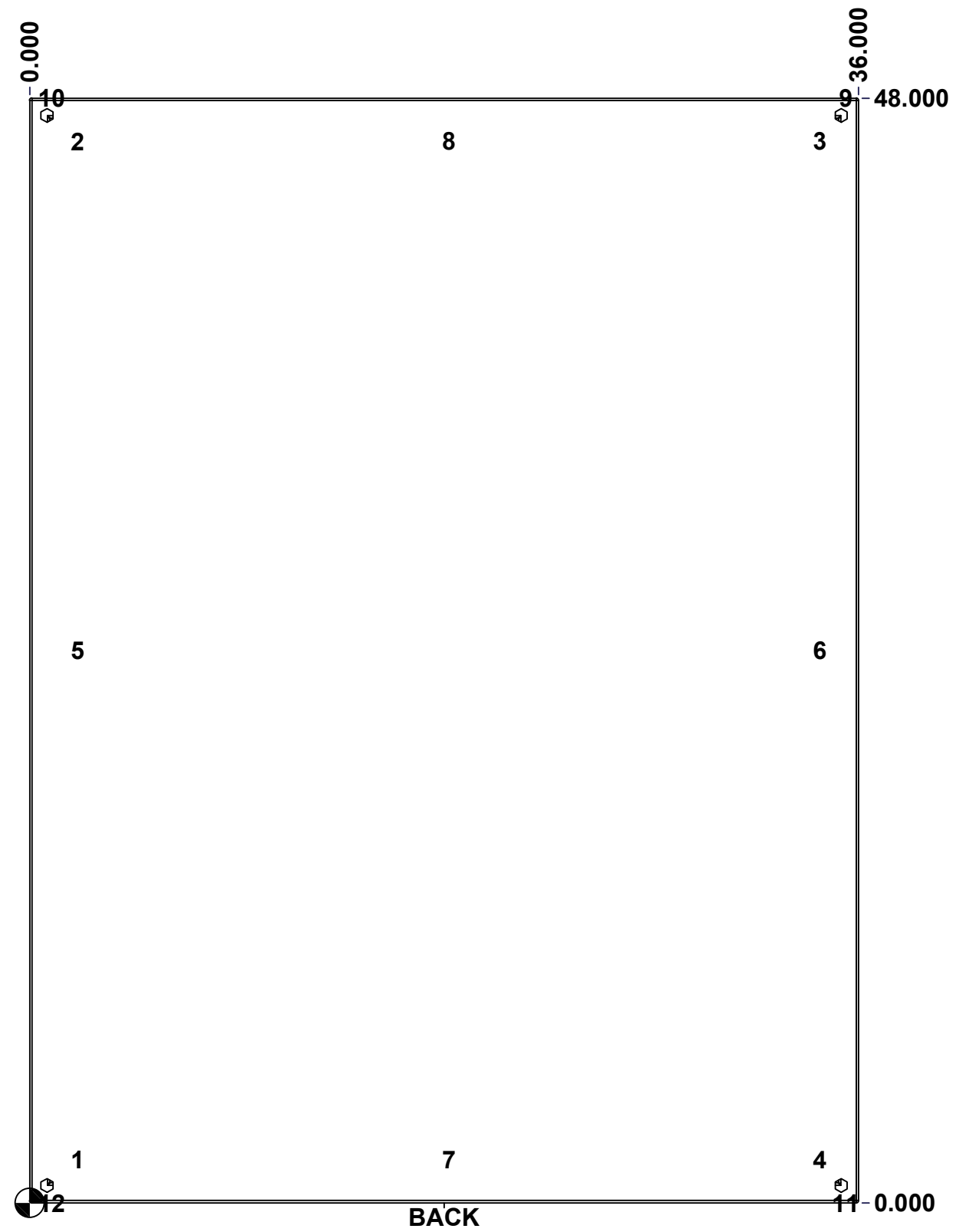

	Description	Status
	5412ESSW 48" x 36" x 20" Body	(NULL)
Part Number Numéro Pièce	5412ESSW483620THNOIP	Rev. 6
	0	15

This drawing is confidential and must not be reproduced or used without the consent of EXM

Ce dessin est confidentiel et ne doit pas être reproduit ou utilisé sans le consentement de EXM

No.	Revisions	Date	By/Par

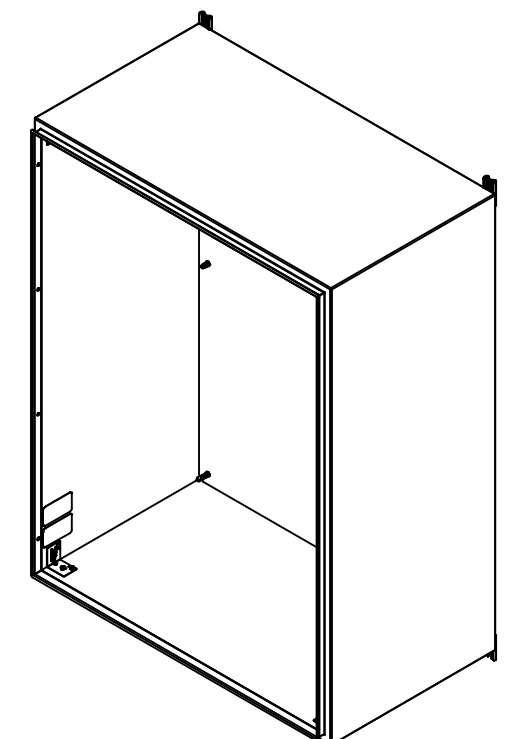



Isometric View



2	885ESMF4-FEET-A	0	885 ESMF4 Stainless Steel Mounting Foot (Opened Slot)
4	RIVET_NUT_SS_M10_FH_CE	0	Stainless Steel Rivet Nut M10 (Low Profile Close End)
4	STK-Q-06670	2	M10 x 16mm Stainless Steel Machine Screw
2	885ESMF4-FEET	0	885 ESMF4 Stainless Steel Mounting Foot
2	STK-S-00100	0	3.5" x 2" Silver Milar Flexcon Sticker
1	STK-K-70554	3	5412 ESTH Accessory Kit
1	5412ESSW483620THNOI-PI-RS	0	5412ESSW 48" x 36" Right Insulation
1	5412ESSW483620THNOI-PI-LS	0	5412ESSW 48" x 36" Left Insulation
1	5412ESSW483620THNOI-PI-BT	0	5412ESSW 48" x 36" Top and Bottom Insulation
1	5412ESSW483620THNOI-PI-TP	0	5412ESSW 48" x 36" Top and Bottom Insulation
1	5412ESSW483620THNOI-PI-B	0	5412ESSW 48" x 36" Back Insulation
4	STK-Q-16070	1	Stud M6 x 18mm Stainless steel
8	STK-Q-16020	1	Stud M8 x 35mm Stainless Steel
1	5412ESSW483620THNOI-PB-P	0	5412ESSW 48" x 36" x 20" Body Part

Qty	Part Number	Rev	Description
Parts List			

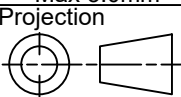
 Tél: (450) 979-4373 Fax: (450) 979-4626 www.exmweb.com		Flatness Aplatissement  Max 3.0mm
Customer Client Drawn By Dessiné Par BoxCad: BoxCad		Date Date 06-Jun-23
Material Matière 14 Ga Stainless Steel 304 (1.7mm)		Projection 
Color Couleur Unpainted	Finish Fini Brushed	
Description 5412ESSW 48" x 36" x 20" Body		Detail Rev.
Part Number Numéro Pièce 5412ESSW483620THNOIPB		Rev. 7 0

This drawing is confidential and must not be reproduced or used without the consent of EXM

Ce dessin est confidentiel et ne doit pas être reproduit ou utilisé sans le consentement de EXM

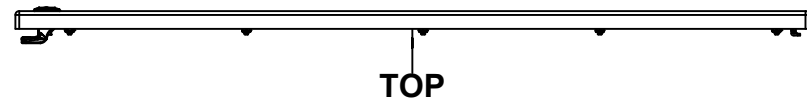

TOP

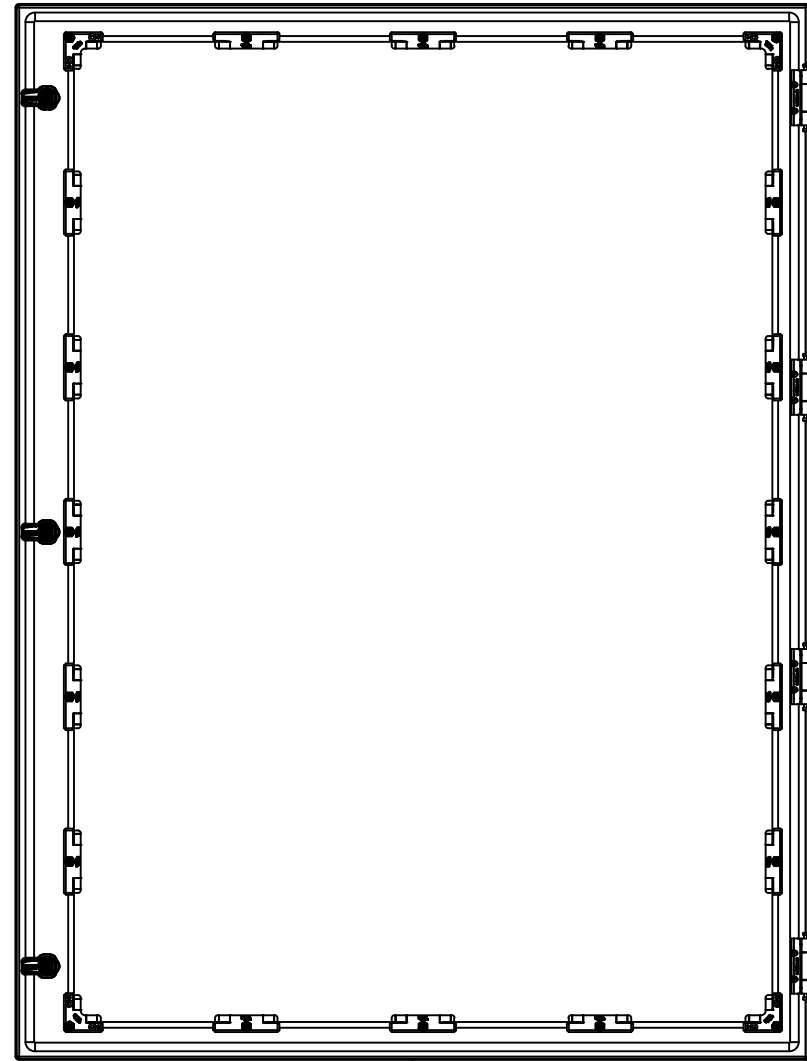

BACK

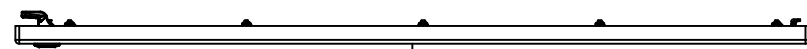

BOTTOM

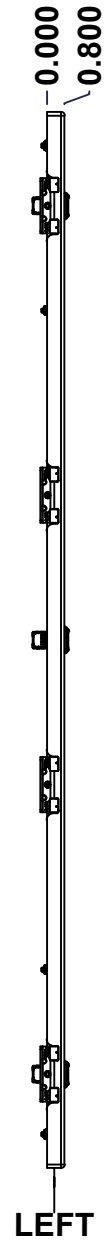

LEFT

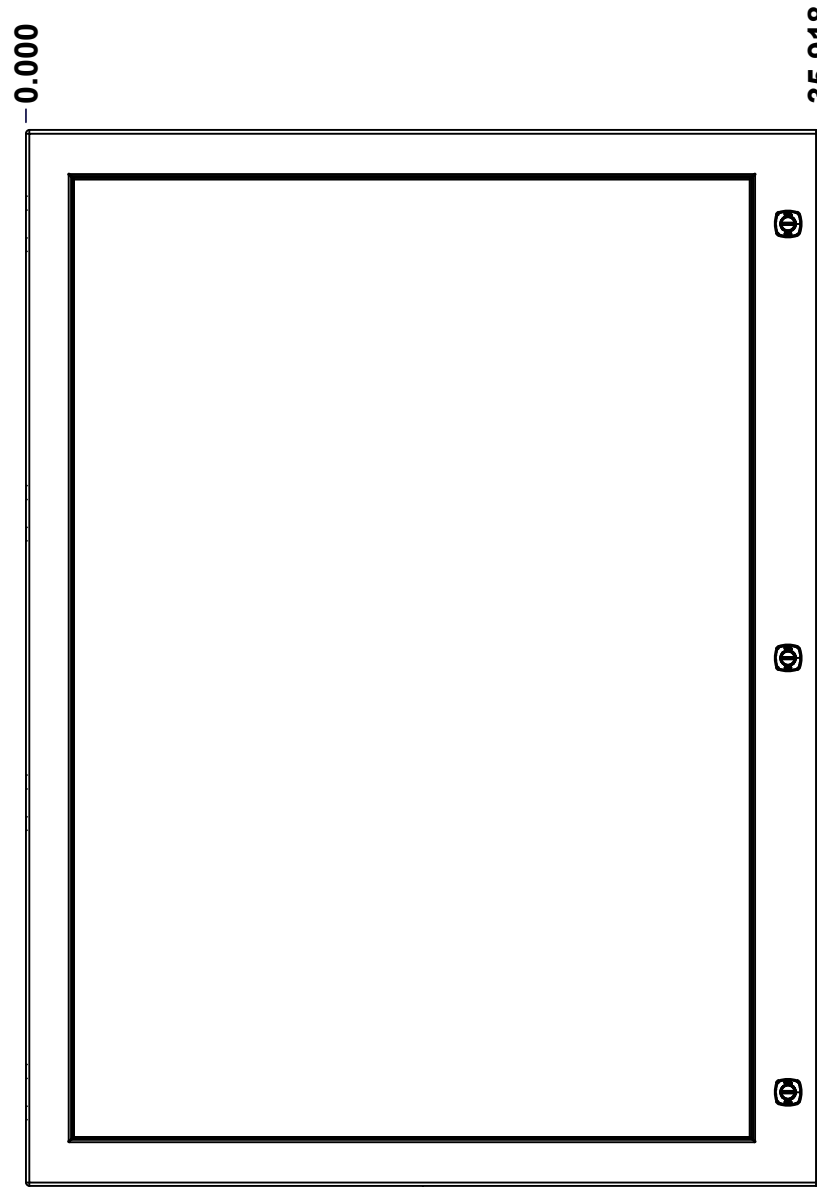

FRONT

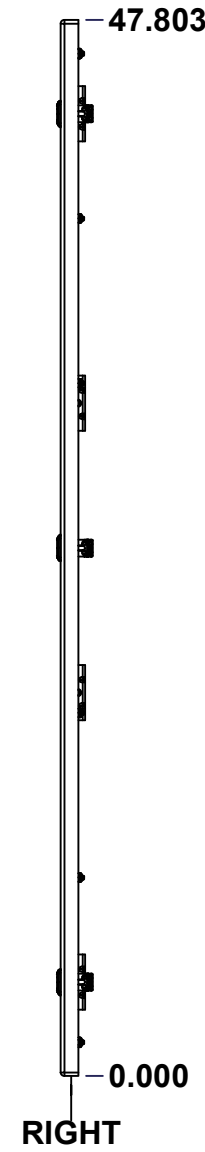

RIGHT

No.	Revisions	Date	By/Par

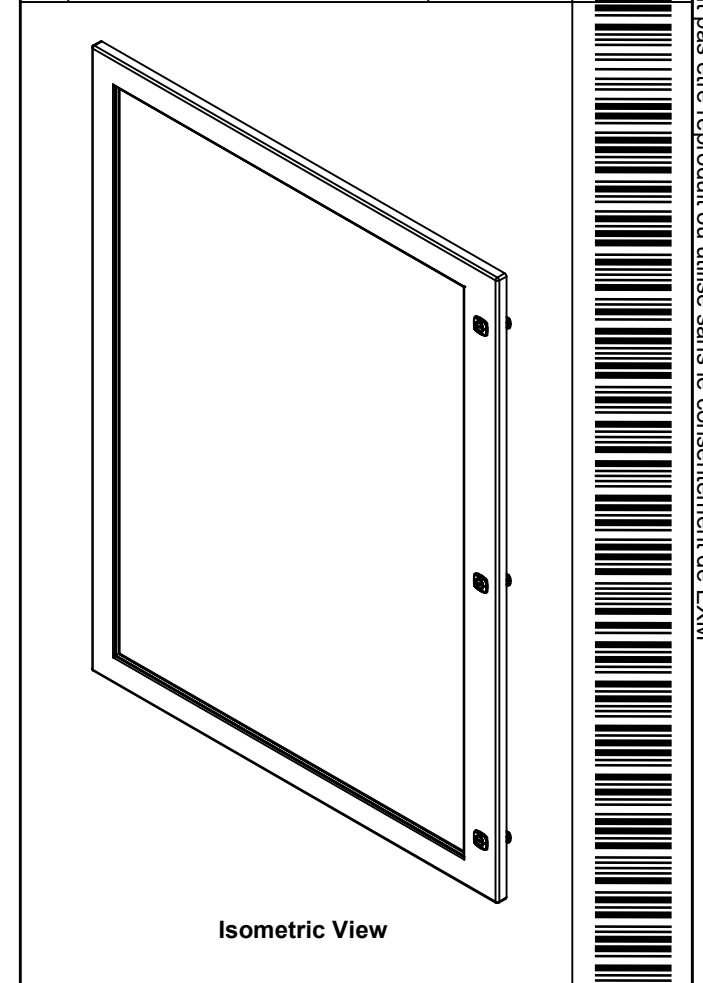

Isometric View



		Tél: (450) 979-4373 Fax: (450) 979-4626 www.exmweb.com		Flatness Aplatissement Max 3.0mm Projection
Customer Client		Date		
Drawn By Dessiné Par		BoxCad: BoxCad		Date 06-Jun-23
Material Matière		14 Ga Stainless Steel 304 (1.7mm)		
Color Couleur	Unpainted	Finish Fini	Brushed	
Description			Detail Rev.	
5412ESSW 48" x 36" Cover				
Part Number Numéro Pièce		Rev.	8	
SEE BILL OF MATERIAL ON LAST PAGE		5412ESSW483620THNOIPC	0	15

This drawing is confidential and must not be reproduced or used without the consent of EXM

Ce dessin est confidentiel et ne doit pas être reproduit ou utilisé sans le consentement de EXM

STANDARD FEATURES ARE NOT LISTED IN THIS HOLE TABLE

HOLE TABLE - FRONT VIEW (CUSTOM FEATURE ONLY)

CUT-OUT	XDIM	YDIM	DESCRIPTION
1	1.469	8.985	STUD M6 x 18mm (Inside)
2	33.468	8.985	STUD M6 x 18mm (Inside)
3	1.469	16.443	STUD M6 x 18mm (Inside)
4	33.468	16.443	STUD M6 x 18mm (Inside)
5	1.469	23.902	STUD M6 x 18mm (Inside)
6	33.468	23.902	STUD M6 x 18mm (Inside)
7	1.469	31.360	STUD M6 x 18mm (Inside)
8	33.468	31.360	STUD M6 x 18mm (Inside)
9	1.469	38.818	STUD M6 x 18mm (Inside)
10	33.468	38.818	STUD M6 x 18mm (Inside)
11	1.469	46.276	STUD M6 x 18mm (Inside)
12	1.469	1.527	STUD M6 x 18mm (Inside)
13	9.469	46.276	STUD M6 x 18mm (Inside)
14	9.469	1.527	STUD M6 x 18mm (Inside)
15	17.469	46.276	STUD M6 x 18mm (Inside)
16	17.469	1.527	STUD M6 x 18mm (Inside)
17	25.468	46.276	STUD M6 x 18mm (Inside)
18	25.468	1.527	STUD M6 x 18mm (Inside)
19	33.468	46.276	STUD M6 x 18mm (Inside)
20	33.468	1.527	STUD M6 x 18mm (Inside)

21	34.494	43.553	880 SCQ4-SLSS6
22	34.494	23.902	880 SCQ4-SLSS6
23	34.494	4.250	880 SCQ4-SLSS6

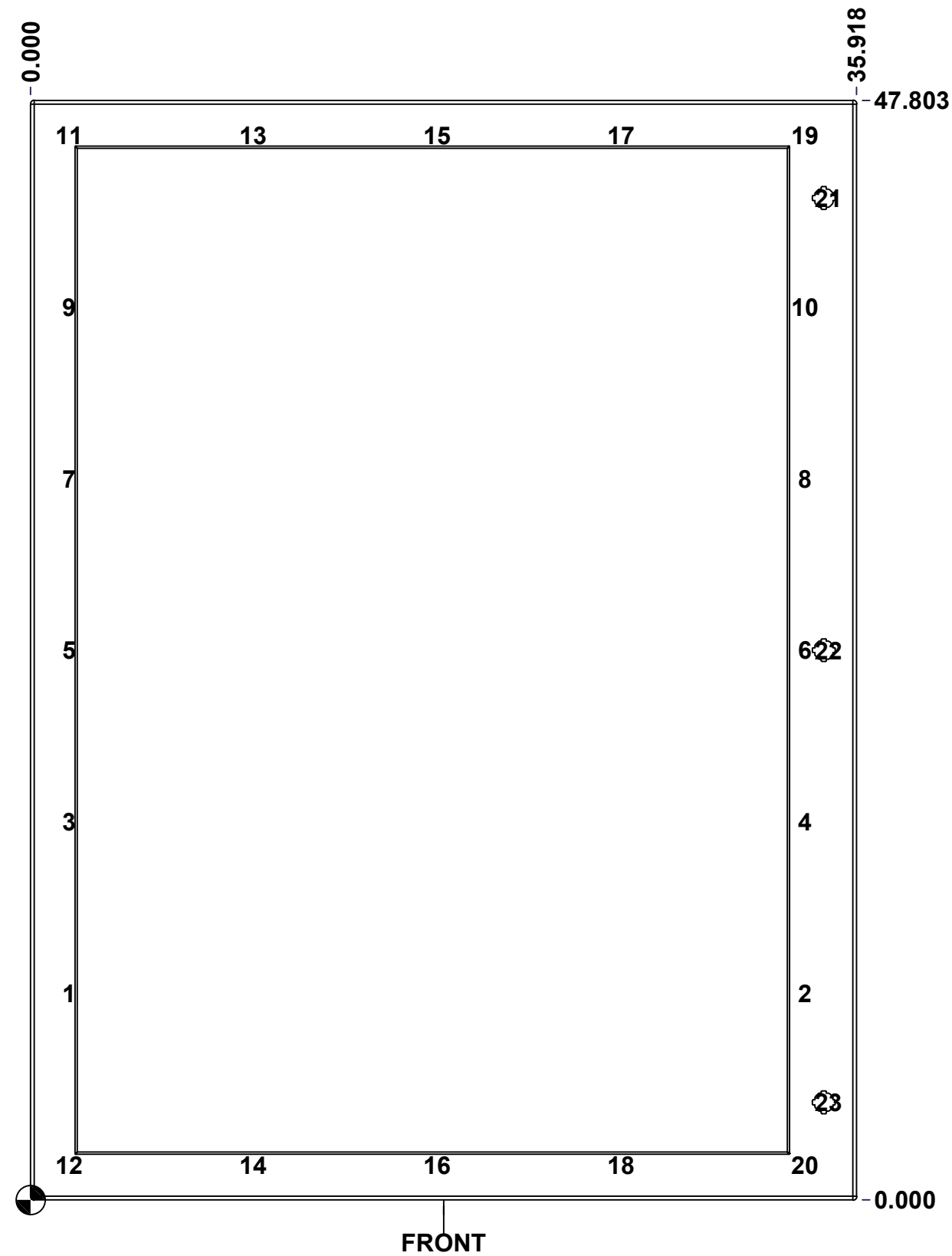

	Description	Status
	5412ESSW 48" x 36" Cover	(NULL)
	Part Number	Rev.
	5412ESSW483620THNOIPC	9
		0
		15

This drawing is confidential and must not be reproduced or used without the consent of EXM

Ce dessin est confidentiel et ne doit pas être reproduit ou utilisé sans le consentement de EXM

No.	Revisions	Date	By/Par

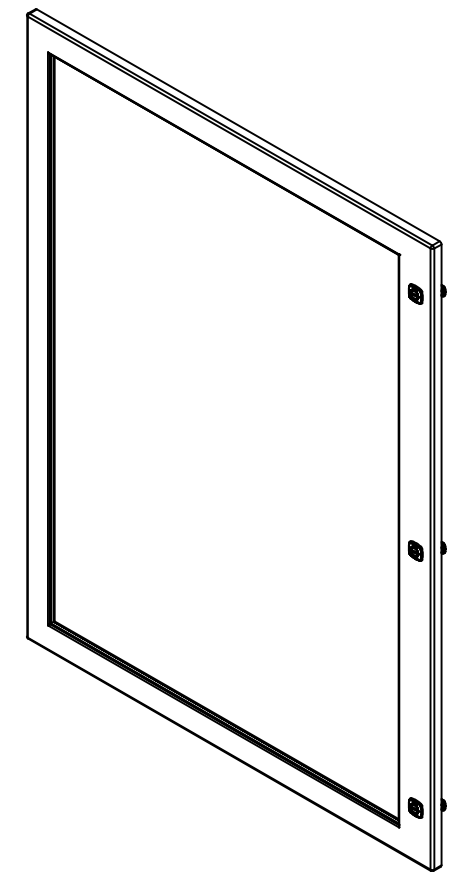

Isometric View

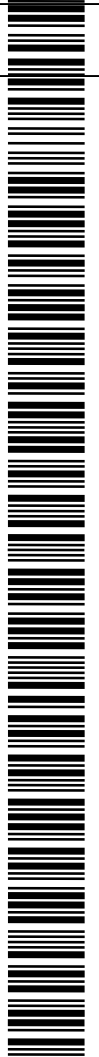

QTY	Part Number	Rev	Description
16	STK-Q-60701	2.1	880 WK - Lexan 1/4" Fixing Bracket
1	STK-A-60703	0	5412 ESW Lexan Bracket Kit
20	STK-Q-16053	1	Stud M6 x 23mm Stainless steel
1	STK-G-02710	0	880 HWKG - Windows Kit Gasket
1	5412ESSW483620THNOI PLXG	0	5412ESSW 48" x 36" Lexan Gasket Part
1	5412ESSW483620THNOI PLX	0	5412ESSW 44.375" x 32.125" Lexan Part
1	5412ESSW483620THNOI PG	0	5412ESSW 48" x 36" Cover Gasket Part
1	5412ESSW483620THNOI PC-P	0	5412ESSW 48" x 36" Cover Part
3	880 SCQ4-SLSS6	7	5412 ESS 1/4 Turn Lock
4	STK-A-33016	0	5412 ESS Bended Hinge (Body Part)
Parts List			

	Tél: (450) 979-4373 Fax: (450) 979-4626 www.exmweb.com	Flatness Aplatissement Max 3.0mm
	Projection 	Customer Client Date
Drawn By Dessiné Par BoxCad: BoxCad	Date 06-Jun-23	Material Matière 14 Ga Stainless Steel 304 (1.7mm)
Color Couleur Unpainted	Finish Fini Brushed	Description 5412ESSW 48" x 36" Cover Detail Rev.
Part Number Numéro Pièce 5412ESSW483620THNOIPC	Rev. 0	10 15

This drawing is confidential and must not be reproduced or used without the consent of EXM

Ce dessin est confidentiel et ne doit pas être reproduit ou utilisé sans le consentement de EXM

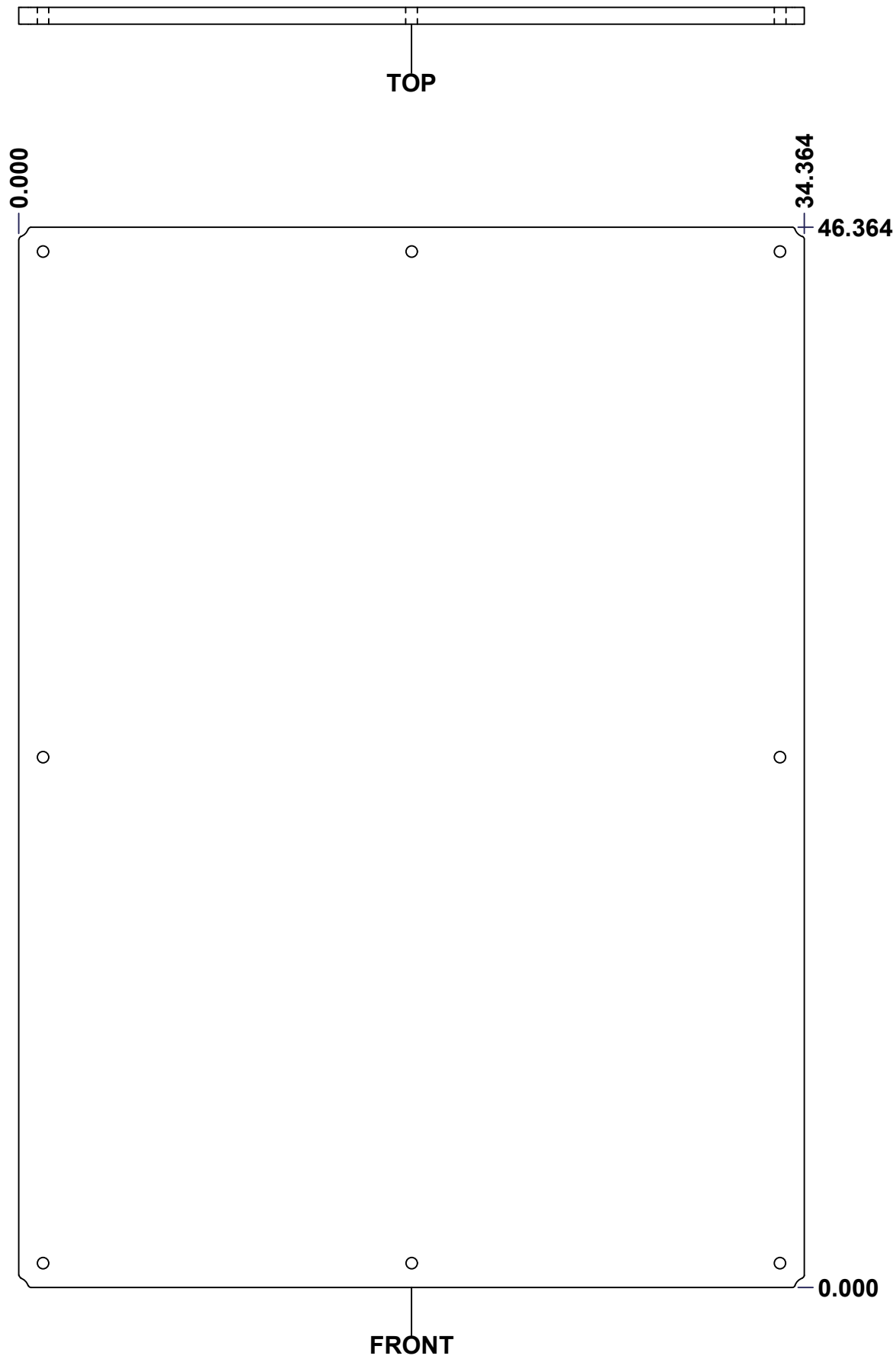

No.	Revisions	Date	By/Par

Isometric View

Tél: (450) 979-4373 Fax: (450) 979-4626 www.exmweb.com		Flatness Aplatissement Max 3.0mm
Customer Client		Projection
Drawn By / Dessiné Par: BoxCad: Patrick Deschenes		Date: 23-Jan-07
Material / Matière: Polyisocyanurate		
Color / Couleur: Aluminum	Finish / Fini: N/A	
Description: 5412ESSW 48" x 36" Back Insulation		Detail Rev.
Part Number / Numéro Pièce: 5412ESSW483620THNOIP-B		Rev. 11

This drawing is confidential and must not be reproduced or used without the consent of EXM

Ce dessin est confidentiel et ne doit pas être reproduit ou utilisé sans le consentement de EXM

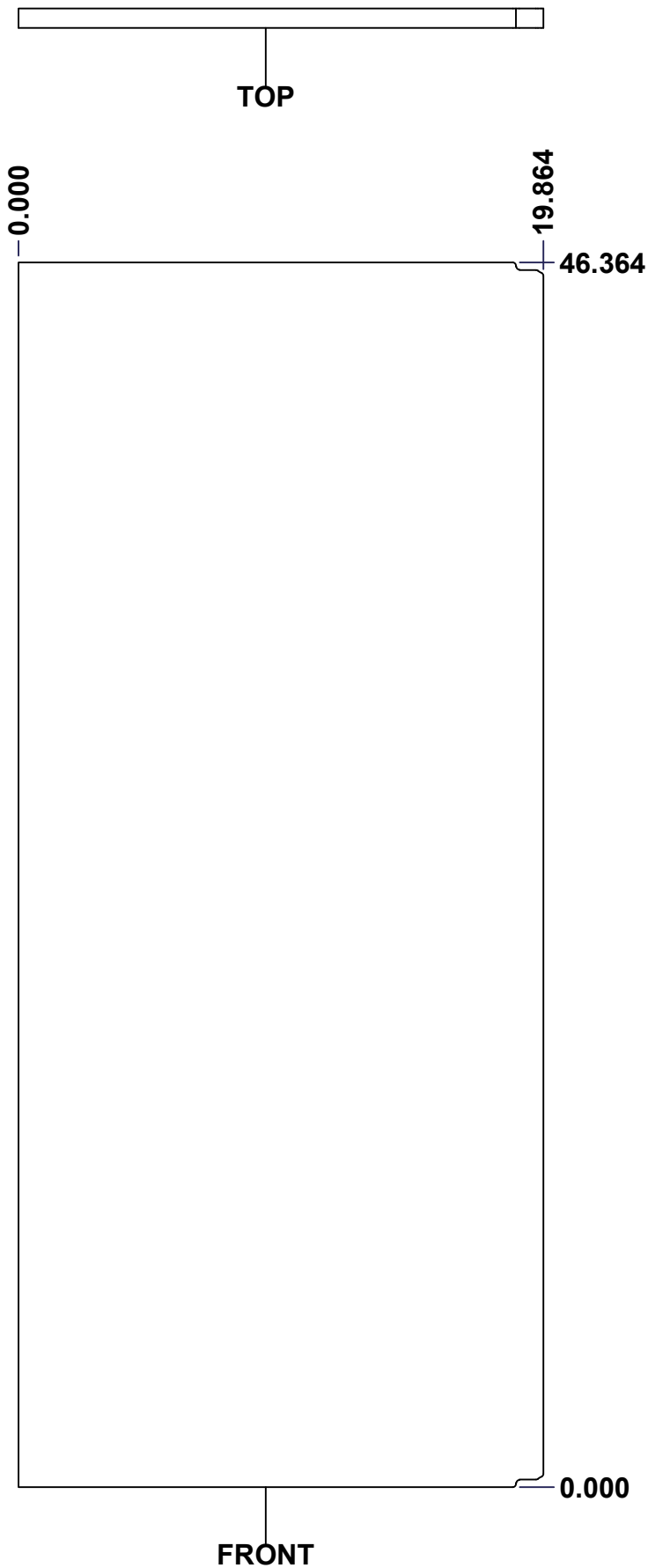

No.	Revisions	Date	By/Par

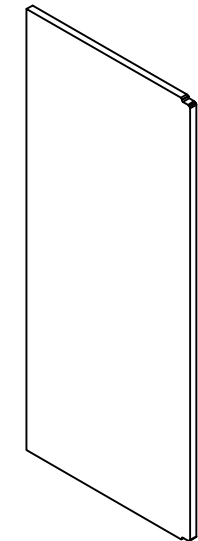

Isometric View

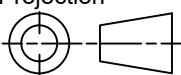

 Tél: (450) 979-4373 Fax: (450) 979-4626 www.exmweb.com		Flatness Aplatissement Max 3.0mm
Projection 		Date 23-Jan-07
Customer Client	Date	
Drawn By / Dessiné Par: BoxCad: Patrick Deschenes	Date: 23-Jan-07	
Material / Matière: Polyisocyanurate	Date	
Color / Couleur: Aluminum	Finish / Fini: N/A	Date
Description: 5412ESSW 48" x 36" Left Insulation		Detail Rev.
Part Number / Numéro Pièce: 5412ESSW483620THNOI-LS	Rev.:	12

SEE BILL OF MATERIAL ON LAST PAGE 5412ESSW483620THNOI-LS 0 15

This drawing is confidential and must not be reproduced or used without the consent of EXM

Ce dessin est confidentiel et ne doit pas être reproduit ou utilisé sans le consentement de EXM

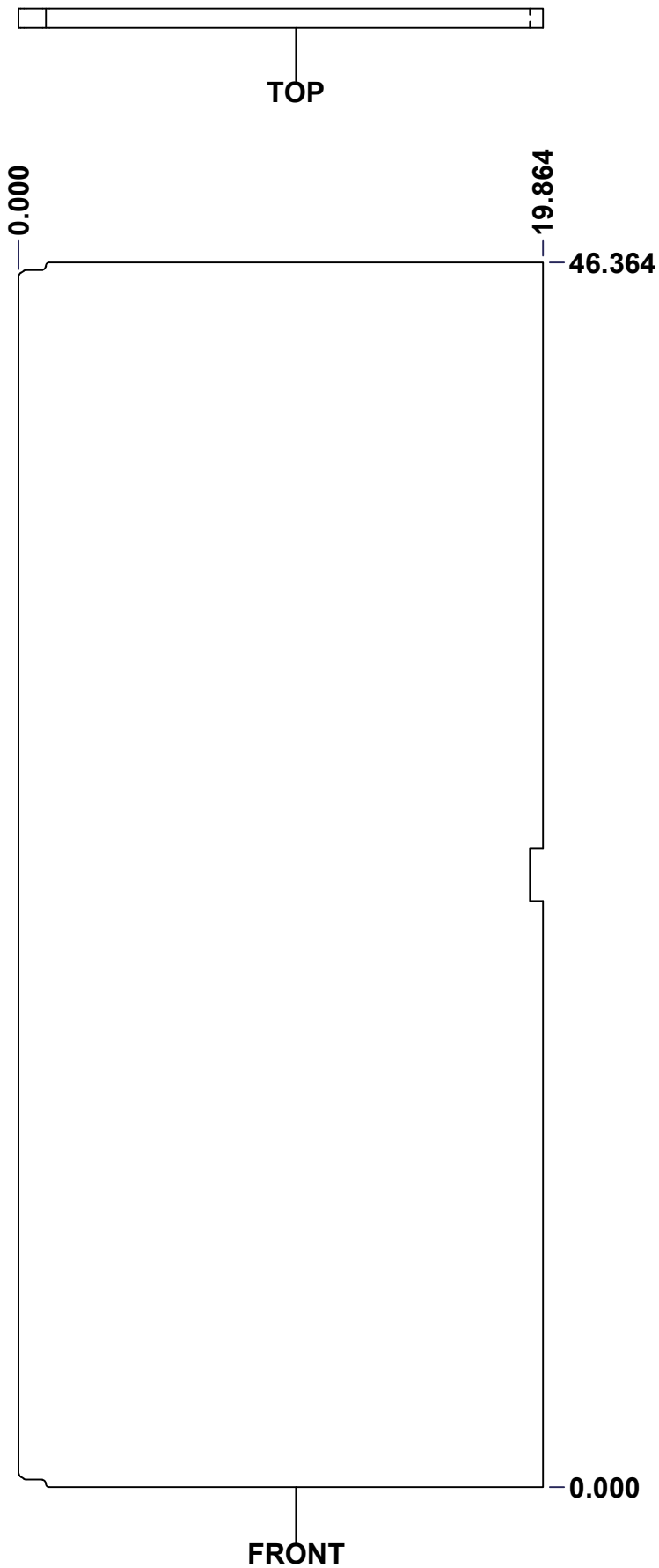

No.	Revisions	Date	By/Par

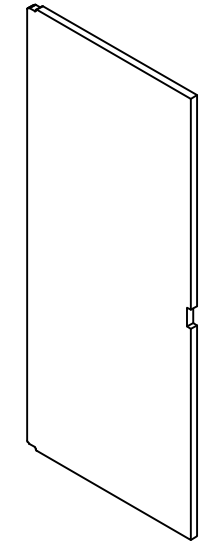

Isometric View

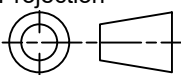

 Tél: (450) 979-4373 Fax: (450) 979-4626 www.exmweb.com		Flatness Aplatissement Max 3.0mm
Projection 		Date 23-Jan-07
Customer Client	Date	
Drawn By Dessiné Par	BoxCad: Patrick Deschenes	Date 23-Jan-07
Material Matière	Polyisocyanurate	
Color Couleur	Aluminum	Finish Fini N/A
Description	Detail Rev.	
5412ESSW 48" x 36" Right Insulation		
Part Number Numéro Pièce	Rev.	13
SEE BILL OF MATERIAL ON LAST PAGE 5412ESSW483620THNOIPI-RS 0		15

This drawing is confidential and must not be reproduced or used without the consent of EXM

Ce dessin est confidentiel et ne doit pas être reproduit ou utilisé sans le consentement de EXM



TOP



FRONT



RIGHT

No.	Revisions	Date	By/Par

Isometric View

Tél: (450) 979-4373 Fax: (450) 979-4626 www.exmweb.com		Flatness Aplatissement Max 3.0mm
Customer Client		Date
Drawn By / Dessiné Par: BoxCad: Patrick Deschenes		Date: 23-Jan-07
Material / Matière: Polyisocyanurate		
Color / Couleur: Aluminum	Finish / Fini: N/A	
Description: 5412ESSW 48" x 36" Top and Bottom Insulation		Detail Rev.
Part Number / Numéro Pièce		Rev. 14

SEE BILL OF MATERIAL ON LAST PAGE 5412ESSW483620THNOIPI-TP 0

This drawing is confidential and must not be reproduced or used without the consent of EXM

Ce dessin est confidentiel et ne doit pas être reproduit ou utilisé sans le consentement de EXM

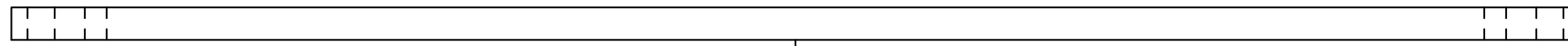

TOP



FRONT



RIGHT

No.	Revisions	Date	By/Par

Isometric View

Tél: (450) 979-4373 Fax: (450) 979-4626 www.exmweb.com		Flatness Aplatissement
		Max 3.0mm
Customer Client		Date
Drawn By Dessiné Par BoxCad: Patrick Deschenes		Date 23-Jan-07
Material Matière Polyisocyanurate		
Color Couleur Aluminum	Finish Fini N/A	
Description 5412ESSW 48" x 36" Top and Bottom Insulation		Detail Rev.
Part Number Numéro Pièce		Rev. 15

SEE BILL OF MATERIAL ON LAST PAGE 5412ESSW483620THNOIPI-BT 0