

This drawing is confidential and must not be reproduced or used without the consent of EXM

Ce dessin est confidentiel et ne doit pas être reproduit ou utilisé sans le consentement de EXM

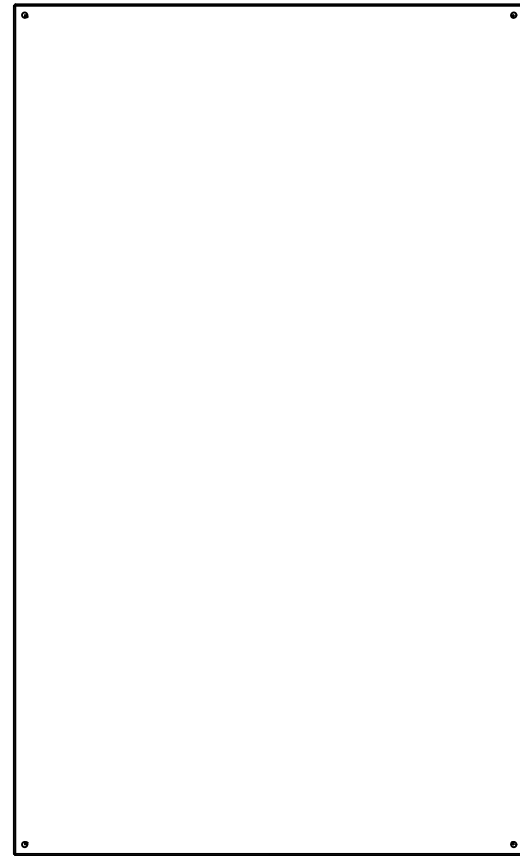

TOP



BACK



BOTTOM

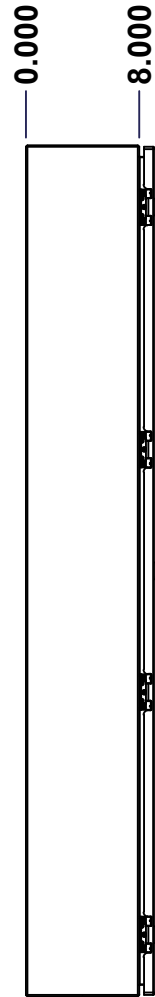

LEFT

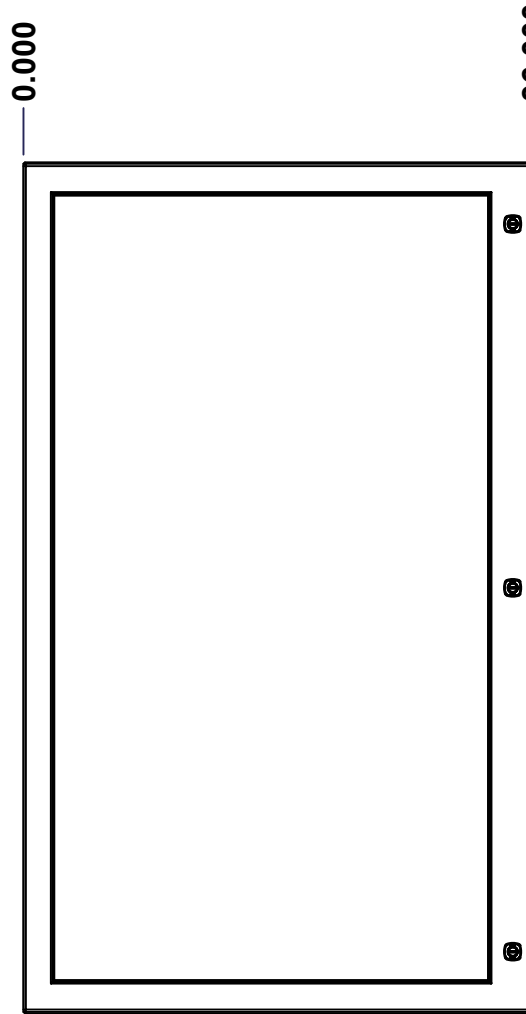

FRONT

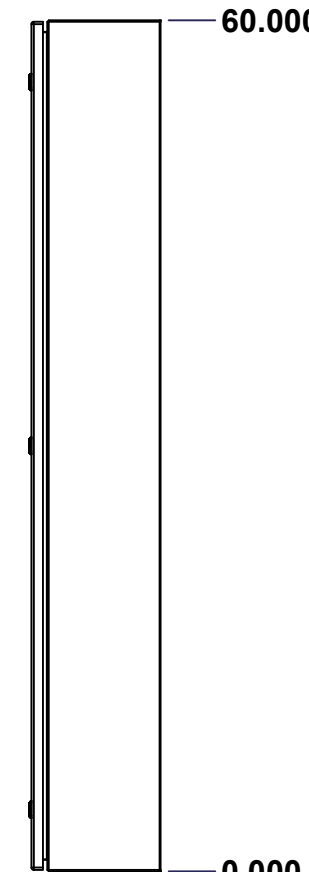

RIGHT

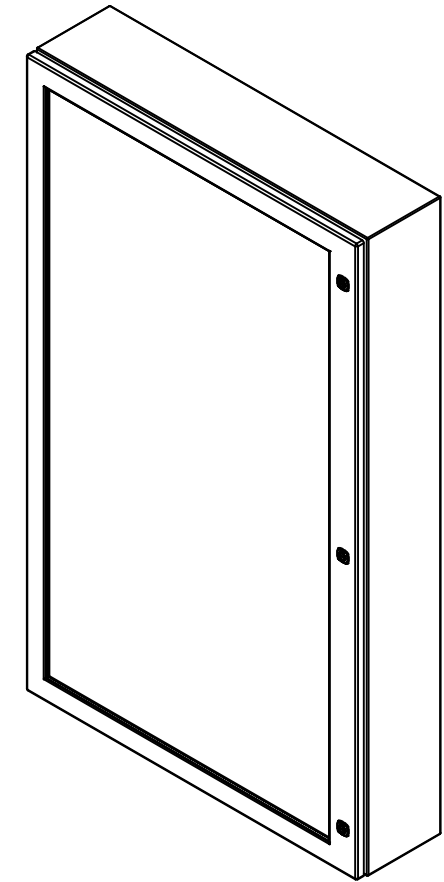

Isometric View



**GRAIN DIRECTION:
TOP/BOTTOM: HORIZONTAL
LEFT/RIGHT/BACK/FRONT: VERTICAL**

SEE BILL OF MATERIAL ON LAST PAGE

No.	Revisions	Date	By/Par

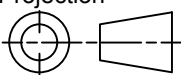
 Tél: (450) 979-4373 Fax: (450) 979-4626 www.exmweb.com		Flatness Aplatissement Max 3.0mm Projection 
Customer Client	Date	
Drawn By Dessiné Par	BoxCad: BoxCad	Date 21-Jun-23
Material Matière	14 Ga Stainless Steel 316 (1.7mm)	
Color Couleur	Unpainted	Finish Fini Brushed
Description	Detail Rev.	
5412ESSW 60" x 36" x 8" Assembly		
Part Number Numéro Pièce	Rev.	1
5412ESSW6036086	0	9

This drawing is confidential and must not be reproduced or used without the consent of EXM

Ce dessin est confidentiel et ne doit pas être reproduit ou utilisé sans le consentement de EXM

NOTE	
ITEM	DESCRIPTION
1	NEMA 4X Enclosure
2	C/W Standard ground studs on box and cover
3	W/O Standard door stiffener
4	C/W Standard inner panel (Included)
5	C/W Standard inner panel mounting studs

No.	Revisions	Date	By/Par

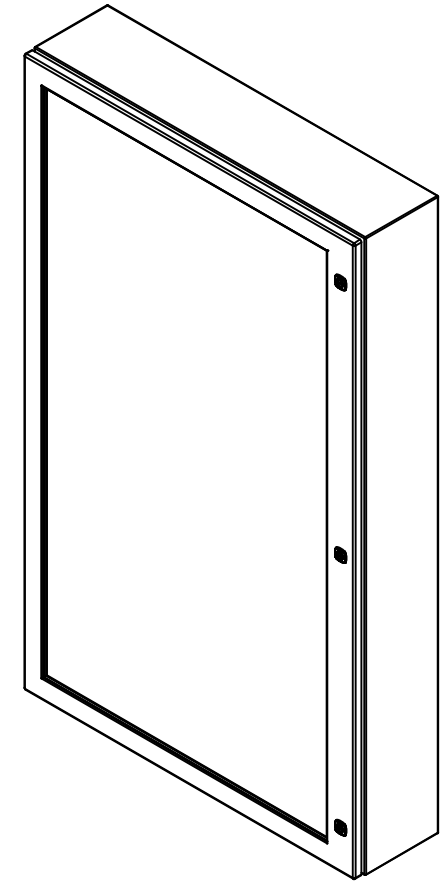

Isometric View



PACKING		
ITEM	QTY	DESCRIPTION
Cardboard sleeve	2	Top and Bottom
Cardboard strip	2	Between back of enclosure and inner panel
Plastic bag	1	To protect cover surface and inside gasket
Cardboard corner	4	To reinforced for the plastic strap tightening
Plastic strap - Black	2	To Squeeze the 2 cardboard sleeve together
Packaging label	3	White label with PN
Plastic strap- Green	2	To secure the enclosure to the wood pallet
Wood Pallet	1	2" deeper and 3" larger than enclosure size

1	881 SP6036G	0	881 SP - Inner Panel
4	STK-K-01320	0	5412 ES Inner Panel Accessory Kit
1	STK-K-01800	5	5412 ES Accessory Kit
1	5412ESSW6036086C	0	5412ESSW 60" x 36" Cover
1	5412ESSW6036086B	0	5412ESSW 60" x 36" x 8" Body
4	STK-Q-04051-08	1	M6 x 8mm Stainless Steel Hexagon Socket Head Machine Screw with Nyseal

Qty	Part Number	Rev	Description
Parts List			

	Tél: (450) 979-4373 Fax: (450) 979-4626 www.exmweb.com	Flatness Aplatissement Max 3.0mm Projection
	Customer Client Drawn By Dessiné Par	Date Date 21-Jun-23 BoxCad: BoxCad
Color Couleur Unpainted	Finish Fini Brushed	Description 5412ESSW 60" x 36" x 8" Assembly Detail Rev.
Part Number Numéro Pièce 5412ESSW6036086	Rev. 0	2 9

This drawing is confidential and must not be reproduced or used without the consent of EXM

Ce dessin est confidentiel et ne doit pas être reproduit ou utilisé sans le consentement de EXM

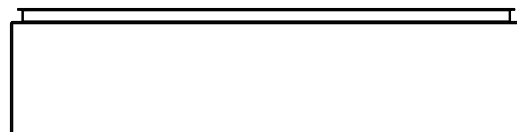

TOP

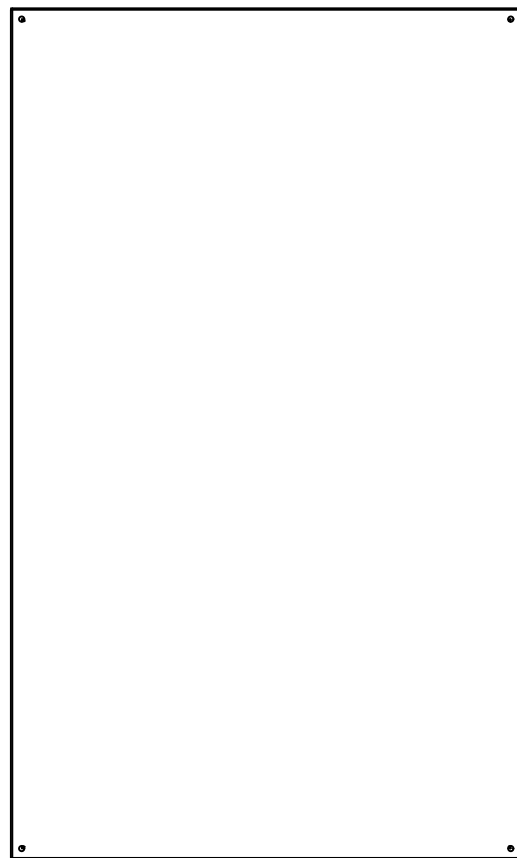

BACK

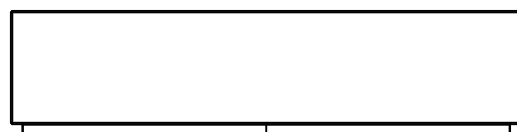

BOTTOM

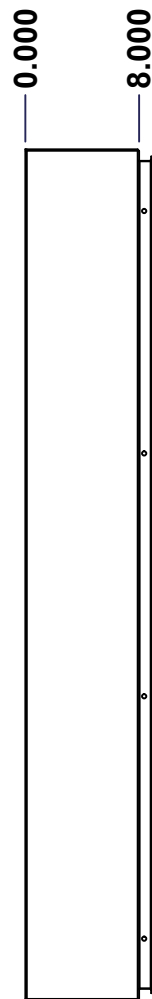

LEFT

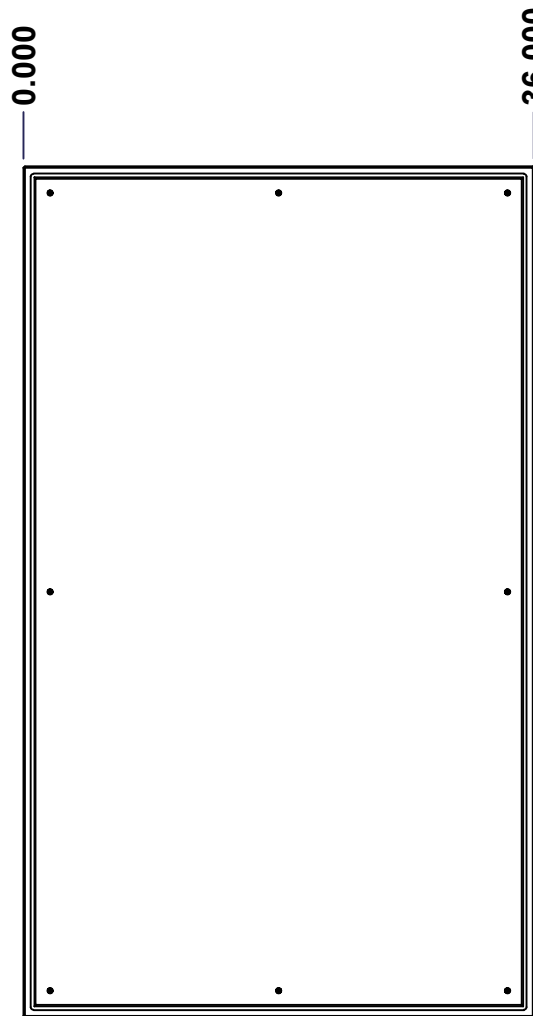

FRONT

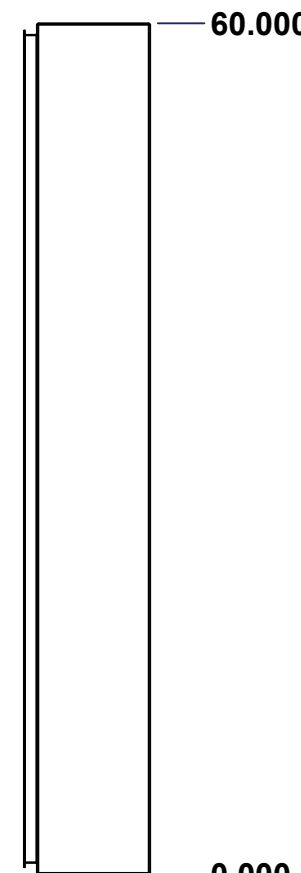

RIGHT

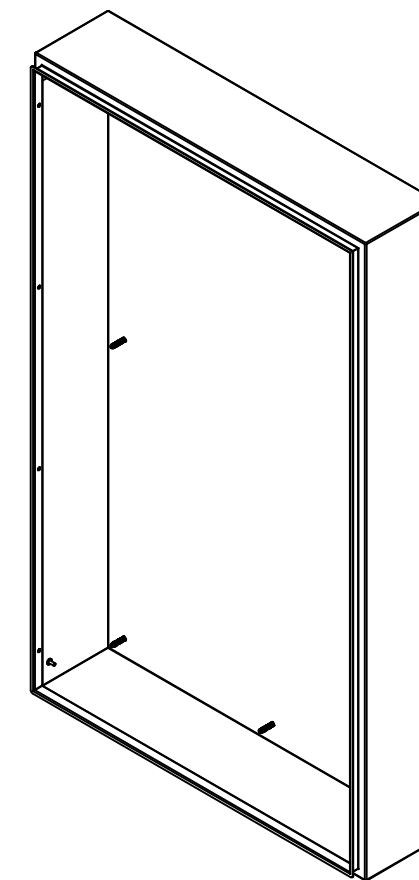

Isometric View

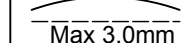

No.	Revisions	Date	By/Par

 Tél: (450) 979-4373 Fax: (450) 979-4626 www.exmweb.com		Flatness Aplatissement  Max 3.0mm
Customer Client		Date
Drawn By Dessiné Par	BoxCad: BoxCad	Date 21-Jun-23
Material Matière 14 Ga Stainless Steel 316 (1.7mm)		
Color Couleur	Unpainted	Finish Fini Brushed
Description 5412ESSW 60" x 36" x 8" Body		Detail Rev.
Part Number Numéro Pièce		Rev. 3 0

SEE BILL OF MATERIAL ON LAST PAGE

5412ESSW6036086B

9

This drawing is confidential and must not be reproduced or used without the consent of EXM

Ce dessin est confidentiel et ne doit pas être reproduit ou utilisé sans le consentement de EXM

STANDARD FEATURES ARE NOT LISTED IN THIS HOLE TABLE			
HOLE TABLE - LEFT VIEW (CUSTOM FEATURE ONLY)			
CUT-OUT	XDIM	YDIM	DESCRIPTION
1	6.500	2.000	GND STUD M6 x 16mm (Inside)
2	6.000	58.000	LABEL_EXM (Inside)

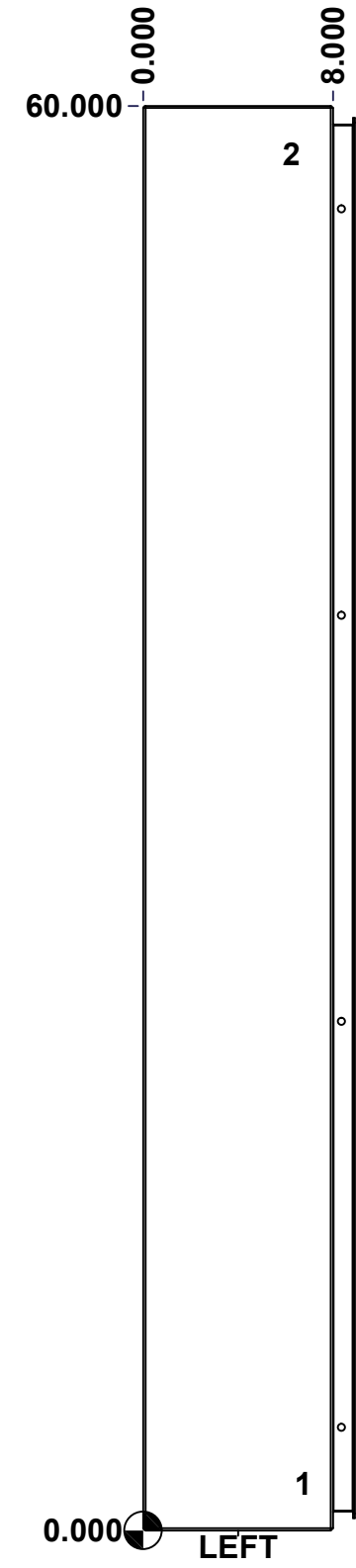

	Description	Status	
	5412ESSW 60" x 36" x 8" Body	(NULL)	
	Part Number Numéro Pièce	Rev.	
	5412ESSW6036086B	0	4/9

This drawing is confidential and must not be reproduced or used without the consent of EXM

Ce dessin est confidentiel et ne doit pas être reproduit ou utilisé sans le consentement de EXM

STANDARD FEATURES ARE NOT LISTED IN THIS HOLE TABLE

HOLE TABLE - BACK VIEW (CUSTOM FEATURE ONLY)

CUT-OUT	XDIM	YDIM	DESCRIPTION
1	1.875	1.875	IP STUD M8 x 35mm (Inside)
2	1.875	58.125	IP STUD M8 x 35mm (Inside)
3	34.125	58.125	IP STUD M8 x 35mm (Inside)
4	34.125	1.875	IP STUD M8 x 35mm (Inside)
5	1.875	30.000	IP STUD M8 x 35mm (Inside)
6	34.125	30.000	IP STUD M8 x 35mm (Inside)
7	18.000	1.875	IP STUD M8 x 35mm (Inside)
8	18.000	58.125	IP STUD M8 x 35mm (Inside)

9	35.250	0.750	RND Ø0.390
10	35.250	59.250	RND Ø0.390
11	0.750	59.250	RND Ø0.390
12	0.750	0.750	RND Ø0.390

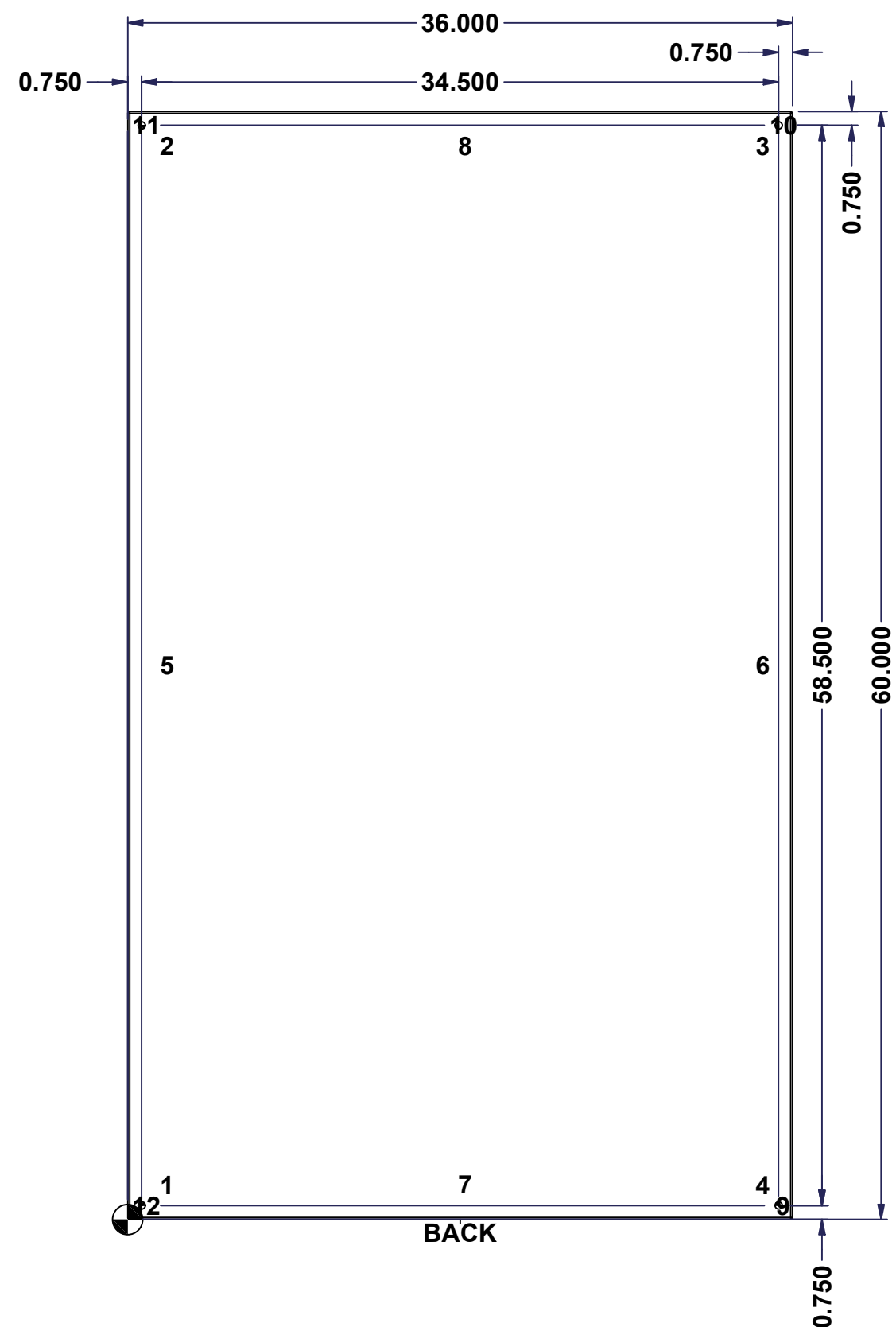

	Description		Status
	5412ESSW 60" x 36" x 8" Body		(NULL)
	Part Number Numéro Pièce		Rev.
	5412ESSW6036086B		0 / 5 / 9

This drawing is confidential and must not be reproduced or used without the consent of EXM

Ce dessin est confidentiel et ne doit pas être reproduit ou utilisé sans le consentement de EXM

No.	Revisions	Date	By/Par

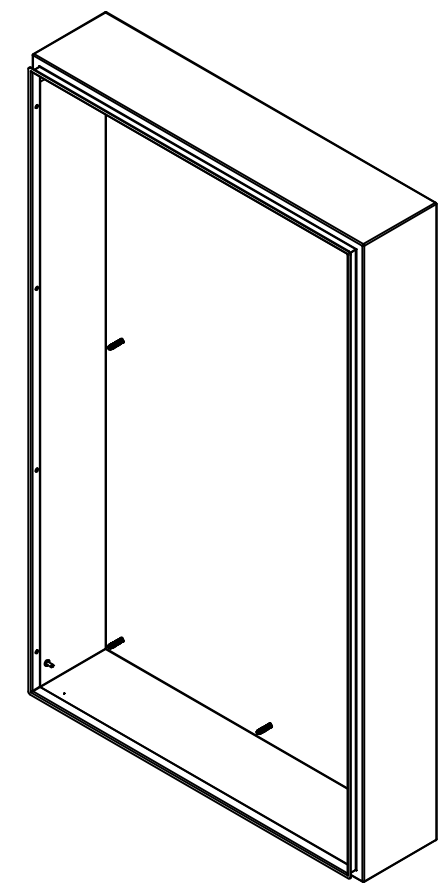

Isometric View

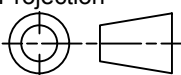

 Tél: (450) 979-4373 Fax: (450) 979-4626 www.exmweb.com		Flatness Aplatissement Max 3.0mm Projection 
Customer Client	Date	
Drawn By Dessiné Par	BoxCad: BoxCad	Date 21-Jun-23
Material Matière	14 Ga Stainless Steel 316 (1.7mm)	
Color Couleur	Unpainted	Finish Fini Brushed
Description	Detail Rev.	
5412ESSW 60" x 36" x 8" Body		
Part Number Numéro Pièce	Rev.	6
5412ESSW6036086B	0	9

Qty	Part Number	Rev	Description
1	STK-S-00100	0	3.5" x 2" Silver Milar Flexcon Sticker
1	STK-Q-16085	0	Ground Stud M6 x 16mm Stainless Steel
8	STK-Q-16020	1	Stud M8 x 35mm Stainless Steel
1	5412ESSW6036086B-P	0	5412ESSW 60" x 36" x 8" Body Part
Parts List			

This drawing is confidential and must not be reproduced or used without the consent of EXM

Ce dessin est confidentiel et ne doit pas être reproduit ou utilisé sans le consentement de EXM

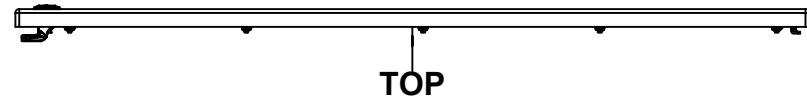

TOP

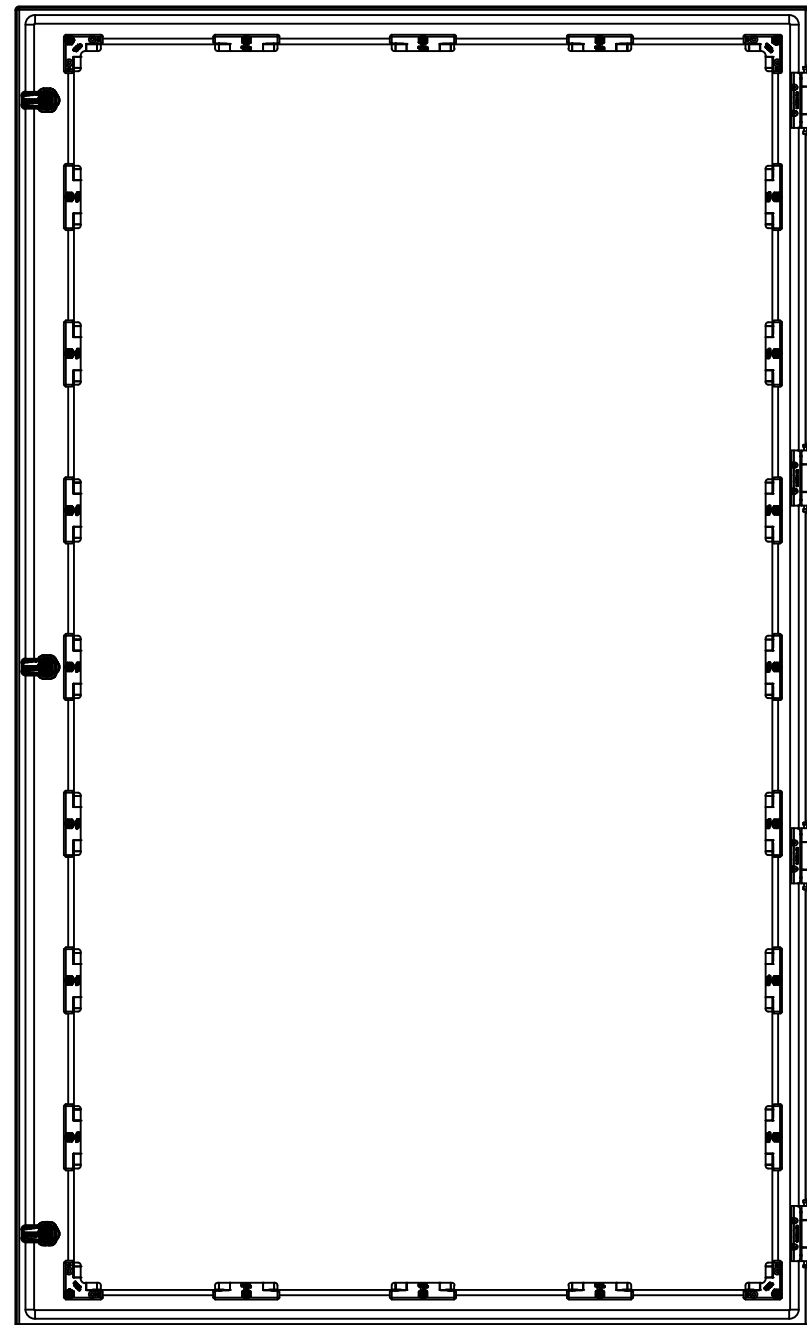

BACK



BOTTOM

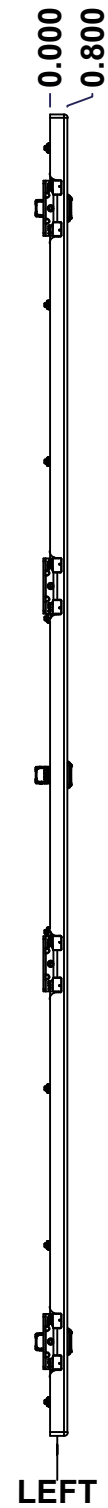

LEFT

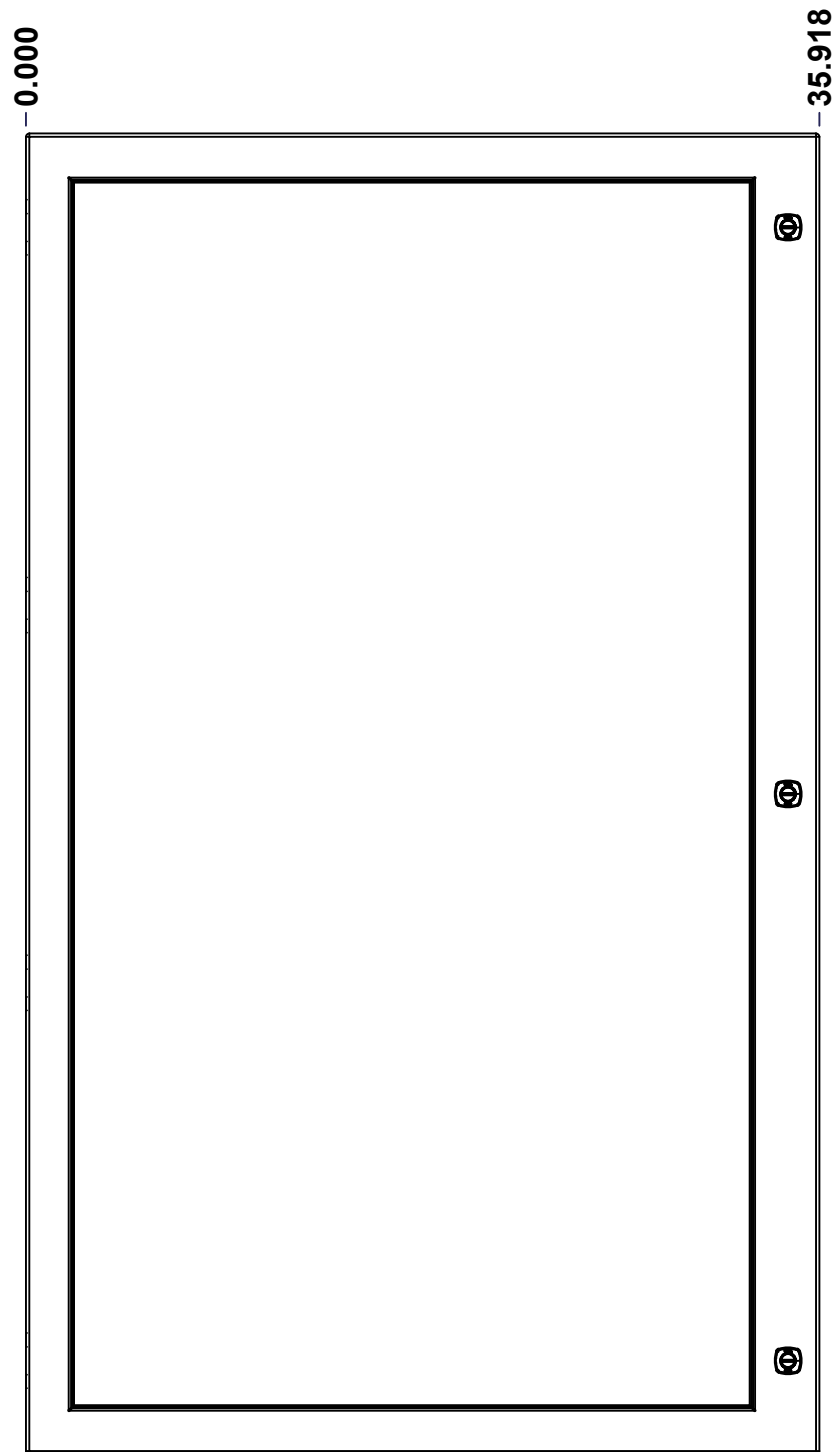

FRONT

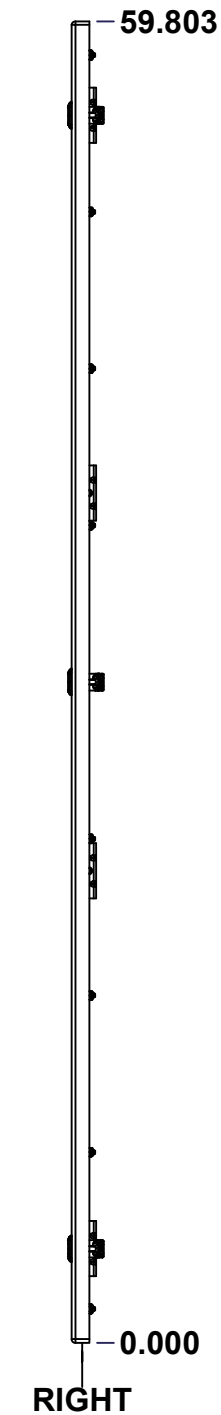

RIGHT

No.	Revisions	Date	By/Par

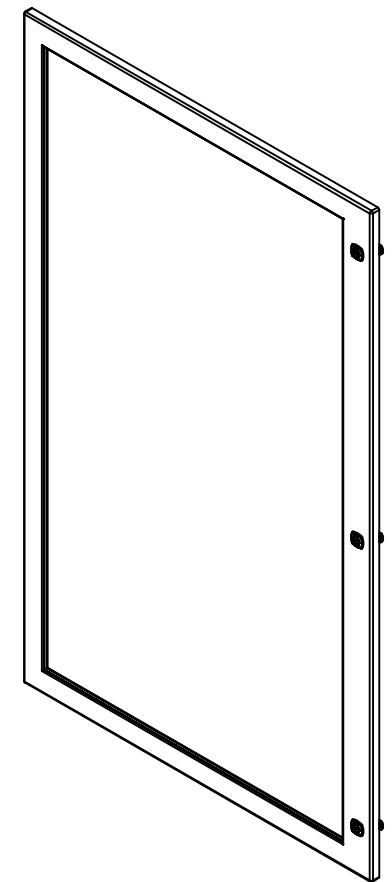

Isometric View



Tél: (450) 979-4373
 Fax: (450) 979-4626
www.exmweb.com

Flatness
Aplatissement

Max 3.0mm

Projection

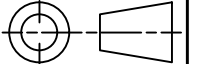

Customer Client	Date
Drawn By / Dessiné Par: BoxCad: BoxCad	Date: 21-Jun-23

Material / Matière: 14 Ga Stainless Steel 316 (1.7mm)

Color / Couleur: Unpainted	Finish / Fini: Brushed
----------------------------	------------------------

Description: 5412ESSW 60" x 36" Cover	Detail Rev.
---------------------------------------	-------------

Part Number / Numéro Pièce: 5412ESSW6036086C	Rev. 0	7	9
--	--------	---	---

SEE BILL OF MATERIAL ON LAST PAGE

This drawing is confidential and must not be reproduced or used without the consent of EXM

Ce dessin est confidentiel et ne doit pas être reproduit ou utilisé sans le consentement de EXM

STANDARD FEATURES ARE NOT LISTED IN THIS HOLE TABLE

HOLE TABLE - FRONT VIEW (CUSTOM FEATURE ONLY)

CUT-OUT	XDIM	YDIM	DESCRIPTION
1	1.469	8.621	STUD M6 x 18mm (Inside)
2	33.468	8.621	STUD M6 x 18mm (Inside)
3	1.469	15.714	STUD M6 x 18mm (Inside)
4	33.468	15.714	STUD M6 x 18mm (Inside)
5	1.469	22.808	STUD M6 x 18mm (Inside)
6	33.468	22.808	STUD M6 x 18mm (Inside)
7	1.469	29.902	STUD M6 x 18mm (Inside)
8	33.468	29.902	STUD M6 x 18mm (Inside)
9	1.469	36.995	STUD M6 x 18mm (Inside)
10	33.468	36.995	STUD M6 x 18mm (Inside)
11	1.469	44.089	STUD M6 x 18mm (Inside)
12	33.468	44.089	STUD M6 x 18mm (Inside)
13	1.469	51.182	STUD M6 x 18mm (Inside)
14	33.468	51.182	STUD M6 x 18mm (Inside)
15	1.469	58.276	STUD M6 x 18mm (Inside)
16	1.469	1.527	STUD M6 x 18mm (Inside)
17	9.469	58.276	STUD M6 x 18mm (Inside)
18	9.469	1.527	STUD M6 x 18mm (Inside)
19	17.469	58.276	STUD M6 x 18mm (Inside)
20	17.469	1.527	STUD M6 x 18mm (Inside)
21	25.468	58.276	STUD M6 x 18mm (Inside)
22	25.468	1.527	STUD M6 x 18mm (Inside)
23	33.468	58.276	STUD M6 x 18mm (Inside)
24	33.468	1.527	STUD M6 x 18mm (Inside)

25	34.494	55.553	880 SCQ4-SLSS6
26	34.494	29.902	880 SCQ4-SLSS6
27	34.494	4.250	880 SCQ4-SLSS6

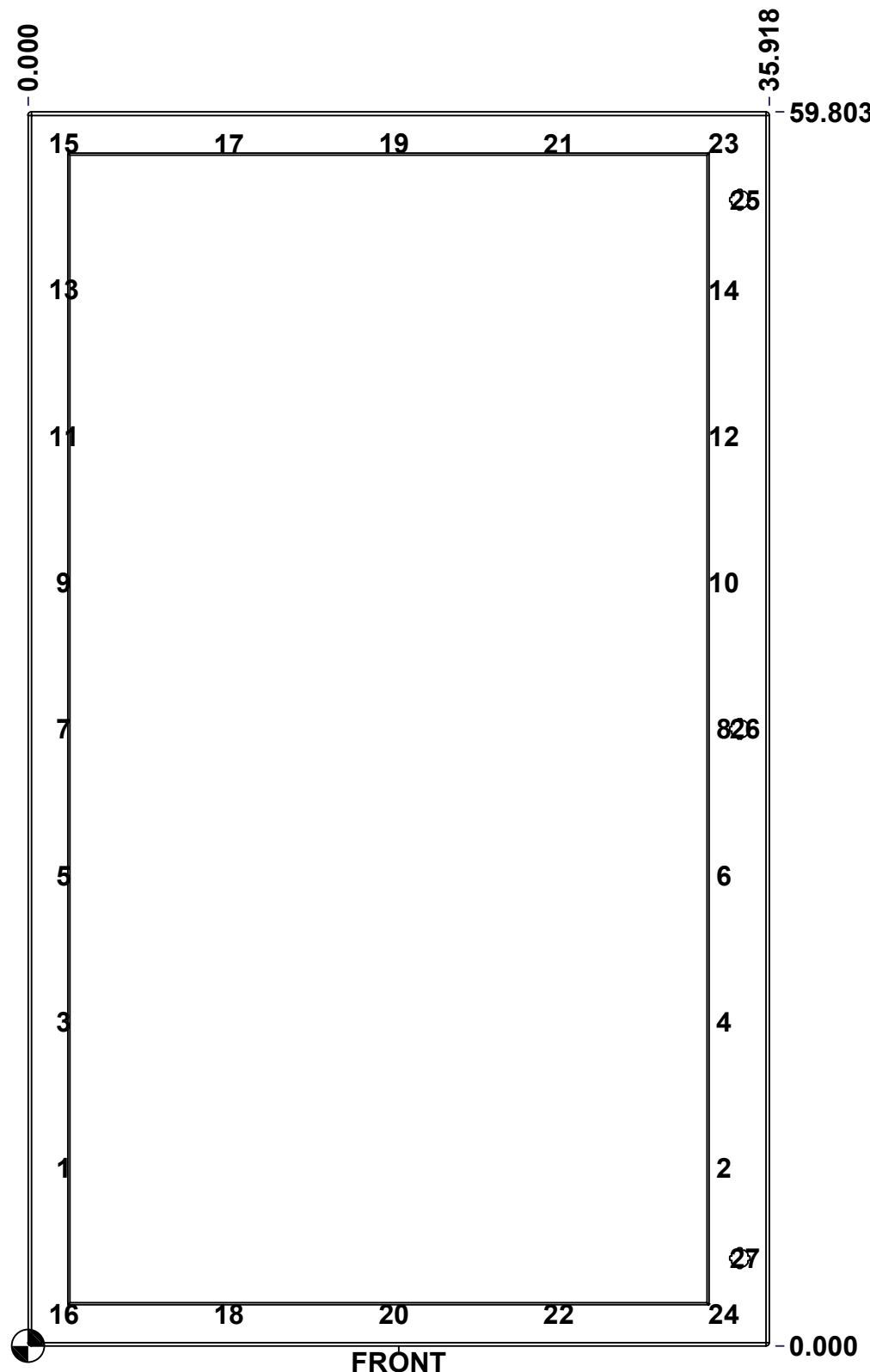

	Description		Status
	5412ESSW 60" x 36" Cover		(NULL)
Part Number		Rev.	
5412ESSW6036086C		0	8 9

This drawing is confidential and must not be reproduced or used without the consent of EXM

Ce dessin est confidentiel et ne doit pas être reproduit ou utilisé sans le consentement de EXM

No.	Revisions	Date	By/Par

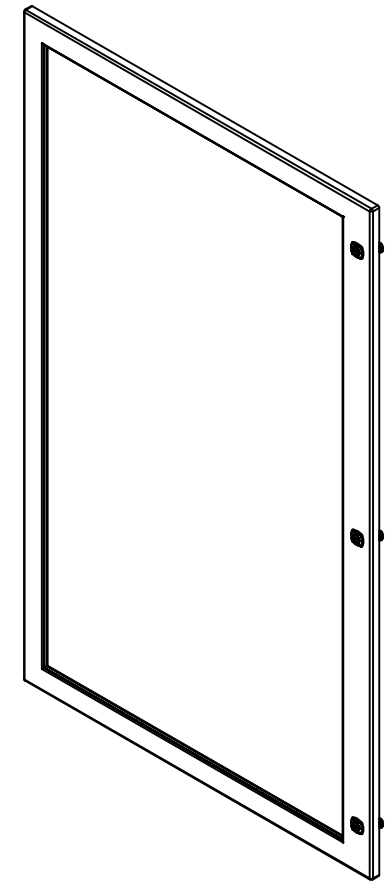

Isometric View



EXM
www.exmweb.com

Tél: (450) 979-4373
Fax: (450) 979-4626

Flatness
Aplatissement
Max 3.0mm

Projection

20	STK-Q-60701	2.1	880 WK - Lexan 1/4" Fixing Bracket
1	STK-A-60703	0	5412 ESW Lexan Bracket Kit
24	STK-Q-16053	1	Stud M6 x 23mm Stainless steel
1	STK-G-02710	0	880 HWKG - Windows Kit Gasket
1	5412ESSW6036086LXG	0	5412ESSW 60" x 36" Lexan Gasket Part
1	5412ESSW6036086LX	0	5412ESSW 56.375" x 32.125" Lexan Part
1	5412ESSW6036086G	0	5412ESSW 60" x 36" Cover Gasket Part
1	5412ESSW6036086C-P	0	5412ESSW 60" x 36" Cover Part
3	880 SCQ4-SLSS6	7	5412 ESS 1/4 Turn Lock
4	STK-A-33016	0	5412 ESS Bended Hinge (Body Part)
QTY	Part Number	Rev	Description
Parts List			

Customer Client

Drawn By / Dessiné Par: BoxCad: BoxCad

Material / Matière: 14 Ga Stainless Steel 316 (1.7mm)

Color / Couleur: Unpainted

Finish / Fini: Brushed

Description: 5412ESSW 60" x 36" Cover

Part Number / Numéro Pièce: **5412ESSW6036086C**

Date: 21-Jun-23

Detail Rev.:

Rev.	9
	0
	9

This drawing is confidential and must not be reproduced or used without the consent of EXM

Ce dessin est confidentiel et ne doit pas être reproduit ou utilisé sans le consentement de EXM

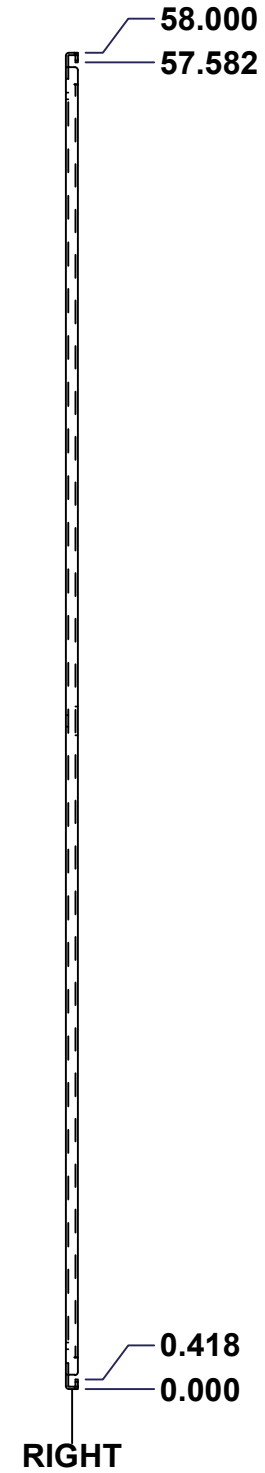
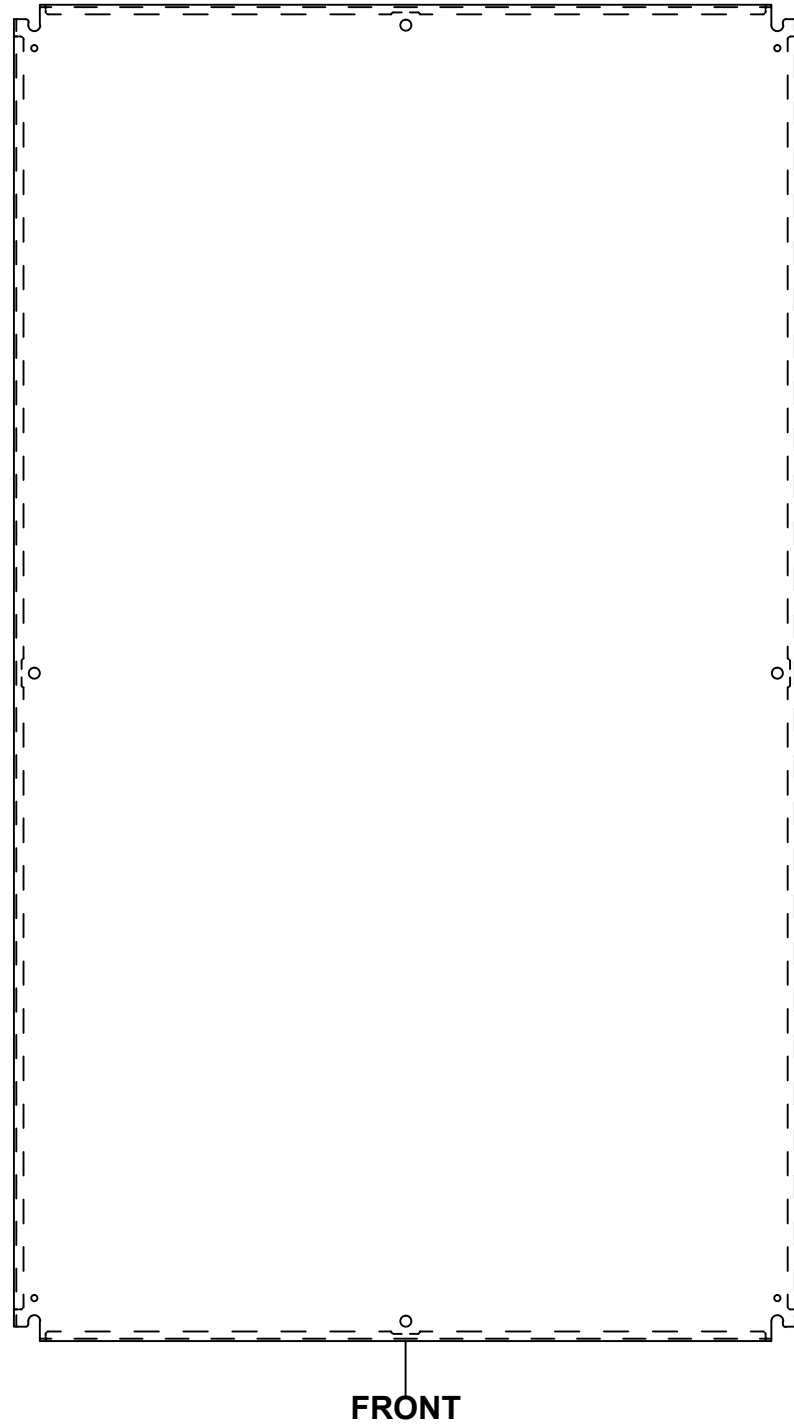
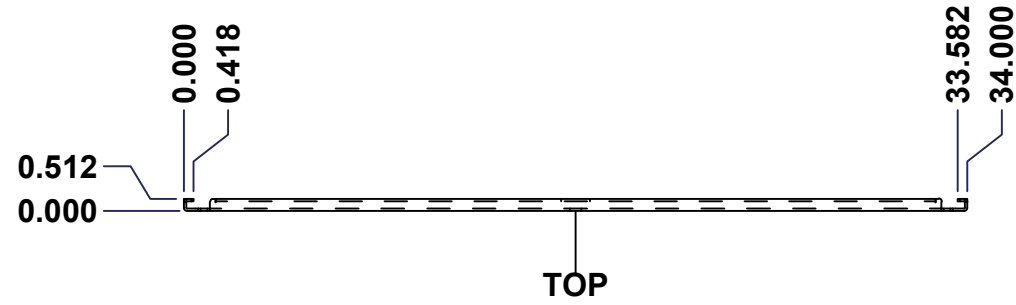

No.	Revisions	Date	By/Par

Isometric View

Tél: (450) 979-4373 Fax: (450) 979-4626 www.exmweb.com		Flatness Aplatissement Max 3.0mm Projection
Customer Client	Date	
Drawn By Dessiné Par: BoxCad	Date: 23-Jan-07	
Material Matière	See Part List	
Color Couleur	See Part List	Finish Fini: See Part List
Description 881 SP - Inner Panel		Detail Rev.
Part Number Numéro Pièce: 881 SP6036G	Rev. 0	1 2

Qty	Part Number	Rev	Description	Material	Color	Finish
1	881 SP6036G-P	0	881 SP - Inner Panel Part	12 Ga Galvanized	Unpainted	Galvanized

Parts List

This drawing is confidential and must not be reproduced or used without the consent of EXM

Ce dessin est confidentiel et ne doit pas être reproduit ou utilisé sans le consentement de EXM

Table 1			FRONT VIEW
CUT-OUT	XDIM	YDIM	DESCRIPTION
1	17.000	0.875	MTG STUD HOLE (RND Ø0.500)
2	0.875	29.000	MTG STUD HOLE (RND Ø0.500)
3	33.125	29.000	MTG STUD HOLE (RND Ø0.500)
4	17.000	57.125	MTG STUD HOLE (RND Ø0.500)
5	0.875	1.875	GROUND HOLE (RND Ø0.290)
6	33.125	1.875	GROUND HOLE (RND Ø0.290)
7	0.875	56.125	GROUND HOLE (RND Ø0.290)
8	33.125	56.125	GROUND HOLE (RND Ø0.290)

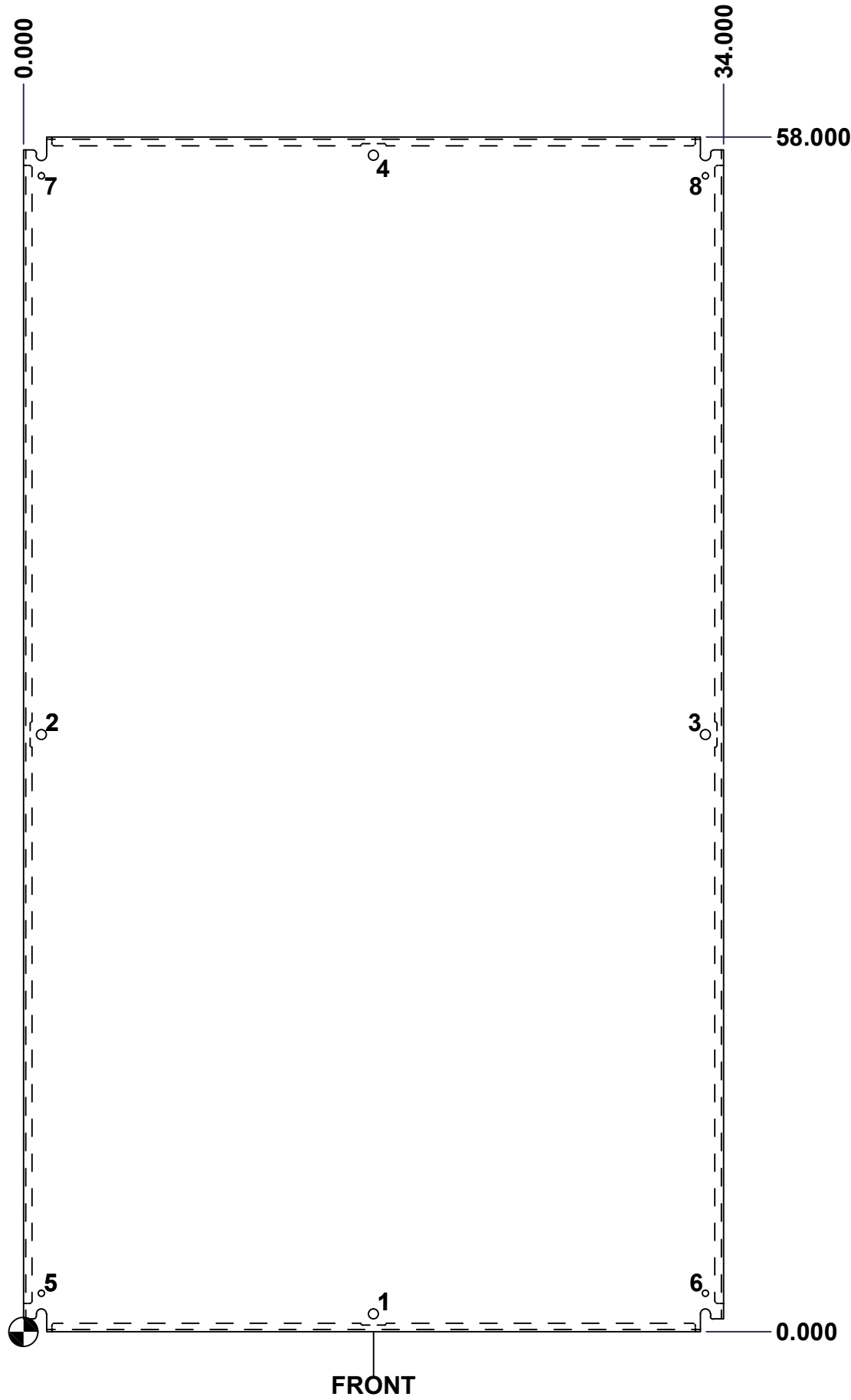

All knockouts are actual size / Les disques défonçables sont grandeur réel

No.	Revisions	Date	By/Par

Isometric View

		Tél: (450) 979-4373 Fax: (450) 979-4626 www.exmweb.com		Flatness Aplatissement Max 3.0mm	
Customer Client		Date		Projection 	
Drawn By Dessiné Par		BoxCad		Date 23-Jan-07	
Material Matière		See Part List			
Color Couleur		See Part List		Finish Fini	
Description 881 SP - Inner Panel				Detail Rev.	
Part Number Numéro Pièce 881 SP6036G				Rev. 2 0	