

This drawing is confidential and must not be reproduced or used without the consent of EXM

Ce dessin est confidentiel et ne doit pas être reproduit ou utilisé sans le consentement de EXM

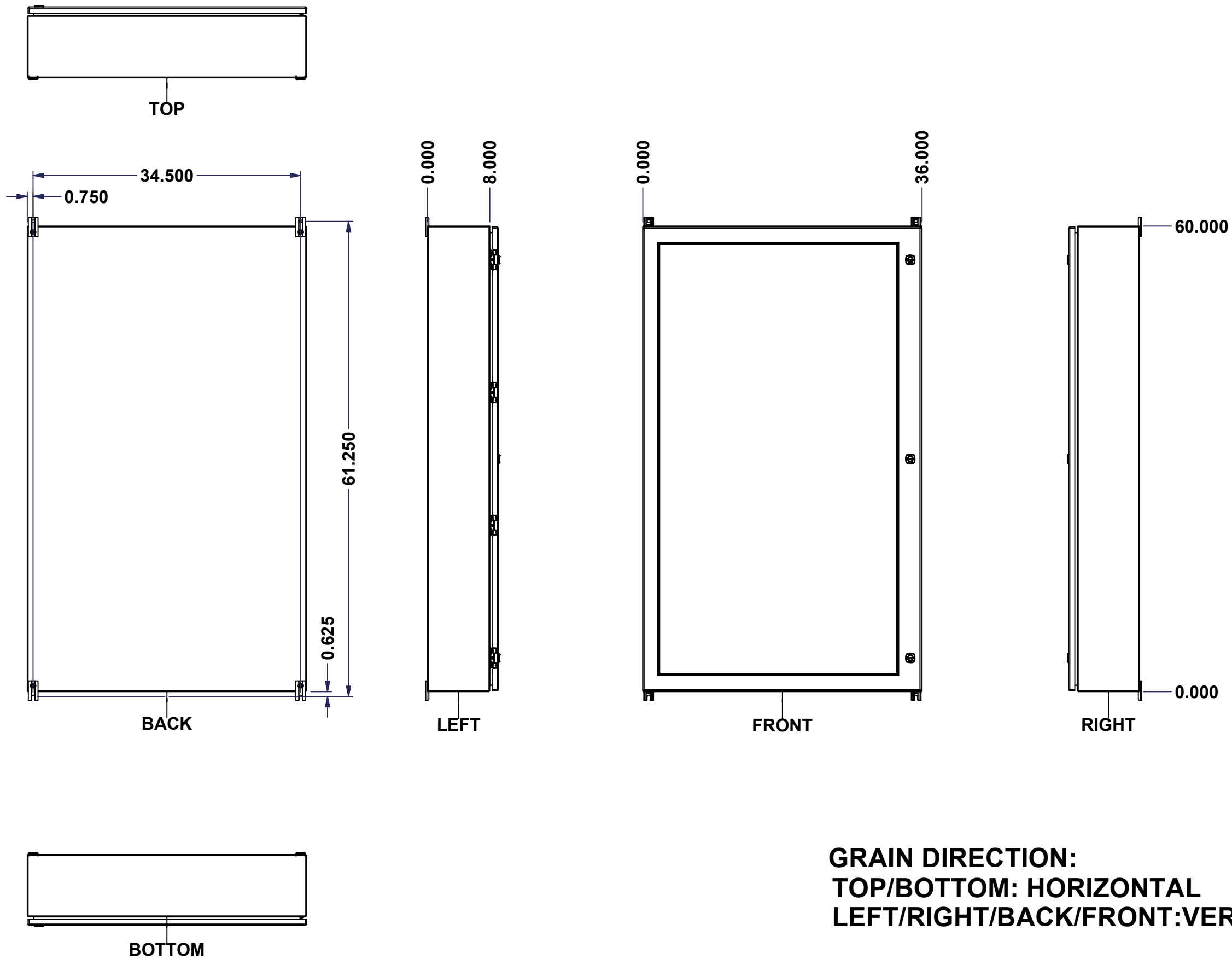

GRAIN DIRECTION:
TOP/BOTTOM: HORIZONTAL
LEFT/RIGHT/BACK/FRONT: VERTICAL

| No. | Revisions | Date | By/Par |
|-----|-----------|------|--------|
| | | | |
| | | | |
| | | | |
| | | | |

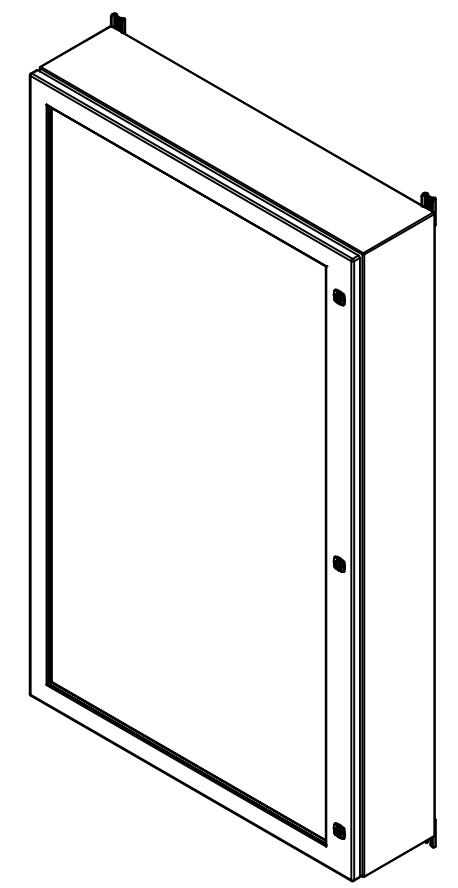

Isometric View



| | | |
|--|-----------------------------------|--|
| Tél: (450) 979-4373 Fax: (450) 979-4626 www.exmweb.com | | Flatness Aplatissement Max 3.0mm Projection |
| Customer Client | Date | |
| Drawn By Dessiné Par | BoxCad: BoxCad | Date 06-Jun-23 |
| Material Matière | 14 Ga Stainless Steel 316 (1.7mm) | |
| Color Couleur | Unpainted | Finish Fini Brushed |
| Description | Detail Rev. | |
| 5412ESSW 60" x 36" x 8" Assembly | | |
| Part Number Numéro Pièce | Rev. 0 | 1 / 15 |
| 5412ESSW6036086TH | | |

SEE BILL OF MATERIAL ON LAST PAGE

This drawing is confidential and must not be reproduced or used without the consent of EXM

Ce dessin est confidentiel et ne doit pas être reproduit ou utilisé sans le consentement de EXM

| NOTE | |
|------|---|
| ITEM | DESCRIPTION |
| 1 | NEMA 4X Enclosure |
| 2 | C/W Standard ground studs on box and cover |
| 3 | W/O Standard door stiffener |
| 4 | C/W Standard inner panel (Included) |
| 5 | C/W Standard inner panel mounting studs |
| 6 | C/W 885 ESMF4_OPEN Sold separately (Installed) |
| 7 | C/W 885 ESMF4_CLOSE Sold separately (Installed) |
| 8 | C/W R5 Insulation (Installed by EXM) |

| No. | Revisions | Date | By/Par |
|-----|-----------|------|--------|
| | | | |
| | | | |
| | | | |
| | | | |
| | | | |

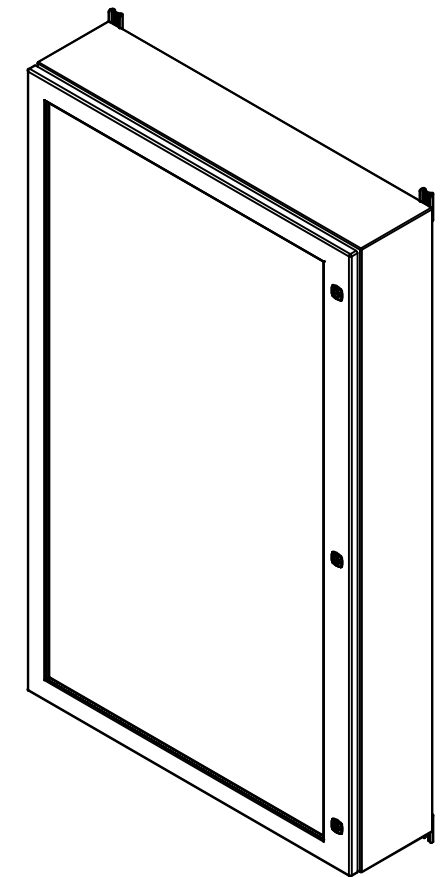

Isometric View



| PACKING | | |
|-----------------------|-----|--|
| ITEM | QTY | DESCRIPTION |
| Cardboard sleeve | 2 | Top and Bottom |
| Cardboard strip | 2 | Between back of enclosure and inner panel |
| Plastic bag | 1 | To protect cover surface and inside gasket |
| Cardboard corner | 4 | To reinforced for the plastic strap tightening |
| Plastic strap - Black | 2 | To Squeeze the 2 cardboard sleeve together |
| Packaging label | 3 | White label with PN |
| Plastic strap- Green | 2 | To secure the enclosure to the wood pallet |
| Wood Pallet | 1 | 2" deeper and 3" larger than enclosure size |

| | | | |
|------------|--------------------|-----|--|
| 8 | STK-Q-00600 | 2 | M12 to M8 Adaptor |
| 1 | 881 SP6036G | 0 | 881 SP - Inner Panel |
| 1 | STK-K-01800 | 5 | 5412 ES Accessory Kit |
| 1 | 5412ESSW6036086THC | 0 | 5412ESSW 60" x 36" Cover |
| 1 | 5412ESSW6036086THB | 0 | 5412ESSW 60" x 36" x 8" Body |
| 4 | STK-Q-04051-08 | 1 | M6 x 8mm Stainless Steel Hexagon Socket Head Machine Screw with Nyseal |
| Qty | Part Number | Rev | Description |
| Parts List | | | |

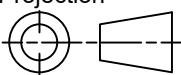
| | | |
|--|-----------------------------------|---|
|  Tél: (450) 979-4373 Fax: (450) 979-4626 www.exmweb.com | Flatness Aplatissement | Max 3.0mm |
| | Projection |  |
| Customer Client | Date | |
| Drawn By Dessiné Par | BoxCad: BoxCad | Date 06-Jun-23 |
| Material Matière | 14 Ga Stainless Steel 316 (1.7mm) | |
| Color Couleur | Unpainted | Finish Fini Brushed |
| Description | Detail Rev. | |
| 5412ESSW 60" x 36" x 8" Assembly | | |
| Part Number Numéro Pièce | Rev. | 2 |
| 5412ESSW6036086TH | 0 | 15 |

This drawing is confidential and must not be reproduced or used without the consent of EXM

Ce dessin est confidentiel et ne doit pas être reproduit ou utilisé sans le consentement de EXM

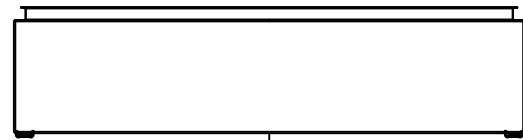

TOP

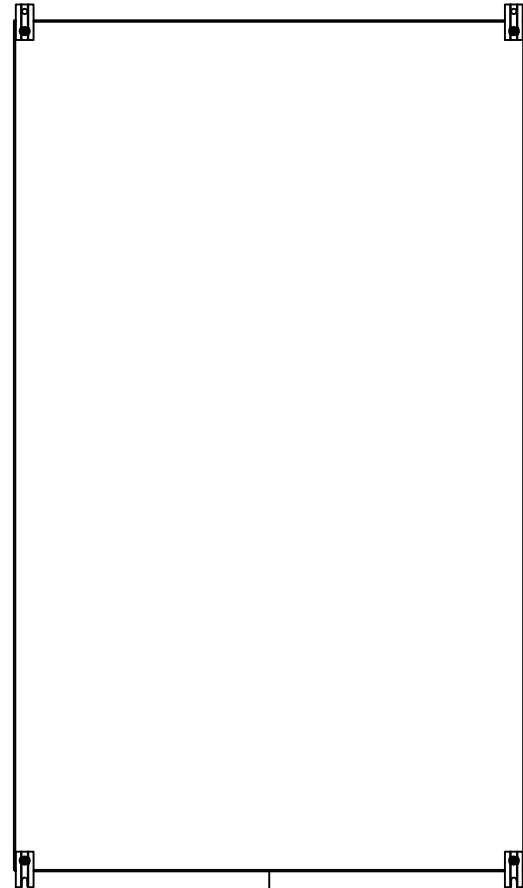

BACK

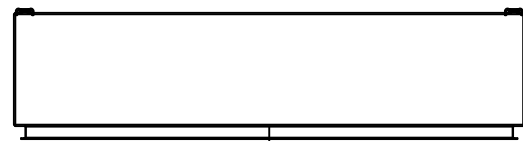

BOTTOM

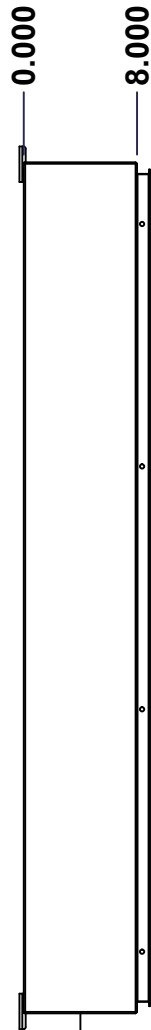

LEFT

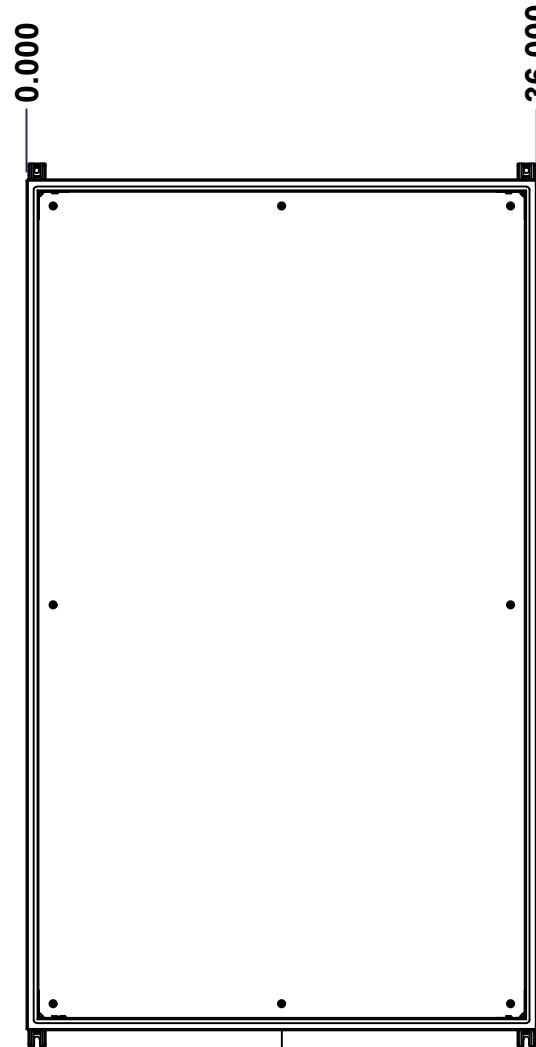

FRONT

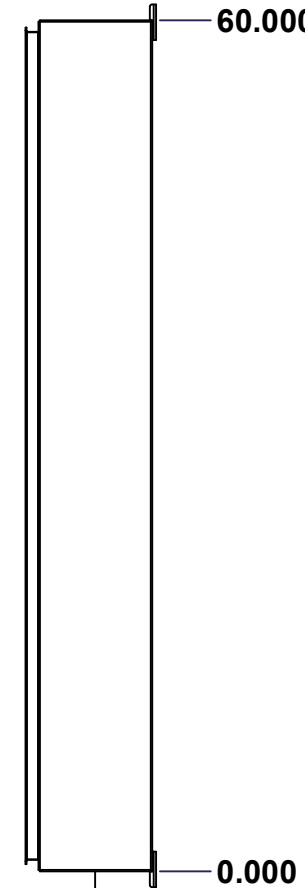

RIGHT

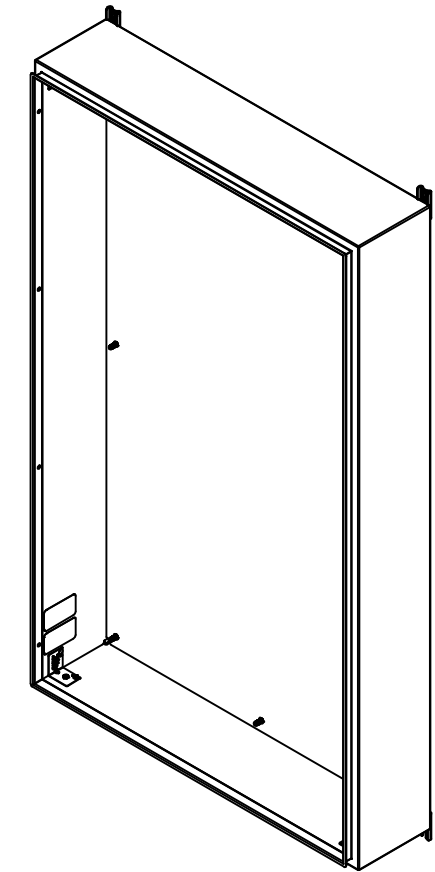

Isometric View

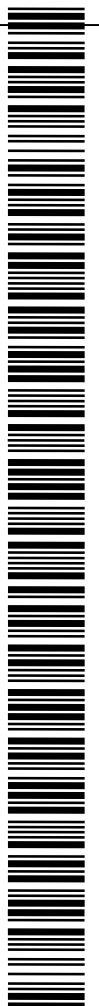

| No. | Revisions | Date | By/Par |
|-----|-----------|------|--------|
| | | | |
| | | | |
| | | | |
| | | | |

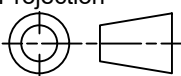
| | | |
|--|-----------------------------------|---|
|  Tél: (450) 979-4373 Fax: (450) 979-4626 www.exmweb.com | | Flatness Aplatissement Max 3.0mm Projection  |
| Customer Client | Date | |
| Drawn By Dessiné Par | BoxCad: BoxCad | Date 06-Jun-23 |
| Material Matière | 14 Ga Stainless Steel 316 (1.7mm) | |
| Color Couleur | Unpainted | Finish Fini Brushed |
| Description | Detail Rev. | |
| 5412ESSW 60" x 36" x 8" Body | | |
| Part Number Numéro Pièce | Rev. 0 | 3 15 |

SEE BILL OF MATERIAL ON LAST PAGE

5412ESSW6036086THB

This drawing is confidential and must not be reproduced or used without the consent of EXM

Ce dessin est confidentiel et ne doit pas être reproduit ou utilisé sans le consentement de EXM

| STANDARD FEATURES ARE NOT LISTED IN THIS HOLE TABLE | | | |
|---|--------|-------|--------------------------------|
| HOLE TABLE - TOP VIEW (CUSTOM FEATURE ONLY) | | | |
| CUT-OUT | XDIM | YDIM | DESCRIPTION |
| 1 | 2.000 | 6.500 | INSUL. STUD M6 x 18mm (Inside) |
| 2 | 34.000 | 6.500 | INSUL. STUD M6 x 18mm (Inside) |

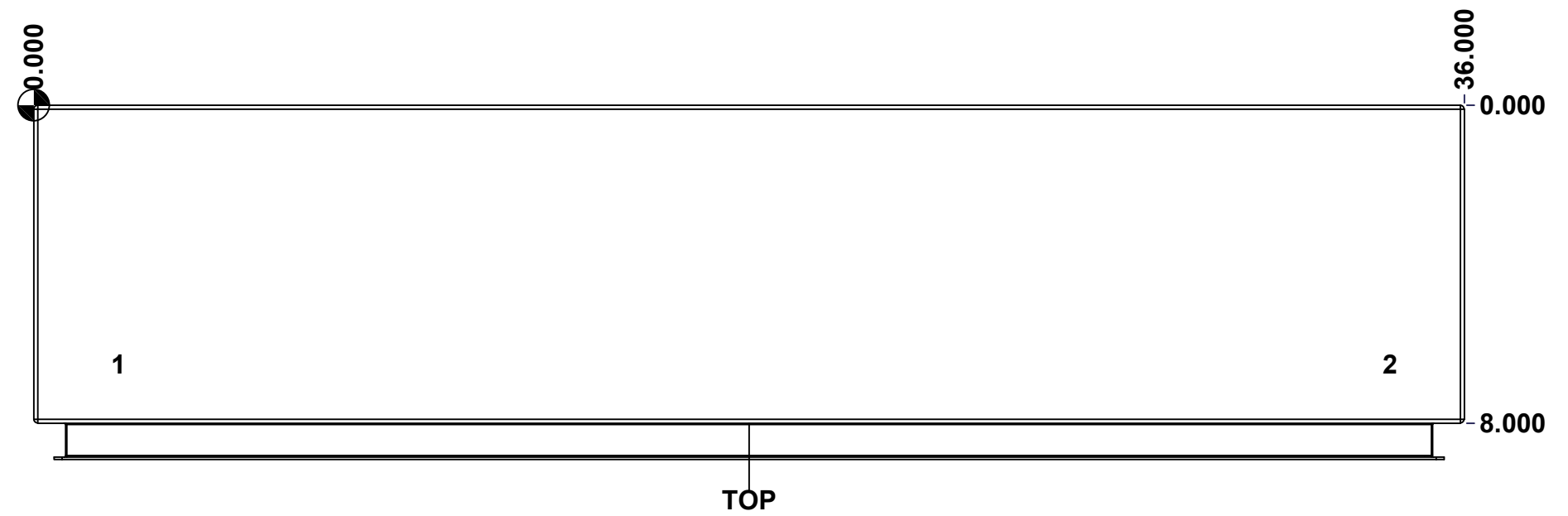

| | | |
|--|------------------------------|----------|
| | Description | Status |
| | 5412ESSW 60" x 36" x 8" Body | (NULL) |
| | Part Number Numéro Pièce | Rev. |
| | 5412ESSW6036086THB | 0 |
| | | 4 |
| | | 15 |

This drawing is confidential and must not be reproduced or used without the consent of EXM

Ce dessin est confidentiel et ne doit pas être reproduit ou utilisé sans le consentement de EXM

| STANDARD FEATURES ARE NOT LISTED IN THIS HOLE TABLE | | | |
|--|--------|-------|--------------------------------|
| HOLE TABLE - BOTTOM VIEW (CUSTOM FEATURE ONLY) | | | |
| CUT-OUT | XDIM | YDIM | DESCRIPTION |
| 1 | 2.000 | 6.500 | INSUL. STUD M6 x 18mm (Inside) |
| 2 | 34.000 | 6.500 | INSUL. STUD M6 x 18mm (Inside) |

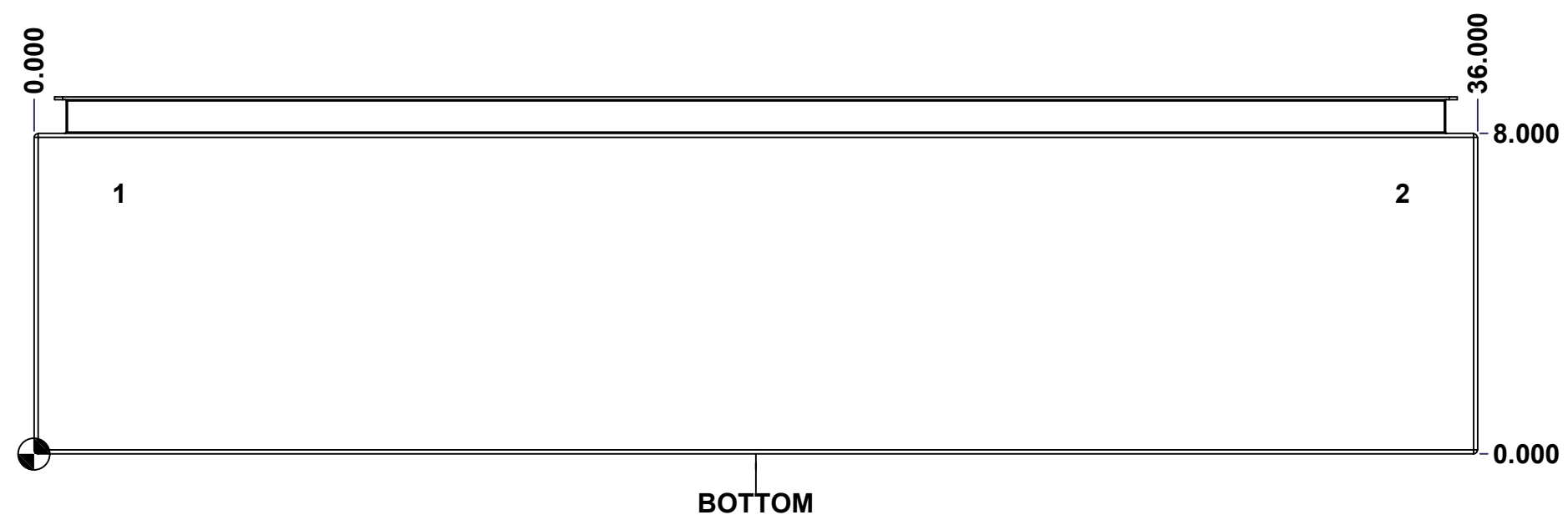

| | | |
|--|------------------------------|----------|
| | Description | Status |
| | 5412ESSW 60" x 36" x 8" Body | (NULL) |
| | Part Number Numéro Pièce | Rev. |
| | 5412ESSW6036086THB | 0 |
| | | 5 |
| | | 15 |

This drawing is confidential and must not be reproduced or used without the consent of EXM

Ce dessin est confidentiel et ne doit pas être reproduit ou utilisé sans le consentement de EXM

STANDARD FEATURES ARE NOT LISTED IN THIS HOLE TABLE

HOLE TABLE - BACK VIEW (CUSTOM FEATURE ONLY)

| CUT-OUT | XDIM | YDIM | DESCRIPTION |
|---------|--------|--------|----------------------------|
| 1 | 1.875 | 1.875 | IP STUD M8 x 35mm (Inside) |
| 2 | 1.875 | 58.125 | IP STUD M8 x 35mm (Inside) |
| 3 | 34.125 | 58.125 | IP STUD M8 x 35mm (Inside) |
| 4 | 34.125 | 1.875 | IP STUD M8 x 35mm (Inside) |
| 5 | 1.875 | 30.000 | IP STUD M8 x 35mm (Inside) |
| 6 | 34.125 | 30.000 | IP STUD M8 x 35mm (Inside) |
| 7 | 18.000 | 1.875 | IP STUD M8 x 35mm (Inside) |
| 8 | 18.000 | 58.125 | IP STUD M8 x 35mm (Inside) |
| ----- | | | |
| 9 | 35.250 | 0.000 | FOOT 885 ESMF4_OPEN |
| 10 | 0.750 | 0.000 | FOOT 885 ESMF4_OPEN |
| 11 | 35.250 | 60.000 | FOOT 885 ESMF4_CLOSE |
| 12 | 0.750 | 60.000 | FOOT 885 ESMF4_CLOSE |

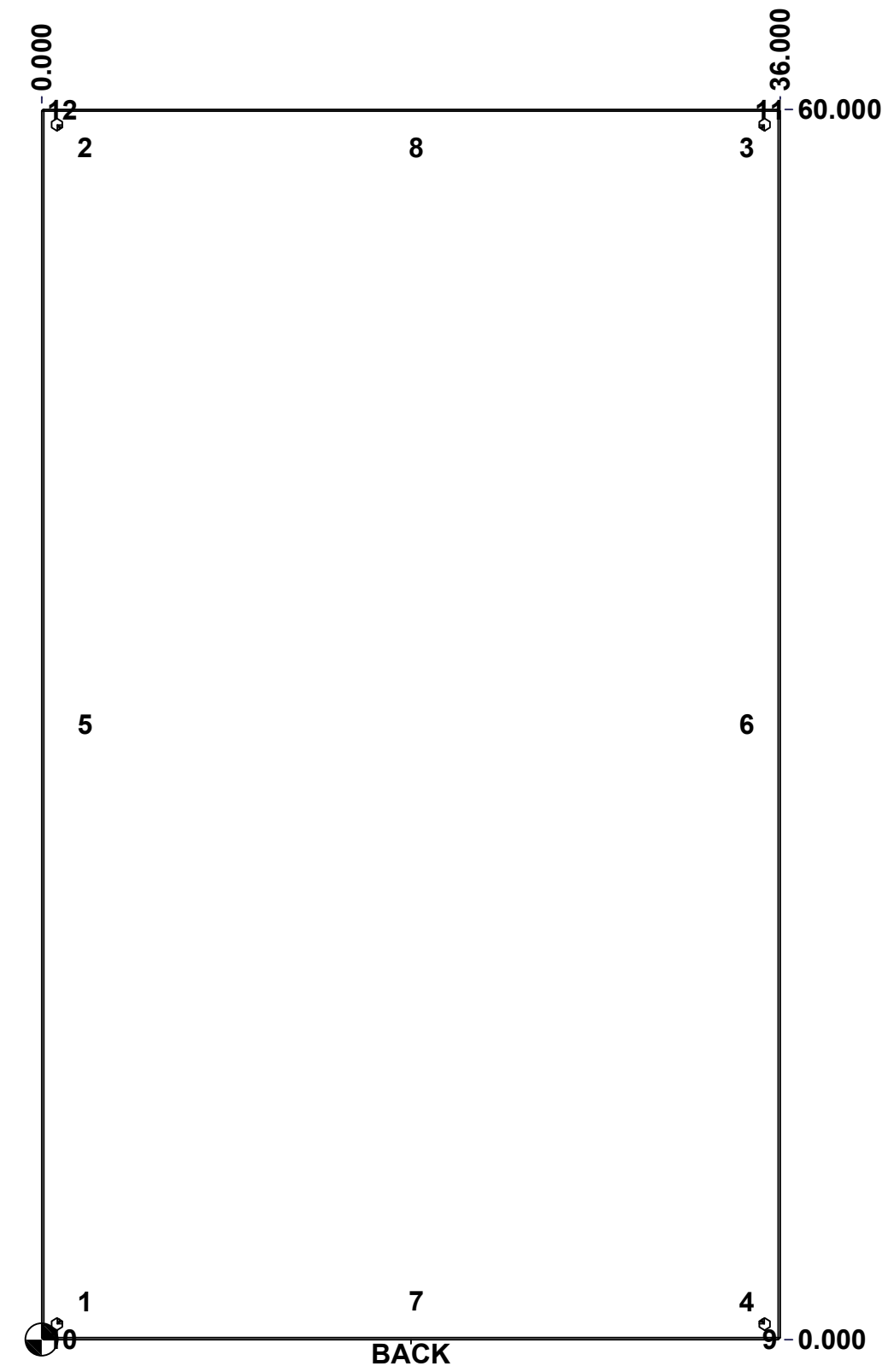

| | | |
|--|------------------------------|--------|
| | Description | Status |
| | 5412ESSW 60" x 36" x 8" Body | (NULL) |
| | Part Number Numéro Pièce | Rev. |
| | 5412ESSW6036086THB | 6 0 |
| | | 15 |

This drawing is confidential and must not be reproduced or used without the consent of EXM

Ce dessin est confidentiel et ne doit pas être reproduit ou utilisé sans le consentement de EXM

| No. | Revisions | Date | By/Par |
|-----|-----------|------|--------|
| | | | |
| | | | |
| | | | |
| | | | |
| | | | |

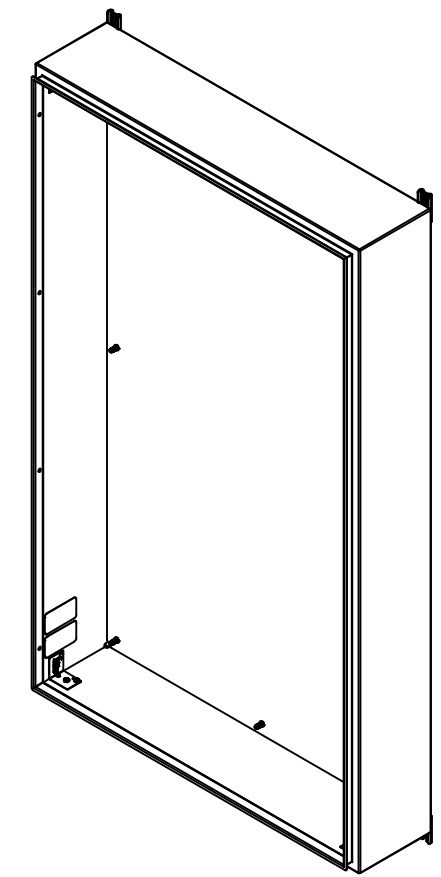

Isometric View



| | | | |
|---|------------------------|---|---|
| 2 | 885ESMF4-FEET | 0 | 885 ESMF4 Stainless Steel Mounting Foot |
| 4 | RIVET_NUT_SS_M10_FH_CE | 0 | Stainless Steel Rivet Nut M10 (Low Profile Close End) |
| 4 | STK-Q-06670 | 2 | M10 x 16mm Stainless Steel Machine Screw |
| 2 | 885ESMF4-FEET-A | 0 | 885 ESMF4 Stainless Steel Mounting Foot (Opened Slot) |
| 2 | STK-S-00100 | 0 | 3.5" x 2" Silver Milar Flexcon Sticker |
| 1 | STK-K-70554 | 3 | 5412 ESTH Accessory Kit |
| 1 | 5412ESSW6036086THI-RS | 0 | 5412ESSW 60" x 36" Right Insulation |
| 1 | 5412ESSW6036086THI-LS | 0 | 5412ESSW 60" x 36" Left Insulation |
| 1 | 5412ESSW6036086THI-BT | 0 | 5412ESSW 60" x 36" Top and Bottom Insulation |
| 1 | 5412ESSW6036086THI-TP | 0 | 5412ESSW 60" x 36" Top and Bottom Insulation |
| 1 | 5412ESSW6036086THI-B | 0 | 5412ESSW 60" x 36" Back Insulation |
| 4 | STK-Q-16070 | 1 | Stud M6 x 18mm Stainless steel |
| 8 | STK-Q-16020 | 1 | Stud M8 x 35mm Stainless Steel |
| 1 | 5412ESSW6036086THB-P | 0 | 5412ESSW 60" x 36" x 8" Body Part |

| Qty | Part Number | Rev | Description |
|------------|-------------|-----|-------------|
| Parts List | | | |

| | | |
|--|------------------------|--|
| Tél: (450) 979-4373 Fax: (450) 979-4626 www.exmweb.com | | Flatness Aplatissement Max 3.0mm |
| Customer Client | | Projection |
| Drawn By Dessiné Par BoxCad: BoxCad | | Date 06-Jun-23 |
| Material Matière 14 Ga Stainless Steel 316 (1.7mm) | | |
| Color Couleur Unpainted | Finish Fini Brushed | |
| Description 5412ESSW 60" x 36" x 8" Body | | Detail Rev. |
| Part Number Numéro Pièce 5412ESSW6036086THB | | Rev. 0 / 7 |

This drawing is confidential and must not be reproduced or used without the consent of EXM

Ce dessin est confidentiel et ne doit pas être reproduit ou utilisé sans le consentement de EXM

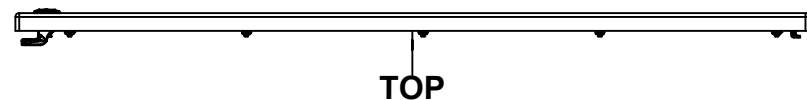

TOP

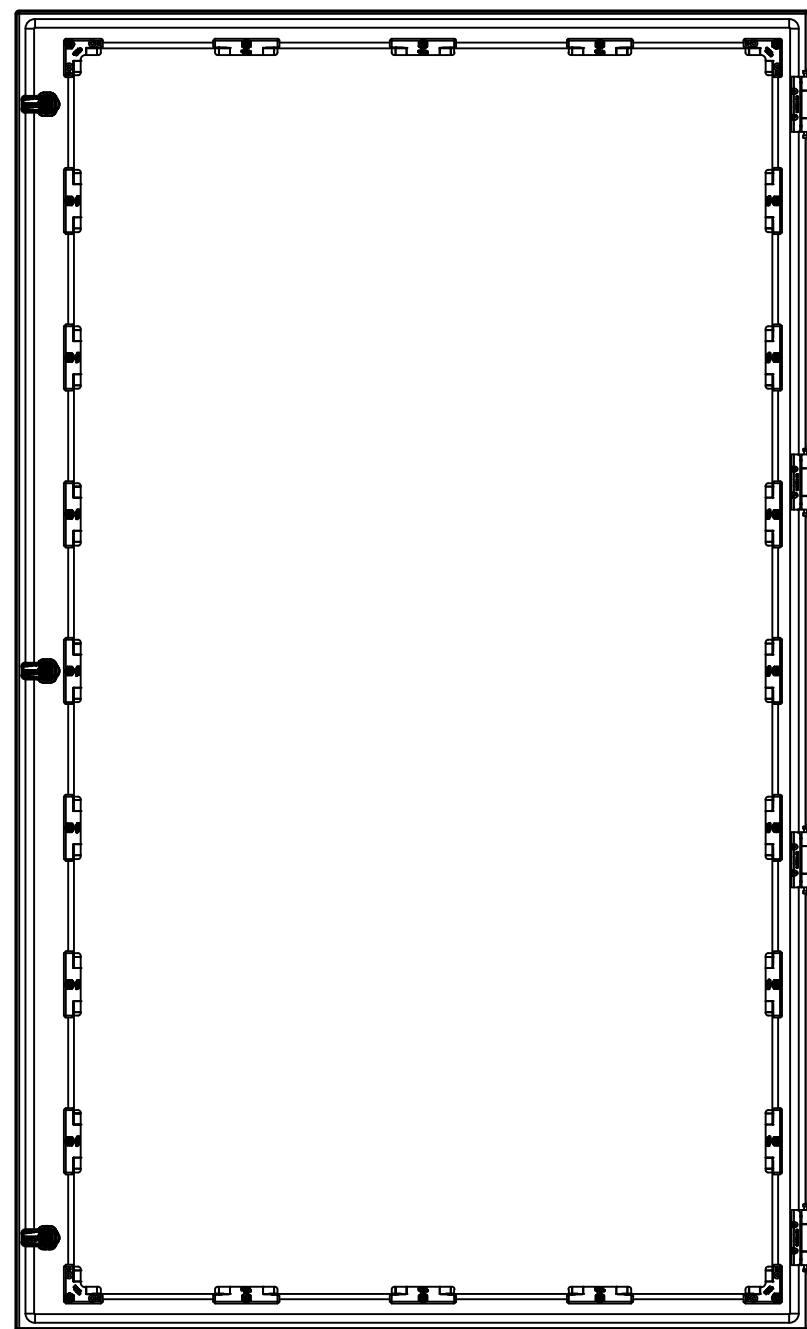

BACK



BOTTOM

0.000
0.800

LEFT

0.000

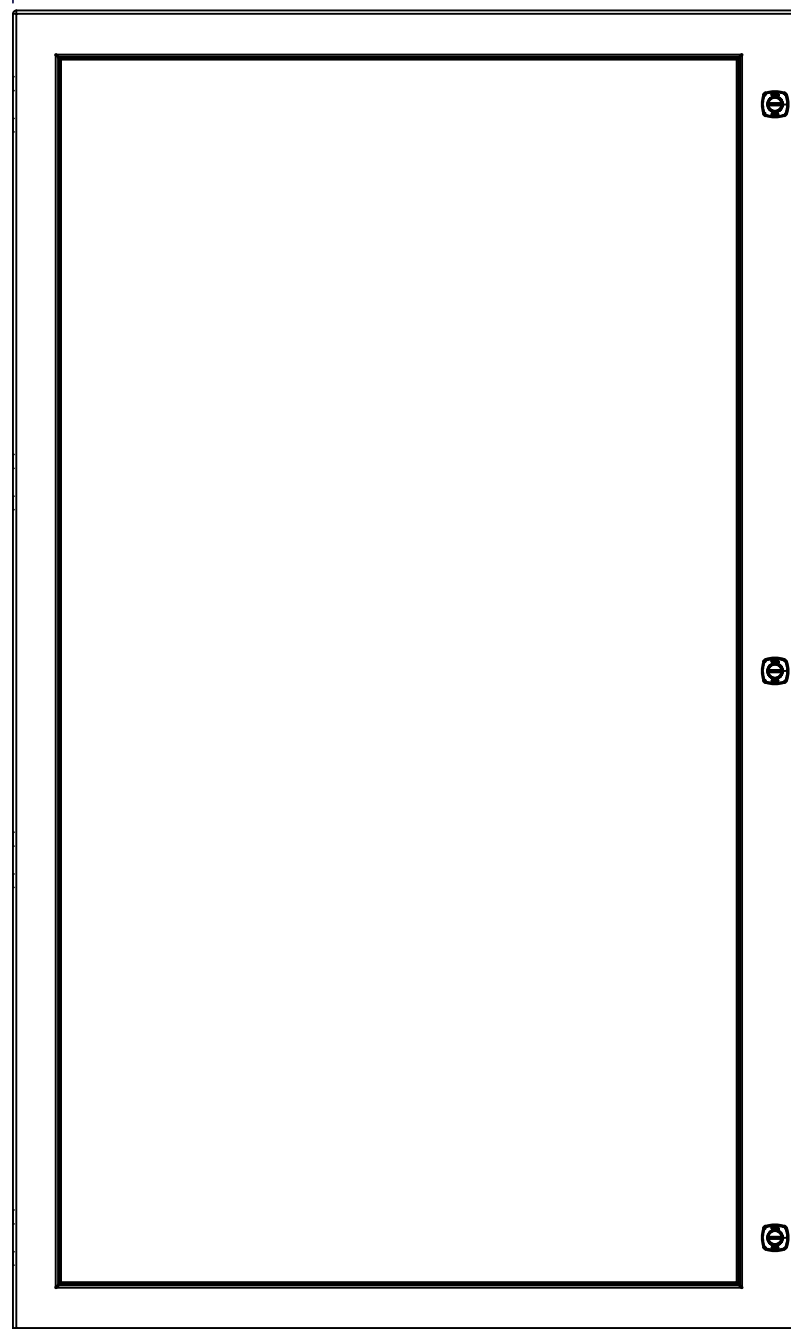

FRONT

35.918

59.803

RIGHT

0.000

| No. | Revisions | Date | By/Par |
|-----|-----------|------|--------|
| | | | |
| | | | |
| | | | |
| | | | |

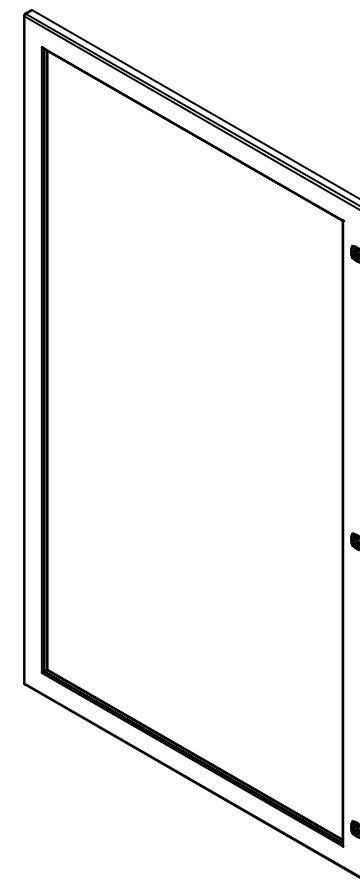

Isometric View



Tél: (450) 979-4373
Fax: (450) 979-4626
www.exmweb.com

Flatness
Aplatissement

Max 3.0mm

Projection



| | |
|---|----------------|
| Customer Client | Date |
| Drawn By Dessiné Par BoxCad: BoxCad | Date 06-Jun-23 |
| Material Matière 14 Ga Stainless Steel 316 (1.7mm) | |

| | |
|----------------------------|------------------------|
| Color Couleur Unpainted | Finish Fini Brushed |
|----------------------------|------------------------|

| | |
|---|-------------|
| Description 5412ESSW 60" x 36" Cover | Detail Rev. |
|---|-------------|

| | | |
|-----------------------------|------|----|
| Part Number Numéro Pièce | Rev. | 8 |
| 5412ESSW6036086THC | 0 | 15 |

SEE BILL OF MATERIAL ON LAST PAGE

This drawing is confidential and must not be reproduced or used without the consent of EXM

Ce dessin est confidentiel et ne doit pas être reproduit ou utilisé sans le consentement de EXM

STANDARD FEATURES ARE NOT LISTED IN THIS HOLE TABLE

HOLE TABLE - FRONT VIEW (CUSTOM FEATURE ONLY)

| CUT-OUT | XDIM | YDIM | DESCRIPTION |
|---------|--------|--------|-------------------------|
| 1 | 1.469 | 8.621 | STUD M6 x 18mm (Inside) |
| 2 | 33.468 | 8.621 | STUD M6 x 18mm (Inside) |
| 3 | 1.469 | 15.714 | STUD M6 x 18mm (Inside) |
| 4 | 33.468 | 15.714 | STUD M6 x 18mm (Inside) |
| 5 | 1.469 | 22.808 | STUD M6 x 18mm (Inside) |
| 6 | 33.468 | 22.808 | STUD M6 x 18mm (Inside) |
| 7 | 1.469 | 29.902 | STUD M6 x 18mm (Inside) |
| 8 | 33.468 | 29.902 | STUD M6 x 18mm (Inside) |
| 9 | 1.469 | 36.995 | STUD M6 x 18mm (Inside) |
| 10 | 33.468 | 36.995 | STUD M6 x 18mm (Inside) |
| 11 | 1.469 | 44.089 | STUD M6 x 18mm (Inside) |
| 12 | 33.468 | 44.089 | STUD M6 x 18mm (Inside) |
| 13 | 1.469 | 51.182 | STUD M6 x 18mm (Inside) |
| 14 | 33.468 | 51.182 | STUD M6 x 18mm (Inside) |
| 15 | 1.469 | 58.276 | STUD M6 x 18mm (Inside) |
| 16 | 1.469 | 1.527 | STUD M6 x 18mm (Inside) |
| 17 | 9.469 | 58.276 | STUD M6 x 18mm (Inside) |
| 18 | 9.469 | 1.527 | STUD M6 x 18mm (Inside) |
| 19 | 17.469 | 58.276 | STUD M6 x 18mm (Inside) |
| 20 | 17.469 | 1.527 | STUD M6 x 18mm (Inside) |
| 21 | 25.468 | 58.276 | STUD M6 x 18mm (Inside) |
| 22 | 25.468 | 1.527 | STUD M6 x 18mm (Inside) |
| 23 | 33.468 | 58.276 | STUD M6 x 18mm (Inside) |
| 24 | 33.468 | 1.527 | STUD M6 x 18mm (Inside) |
| ----- | | | |
| 25 | 34.494 | 55.553 | 880 SCQ4-SLSS6 |
| 26 | 34.494 | 29.902 | 880 SCQ4-SLSS6 |
| 27 | 34.494 | 4.250 | 880 SCQ4-SLSS6 |

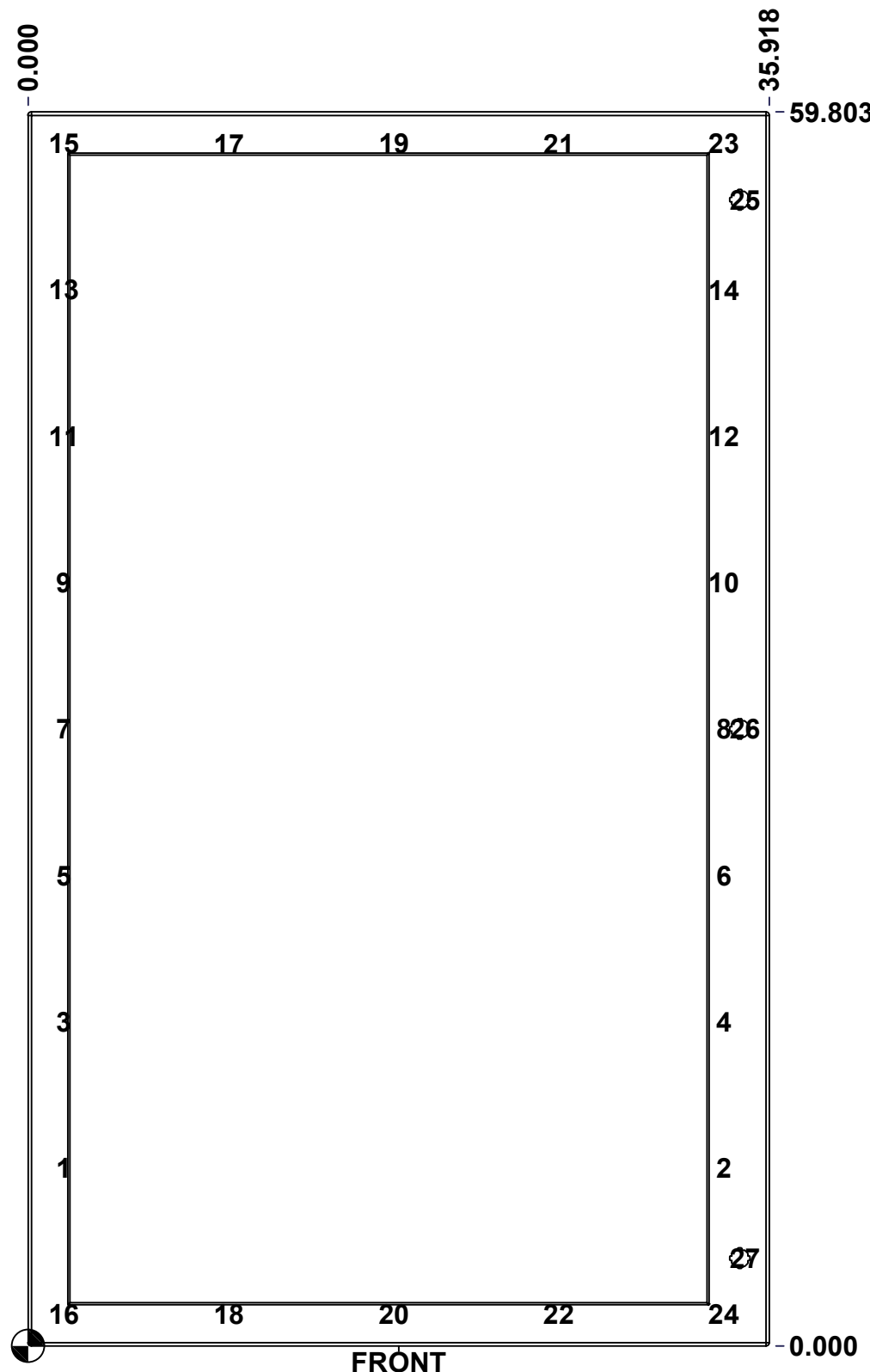

| | | |
|--|--------------------------|--------|
| | Description | Status |
| | 5412ESSW 60" x 36" Cover | (NULL) |
| Part Number Numéro Pièce 5412ESSW6036086THC | Rev. | 9 |
| | 0 | 15 |

This drawing is confidential and must not be reproduced or used without the consent of EXM

Ce dessin est confidentiel et ne doit pas être reproduit ou utilisé sans le consentement de EXM

| No. | Revisions | Date | By/Par |
|-----|-----------|------|--------|
| | | | |
| | | | |
| | | | |
| | | | |
| | | | |

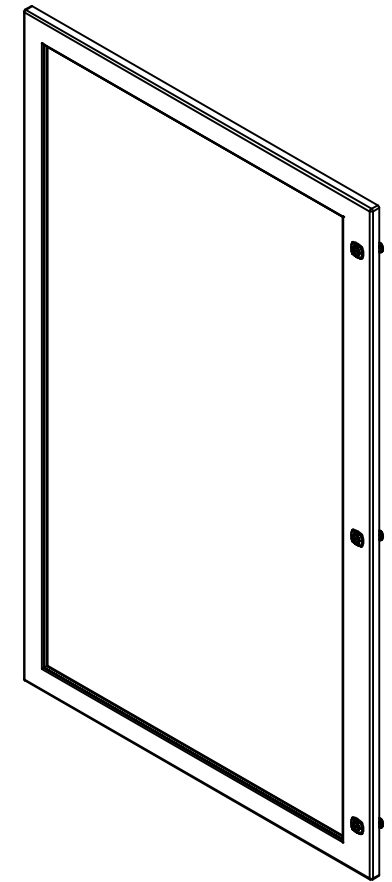

Isometric View

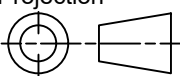

| | | | |
|------------|--------------------------|-----|---------------------------------------|
| 20 | STK-Q-60701 | 2.1 | 880 WK - Lexan 1/4" Fixing Bracket |
| 1 | STK-A-60703 | 0 | 5412 ESW Lexan Bracket Kit |
| 24 | STK-Q-16053 | 1 | Stud M6 x 23mm Stainless steel |
| 1 | STK-G-02710 | 0 | 880 HWKG - Windows Kit Gasket |
| 1 | 5412ESSW6036086THLX G | 0 | 5412ESSW 60" x 36" Lexan Gasket Part |
| 1 | 5412ESSW6036086THLX | 0 | 5412ESSW 56.375" x 32.125" Lexan Part |
| 1 | 5412ESSW6036086THG | 0 | 5412ESSW 60" x 36" Cover Gasket Part |
| 1 | 5412ESSW6036086THC- P | 0 | 5412ESSW 60" x 36" Cover Part |
| 3 | 880 SCQ4-SLSS6 | 7 | 5412 ESS 1/4 Turn Lock |
| 4 | STK-A-33016 | 0 | 5412 ESS Bended Hinge (Body Part) |
| QTY | Part Number | Rev | Description |
| Parts List | | | |

| | | |
|--|-----------------------------------|---|
|  Tél: (450) 979-4373 Fax: (450) 979-4626 www.exmweb.com | | Flatness Aplatissement Max 3.0mm Projection  |
| Customer Client | Date | |
| Drawn By Dessiné Par | BoxCad: BoxCad | Date 06-Jun-23 |
| Material Matière | 14 Ga Stainless Steel 316 (1.7mm) | |
| Color Couleur | Unpainted | Finish Fini Brushed |
| Description | | Detail Rev. |
| 5412ESSW 60" x 36" Cover | | |
| Part Number Numéro Pièce | Rev. | 10 |
| 5412ESSW6036086THC | 0 | 15 |

This drawing is confidential and must not be reproduced or used without the consent of EXM

Ce dessin est confidentiel et ne doit pas être reproduit ou utilisé sans le consentement de EXM

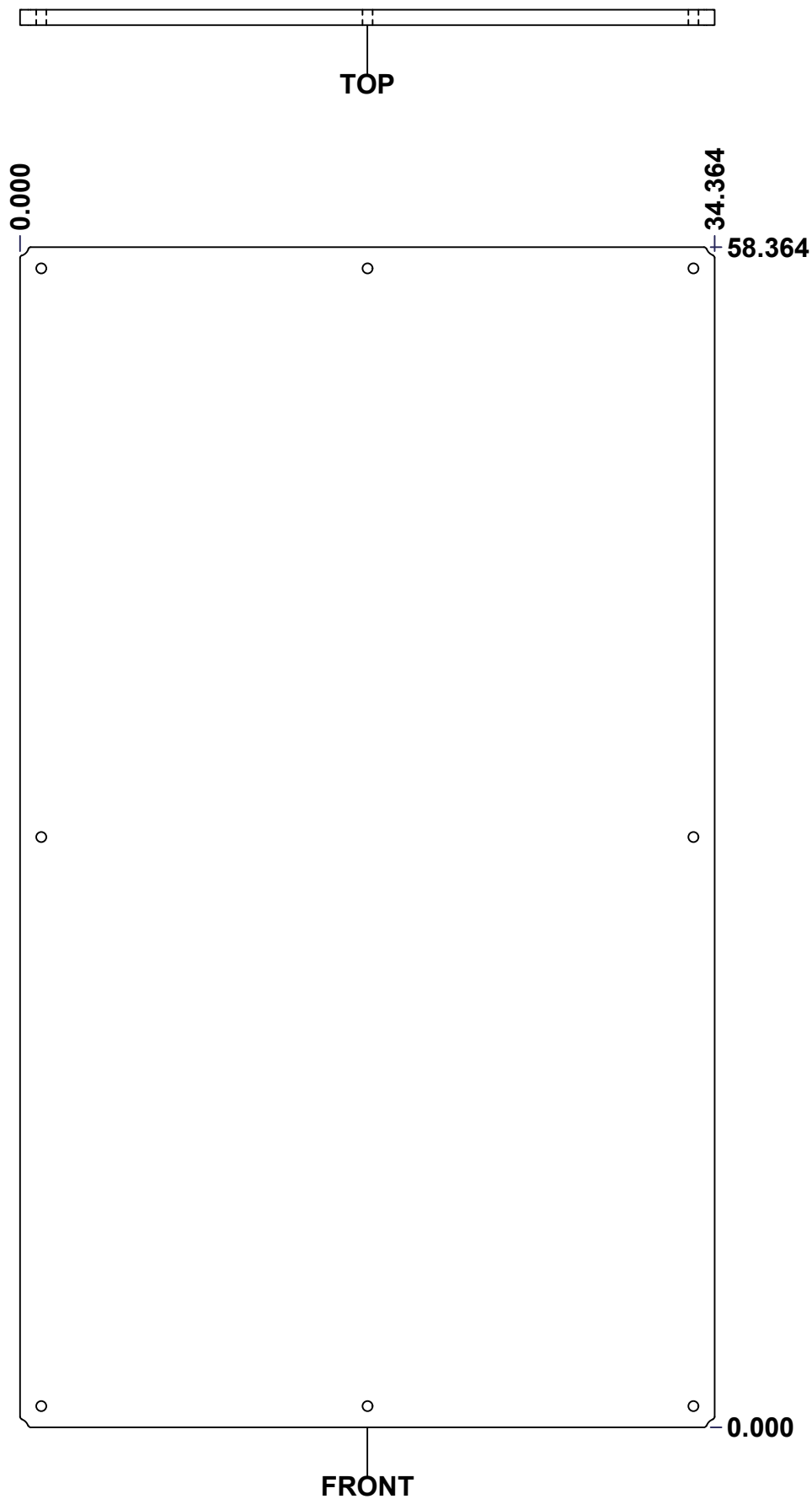

| No. | Revisions | Date | By/Par |
|-----|-----------|------|--------|
| | | | |
| | | | |
| | | | |
| | | | |

Isometric View

| | | |
|---|---------------------------|--|
| <p>Tél: (450) 979-4373 Fax: (450) 979-4626 www.exmweb.com</p> | | Flatness Aplatissement Max 3.0mm Projection |
| Customer Client | Date | |
| Drawn By Dessiné Par | BoxCad: Patrick Deschenes | Date 23-Jan-07 |
| Material Matière | Polyisocyanurate | |
| Color Couleur | Aluminum | Finish Fini N/A |
| Description | Detail Rev. | |
| 5412ESSW 60" x 36" Back Insulation | | |
| Part Number Numéro Pièce | Rev. | 11 |
| 5412ESSW6036086THI-B | 0 | 15 |

SEE BILL OF MATERIAL ON LAST PAGE

This drawing is confidential and must not be reproduced or used without the consent of EXM

Ce dessin est confidentiel et ne doit pas être reproduit ou utilisé sans le consentement de EXM

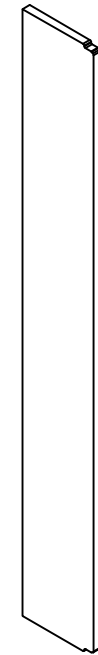
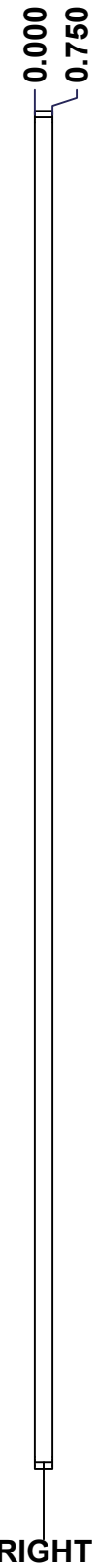
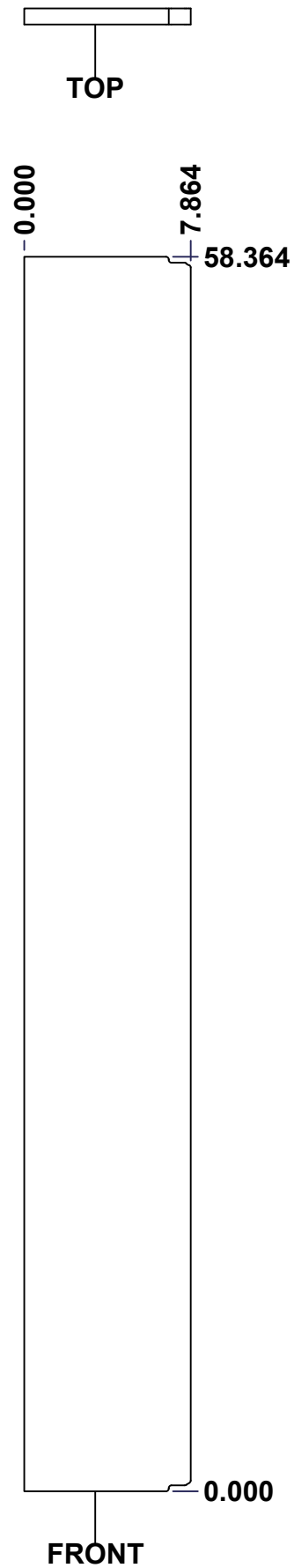

Isometric View



Tél: (450) 979-4373
 Fax: (450) 979-4626
www.exmweb.com

Flatness
Aplatissement

Max 3.0mm

Projection

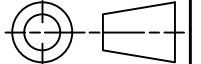

| | |
|-------------------------|------------------|
| Customer Client | Date |
| Drawn By Dessiné Par | Date 23-Jan-07 |
| Material Matière | Polyisocyanurate |
| Color Couleur | Aluminum |
| Finish Fini | N/A |

| | |
|------------------------------------|-------------|
| Description | Detail Rev. |
| 5412ESSW 60" x 36" Left Insulation | |

| | | |
|-----------------------------|----------|----|
| Part Number Numéro Pièce | Rev. | 12 |
| 5412ESSW6036086TH-LS | 0 | 15 |

SEE BILL OF MATERIAL ON LAST PAGE

This drawing is confidential and must not be reproduced or used without the consent of EXM

Ce dessin est confidentiel et ne doit pas être reproduit ou utilisé sans le consentement de EXM

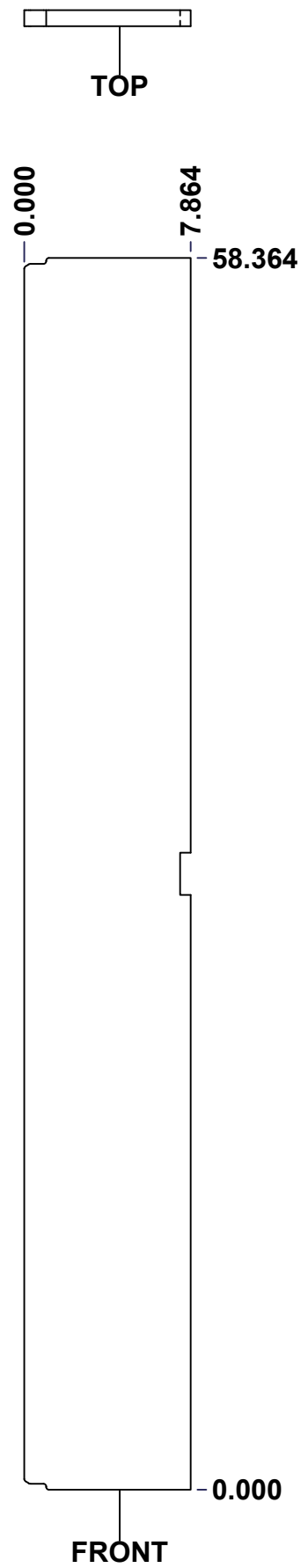

| No. | Revisions | Date | By/Par |
|-----|-----------|------|--------|
| | | | |
| | | | |
| | | | |
| | | | |
| | | | |

Isometric View

| | | |
|--|---------------------------|--|
| Tél: (450) 979-4373 Fax: (450) 979-4626 www.exmweb.com | | Flatness Aplatissement Max 3.0mm |
| Projection | | Date 23-Jan-07 |
| Customer Client | Date | |
| Drawn By Dessiné Par | BoxCad: Patrick Deschenes | Date 23-Jan-07 |
| Material Matière | Polyisocyanurate | |
| Color Couleur | Aluminum | Finish Fini N/A |
| Description | Detail Rev. | |
| 5412ESSW 60" x 36" Right Insulation | | |
| Part Number Numéro Pièce | Rev. | 13 |
| 5412ESSW6036086THI-RS | 0 | 15 |

SEE BILL OF MATERIAL ON LAST PAGE

This drawing is confidential and must not be reproduced or used without the consent of EXM

Ce dessin est confidentiel et ne doit pas être reproduit ou utilisé sans le consentement de EXM



TOP

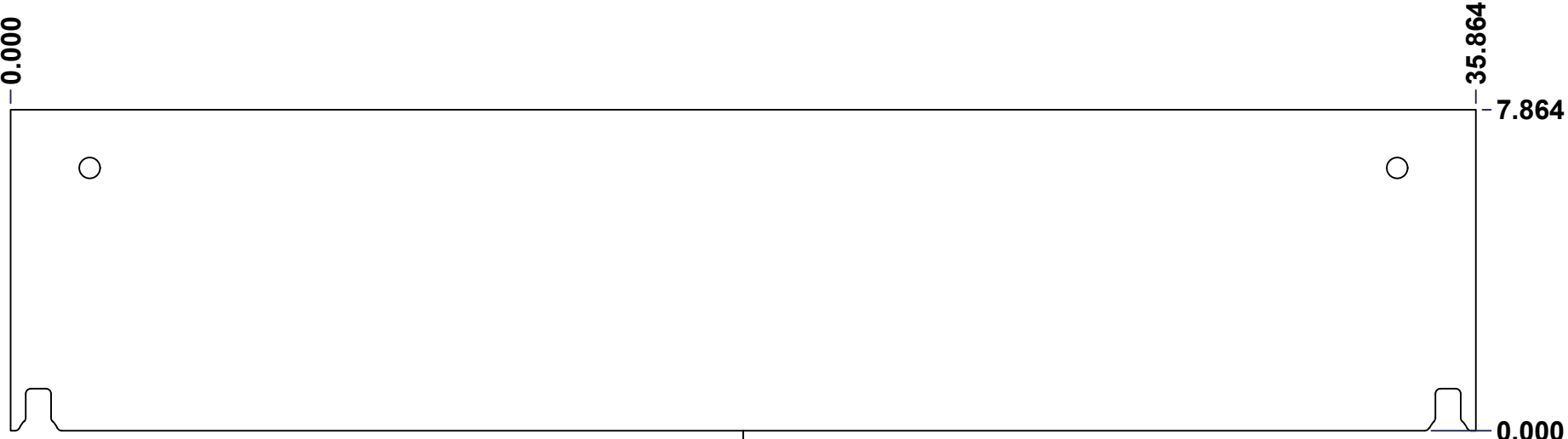

FRONT

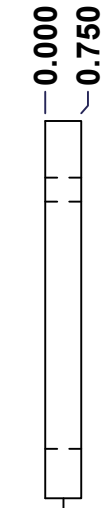

RIGHT

| No. | Revisions | Date | By/Par |
|-----|-----------|------|--------|
| | | | |
| | | | |
| | | | |
| | | | |

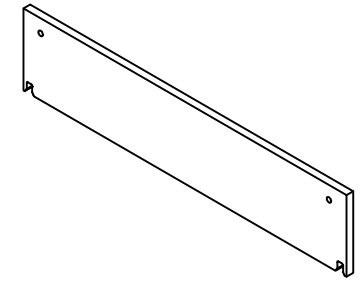

Isometric View



Tél: (450) 979-4373
 Fax: (450) 979-4626
www.exmweb.com

Flatness
 Aplatissement
 Max 3.0mm
 Projection

| | |
|---|--------------------|
| Customer Client | Date |
| Drawn By / Dessiné Par: BoxCad: Patrick Deschenes | Date: 23-Jan-07 |
| Material / Matière: Polyisocyanurate | |
| Color / Couleur: Aluminum | Finish / Fini: N/A |
| Description: 5412ESSW 60" x 36" Top and Bottom Insulation | Detail Rev. |
| Part Number / Numéro Pièce: 5412ESSW6036086THI-TP | Rev. 0 |

SEE BILL OF MATERIAL ON LAST PAGE

This drawing is confidential and must not be reproduced or used without the consent of EXM

Ce dessin est confidentiel et ne doit pas être reproduit ou utilisé sans le consentement de EXM



TOP

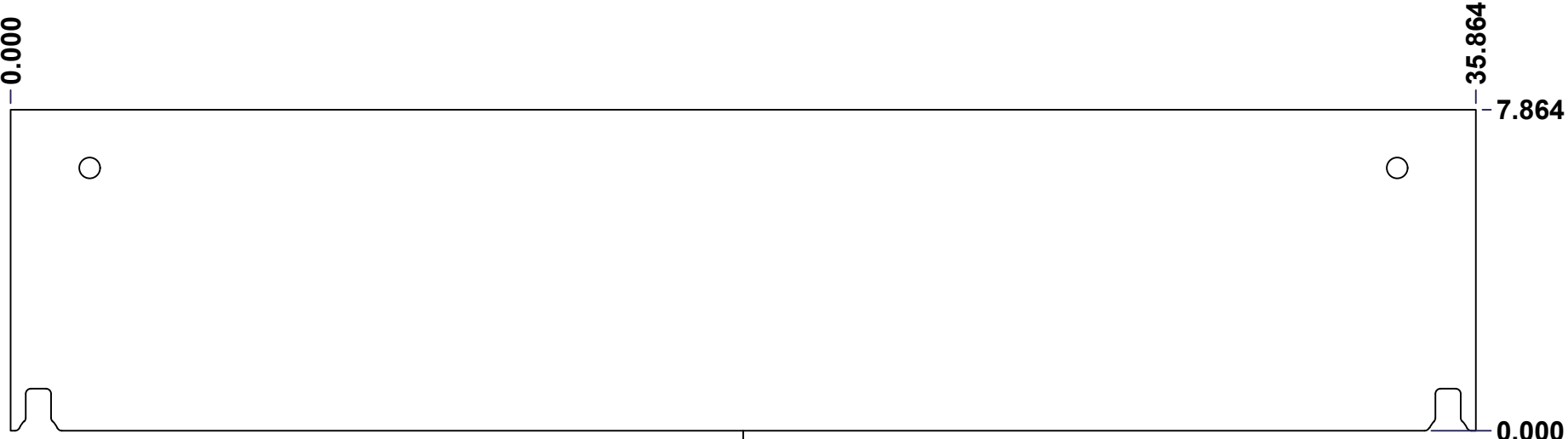

FRONT

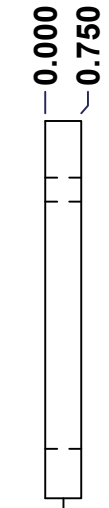

RIGHT

| No. | Revisions | Date | By/Par |
|-----|-----------|------|--------|
| | | | |
| | | | |
| | | | |
| | | | |
| | | | |

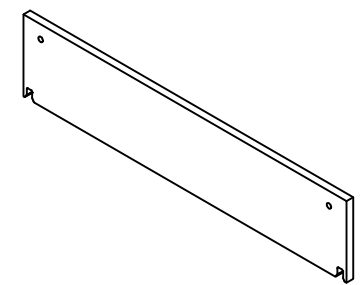

Isometric View



Tél: (450) 979-4373
 Fax: (450) 979-4626
www.exmweb.com

Flatness
 Aplatissement
 Max 3.0mm
 Projection

| | |
|---|--------------------|
| Customer Client | Date |
| Drawn By / Dessiné Par: BoxCad: Patrick Deschenes | Date: 23-Jan-07 |
| Material / Matière: Polyisocyanurate | |
| Color / Couleur: Aluminum | Finish / Fini: N/A |
| Description: 5412ESSW 60" x 36" Top and Bottom Insulation | Detail Rev. |
| Part Number / Numéro Pièce: 5412ESSW6036086THI-BT | Rev. 0 |

SEE BILL OF MATERIAL ON LAST PAGE

This drawing is confidential and must not be reproduced or used without the consent of EXM

Tolerance ±1/32" unless otherwise specified

C:\Vault Workspace\Inventor Dwg\Inv-8\881SP\881SP6036G.idw

Tolérance ±1/32" sauf spécification contraire

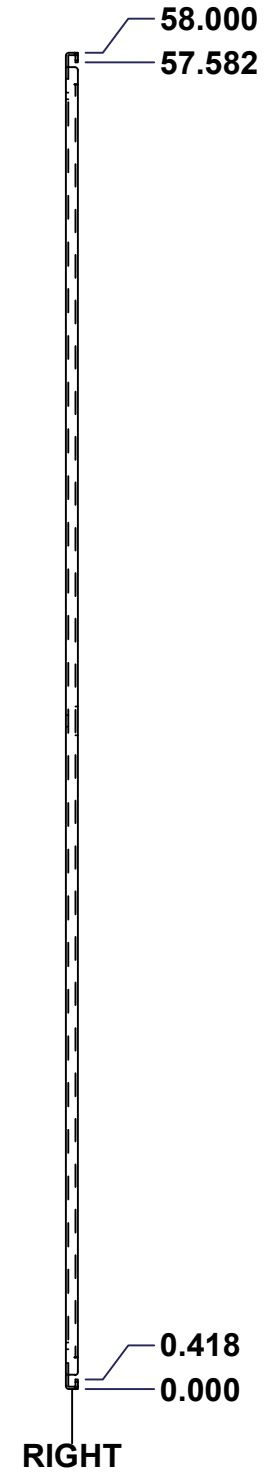
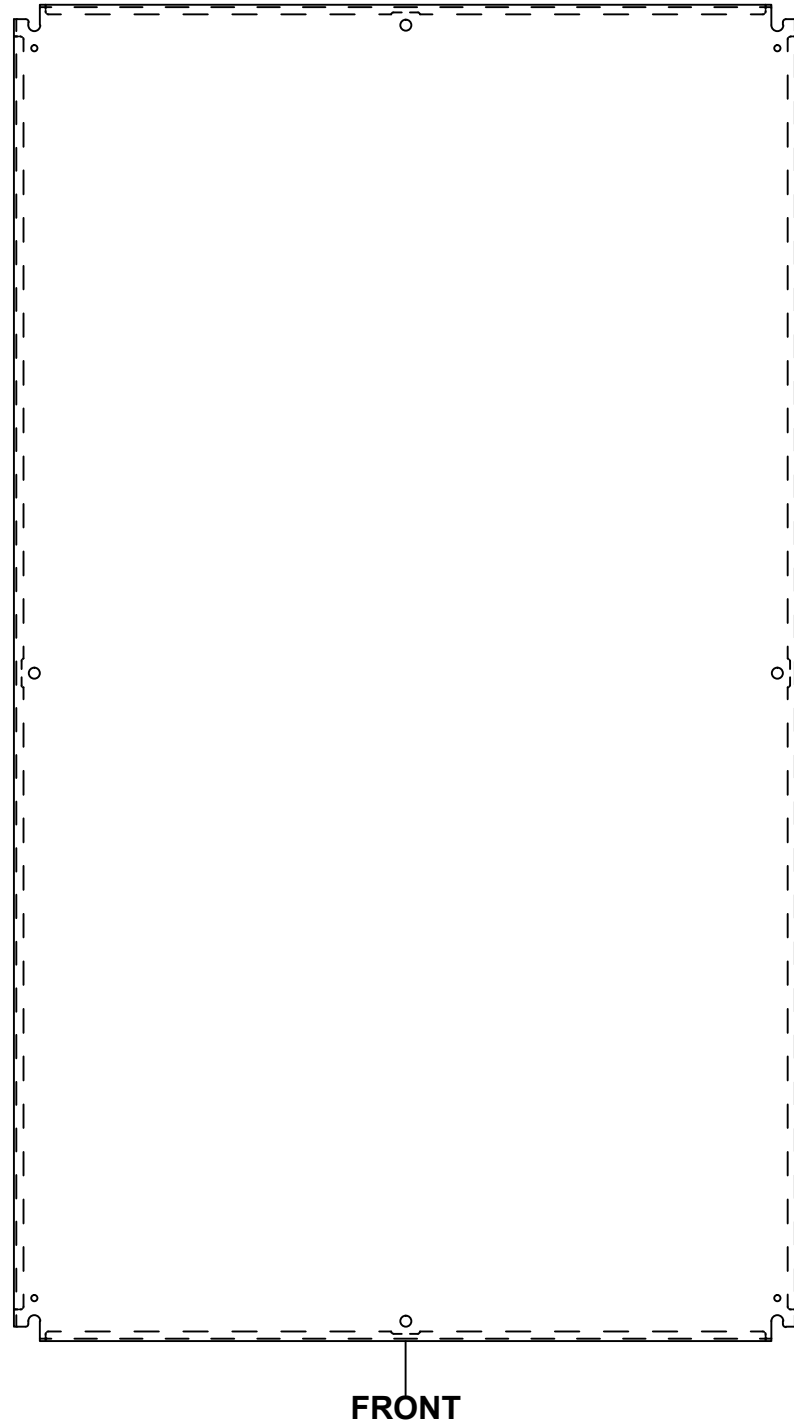
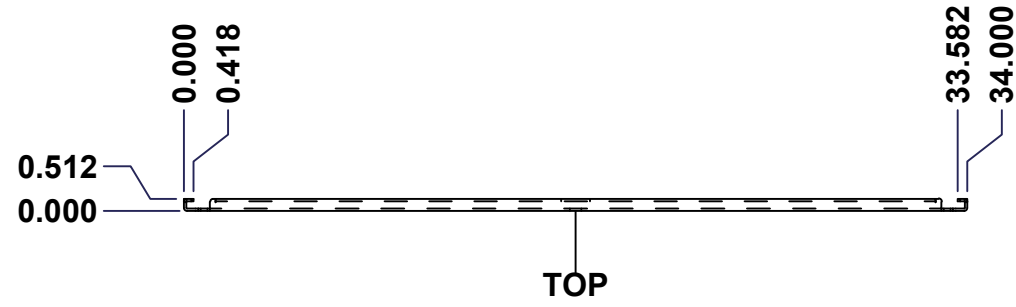

| No. | Revisions | Date | By/Par |
|-----|-----------|------|--------|
| | | | |
| | | | |
| | | | |
| | | | |
| | | | |

Isometric View

| | | |
|--|-----------------|--|
| Tél: (450) 979-4373 Fax: (450) 979-4626 www.exmweb.com | | Flatness Aplatissement Max 3.0mm Projection |
| Customer Client | Date | |
| Drawn By Dessiné Par: BoxCad | Date: 23-Jan-07 | |
| Material Matière | See Part List | |
| Color Couleur | See Part List | Finish Fini: See Part List |
| Description | Detail Rev. | |
| 881 SP - Inner Panel | | |
| Part Number Numéro Pièce: 881 SP6036G | Rev. 0 | 1 2 |

| Qty | Part Number | Rev | Description | Material | Color | Finish |
|-----|---------------|-----|---------------------------|------------------|-----------|------------|
| 1 | 881 SP6036G-P | 0 | 881 SP - Inner Panel Part | 12 Ga Galvanized | Unpainted | Galvanized |

Parts List

Ce dessin est confidentiel et ne doit pas être reproduit ou utilisé sans le consentement de EXM

This drawing is confidential and must not be reproduced or used without the consent of EXM

Ce dessin est confidentiel et ne doit pas être reproduit ou utilisé sans le consentement de EXM

| Table 1 | | | FRONT VIEW |
|---------|--------|--------|----------------------------|
| CUT-OUT | XDIM | YDIM | DESCRIPTION |
| 1 | 17.000 | 0.875 | MTG STUD HOLE (RND Ø0.500) |
| 2 | 0.875 | 29.000 | MTG STUD HOLE (RND Ø0.500) |
| 3 | 33.125 | 29.000 | MTG STUD HOLE (RND Ø0.500) |
| 4 | 17.000 | 57.125 | MTG STUD HOLE (RND Ø0.500) |
| 5 | 0.875 | 1.875 | GROUND HOLE (RND Ø0.290) |
| 6 | 33.125 | 1.875 | GROUND HOLE (RND Ø0.290) |
| 7 | 0.875 | 56.125 | GROUND HOLE (RND Ø0.290) |
| 8 | 33.125 | 56.125 | GROUND HOLE (RND Ø0.290) |

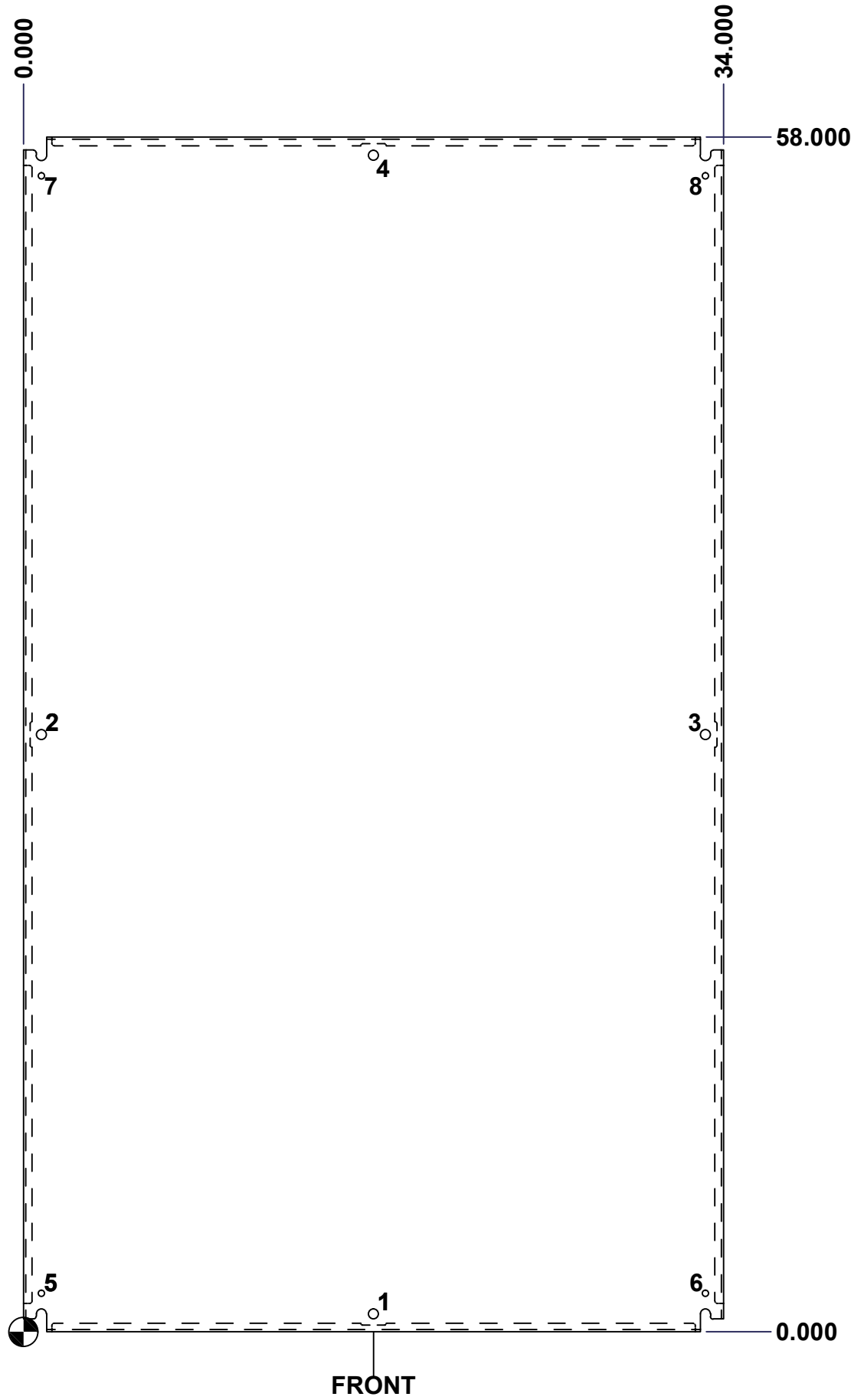

All knockouts are actual size / Les disques défonçables sont grandeur réel

| No. | Revisions | Date | By/Par |
|-----|-----------|------|--------|
| | | | |
| | | | |
| | | | |
| | | | |
| | | | |
| | | | |

Isometric View

| | | | | | |
|---|--|--|--|--|--|
| | | Tél: (450) 979-4373 Fax: (450) 979-4626 www.exmweb.com | | Flatness Aplatissement Max 3.0mm | |
| Customer Client | | Date | | Projection | |
| Drawn By Dessiné Par | | BoxCad | | Date 23-Jan-07 | |
| Material Matière | | See Part List | | | |
| Color Couleur | | See Part List | | Finish Fini | |
| Description 881 SP - Inner Panel | | | | Detail Rev. | |
| Part Number Numéro Pièce 881 SP6036G | | | | Rev. 2 0 | |