

This drawing is confidential and must not be reproduced or used without the consent of EXM

Ce dessin est confidentiel et ne doit pas être reproduit ou utilisé sans le consentement de EXM

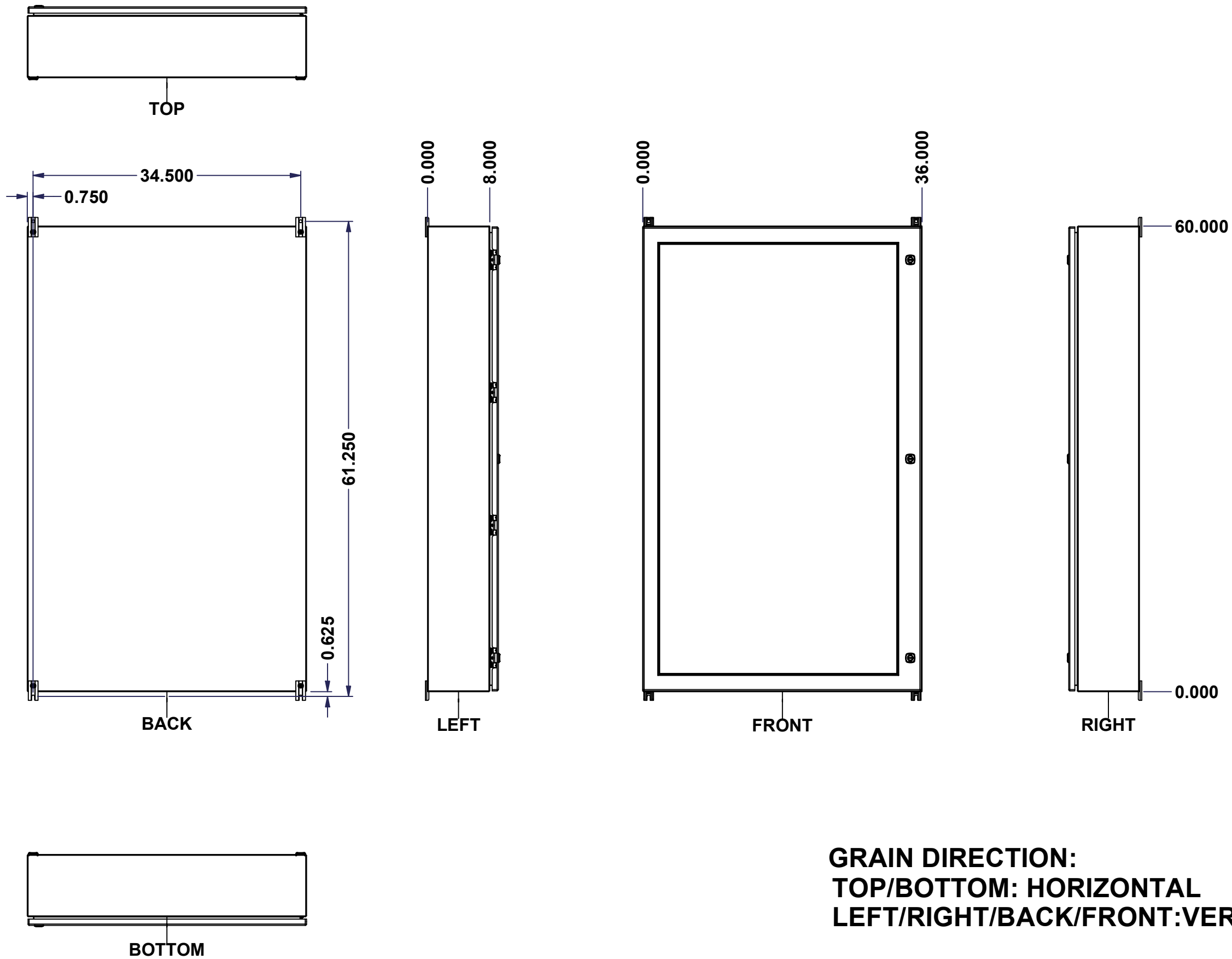

**GRAIN DIRECTION:  
TOP/BOTTOM: HORIZONTAL  
LEFT/RIGHT/BACK/Front: VERTICAL**

No.	Revisions	Date	By/Par

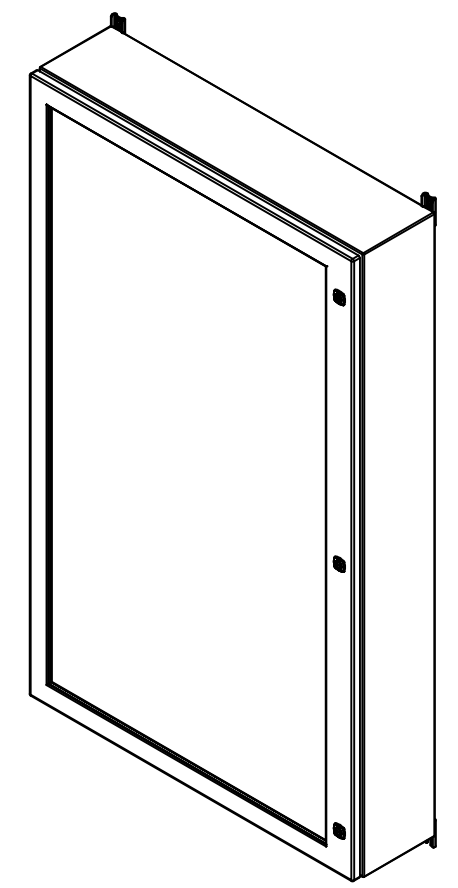

Isometric View



	Tél: (450) 979-4373 Fax: (450) 979-4626 <a href="http://www.exmweb.com">www.exmweb.com</a>	Flatness Aplatissement Max 3.0mm Projection 
	Customer Client Drawn By / Dessiné Par: BoxCad: BoxCad Material Matière: 14 Ga Stainless Steel 304 (1.7mm) Color Couleur: Unpainted Finish Fini: Brushed	Date Date: 06-Jun-23
Description: 5412ESSW 60" x 36" x 8" Assembly		Part Number / Numéro Pièce: <b>5412ESSW603608TH</b>

SEE BILL OF MATERIAL ON LAST PAGE

This drawing is confidential and must not be reproduced or used without the consent of EXM

Ce dessin est confidentiel et ne doit pas être reproduit ou utilisé sans le consentement de EXM

NOTE	
ITEM	DESCRIPTION
1	NEMA 4X Enclosure
2	C/W Standard ground studs on box and cover
3	W/O Standard door stiffener
4	C/W Standard inner panel (Included)
5	C/W Standard inner panel mounting studs
6	C/W 885 ESMF4_OPEN Sold separately (Installed)
7	C/W 885 ESMF4_CLOSE Sold separately (Installed)
8	C/W R5 Insulation (Installed by EXM)

No.	Revisions	Date	By/Par

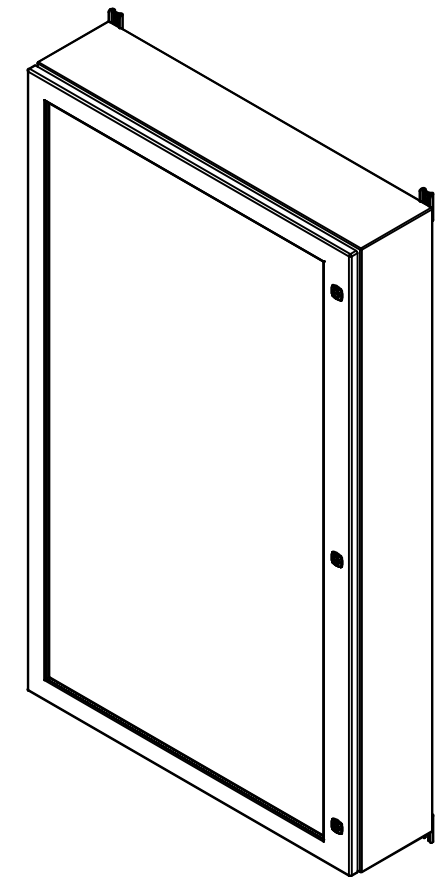

Isometric View

PACKING		
ITEM	QTY	DESCRIPTION
Cardboard sleeve	2	Top and Bottom
Cardboard strip	2	Between back of enclosure and inner panel
Plastic bag	1	To protect cover surface and inside gasket
Cardboard corner	4	To reinforced for the plastic strap tightening
Plastic strap - Black	2	To Squeeze the 2 cardboard sleeve together
Packaging label	3	White label with PN
Plastic strap- Green	2	To secure the enclosure to the wood pallet
Wood Pallet	1	2" deeper and 3" larger than enclosure size

8	STK-Q-00600	2	M12 to M8 Adaptor
1	881 SP6036G	0	881 SP - Inner Panel
1	STK-K-01800	5	5412 ES Accessory Kit
1	5412ESSW603608THC	0	5412ESSW 60" x 36" Cover
1	5412ESSW603608THB	0	5412ESSW 60" x 36" x 8" Body
4	STK-Q-04051-08	1	M6 x 8mm Stainless Steel Hexagon Socket Head Machine Screw with Nyseal
Qty	Part Number	Rev	Description
Parts List			

	Tél: (450) 979-4373 Fax: (450) 979-4626 <a href="http://www.exmweb.com">www.exmweb.com</a>	Flatness Aplatissement Max 3.0mm Projection 
	Customer Client Drawn By Dessiné Par Material Matière Color Couleur Description Part Number Numéro Pièce	Date Date 06-Jun-23 14 Ga Stainless Steel 304 (1.7mm) Unpainted Finish Brushed 5412ESSW 60" x 36" x 8" Assembly <b>5412ESSW603608TH</b>

This drawing is confidential and must not be reproduced or used without the consent of EXM

Ce dessin est confidentiel et ne doit pas être reproduit ou utilisé sans le consentement de EXM

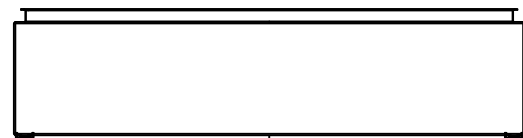

TOP

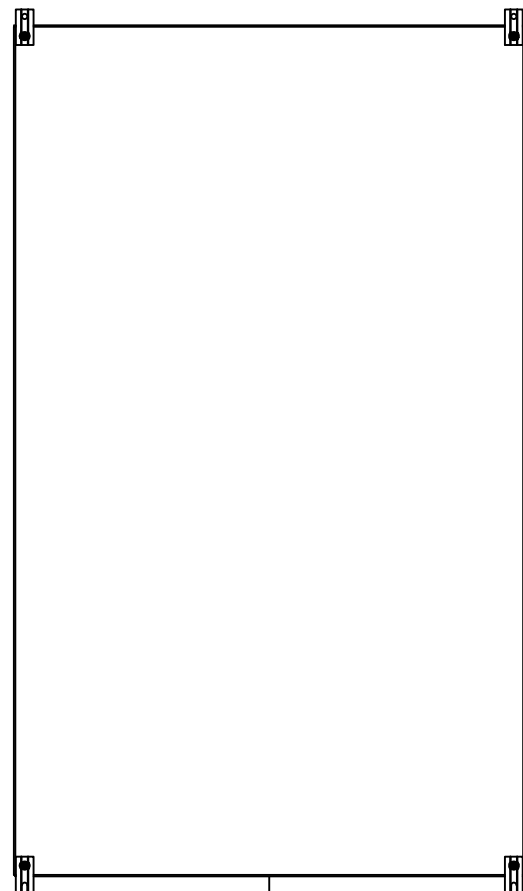

BACK

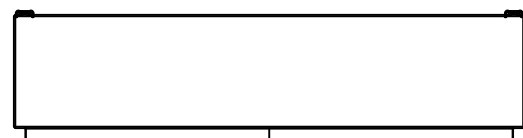

BOTTOM

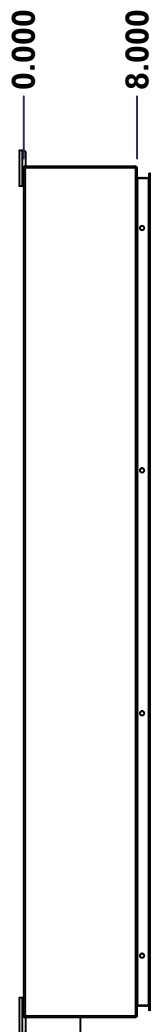

LEFT

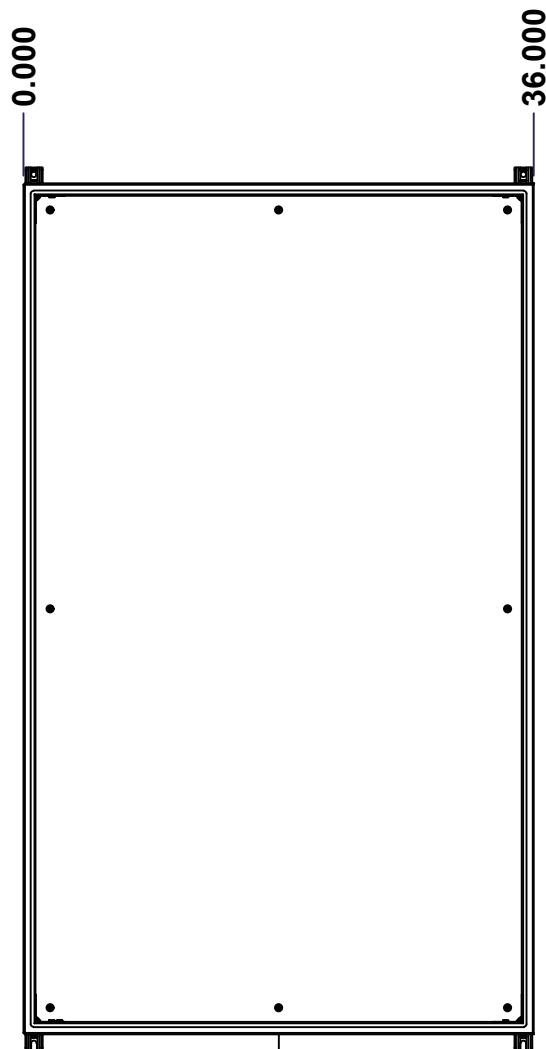

FRONT

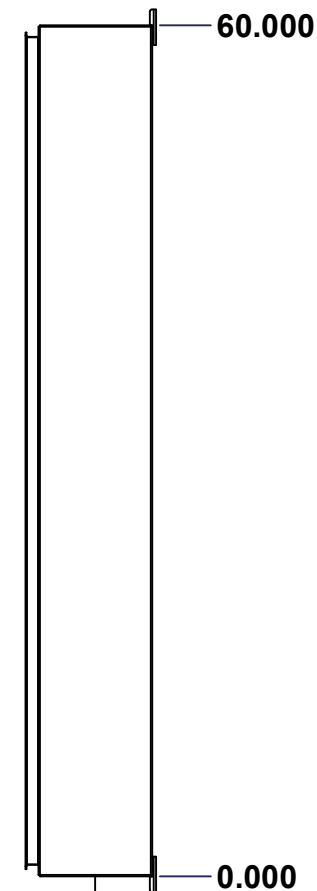

RIGHT

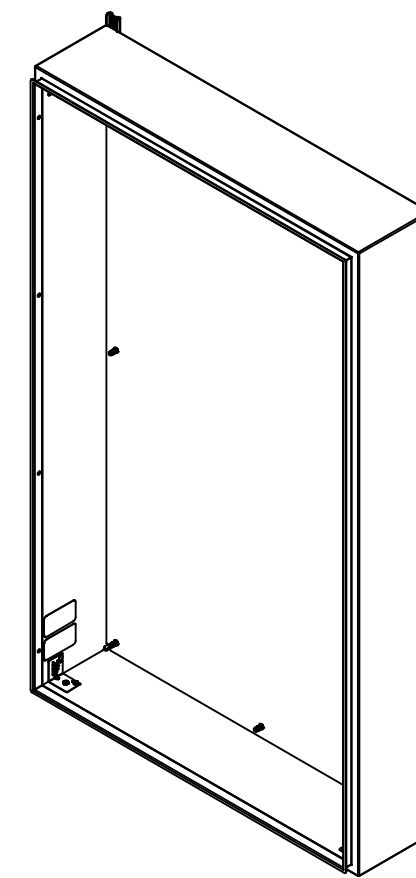

Isometric View

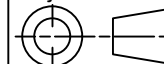

No.	Revisions	Date	By/Par

 Tél: (450) 979-4373 Fax: (450) 979-4626 <a href="http://www.exmweb.com">www.exmweb.com</a>		Flatness Aplatissement  Max 3.0mm Projection 
Customer Client	Date	
Drawn By Dessiné Par	BoxCad: BoxCad	Date 06-Jun-23
Material Matière	14 Ga Stainless Steel 304 (1.7mm)	
Color Couleur	Unpainted	Finish Fini Brushed
Description	Detail Rev.	
5412ESSW 60" x 36" x 8" Body		
Part Number Numéro Pièce	Rev.	3
5412ESSW603608THB	0	15

SEE BILL OF MATERIAL ON LAST PAGE

This drawing is confidential and must not be reproduced or used without the consent of EXM

Ce dessin est confidentiel et ne doit pas être reproduit ou utilisé sans le consentement de EXM

STANDARD FEATURES ARE NOT LISTED IN THIS HOLE TABLE			
HOLE TABLE - TOP VIEW (CUSTOM FEATURE ONLY)			
CUT-OUT	XDIM	YDIM	DESCRIPTION
1	2.000	6.500	INSUL. STUD M6 x 18mm (Inside)
2	34.000	6.500	INSUL. STUD M6 x 18mm (Inside)

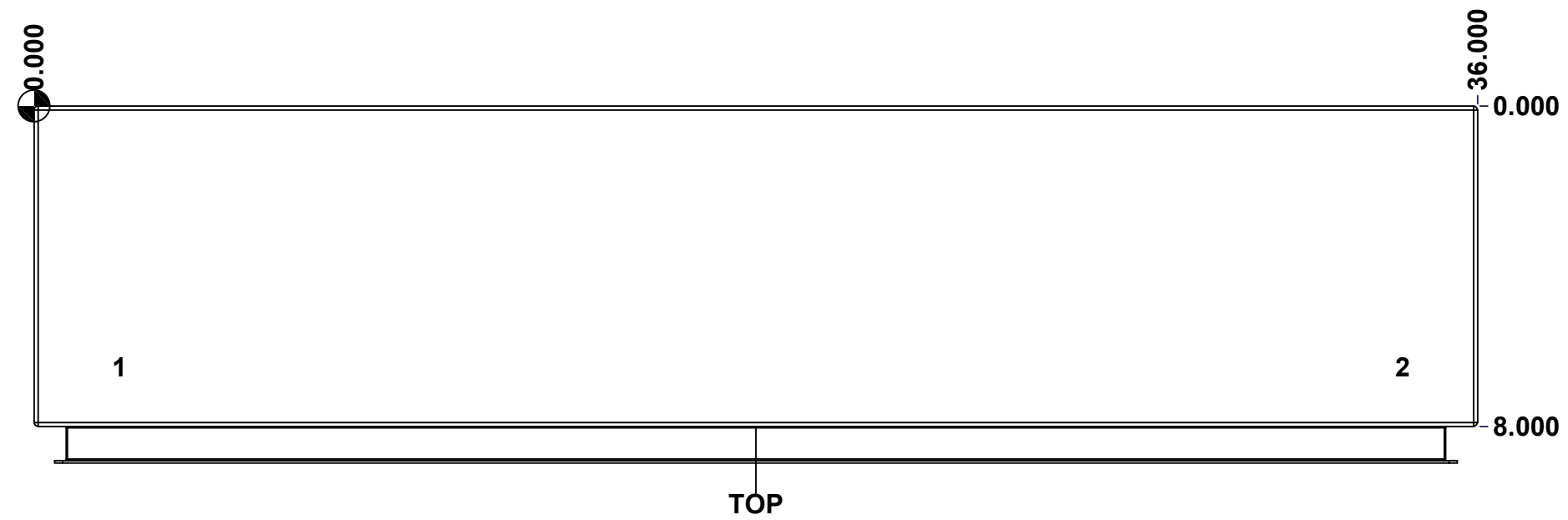

	Description	Status
	5412ESSW 60" x 36" x 8" Body	(NULL)
	Part Number Numéro Pièce	Rev.
	<b>5412ESSW603608THB</b>	<b>0</b>
		4
		15

This drawing is confidential and must not be reproduced or used without the consent of EXM

Ce dessin est confidentiel et ne doit pas être reproduit ou utilisé sans le consentement de EXM

<b>STANDARD FEATURES ARE NOT LISTED IN THIS HOLE TABLE</b>			
<b>HOLE TABLE - BOTTOM VIEW (CUSTOM FEATURE ONLY)</b>			
CUT-OUT	XDIM	YDIM	DESCRIPTION
1	2.000	6.500	INSUL. STUD M6 x 18mm (Inside)
2	34.000	6.500	INSUL. STUD M6 x 18mm (Inside)

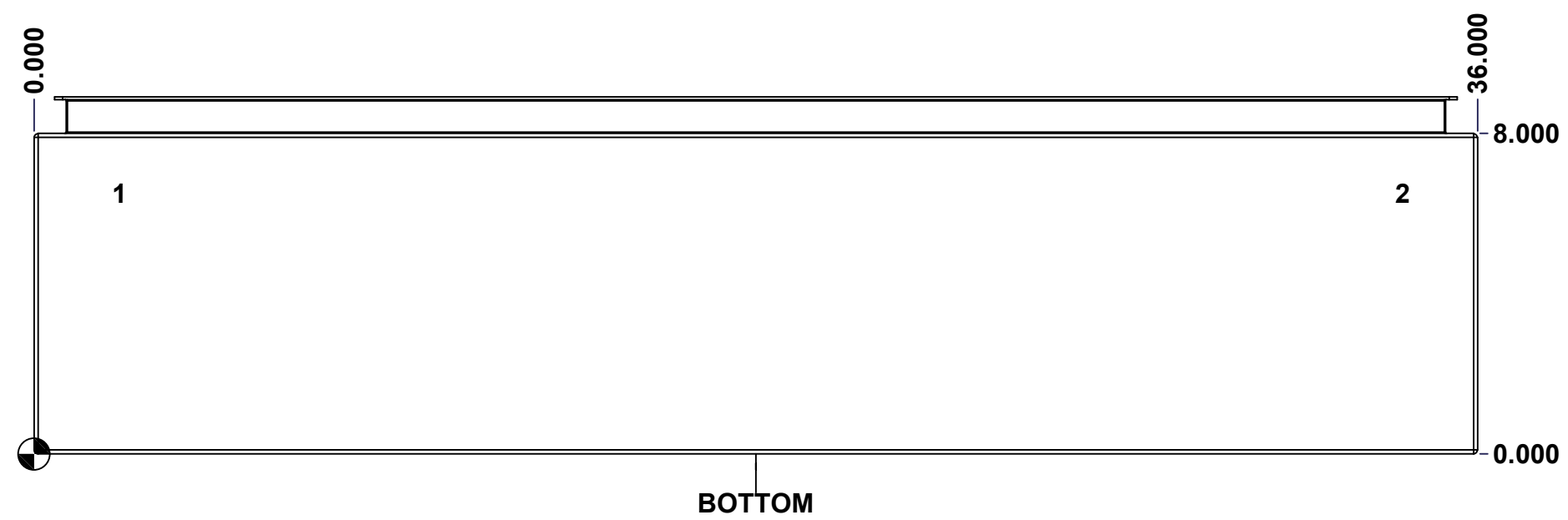

	Description	Status	
	5412ESSW 60" x 36" x 8" Body	(NULL)	
	Part Number Numéro Pièce	Rev.	5
	<b>5412ESSW603608THB</b>	<b>0</b>	15

This drawing is confidential and must not be reproduced or used without the consent of EXM

Ce dessin est confidentiel et ne doit pas être reproduit ou utilisé sans le consentement de EXM

**STANDARD FEATURES ARE NOT LISTED IN THIS HOLE TABLE**

**HOLE TABLE - BACK VIEW (CUSTOM FEATURE ONLY)**

CUT-OUT	XDIM	YDIM	DESCRIPTION
1	1.875	1.875	IP STUD M8 x 35mm (Inside)
2	1.875	58.125	IP STUD M8 x 35mm (Inside)
3	34.125	58.125	IP STUD M8 x 35mm (Inside)
4	34.125	1.875	IP STUD M8 x 35mm (Inside)
5	1.875	30.000	IP STUD M8 x 35mm (Inside)
6	34.125	30.000	IP STUD M8 x 35mm (Inside)
7	18.000	1.875	IP STUD M8 x 35mm (Inside)
8	18.000	58.125	IP STUD M8 x 35mm (Inside)
-----			
9	35.250	0.000	FOOT 885 ESMF4_OPEN
10	0.750	0.000	FOOT 885 ESMF4_OPEN
11	35.250	60.000	FOOT 885 ESMF4_CLOSE
12	0.750	60.000	FOOT 885 ESMF4_CLOSE

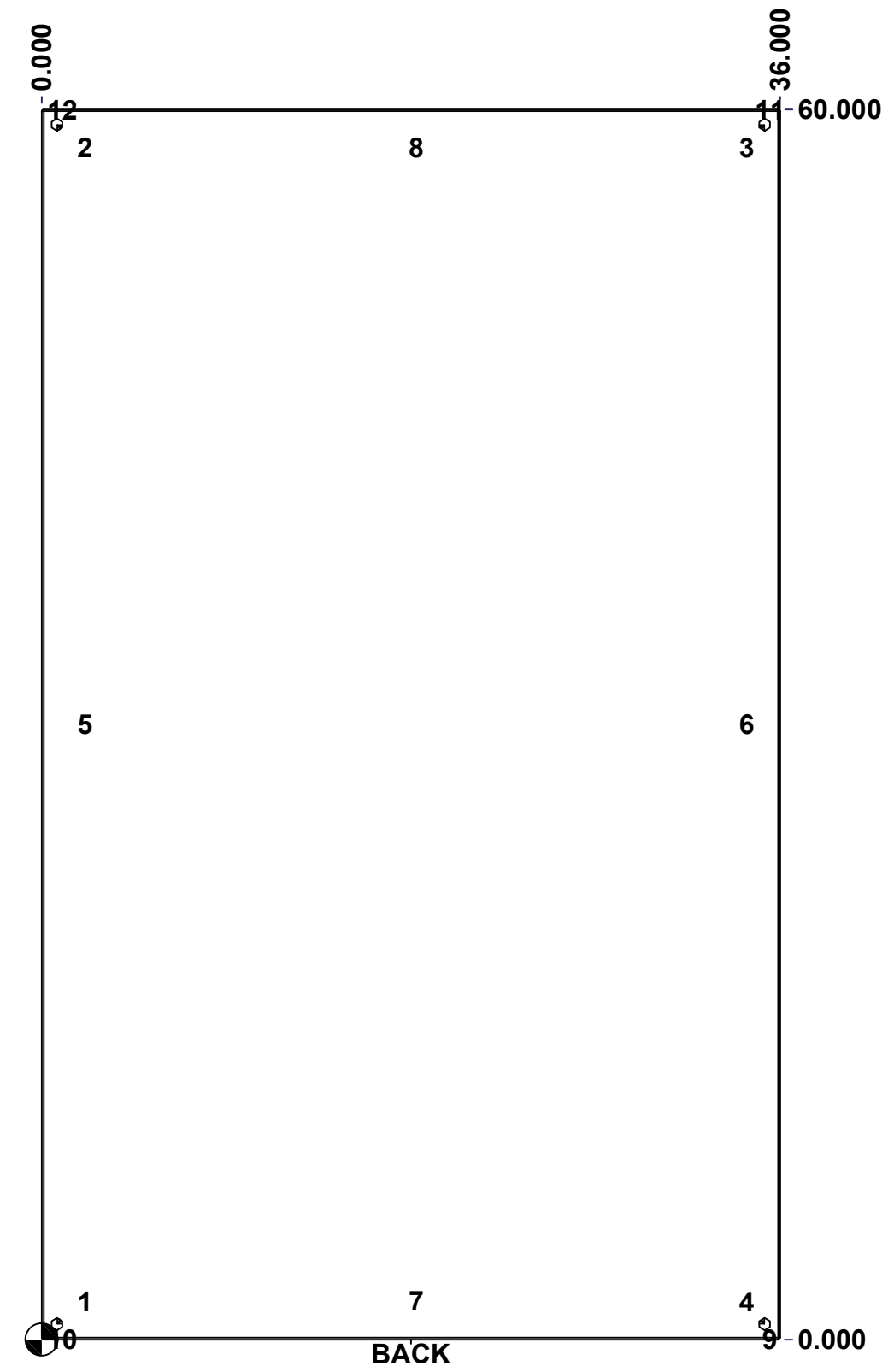

	Description	Status
	5412ESSW 60" x 36" x 8" Body	(NULL)
	Part Number Numéro Pièce	Rev.
	5412ESSW603608THB	6 0
		15

This drawing is confidential and must not be reproduced or used without the consent of EXM

Ce dessin est confidentiel et ne doit pas être reproduit ou utilisé sans le consentement de EXM

No.	Revisions	Date	By/Par

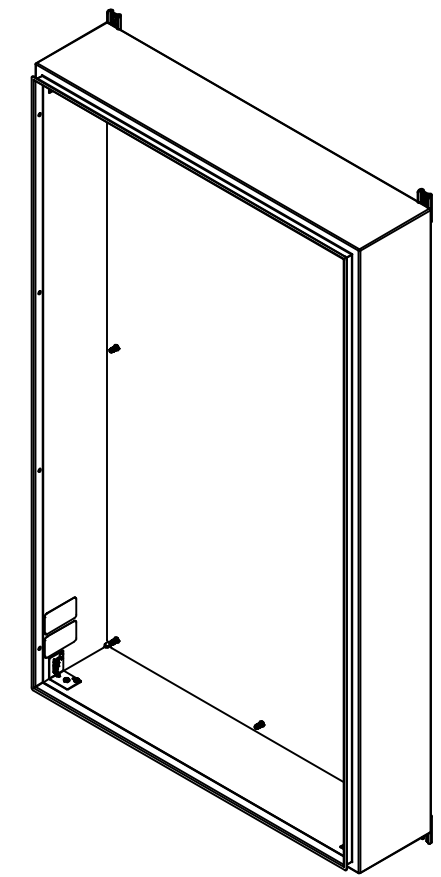

Isometric View



2	885ESMF4-FEET	0	885 ESMF4 Stainless Steel Mounting Foot
4	RIVET_NUT_SS_M10_FH_CE	0	Stainless Steel Rivet Nut M10 (Low Profile Close End)
4	STK-Q-06670	2	M10 x 16mm Stainless Steel Machine Screw
2	885ESMF4-FEET-A	0	885 ESMF4 Stainless Steel Mounting Foot (Opened Slot)
2	STK-S-00100	0	3.5" x 2" Silver Milar Flexcon Sticker
1	STK-K-70554	3	5412 ESTH Accessory Kit
1	5412ESSW603608THI-RS	0	5412ESSW 60" x 36" Right Insulation
1	5412ESSW603608THI-LS	0	5412ESSW 60" x 36" Left Insulation
1	5412ESSW603608THI-BT	0	5412ESSW 60" x 36" Top and Bottom Insulation
1	5412ESSW603608THI-TP	0	5412ESSW 60" x 36" Top and Bottom Insulation
1	5412ESSW603608THI-B	0	5412ESSW 60" x 36" Back Insulation
4	STK-Q-16070	1	Stud M6 x 18mm Stainless steel
8	STK-Q-16020	1	Stud M8 x 35mm Stainless Steel
1	5412ESSW603608THB-P	0	5412ESSW 60" x 36" x 8" Body Part

Qty	Part Number	Rev	Description
Parts List			

	Tél: (450) 979-4373 Fax: (450) 979-4626 <a href="http://www.exmweb.com">www.exmweb.com</a>	Flatness Aplatissement Max 3.0mm
	Projection 	Date 06-Jun-23
Customer Client	BoxCad: BoxCad	Date
Drawn By / Dessiné Par	BoxCad: BoxCad	Date
Material / Matière	14 Ga Stainless Steel 304 (1.7mm)	
Color / Couleur	Unpainted	Finish / Fini: Brushed
Description	5412ESSW 60" x 36" x 8" Body	
Part Number / Numéro Pièce	5412ESSW603608THB	Rev. 7 / 15

This drawing is confidential and must not be reproduced or used without the consent of EXM

Ce dessin est confidentiel et ne doit pas être reproduit ou utilisé sans le consentement de EXM

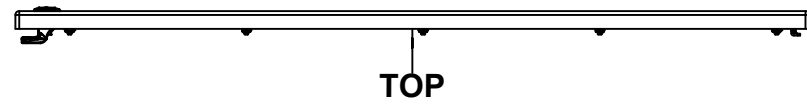

TOP

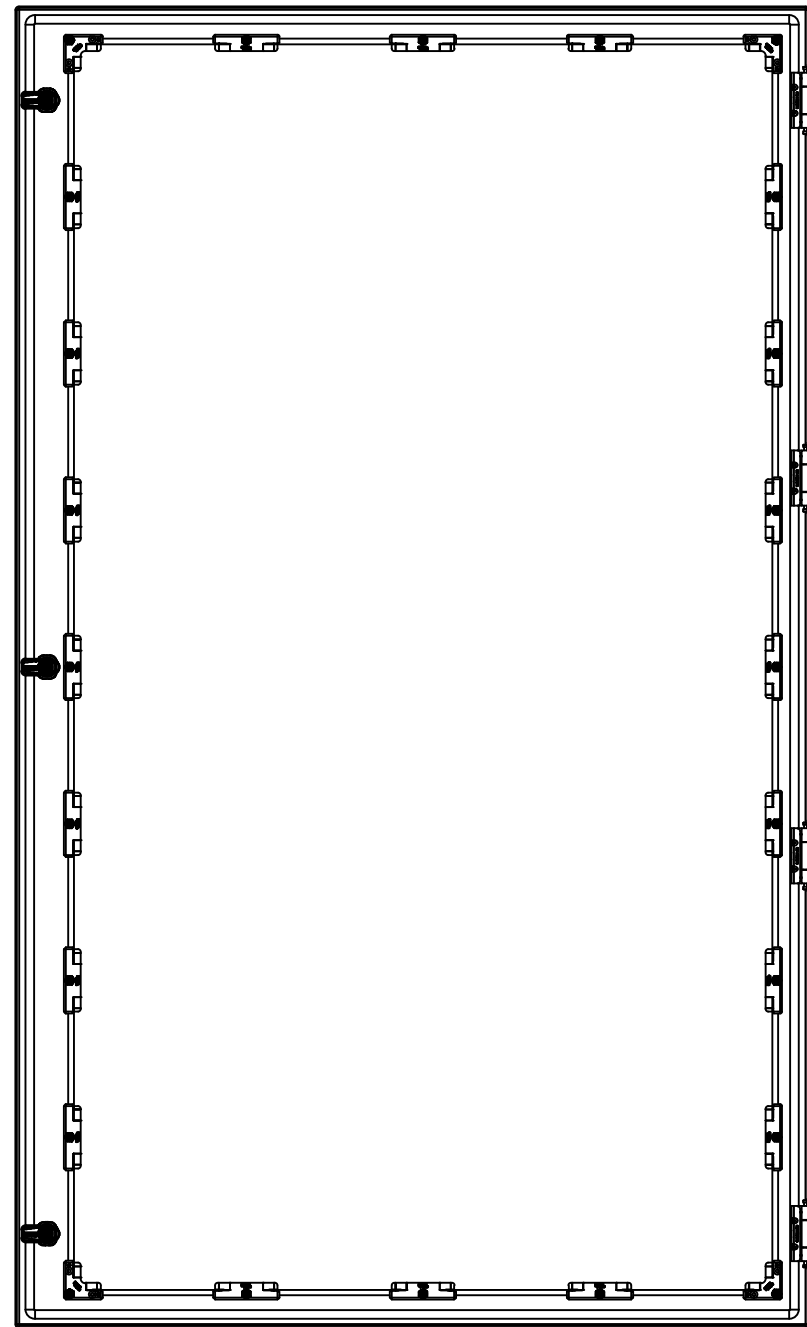

BACK



BOTTOM

0.000  
0.800

LEFT

0.000

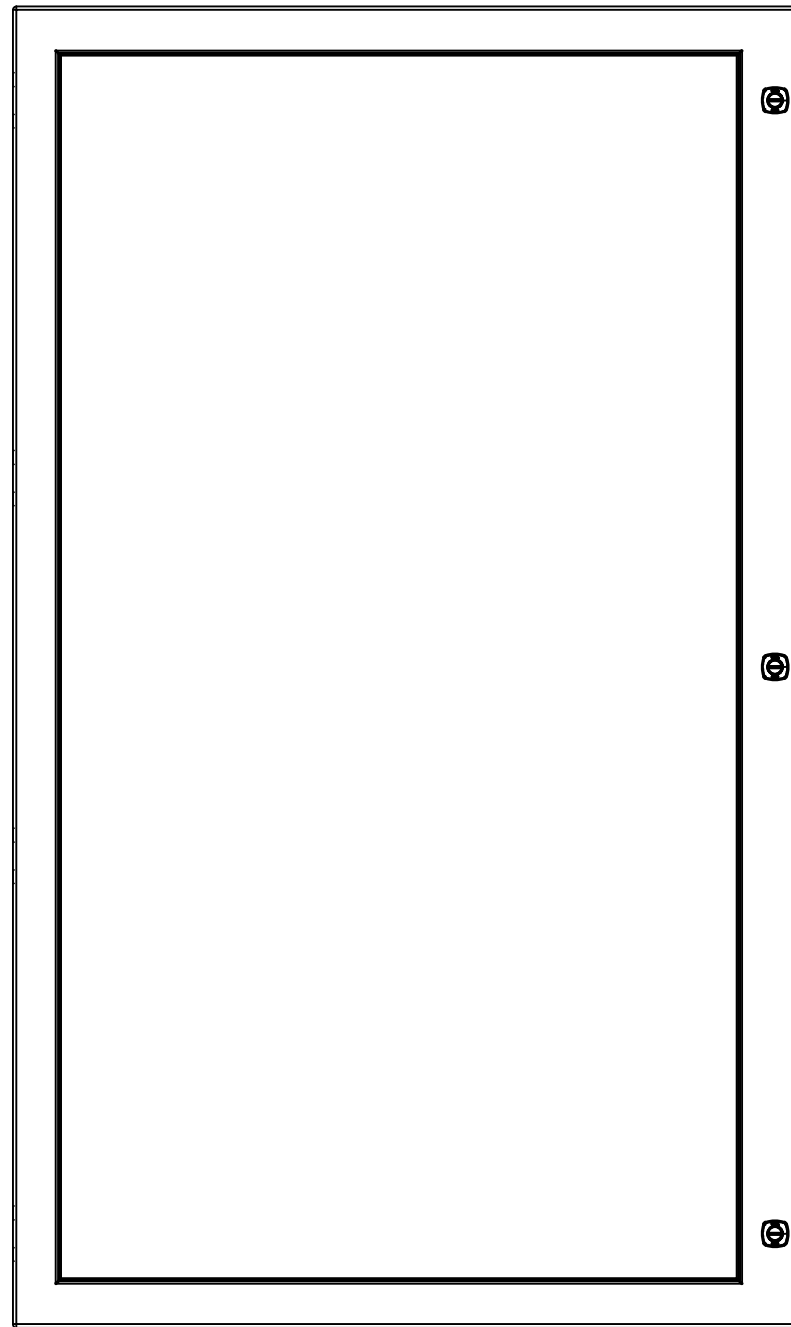

FRONT

35.918

59.803

RIGHT

0.000

No.	Revisions	Date	By/Par

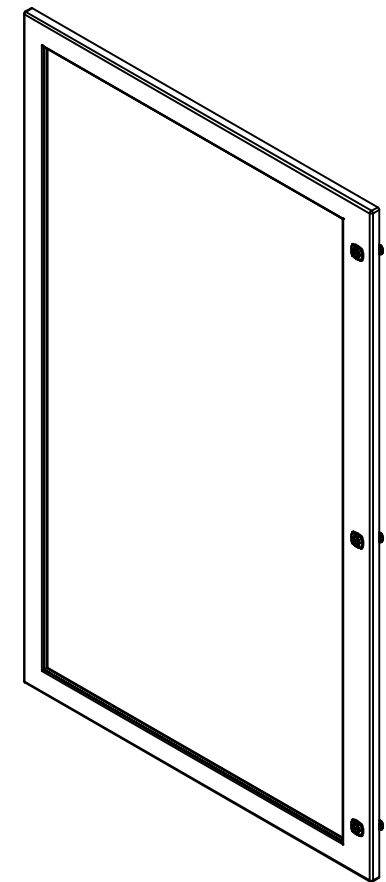

Isometric View



Tél: (450) 979-4373  
Fax: (450) 979-4626  
[www.exmweb.com](http://www.exmweb.com)

Flatness  
Aplatissement

Max 3.0mm

Projection

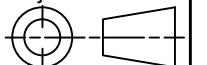

Customer Client	Date
Drawn By Dessiné Par	Date 06-Jun-23
Material Matière	14 Ga Stainless Steel 304 (1.7mm)
Color Couleur	Unpainted
Finish Fini	Brushed

Description	Detail Rev.
5412ESSW 60" x 36" Cover	

Part Number Numéro Pièce	Rev.	8
5412ESSW603608THC	0	15

SEE BILL OF MATERIAL ON LAST PAGE



This drawing is confidential and must not be reproduced or used without the consent of EXM

Ce dessin est confidentiel et ne doit pas être reproduit ou utilisé sans le consentement de EXM

**STANDARD FEATURES ARE NOT LISTED IN THIS HOLE TABLE**

**HOLE TABLE - FRONT VIEW (CUSTOM FEATURE ONLY)**

CUT-OUT	XDIM	YDIM	DESCRIPTION
1	1.469	8.621	STUD M6 x 18mm (Inside)
2	33.468	8.621	STUD M6 x 18mm (Inside)
3	1.469	15.714	STUD M6 x 18mm (Inside)
4	33.468	15.714	STUD M6 x 18mm (Inside)
5	1.469	22.808	STUD M6 x 18mm (Inside)
6	33.468	22.808	STUD M6 x 18mm (Inside)
7	1.469	29.902	STUD M6 x 18mm (Inside)
8	33.468	29.902	STUD M6 x 18mm (Inside)
9	1.469	36.995	STUD M6 x 18mm (Inside)
10	33.468	36.995	STUD M6 x 18mm (Inside)
11	1.469	44.089	STUD M6 x 18mm (Inside)
12	33.468	44.089	STUD M6 x 18mm (Inside)
13	1.469	51.182	STUD M6 x 18mm (Inside)
14	33.468	51.182	STUD M6 x 18mm (Inside)
15	1.469	58.276	STUD M6 x 18mm (Inside)
16	1.469	1.527	STUD M6 x 18mm (Inside)
17	9.469	58.276	STUD M6 x 18mm (Inside)
18	9.469	1.527	STUD M6 x 18mm (Inside)
19	17.469	58.276	STUD M6 x 18mm (Inside)
20	17.469	1.527	STUD M6 x 18mm (Inside)
21	25.468	58.276	STUD M6 x 18mm (Inside)
22	25.468	1.527	STUD M6 x 18mm (Inside)
23	33.468	58.276	STUD M6 x 18mm (Inside)
24	33.468	1.527	STUD M6 x 18mm (Inside)
-----			
25	34.494	55.553	880 SCQ4-SLSS6
26	34.494	29.902	880 SCQ4-SLSS6
27	34.494	4.250	880 SCQ4-SLSS6

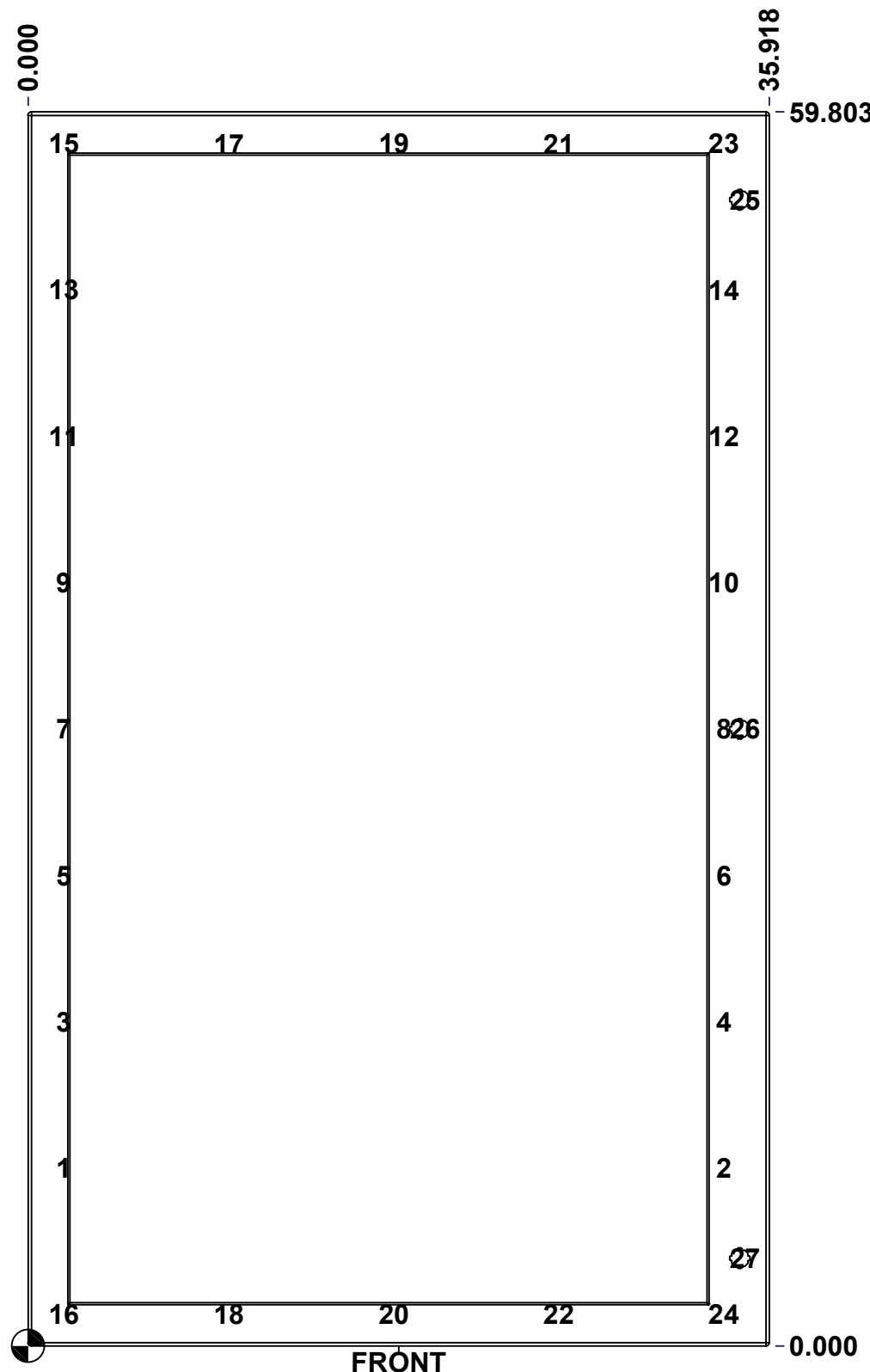

	Description		Status
	5412ESSW 60" x 36" Cover		(NULL)
Part Number		Rev.	9
<b>5412ESSW603608THC</b>		<b>0</b>	15

This drawing is confidential and must not be reproduced or used without the consent of EXM

Ce dessin est confidentiel et ne doit pas être reproduit ou utilisé sans le consentement de EXM

No.	Revisions	Date	By/Par

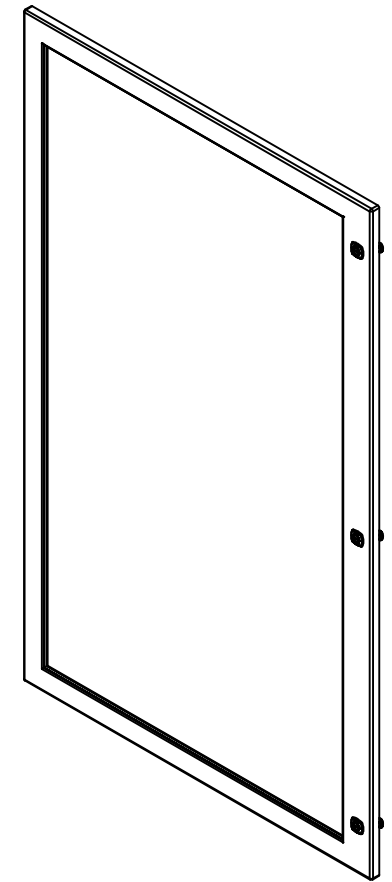

Isometric View



20	STK-Q-60701	2.1	880 WK - Lexan 1/4" Fixing Bracket
1	STK-A-60703	0	5412 ESW Lexan Bracket Kit
24	STK-Q-16053	1	Stud M6 x 23mm Stainless steel
1	STK-G-02710	0	880 HWKG - Windows Kit Gasket
1	5412ESSW603608THLXG	0	5412ESSW 60" x 36" Lexan Gasket Part
1	5412ESSW603608THLX	0	5412ESSW 56.375" x 32.125" Lexan Part
1	5412ESSW603608THG	0	5412ESSW 60" x 36" Cover Gasket Part
1	5412ESSW603608THC-P	0	5412ESSW 60" x 36" Cover Part
3	880 SCQ4-SLSS6	7	5412 ESS 1/4 Turn Lock
4	STK-A-33016	0	5412 ESS Bended Hinge (Body Part)
QTY	Part Number	Rev	Description
Parts List			

<p>Tél: (450) 979-4373 Fax: (450) 979-4626 <a href="http://www.exmweb.com">www.exmweb.com</a></p>	Flatness Aplatissement	Max 3.0mm
	Projection	
Customer Client	Date	
Drawn By Dessiné Par	BoxCad: BoxCad	Date 06-Jun-23
Material Matière	14 Ga Stainless Steel 304 (1.7mm)	
Color Couleur	Unpainted	Finish Fini Brushed
Description	Detail Rev.	
5412ESSW 60" x 36" Cover		
Part Number Numéro Pièce	Rev.	10
<b>5412ESSW603608THC</b>	<b>0</b>	15

This drawing is confidential and must not be reproduced or used without the consent of EXM

Ce dessin est confidentiel et ne doit pas être reproduit ou utilisé sans le consentement de EXM

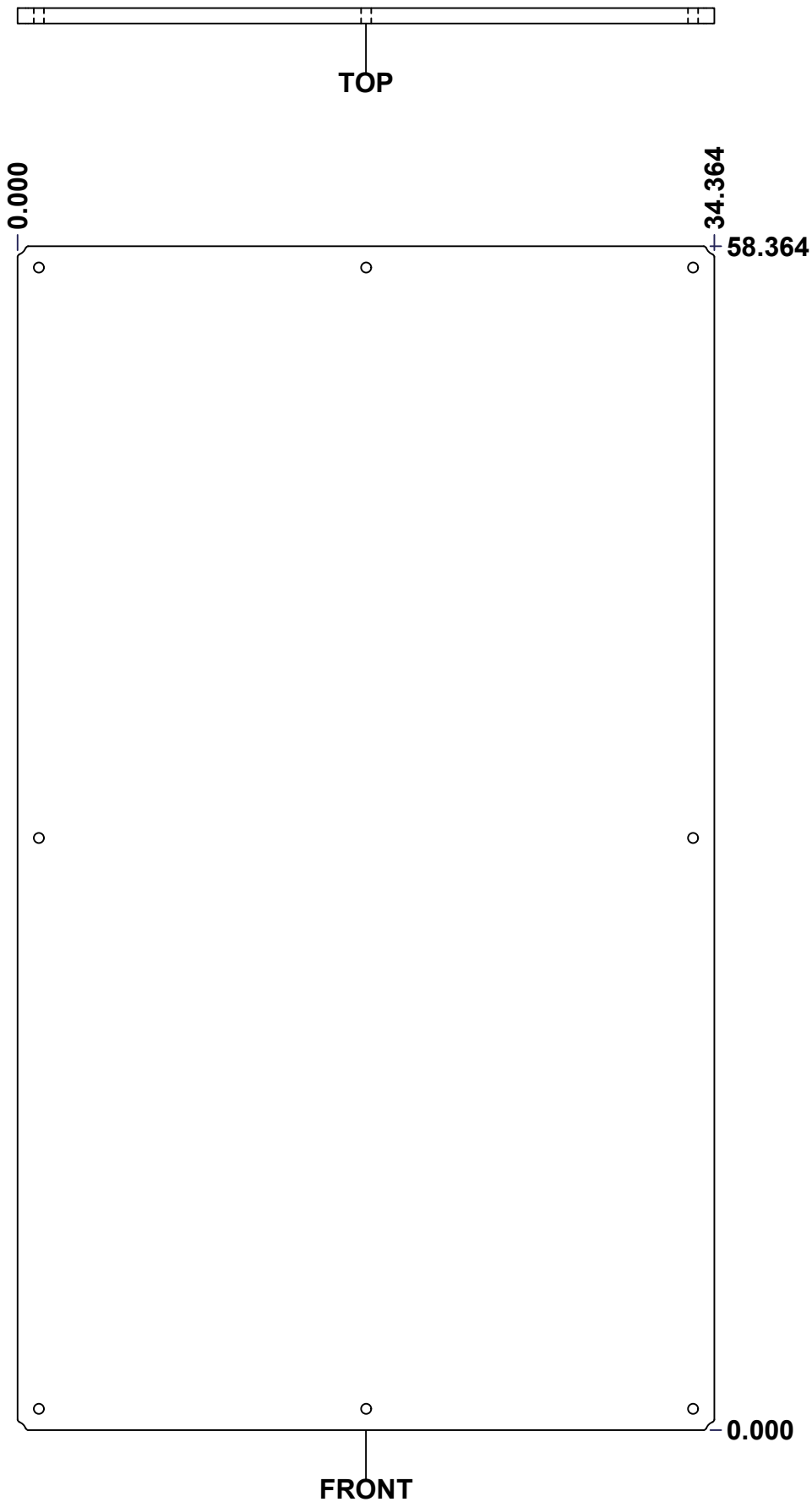

No.	Revisions	Date	By/Par

**Isometric View**

<p>Tél: (450) 979-4373                  Fax: (450) 979-4626  <a href="http://www.exmweb.com">www.exmweb.com</a></p>		Flatness Aplatissement
		Max 3.0mm
Projection		
Customer Client	Date	
Drawn By Dessiné Par	BoxCad: Patrick Deschenes	Date 23-Jan-07
Material Matière	Polyisocyanurate	
Color Couleur	Aluminum	Finish Fini N/A
Description	Detail Rev.	
5412ESSW 60" x 36" Back Insulation		
Part Number Numéro Pièce	Rev.	11
<b>5412ESSW603608TH-B</b>	<b>0</b>	15

**SEE BILL OF MATERIAL ON LAST PAGE**

This drawing is confidential and must not be reproduced or used without the consent of EXM

Ce dessin est confidentiel et ne doit pas être reproduit ou utilisé sans le consentement de EXM

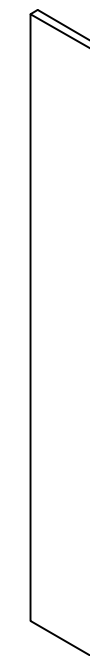
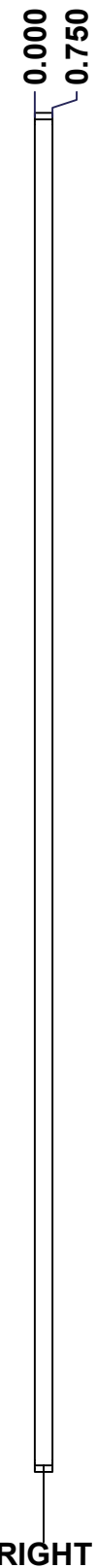
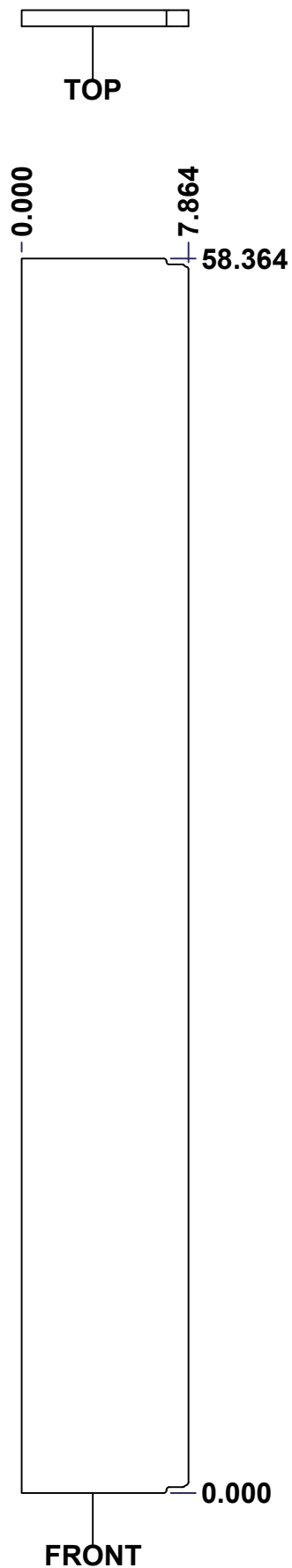

Isometric View



Tél: (450) 979-4373  
 Fax: (450) 979-4626  
[www.exmweb.com](http://www.exmweb.com)

Flatness  
Aplatissement

Max 3.0mm

Projection



Customer Client	Date
Drawn By Dessiné Par	Date
Material Matière	23-Jan-07
Polyisocyanurate	
Color Couleur	Finish Fini
Aluminum	N/A

Description	Detail Rev.
5412ESSW 60" x 36" Left Insulation	

Part Number Numéro Pièce	Rev.	12
5412ESSW603608THI-LS	0	15

SEE BILL OF MATERIAL ON LAST PAGE

This drawing is confidential and must not be reproduced or used without the consent of EXM

Ce dessin est confidentiel et ne doit pas être reproduit ou utilisé sans le consentement de EXM

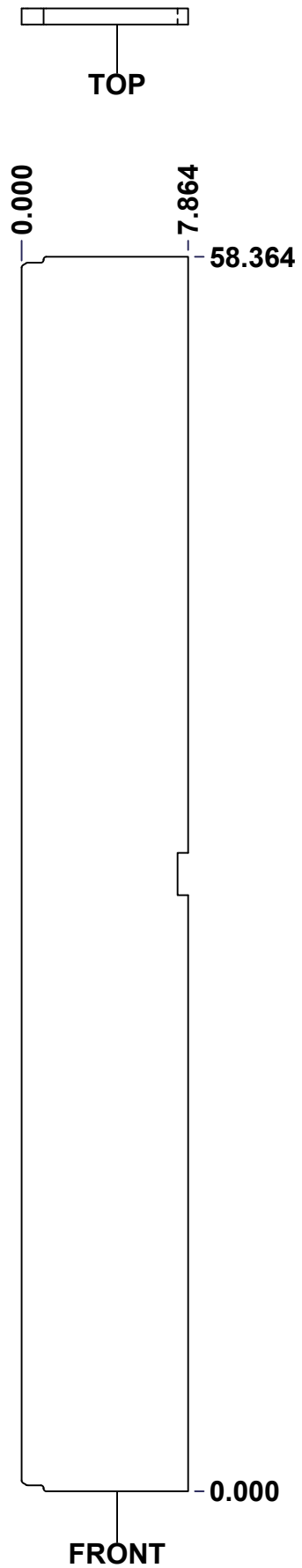

No.	Revisions	Date	By/Par

**Isometric View**

<p>Tél: (450) 979-4373 Fax: (450) 979-4626 <a href="http://www.exmweb.com">www.exmweb.com</a></p>		Flatness Aplatissement Max 3.0mm
Projection		
Customer Client	Date	
Drawn By Dessiné Par	BoxCad: Patrick Deschenes	Date 23-Jan-07
Material Matière	Polyisocyanurate	
Color Couleur	Aluminum	Finish Fini N/A
Description		Detail Rev.
5412ESSW 60" x 36" Right Insulation		
Part Number Numéro Pièce	Rev. 0	13 15

**SEE BILL OF MATERIAL ON LAST PAGE**

**5412ESSW603608THI-RS**

This drawing is confidential and must not be reproduced or used without the consent of EXM

Ce dessin est confidentiel et ne doit pas être reproduit ou utilisé sans le consentement de EXM

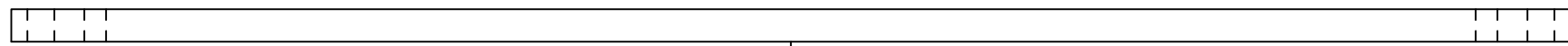

TOP

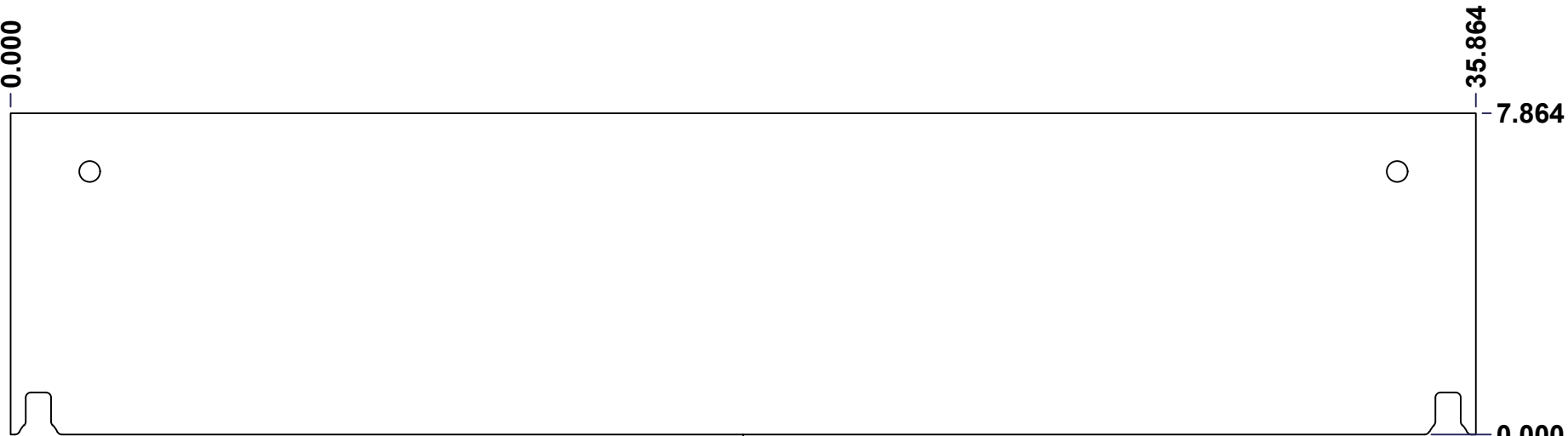

FRONT

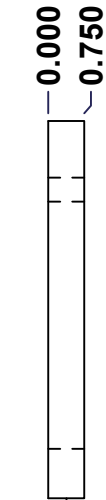

RIGHT

No.	Revisions	Date	By/Par

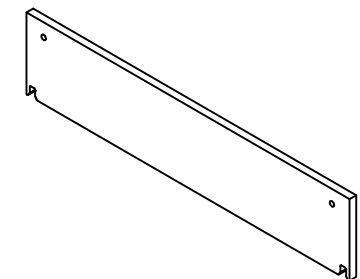

Isometric View



Tél: (450) 979-4373  
 Fax: (450) 979-4626  
[www.exmweb.com](http://www.exmweb.com)

Flatness  
Aplatissement

Max 3.0mm

Projection

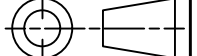

Customer Client	Date
Drawn By / Dessiné Par: BoxCad: Patrick Deschenes	Date: 23-Jan-07
Material / Matière: Polyisocyanurate	
Color / Couleur: Aluminum	Finish / Fini: N/A

Description: 5412ESSW 60" x 36" Top and Bottom Insulation	Detail Rev.
---	-------------

Part Number / Numéro Pièce: 5412ESSW603608THI-TP	Rev. 0	14	15
--	--------	----	----

SEE BILL OF MATERIAL ON LAST PAGE

This drawing is confidential and must not be reproduced or used without the consent of EXM

Ce dessin est confidentiel et ne doit pas être reproduit ou utilisé sans le consentement de EXM

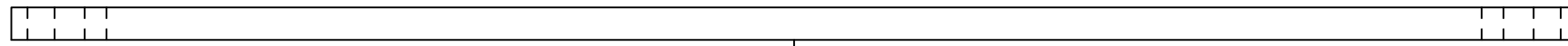

TOP

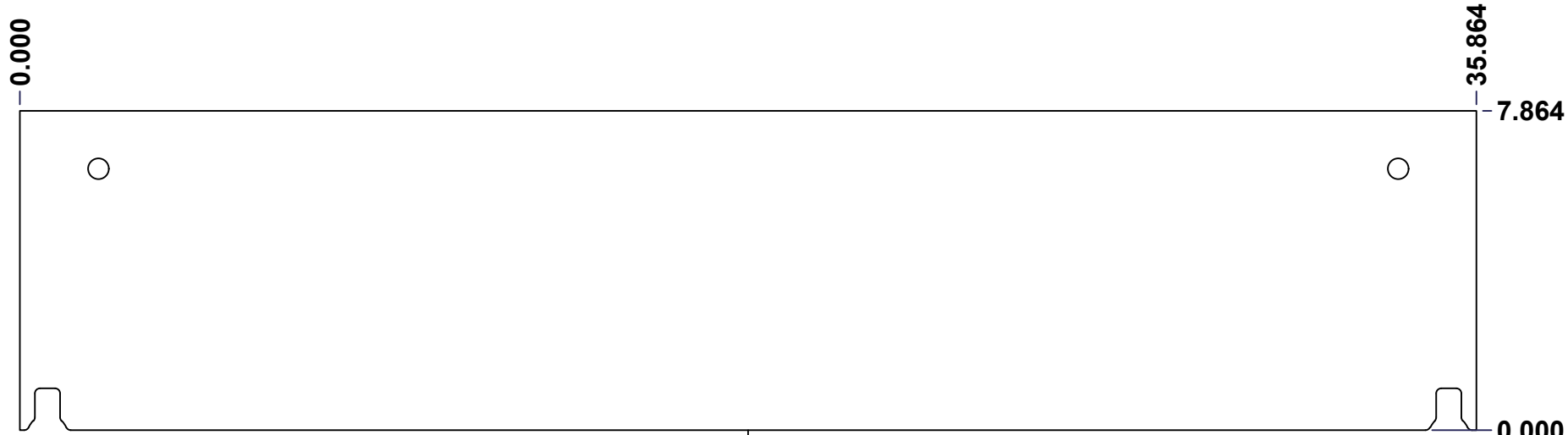

FRONT

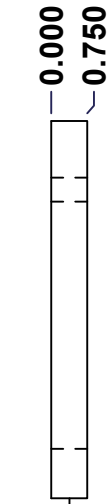

RIGHT

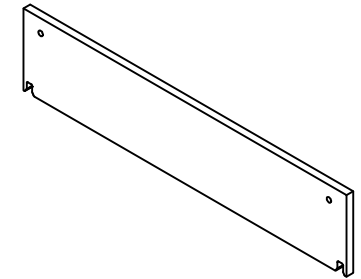

Isometric View

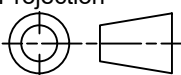

No.	Revisions	Date	By/Par

 Tél: (450) 979-4373 Fax: (450) 979-4626 <a href="http://www.exmweb.com">www.exmweb.com</a>		Flatness Aplatissement Max 3.0mm
Customer Client		Projection 
Drawn By / Dessiné Par: BoxCad: Patrick Deschenes		Date: 23-Jan-07
Material / Matière: Polyisocyanurate		
Color / Couleur: Aluminum	Finish / Fini: N/A	
Description: 5412ESSW 60" x 36" Top and Bottom Insulation		Detail Rev.
Part Number / Numéro Pièce: 5412ESSW603608THI-BT		Rev. 0 / 15

SEE BILL OF MATERIAL ON LAST PAGE

This drawing is confidential and must not be reproduced or used without the consent of EXM

Tolerance ±1/32" unless otherwise specified

C:\Vault Workspace\Inventor Dwg\Inv-8\881SP\881SP6036G.idw

Tolérance ±1/32" sauf spécification contraire

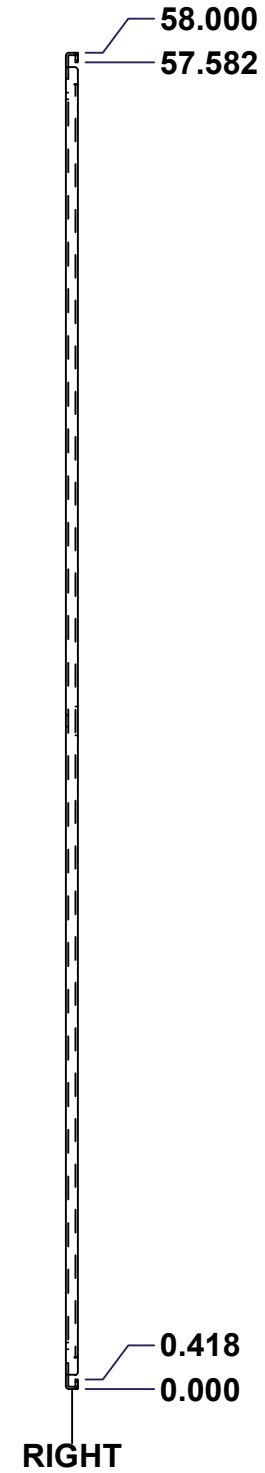
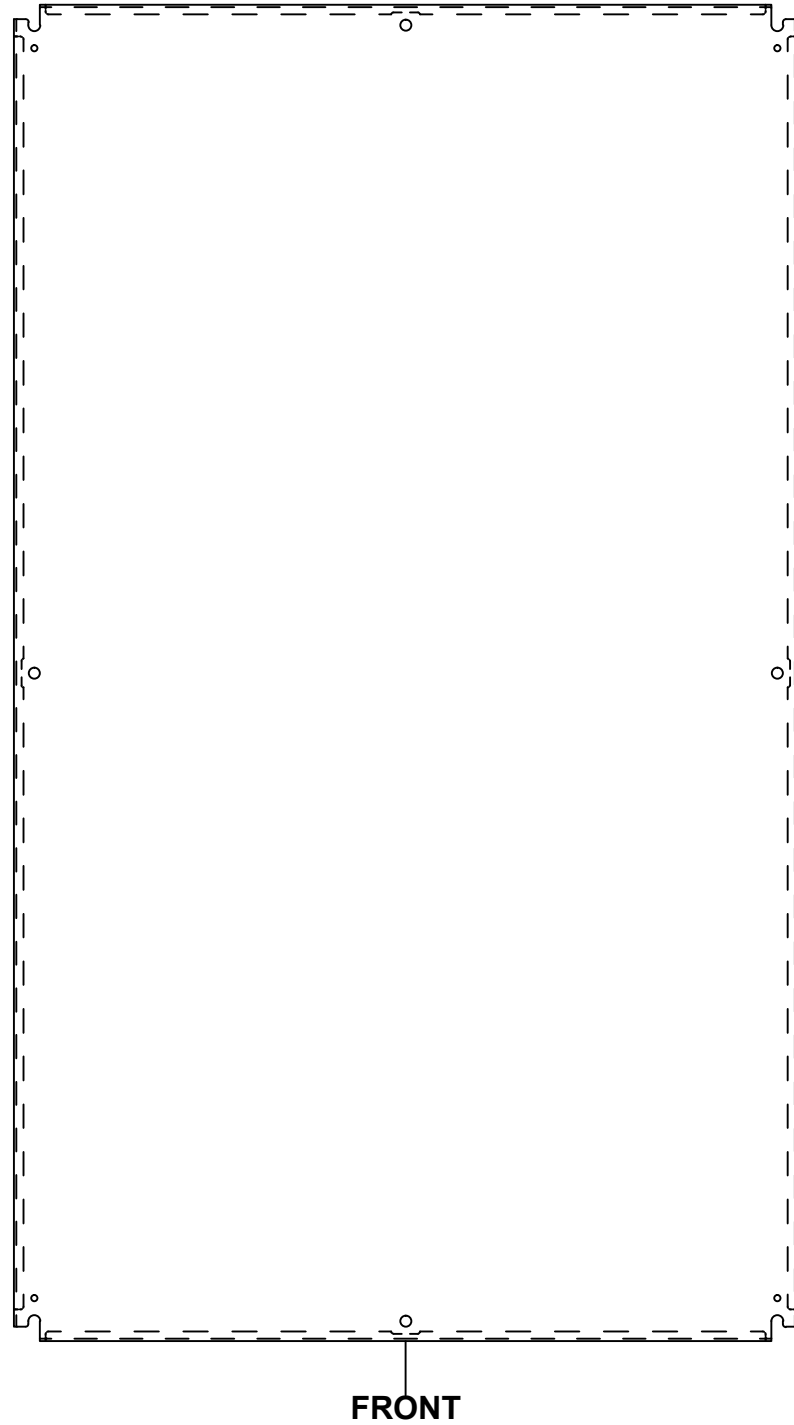
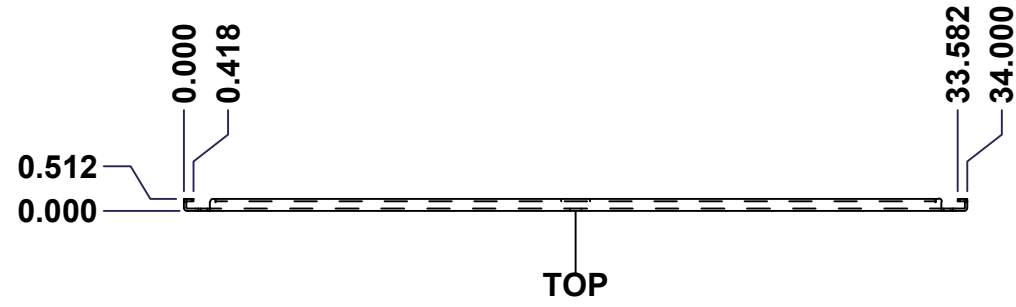

No.	Revisions	Date	By/Par

Isometric View

Tél: (450) 979-4373 Fax: (450) 979-4626 www.exmweb.com		Flatness Aplatissement Max 3.0mm Projection 
Customer Client	Date	
Drawn By Dessiné Par	BoxCad	Date 23-Jan-07
Material Matière	See Part List	
Color Couleur	See Part List	Finish Fini See Part List
Description		Detail Rev.
881 SP - Inner Panel		
Part Number Numéro Pièce	881 SP6036G	Rev. 1 0

Qty	Part Number	Rev	Description	Material	Color	Finish
1	881 SP6036G-P	0	881 SP - Inner Panel Part	12 Ga Galvanized	Unpainted	Galvanized

Parts List

Ce dessin est confidentiel et ne doit pas être reproduit ou utilisé sans le consentement de EXM



This drawing is confidential and must not be reproduced or used without the consent of EXM

Ce dessin est confidentiel et ne doit pas être reproduit ou utilisé sans le consentement de EXM

Table 1			FRONT VIEW
CUT-OUT	XDIM	YDIM	DESCRIPTION
1	17.000	0.875	MTG STUD HOLE (RND Ø0.500)
2	0.875	29.000	MTG STUD HOLE (RND Ø0.500)
3	33.125	29.000	MTG STUD HOLE (RND Ø0.500)
4	17.000	57.125	MTG STUD HOLE (RND Ø0.500)
5	0.875	1.875	GROUND HOLE (RND Ø0.290)
6	33.125	1.875	GROUND HOLE (RND Ø0.290)
7	0.875	56.125	GROUND HOLE (RND Ø0.290)
8	33.125	56.125	GROUND HOLE (RND Ø0.290)

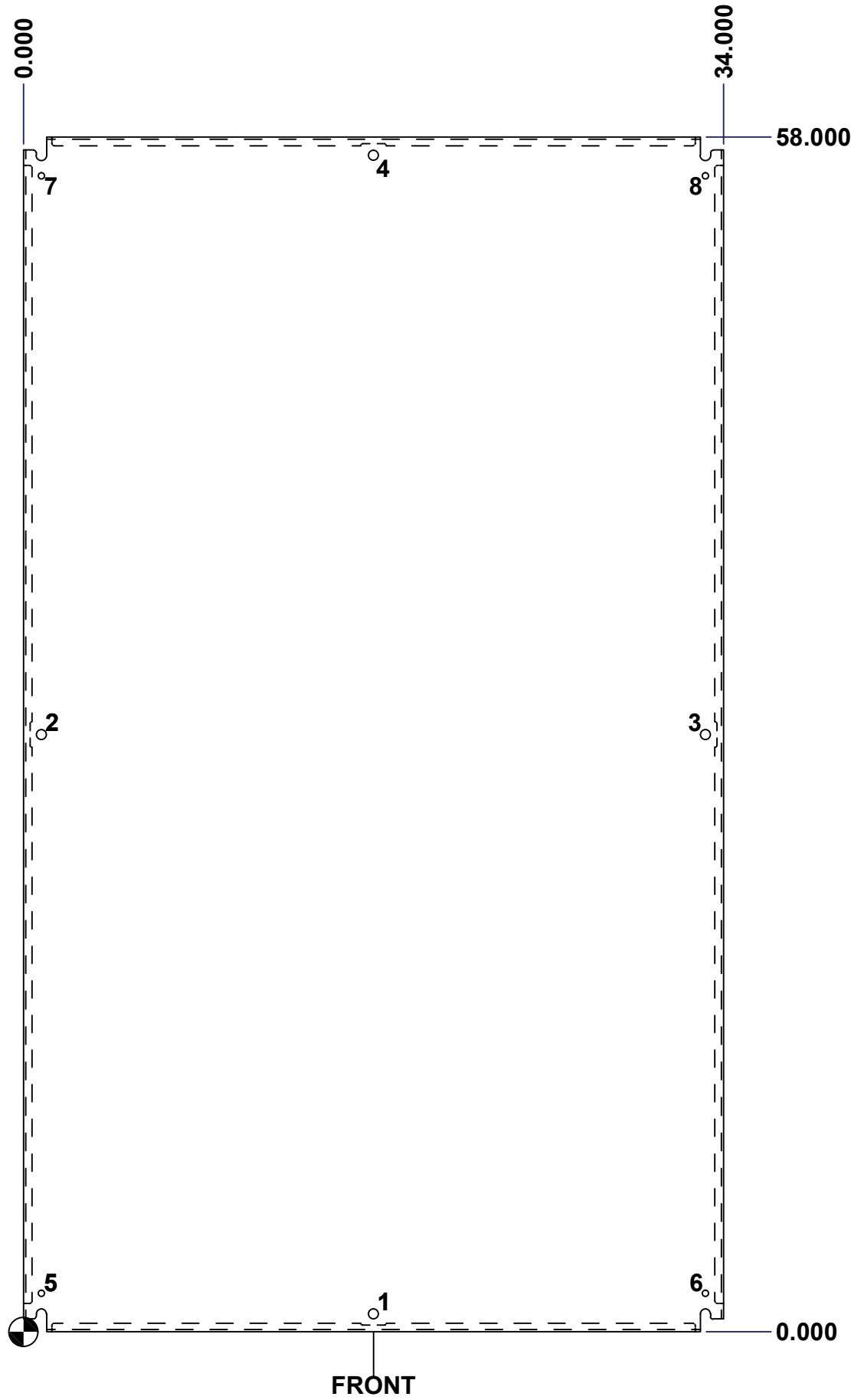

All knockouts are actual size / Les disques défonçables sont grandeur réel

No.	Revisions	Date	By/Par

Isometric View

		Tél: (450) 979-4373 Fax: (450) 979-4626 www.exmweb.com		Flatness Aplatissement Max 3.0mm	
Customer Client		Date		Projection 	
Drawn By Dessiné Par		BoxCad		Date 23-Jan-07	
Material Matière		See Part List			
Color Couleur		See Part List		Finish Fini	
Description 881 SP - Inner Panel				Detail Rev.	
Part Number Numéro Pièce <b>881 SP6036G</b>				Rev. 2 <b>0</b>	