

This drawing is confidential and must not be reproduced or used without the consent of EXM

Ce dessin est confidentiel et ne doit pas être reproduit ou utilisé sans le consentement de EXM

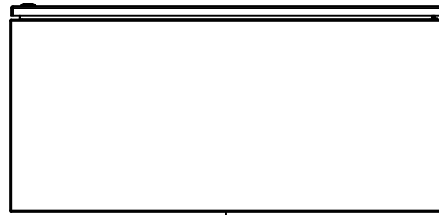

TOP

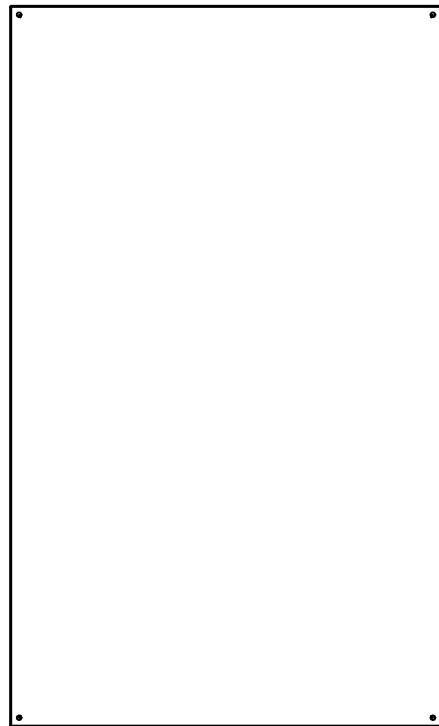

BACK

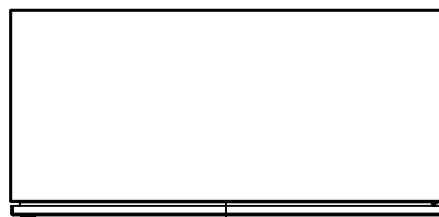

BOTTOM

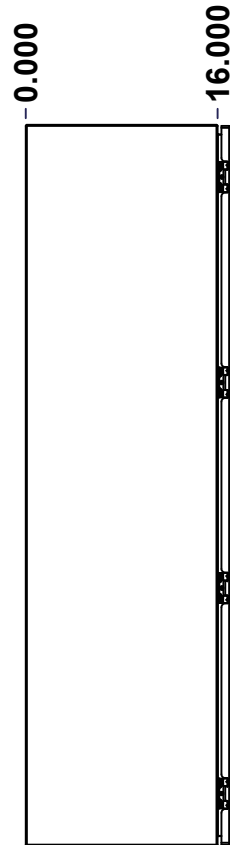

LEFT

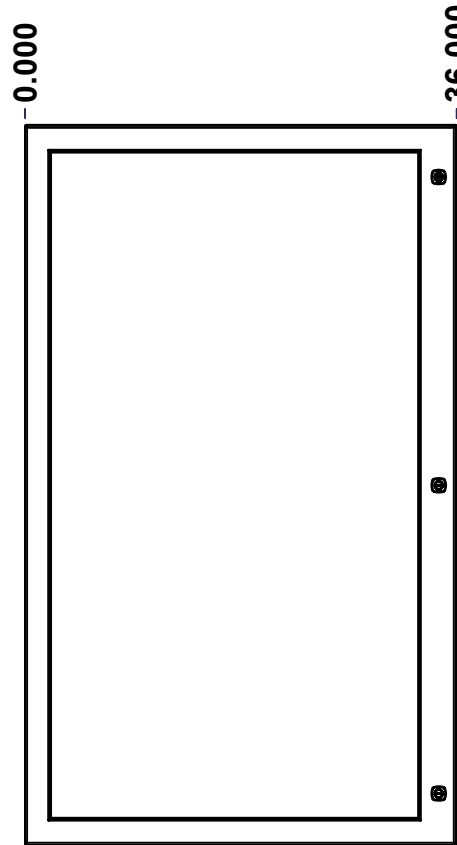

FRONT

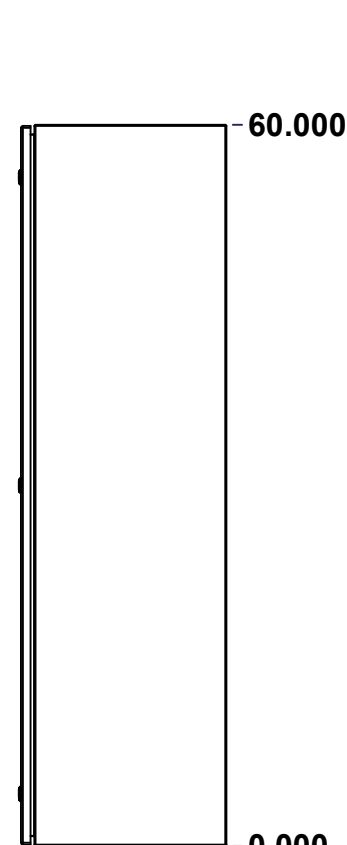

RIGHT

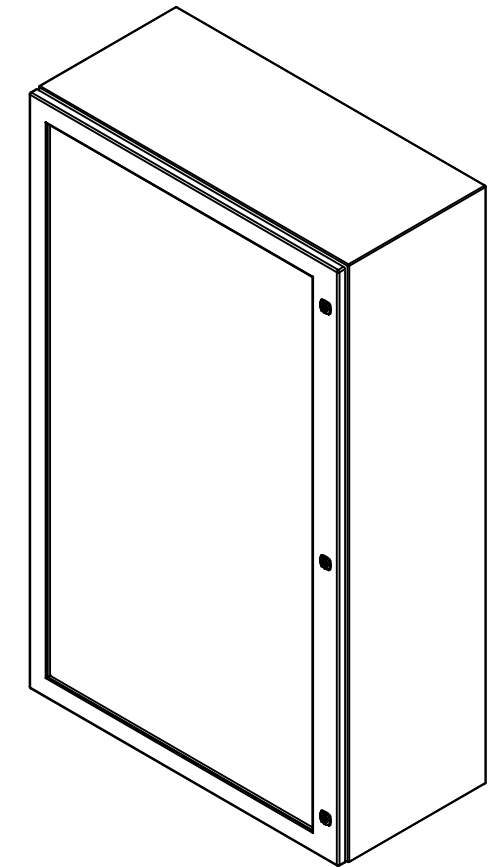

Isometric View



**GRAIN DIRECTION:
TOP/BOTTOM: HORIZONTAL
LEFT/RIGHT/BACK/FRONT: VERTICAL**

SEE BILL OF MATERIAL ON LAST PAGE

No.	Revisions	Date	By/Par

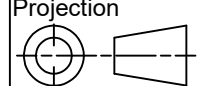
 Tél: (450) 979-4373 Fax: (450) 979-4626 www.exmweb.com		Flatness Aplatissement Max 3.0mm Projection 
Customer Client	Date	
Drawn By Dessiné Par	BoxCad: BoxCad	Date 01-May-13
Material Matière	14 Ga Stainless Steel 304 (1.7mm)	
Color Couleur	Unpainted	Finish Fini Brushed
Description	Detail Rev.	
5412ESSW 60" x 36" x 16" Assembly		
Part Number Numéro Pièce	Rev.	1
5412ESSW603616	0	2

This drawing is confidential and must not be reproduced or used without the consent of EXM

Ce dessin est confidentiel et ne doit pas être reproduit ou utilisé sans le consentement de EXM

NOTE	
ITEM	DESCRIPTION
1	NEMA 4X Enclosure
2	C/W Standard ground studs on box and cover
3	W/O Standard door stiffener
4	C/W Standard inner panel (Included)
5	C/W Standard inner panel mounting studs

No.	Revisions	Date	By/Par

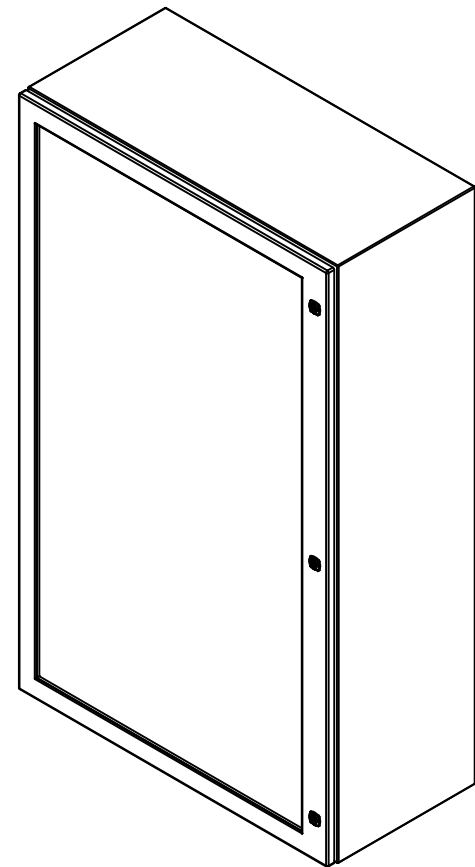

Isometric View



Tél: (450) 979-4373
 Fax: (450) 979-4626
www.exmweb.com

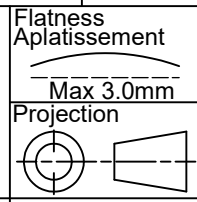

PACKING		
ITEM	QTY	DESCRIPTION
Cardboard sleeve	2	Top and Bottom
Cardboard strip	2	Between back of enclosure and inner panel
Plastic bag	1	To protect cover surface and inside gasket
Cardboard corner	4	To reinforced for the plastic strap tightening
Plastic strap - Black	2	To Squeeze the 2 cardboard sleeve together
Packaging label	3	White label with PN
Plastic strap- Green	2	To secure the enclosure to the wood pallet
Wood Pallet	1	2" deeper and 3" larger than enclosure size

1	880 PP	6	Self Adhesive Print Pocket
1	STK-K-01800	5	5412 ES Accessory Kit
1	881 SP6036G	0	881 SP - Inner Panel
1	5412ESSW603616C	0	5412ESSW 60" x 36" Cover
8	STK-Q-07310	2	Flange Lock Nut M8
8	STK-Q-07610	8	M8 Plastic Spacer 22.2mm
1	5412ESSW603616B	0	5412ESSW 60" x 36" x 16" Body
4	STK-Q-04051-07	8	M6 x 7mm Stainless Steel Hexagon Socket Head Machine Screw with Nyseal
Qty	Part Number	Rev	Description
Parts List			

Customer Client	Date
Drawn By Dessiné Par	BoxCad: BoxCad
Date	01-May-13
Material Matière	14 Ga Stainless Steel 304 (1.7mm)
Color Couleur	Unpainted
Finish Fini	Brushed
Description	5412ESSW 60" x 36" x 16" Assembly
Part Number Numéro Pièce	5412ESSW603616
Rev.	2
	0
	2

This drawing is confidential and must not be reproduced or used without the consent of EXM

Ce dessin est confidentiel et ne doit pas être reproduit ou utilisé sans le consentement de EXM

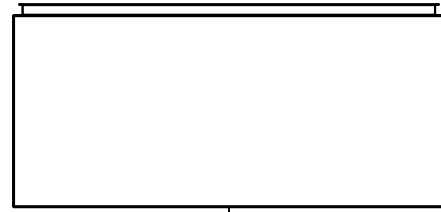

TOP

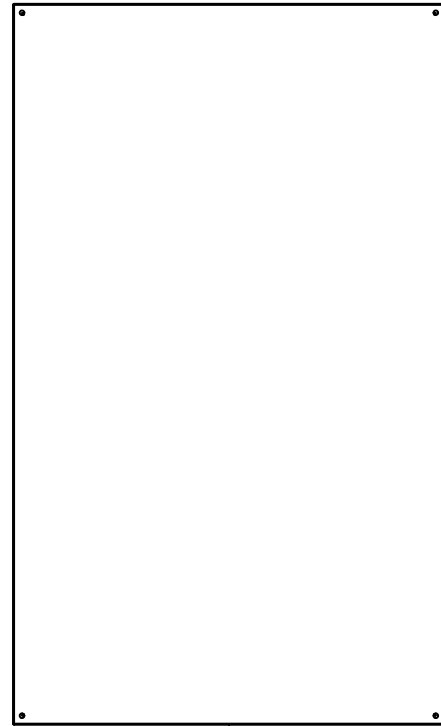

BACK

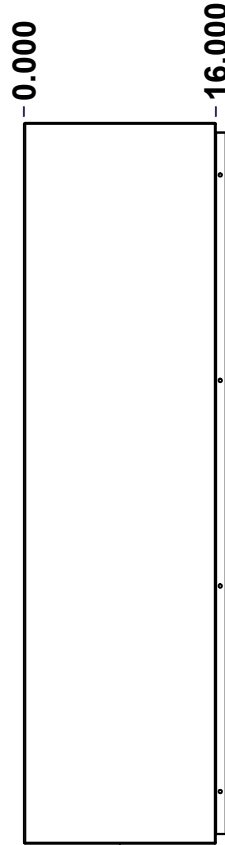

LEFT

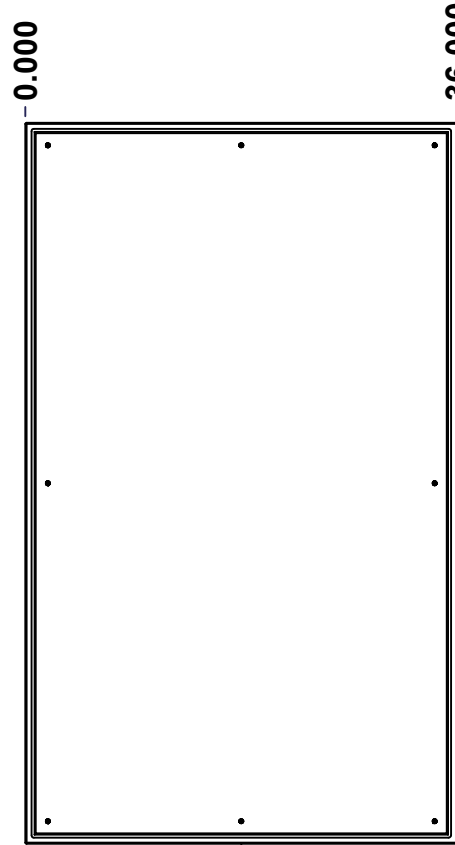

FRONT

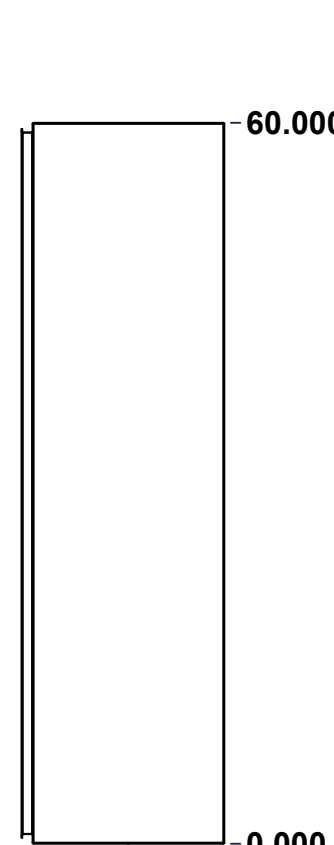

RIGHT

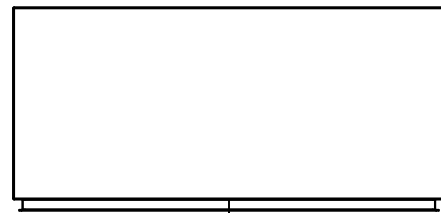

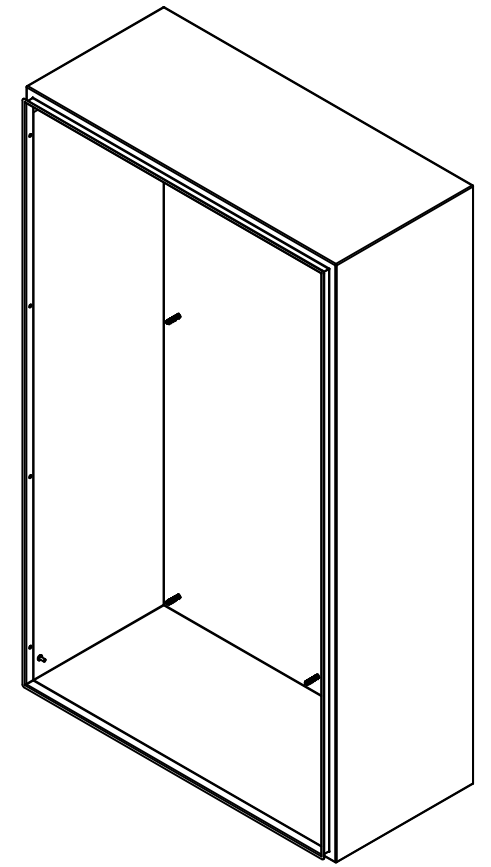

BOTTOM

No.	Revisions	Date	By/Par



Isometric View

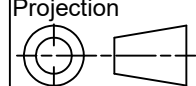

 Tél: (450) 979-4373 Fax: (450) 979-4626 www.exmweb.com		Flatness Aplatissement  Max 3.0mm Projection 
Customer Client	Date	
Drawn By Dessiné Par	BoxCad: BoxCad	Date 01-May-13
Material Matière	14 Ga Stainless Steel 304 (1.7mm)	
Color Couleur	Unpainted	Finish Fini Brushed
Description	Detail Rev.	
5412ESSW 60" x 36" x 16" Body		
Part Number Numéro Pièce	Rev.	1 7
5412ESSW603616B	0	

SEE BILL OF MATERIAL ON LAST PAGE

This drawing is confidential and must not be reproduced or used without the consent of EXM

Ce dessin est confidentiel et ne doit pas être reproduit ou utilisé sans le consentement de EXM

STANDARD FEATURES ARE NOT LISTED IN THIS HOLE TABLE			
HOLE TABLE - LEFT VIEW (CUSTOM FEATURE ONLY)			
CUT-OUT	XDIM	YDIM	DESCRIPTION
1	14.500	2.000	GND STUD M6 x 16mm (Inside)
2	14.000	58.000	LABEL_EXM (Inside)

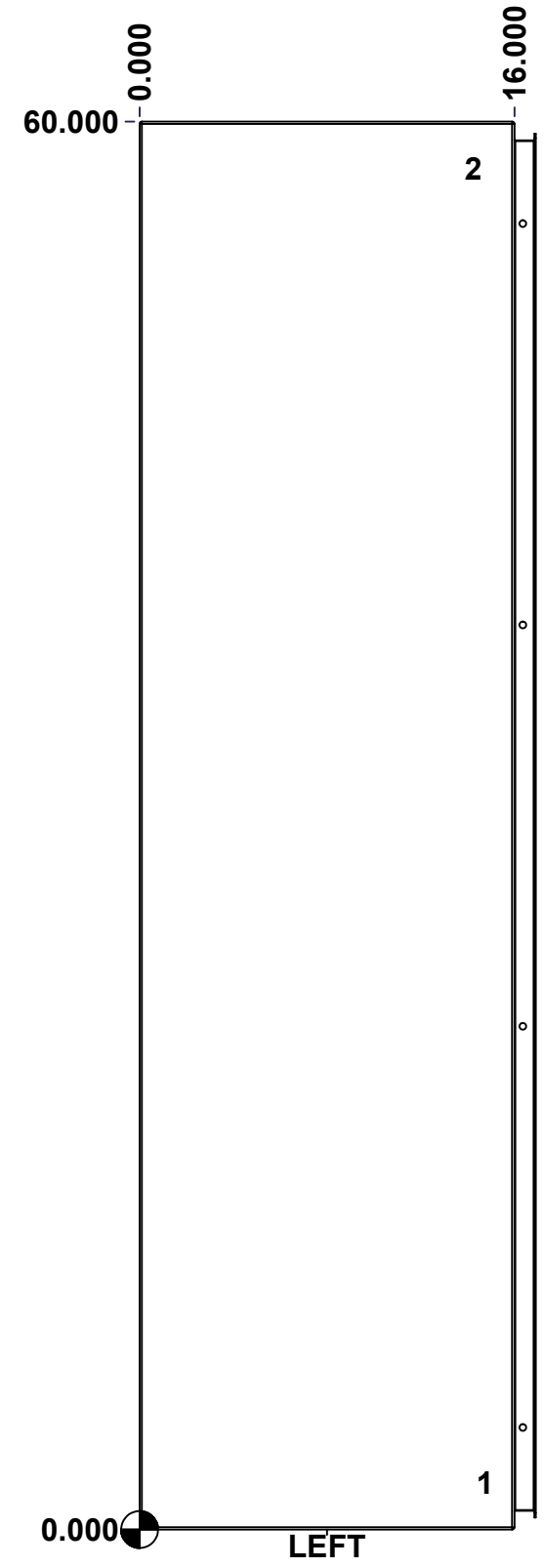

	Description	Status	
	5412ESSW 60" x 36" x 16" Body		
	Part Number Numéro Pièce	Rev.	
	5412ESSW603616B	0	5/7

This drawing is confidential and must not be reproduced or used without the consent of EXM

Ce dessin est confidentiel et ne doit pas être reproduit ou utilisé sans le consentement de EXM

STANDARD FEATURES ARE NOT LISTED IN THIS HOLE TABLE

HOLE TABLE - BACK VIEW (CUSTOM FEATURE ONLY)

CUT-OUT	XDIM	YDIM	DESCRIPTION
1	1.875	1.875	IP STUD M8 x 35mm (Inside)
2	1.875	58.125	IP STUD M8 x 35mm (Inside)
3	34.125	58.125	IP STUD M8 x 35mm (Inside)
4	34.125	1.875	IP STUD M8 x 35mm (Inside)
5	1.875	30.000	IP STUD M8 x 35mm (Inside)
6	34.125	30.000	IP STUD M8 x 35mm (Inside)
7	18.000	1.875	IP STUD M8 x 35mm (Inside)
8	18.000	58.125	IP STUD M8 x 35mm (Inside)

9	35.250	0.750	RND Ø0.390
10	35.250	59.250	RND Ø0.390
11	0.750	59.250	RND Ø0.390
12	0.750	0.750	RND Ø0.390

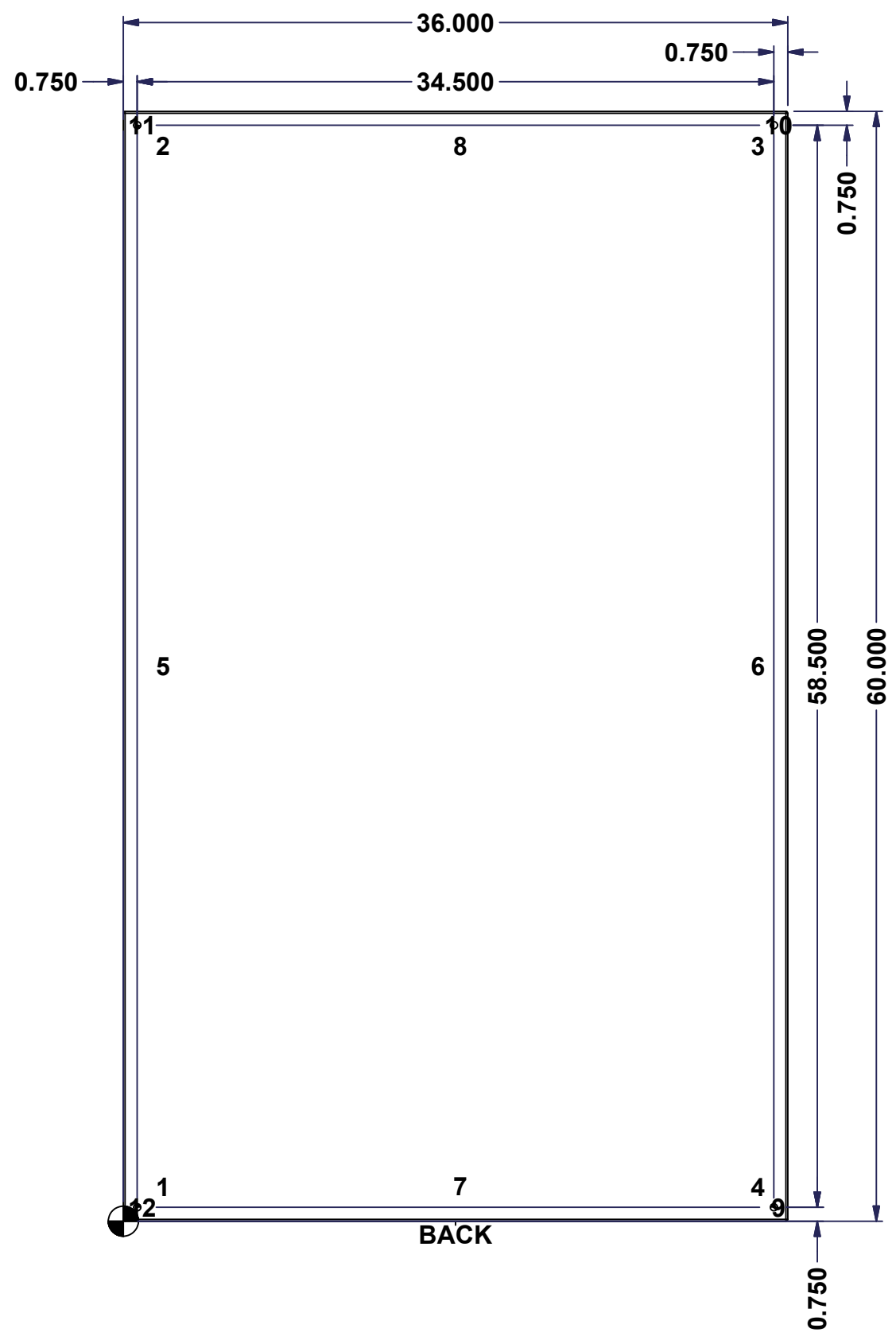



	Description		Status	
	5412ESSW 60" x 36" x 16" Body			
	Part Number Numéro Pièce		Rev.	6
	5412ESSW603616B		0	7

This drawing is confidential and must not be reproduced or used without the consent of EXM

Ce dessin est confidentiel et ne doit pas être reproduit ou utilisé sans le consentement de EXM

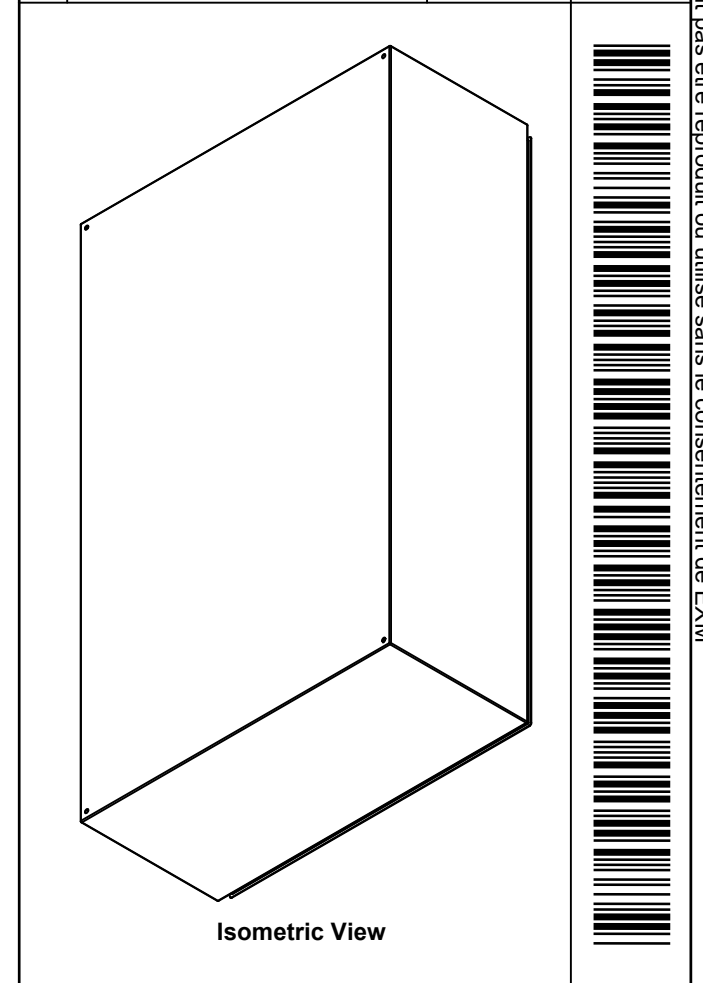
No.	Revisions	Date	By/Par

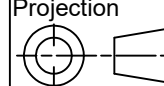

 Tél: (450) 979-4373 Fax: (450) 979-4626 www.exmweb.com		Flatness Aplatissement  Max 3.0mm Projection 
Customer Client	Date	
Drawn By Dessiné Par	BoxCad: BoxCad	Date 01-May-13
Material Matière	14 Ga Stainless Steel 304 (1.7mm)	
Color Couleur	Unpainted	Finish Fini Brushed
Description		Detail Rev.
5412ESSW 60" x 36" x 16" Body		
Part Number Numéro Pièce	Rev.	7
5412ESSW603616B	0	7

Qty	Part Number	Rev	Description
1	STK-S-00100	0	3.5" x 2" Silver Milar Flexcon Sticker
1	STK-Q-16085	0	Ground Stud M6 x 16mm Stainless Steel
8	STK-Q-16020	1	Stud M8 x 35mm Stainless Steel
1	5412ESSW603616B-P	0	5412ESSW 60" x 36" x 16" Body Part
Parts List			

This drawing is confidential and must not be reproduced or used without the consent of EXM

Ce dessin est confidentiel et ne doit pas être reproduit ou utilisé sans le consentement de EXM

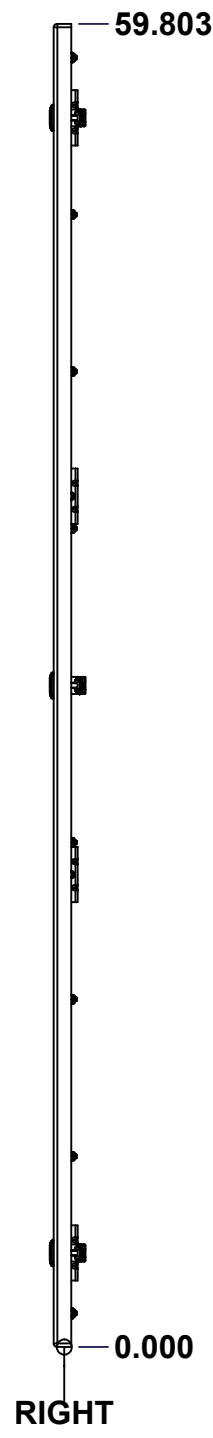
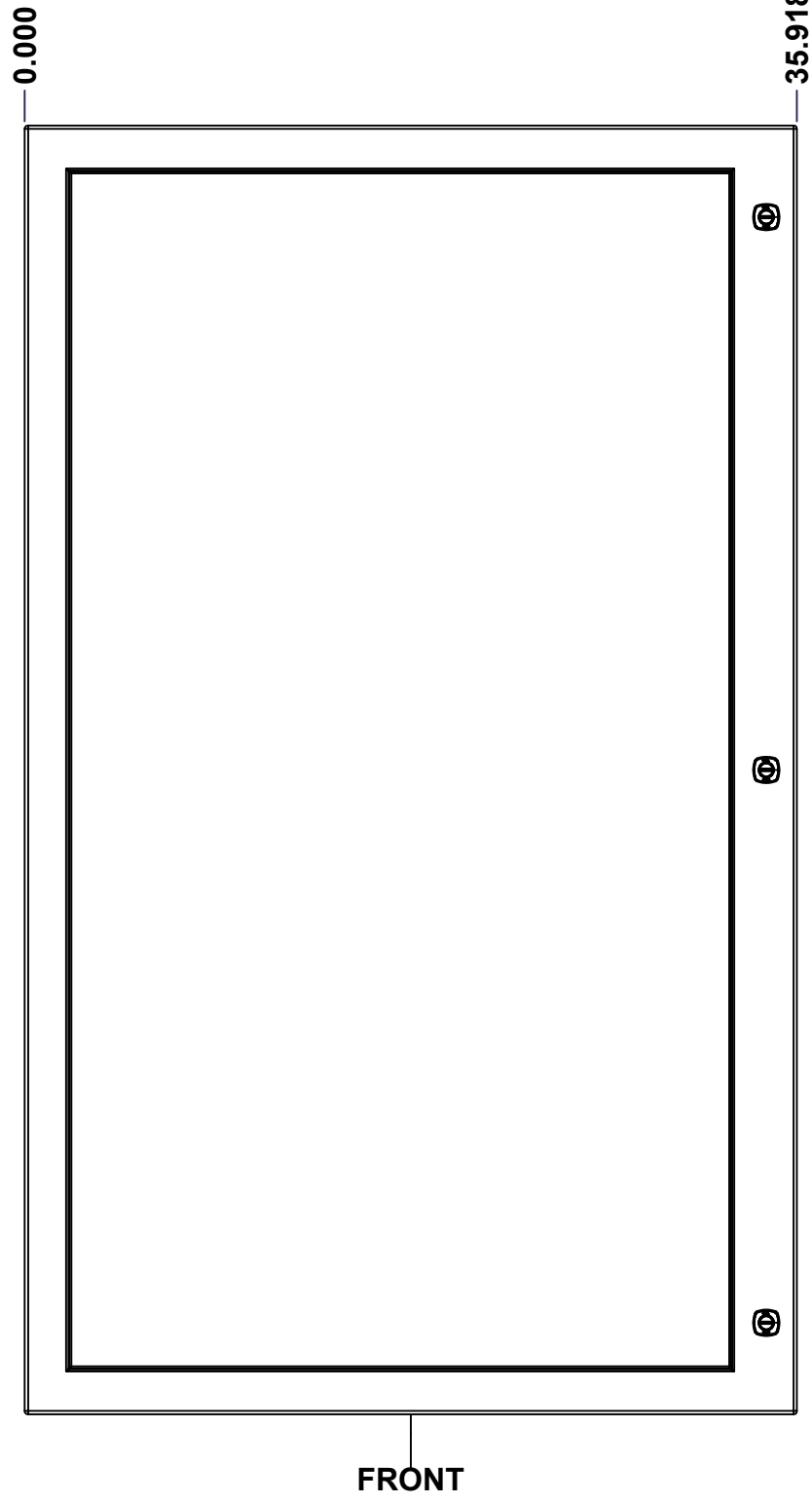
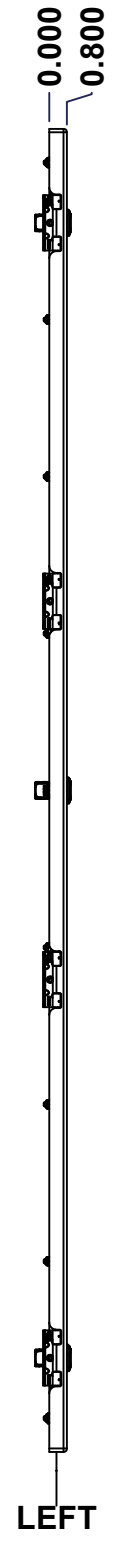
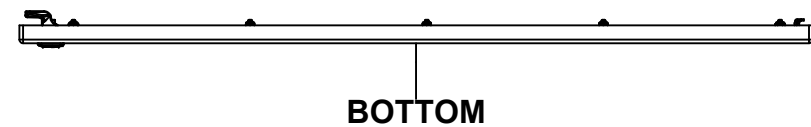
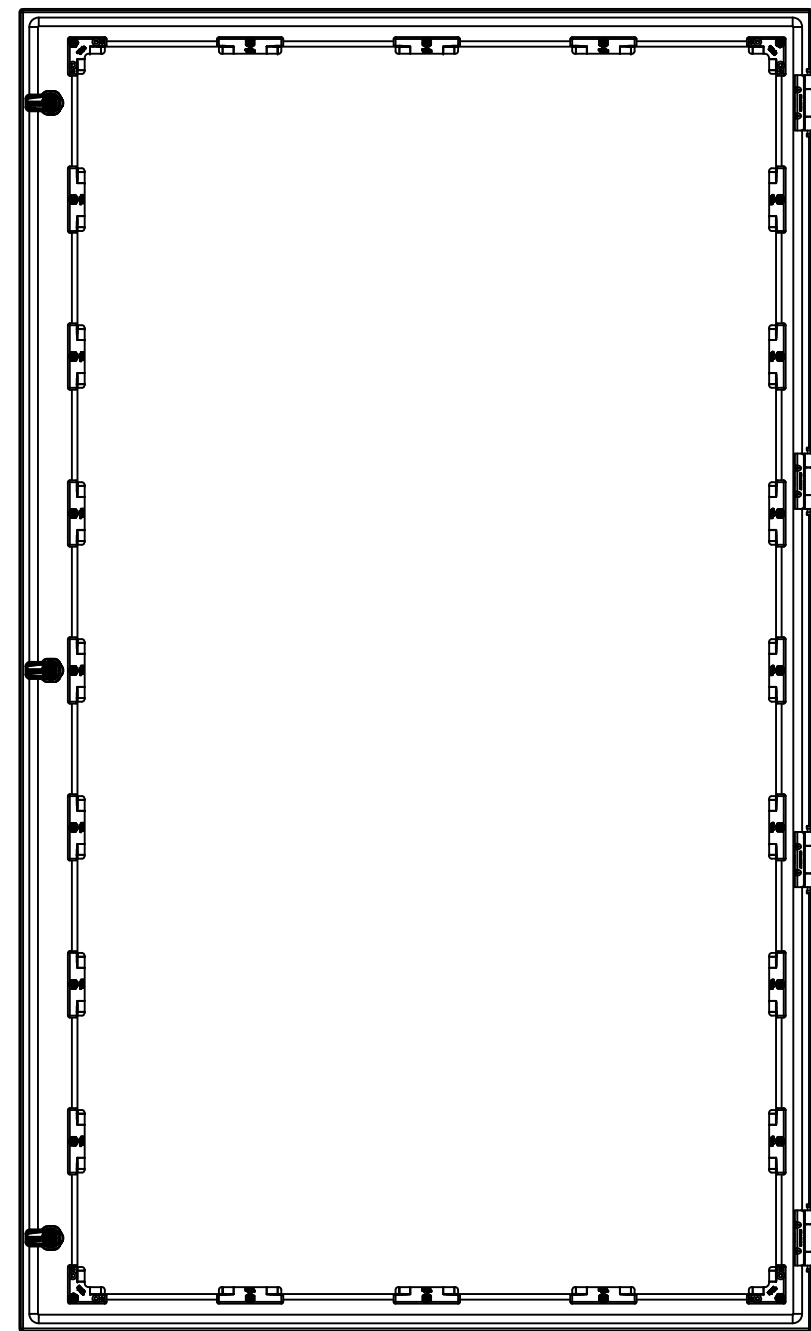
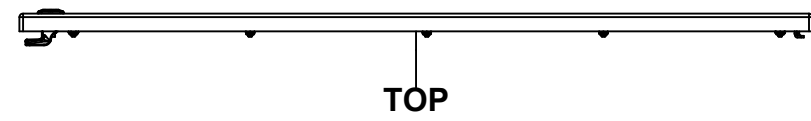

No.	Revisions	Date	By/Par

Isometric View

<p>Tél: (450) 979-4373 Fax: (450) 979-4626 www.exmweb.com</p>		Flatness Aplatissement	
		Max 3.0mm	
Customer Client		Projection	
Date			
Drawn By Dessiné Par BoxCad: BoxCad		Date 01-May-13	
Material Matière 14 Ga Stainless Steel 304 (1.7mm)			
Color Couleur Unpainted		Finish Fini Brushed	
Description 5412ESSW 60" x 36" Cover		Detail Rev.	
Part Number Numéro Pièce 5412ESSW603616C		Rev. 0	1 3

SEE BILL OF MATERIAL ON LAST PAGE

This drawing is confidential and must not be reproduced or used without the consent of EXM

Ce dessin est confidentiel et ne doit pas être reproduit ou utilisé sans le consentement de EXM

STANDARD FEATURES ARE NOT LISTED IN THIS HOLE TABLE			
HOLE TABLE - FRONT VIEW (CUSTOM FEATURE ONLY)			
CUT-OUT	XDIM	YDIM	DESCRIPTION
1	1.469	8.621	STUD M6 x 18mm (Inside)
2	33.468	8.621	STUD M6 x 18mm (Inside)
3	1.469	15.714	STUD M6 x 18mm (Inside)
4	33.468	15.714	STUD M6 x 18mm (Inside)
5	1.469	22.808	STUD M6 x 18mm (Inside)
6	33.468	22.808	STUD M6 x 18mm (Inside)
7	1.469	29.902	STUD M6 x 18mm (Inside)
8	33.468	29.902	STUD M6 x 18mm (Inside)
9	1.469	36.995	STUD M6 x 18mm (Inside)
10	33.468	36.995	STUD M6 x 18mm (Inside)
11	1.469	44.089	STUD M6 x 18mm (Inside)
12	33.468	44.089	STUD M6 x 18mm (Inside)
13	1.469	51.182	STUD M6 x 18mm (Inside)
14	33.468	51.182	STUD M6 x 18mm (Inside)
15	1.469	58.276	STUD M6 x 18mm (Inside)
16	1.469	1.527	STUD M6 x 18mm (Inside)
17	9.469	58.276	STUD M6 x 18mm (Inside)
18	9.469	1.527	STUD M6 x 18mm (Inside)
19	17.469	58.276	STUD M6 x 18mm (Inside)
20	17.469	1.527	STUD M6 x 18mm (Inside)
21	25.468	58.276	STUD M6 x 18mm (Inside)
22	25.468	1.527	STUD M6 x 18mm (Inside)
23	33.468	58.276	STUD M6 x 18mm (Inside)
24	33.468	1.527	STUD M6 x 18mm (Inside)

25	34.494	55.553	LOCK 880 SCQ4-SLSS6 @ 0.0°
26	34.494	29.902	LOCK 880 SCQ4-SLSS6 @ 0.0°
27	34.494	4.250	LOCK 880 SCQ4-SLSS6 @ 0.0°

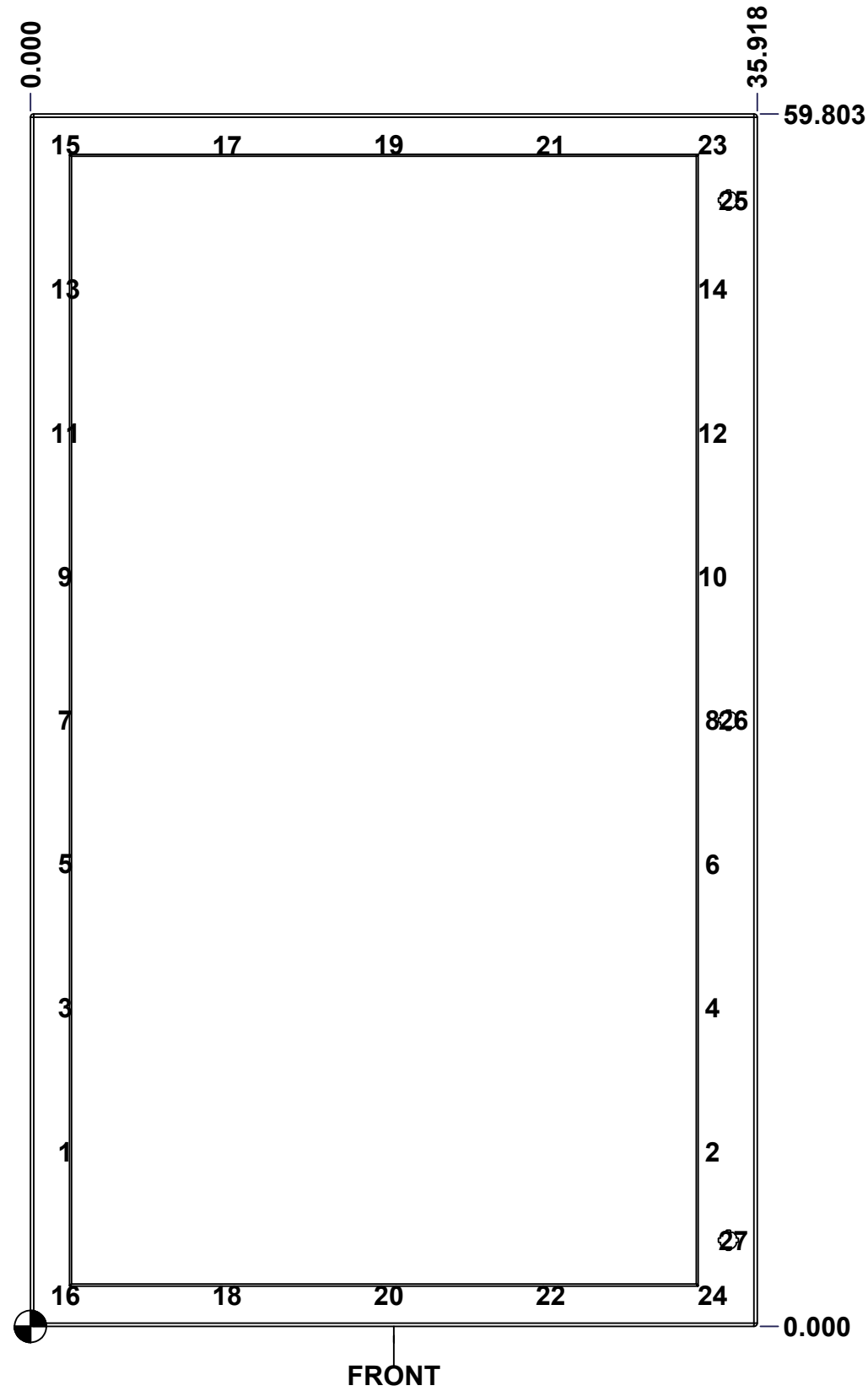

	Description	Status
	5412ESSW 60" x 36" Cover	(NULL)
	Part Number Numéro Pièce	Rev.
	5412ESSW603616C	0
		2 3

This drawing is confidential and must not be reproduced or used without the consent of EXM

Tolerance ±1/32" unless otherwise specified

C:\Vault Workspace\Inventor Dwg\Inv-8\881SP\881SP6036G.idw

Tolérance ±1/32" sauf spécification contraire

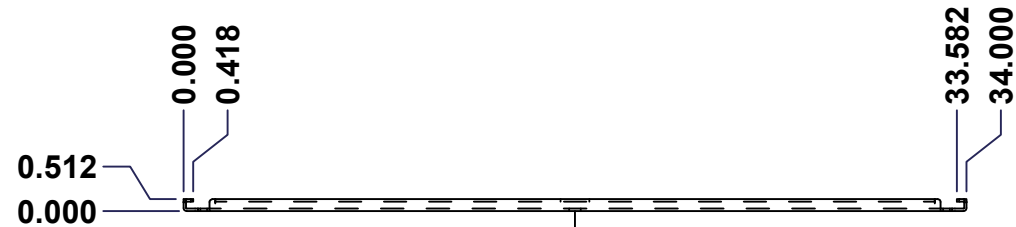

TOP

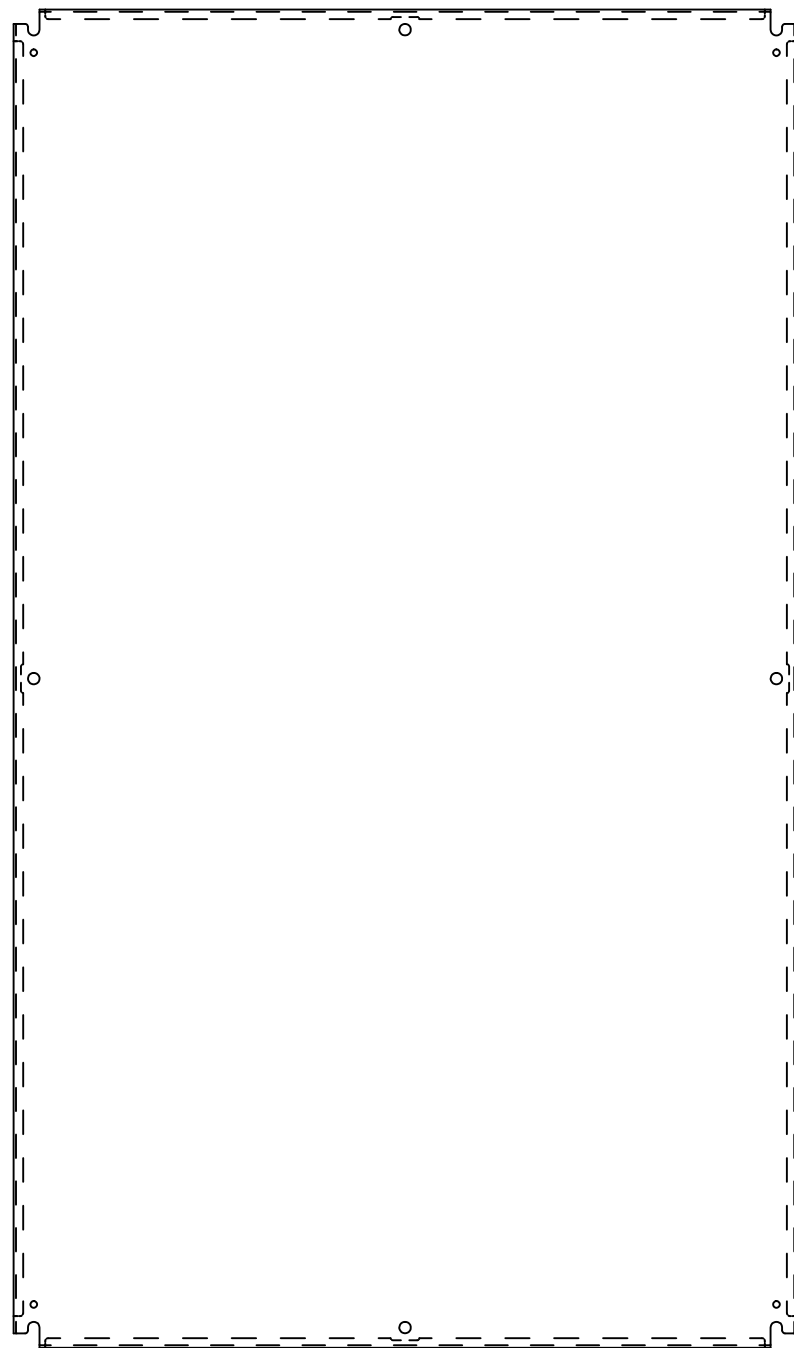

FRONT

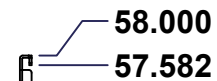

RIGHT

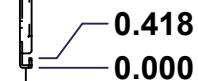

No.	Revisions	Date	By/Par

Isometric View

Ce dessin est confidentiel et ne doit pas être reproduit ou utilisé sans le consentement de EXM

		Tél: (450) 979-4373 Fax: (450) 979-4626 www.exmweb.com		Flatness Aplatissement Max 3.0mm	
Customer Client		Date		Projection 	
Drawn By Dessiné Par: BoxCad		Date: 1/23/2007		Material Matière: See Part List	
Color Couleur: See Part List		Finish Fini: See Part List		Description 881 SP - Inner Panel	
Part Number Numéro Pièce: 881 SP6036G		Detail Rev.		Rev. 1 0	

Qty	Part Number	Rev	Description	Material	Color	Finish
1	881 SP6036G-P	0	881 SP - Inner Panel Part	12 Ga Galvanized	Unpainted	Galvanized

Parts List

This drawing is confidential and must not be reproduced or used without the consent of EXM

Ce dessin est confidentiel et ne doit pas être reproduit ou utilisé sans le consentement de EXM

Table 1			FRONT VIEW
CUT-OUT	XDIM	YDIM	DESCRIPTION
1	17.000	0.875	MTG STUD HOLE (RND Ø0.500)
2	0.875	29.000	MTG STUD HOLE (RND Ø0.500)
3	33.125	29.000	MTG STUD HOLE (RND Ø0.500)
4	17.000	57.125	MTG STUD HOLE (RND Ø0.500)
5	0.875	1.875	GROUND HOLE (RND Ø0.290)
6	33.125	1.875	GROUND HOLE (RND Ø0.290)
7	0.875	56.125	GROUND HOLE (RND Ø0.290)
8	33.125	56.125	GROUND HOLE (RND Ø0.290)

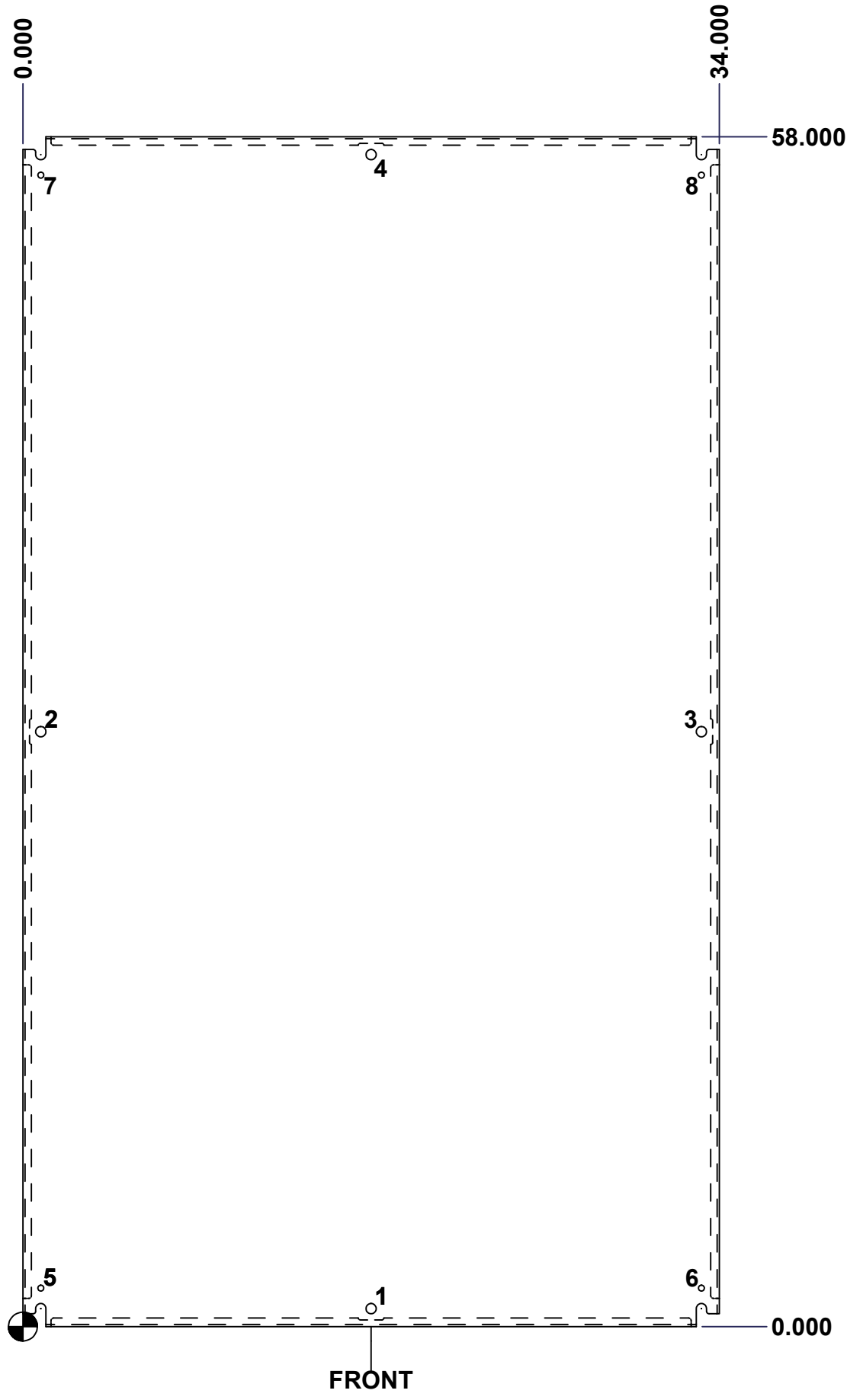

All knockouts are actual size / Les disques défonçables sont grandeur réel

No.	Revisions	Date	By/Par

Isometric View

		Tél: (450) 979-4373 Fax: (450) 979-4626 www.exmweb.com		Flatness Aplatissement Max 3.0mm
Customer Client		Date		Projection
Drawn By Dessiné Par		BoxCad		Date 1/23/2007
Material Matière		See Part List		
Color Couleur		See Part List		Finish Fini
Description		Detail Rev.		
881 SP - Inner Panel		Rev. 2		
Part Number Numéro Pièce		881 SP6036G		Rev. 0