

This drawing is confidential and must not be reproduced or used without the consent of EXM

Ce dessin est confidentiel et ne doit pas être reproduit ou utilisé sans le consentement de EXM

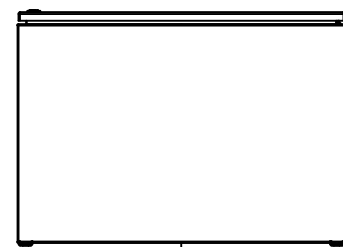

TOP

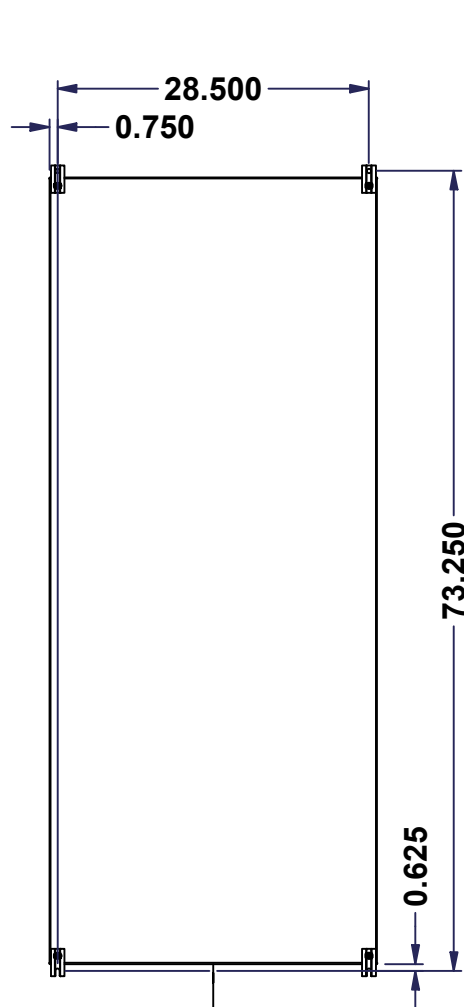

BACK

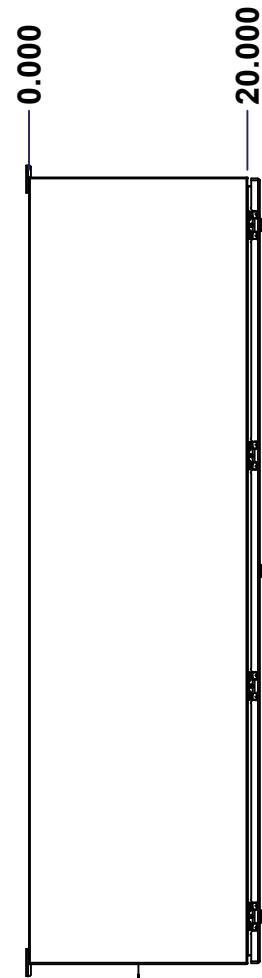

LEFT

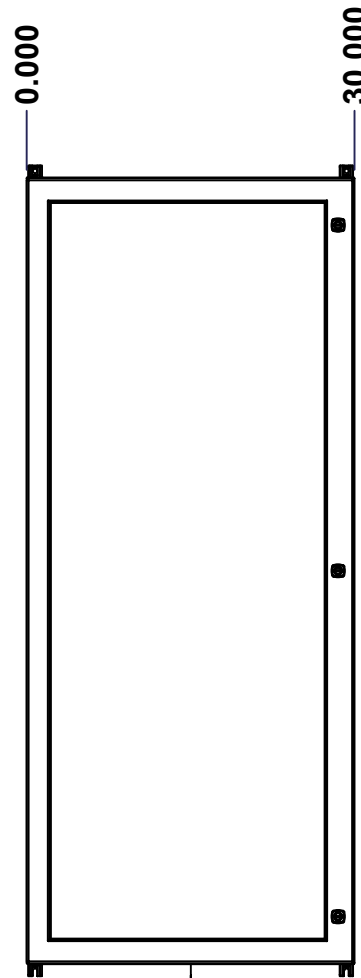

FRONT

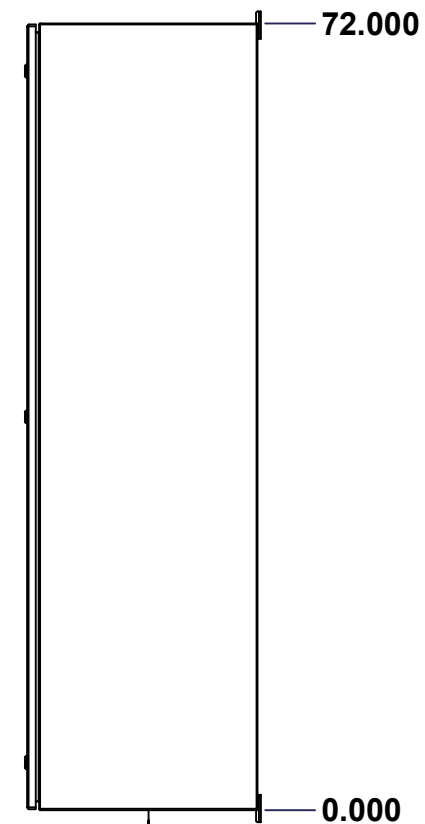

RIGHT



BOTTOM

No.	Revisions	Date	By/Par

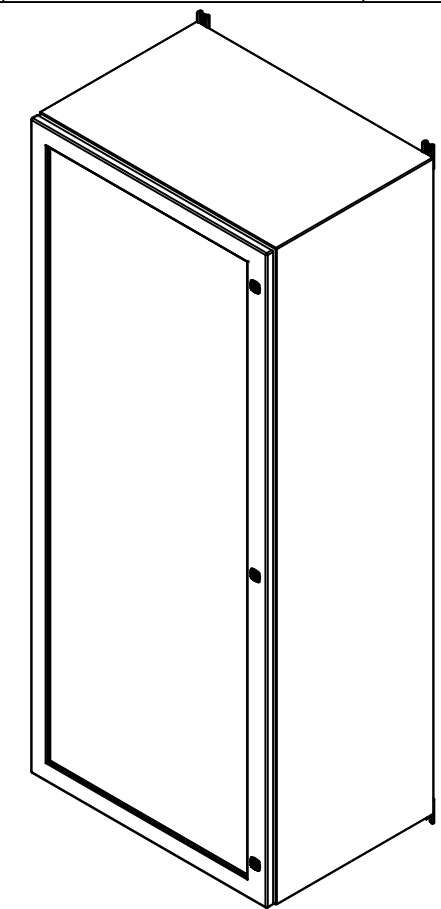

Isometric View



**GRAIN DIRECTION:
TOP/BOTTOM: HORIZONTAL
LEFT/RIGHT/BACK/FRONT: VERTICAL**

Tél: (450) 979-4373 Fax: (450) 979-4626 www.exmweb.com		Flatness Aplatissement Max 3.0mm Projection
Customer Client	Date	
Drawn By Dessiné Par	BoxCad: BoxCad	Date 05-Jun-23
Material Matière	14 Ga Stainless Steel 316 (1.7mm)	
Color Couleur	Unpainted	Finish Fini Brushed
Description	Detail Rev.	
5412ESSW 72" x 30" x 20" Assembly		
Part Number Numéro Pièce	Rev. 0	1 / 15

SEE BILL OF MATERIAL ON LAST PAGE 5412ESSW7230206THNOIP

This drawing is confidential and must not be reproduced or used without the consent of EXM

Ce dessin est confidentiel et ne doit pas être reproduit ou utilisé sans le consentement de EXM

NOTE	
ITEM	DESCRIPTION
1	NEMA 4X Enclosure
2	C/W Standard ground studs on box and cover
3	W/O Standard door stiffener
4	W/O Inner panel
5	C/W Standard inner panel mounting studs
6	C/W 885 ESMF4_OPEN Sold separately (Installed)
7	C/W 885 ESMF4_CLOSE Sold separately (Installed)
8	C/W R5 Insulation (Installed by EXM)

No.	Revisions	Date	By/Par

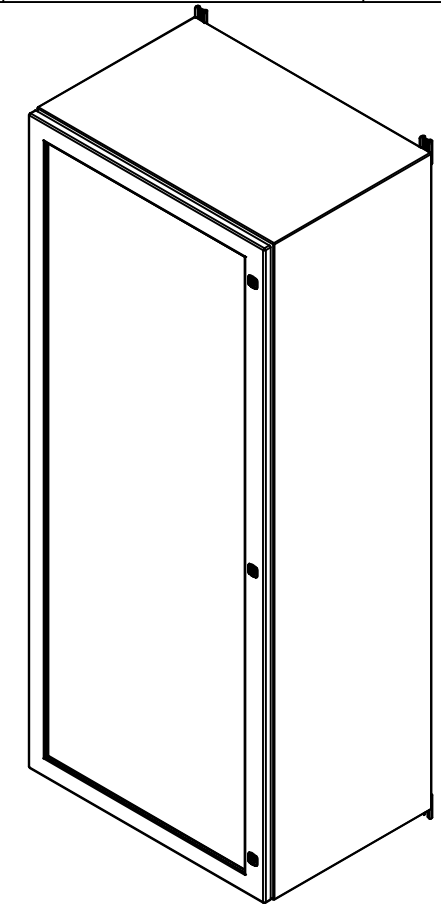

Isometric View

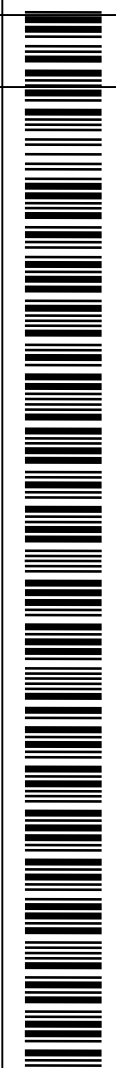

PACKING		
ITEM	QTY	DESCRIPTION
Cardboard sleeve	2	Top and Bottom
Cardboard strip	2	Between back of enclosure and inner panel
Plastic bag	1	To protect cover surface and inside gasket
Cardboard corner	4	To reinforced for the plastic strap tightening
Plastic strap - Black	2	To Squeeze the 2 cardboard sleeve together
Packaging label	3	White label with PN
Plastic strap- Green	2	To secure the enclosure to the wood pallet
Wood Pallet	1	2" deeper and 3" larger than enclosure size

6	STK-Q-00600	2	M12 to M8 Adaptor
1	STK-K-01800	5	5412 ES Accessory Kit
1	5412ESSW7230206THNO IPC	0	5412ESSW 72" x 30" Cover
1	5412ESSW7230206THNO IPB	0	5412ESSW 72" x 30" x 20" Body
4	STK-Q-04051-08	1	M6 x 8mm Stainless Steel Hexagon Socket Head Machine Screw with Nyseal
Qty	Part Number	Rev	Description
Parts List			

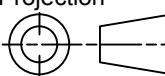
 Tél: (450) 979-4373 Fax: (450) 979-4626 www.exmweb.com		Flatness Aplatissement Max 3.0mm Projection 
Customer Client	Date	
Drawn By Dessiné Par	BoxCad: BoxCad	Date 05-Jun-23
Material Matière	14 Ga Stainless Steel 316 (1.7mm)	
Color Couleur	Unpainted	Finish Fini Brushed
Description	Detail Rev.	
5412ESSW 72" x 30" x 20" Assembly		
Part Number Numéro Pièce	Rev.	2
5412ESSW7230206THNOIP	0	15

This drawing is confidential and must not be reproduced or used without the consent of EXM

Ce dessin est confidentiel et ne doit pas être reproduit ou utilisé sans le consentement de EXM

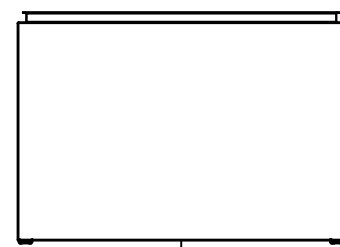

TOP

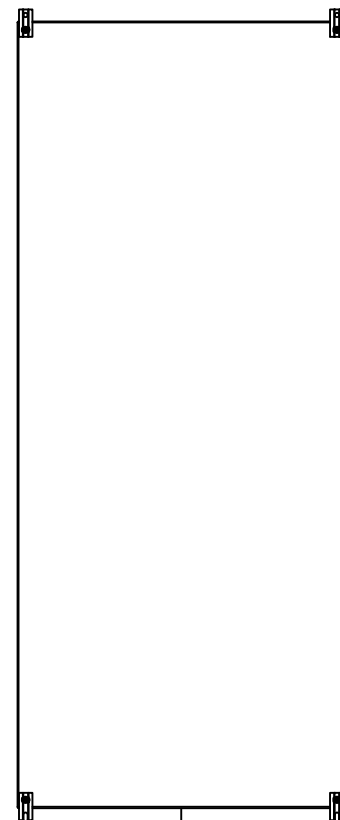

BACK

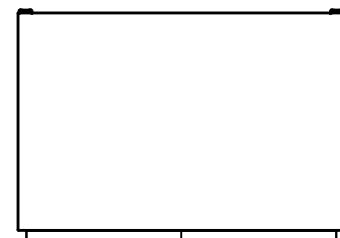

BOTTOM

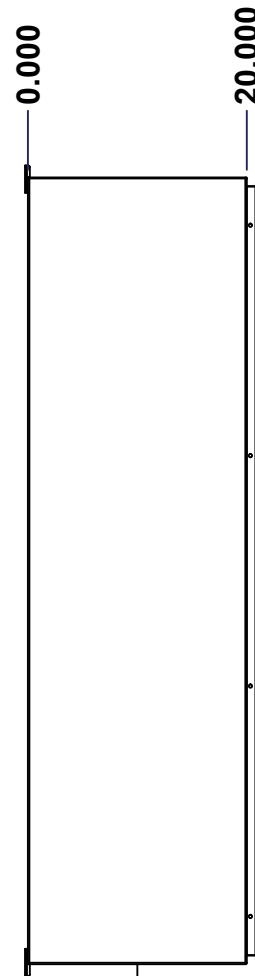

LEFT

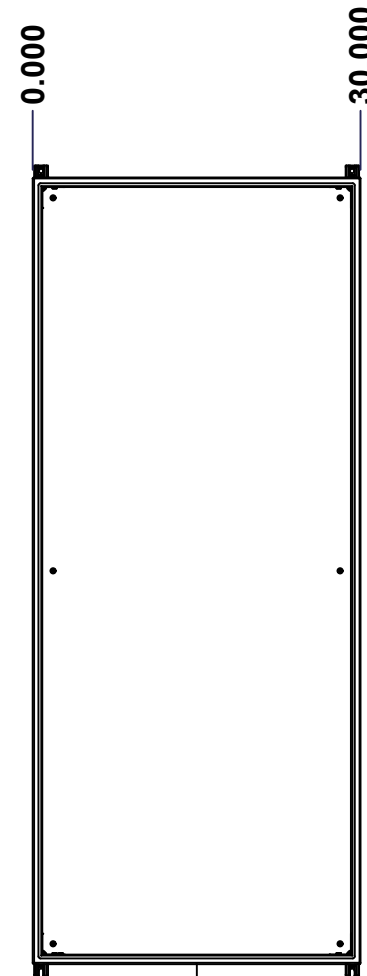

FRONT

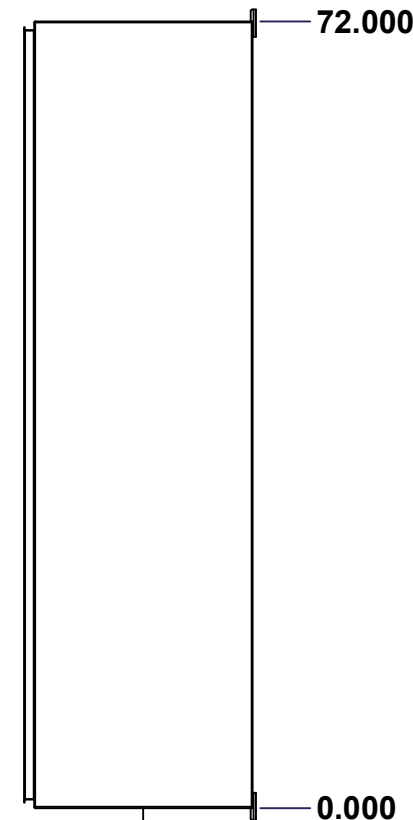

RIGHT

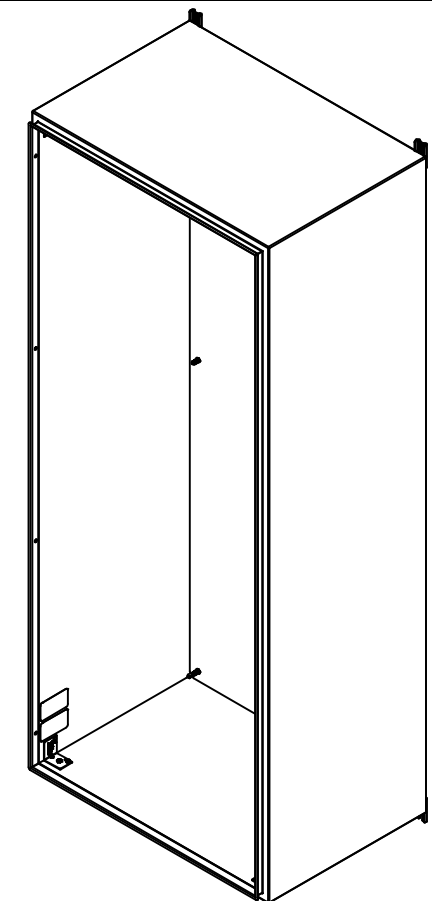

Isometric View



No.	Revisions	Date	By/Par

Tél: (450) 979-4373 Fax: (450) 979-4626 www.exmweb.com		Flatness Aplatissement Max 5.0mm Projection
Customer Client	Date	
Drawn By Dessiné Par	BoxCad: BoxCad	Date 05-Jun-23
Material Matière	14 Ga Stainless Steel 316 (1.7mm)	
Color Couleur	Unpainted	Finish Fini Brushed
Description	Detail Rev.	
5412ESSW 72" x 30" x 20" Body		
Part Number Numéro Pièce	Rev. 3	0

This drawing is confidential and must not be reproduced or used without the consent of EXM

Ce dessin est confidentiel et ne doit pas être reproduit ou utilisé sans le consentement de EXM

STANDARD FEATURES ARE NOT LISTED IN THIS HOLE TABLE			
HOLE TABLE - TOP VIEW (CUSTOM FEATURE ONLY)			
CUT-OUT	XDIM	YDIM	DESCRIPTION
1	2.000	18.500	INSUL. STUD M6 x 18mm (Inside)
2	28.000	18.500	INSUL. STUD M6 x 18mm (Inside)

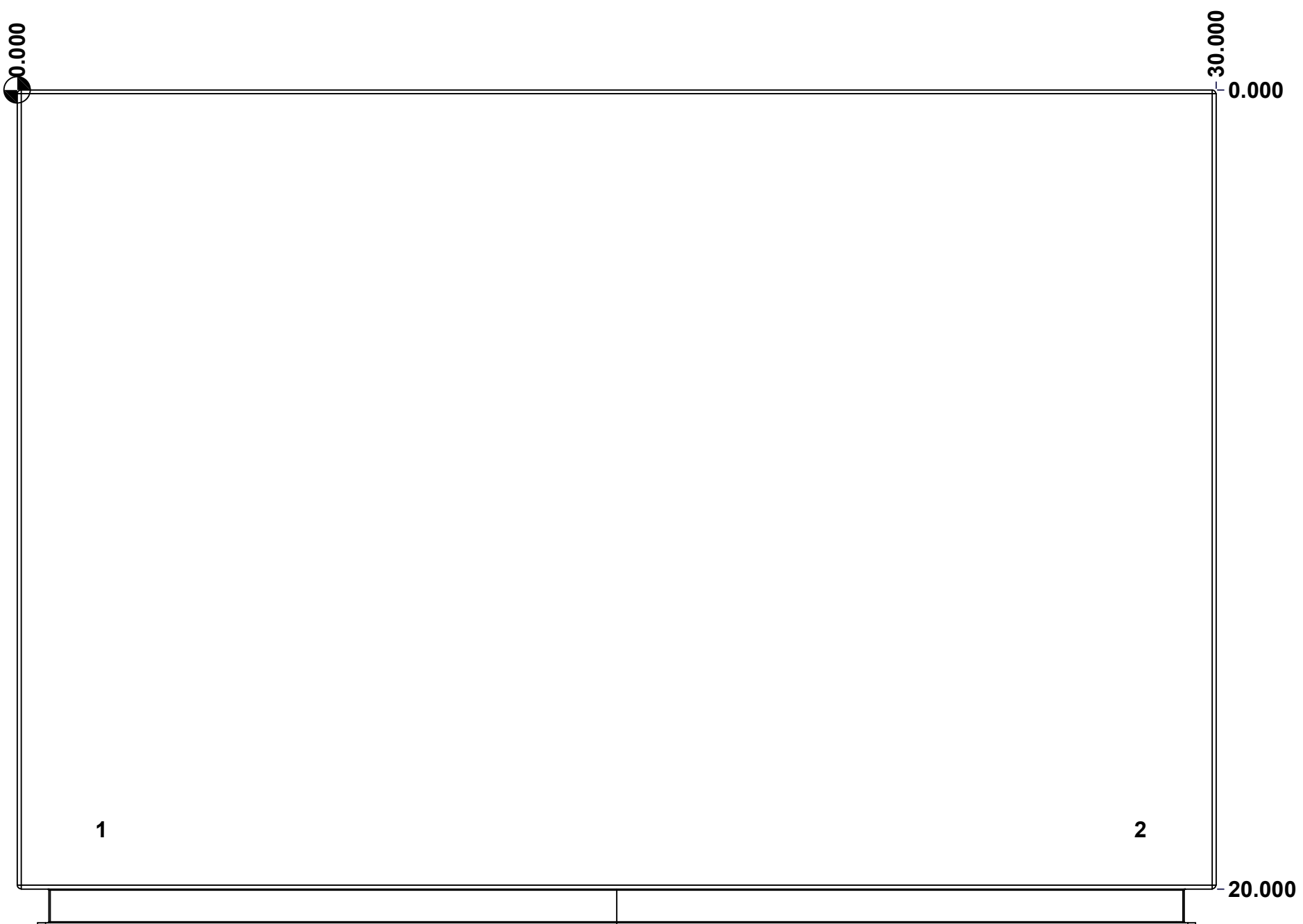

	Description	Status
	5412ESSW 72" x 30" x 20" Body	(NULL)
	Part Number Numéro Pièce	Rev.
5412ESSW7230206THNOIPB 0		4
		15

This drawing is confidential and must not be reproduced or used without the consent of EXM

Ce dessin est confidentiel et ne doit pas être reproduit ou utilisé sans le consentement de EXM

STANDARD FEATURES ARE NOT LISTED IN THIS HOLE TABLE			
HOLE TABLE - BOTTOM VIEW (CUSTOM FEATURE ONLY)			
CUT-OUT	XDIM	YDIM	DESCRIPTION
1	2.000	18.500	INSUL. STUD M6 x 18mm (Inside)
2	28.000	18.500	INSUL. STUD M6 x 18mm (Inside)

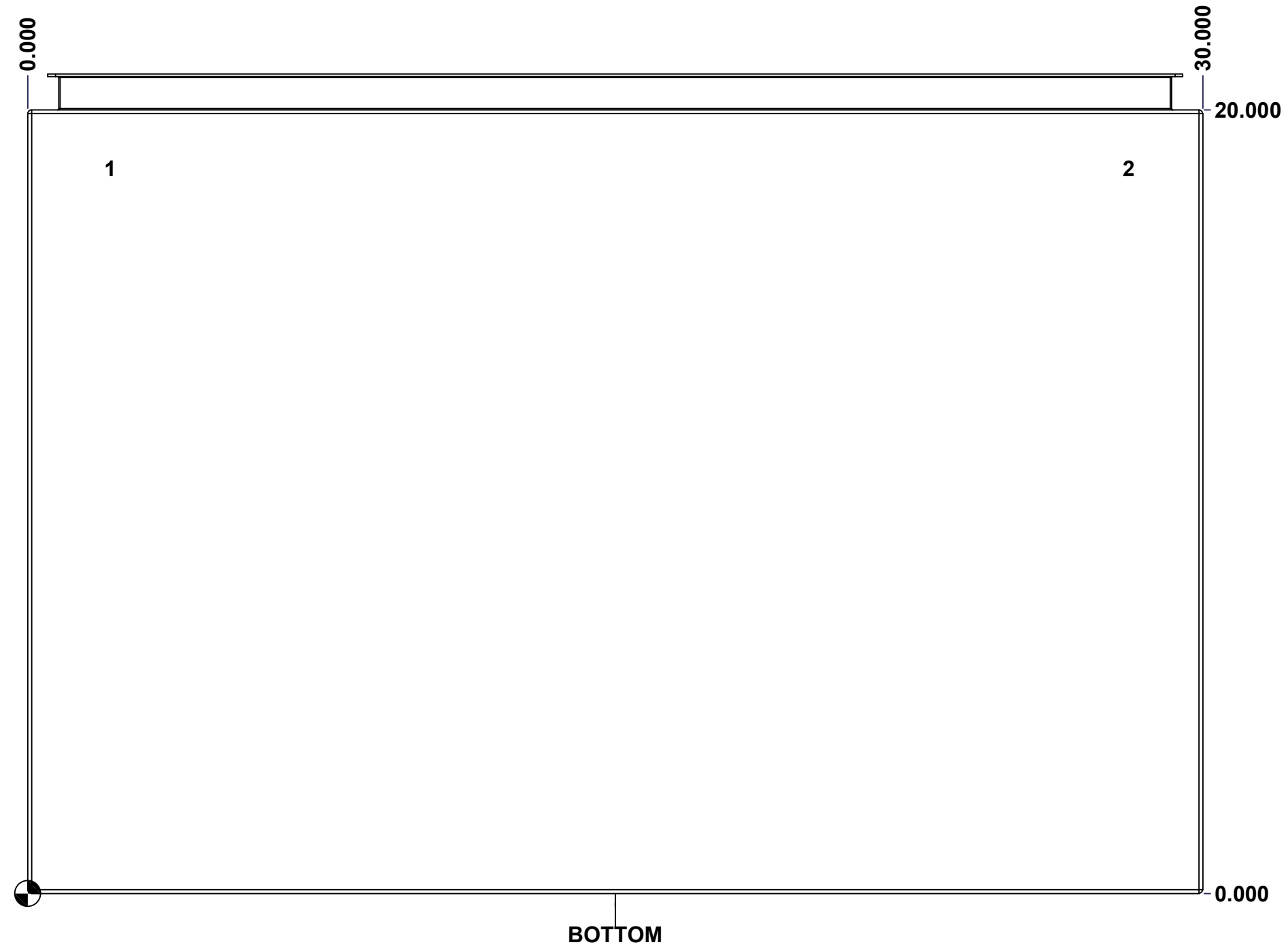

	Description	Status
	5412ESSW 72" x 30" x 20" Body	(NULL)
	Part Number Numéro Pièce	Rev. 5
	5412ESSW7230206THNOIPB 0	15

This drawing is confidential and must not be reproduced or used without the consent of EXM

Ce dessin est confidentiel et ne doit pas être reproduit ou utilisé sans le consentement de EXM

STANDARD FEATURES ARE NOT LISTED IN THIS HOLE TABLE

HOLE TABLE - BACK VIEW (CUSTOM FEATURE ONLY)

CUT-OUT	XDIM	YDIM	DESCRIPTION
1	1.875	1.875	IP STUD M8 x 35mm (Inside)
2	1.875	70.125	IP STUD M8 x 35mm (Inside)
3	28.125	70.125	IP STUD M8 x 35mm (Inside)
4	28.125	1.875	IP STUD M8 x 35mm (Inside)
5	1.875	36.000	IP STUD M8 x 35mm (Inside)
6	28.125	36.000	IP STUD M8 x 35mm (Inside)

7	29.250	0.000	FOOT 885 ESMF4_OPEN
8	0.750	0.000	FOOT 885 ESMF4_OPEN
9	29.250	72.000	FOOT 885 ESMF4_CLOSE
10	0.750	72.000	FOOT 885 ESMF4_CLOSE

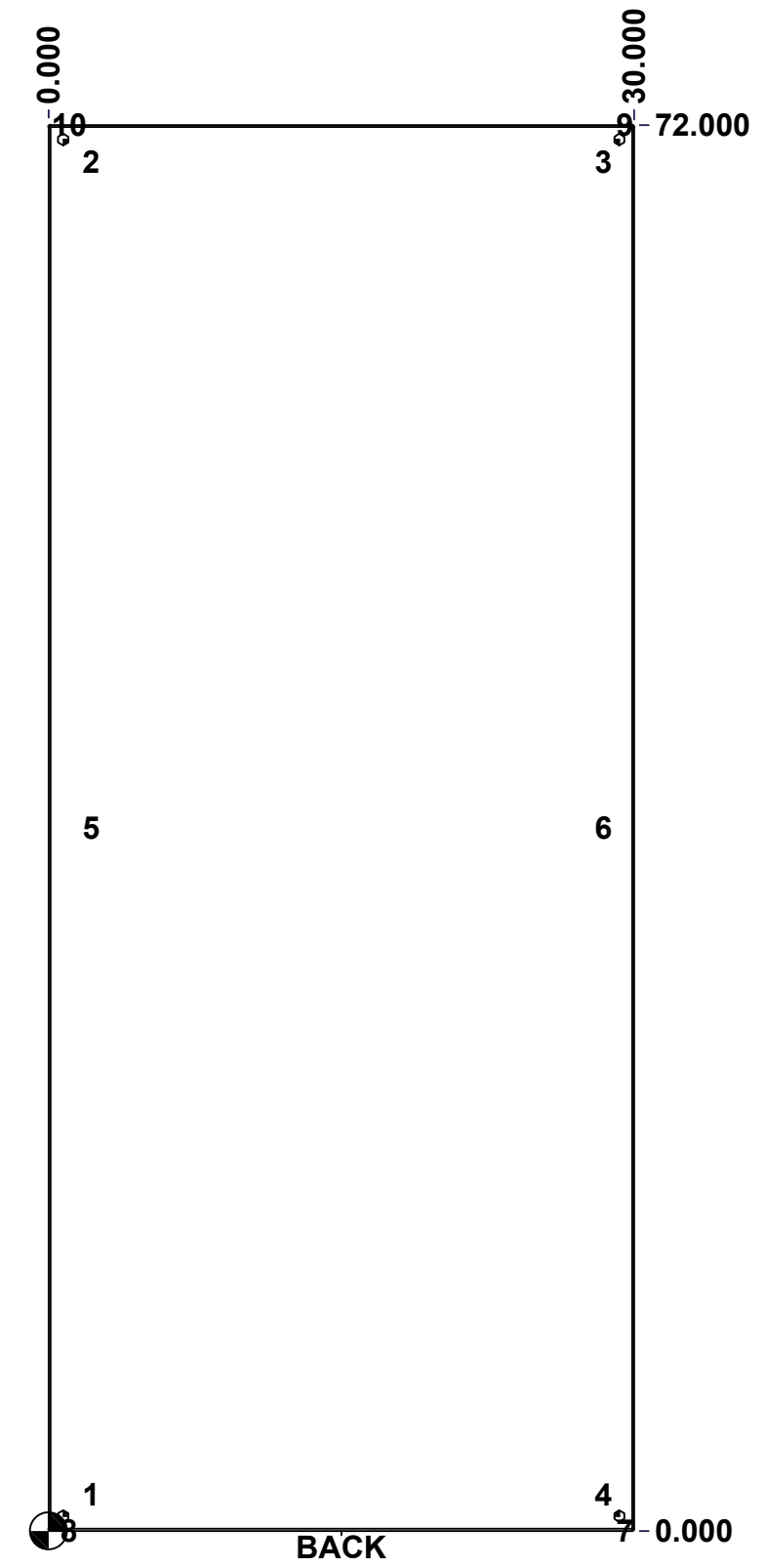

	Description	Status
	5412ESSW 72" x 30" x 20" Body	(NULL)
	Part Number Numéro Pièce	Rev. 6
	5412ESSW7230206THNOIPB 0	15

This drawing is confidential and must not be reproduced or used without the consent of EXM

Ce dessin est confidentiel et ne doit pas être reproduit ou utilisé sans le consentement de EXM

No.	Revisions	Date	By/Par

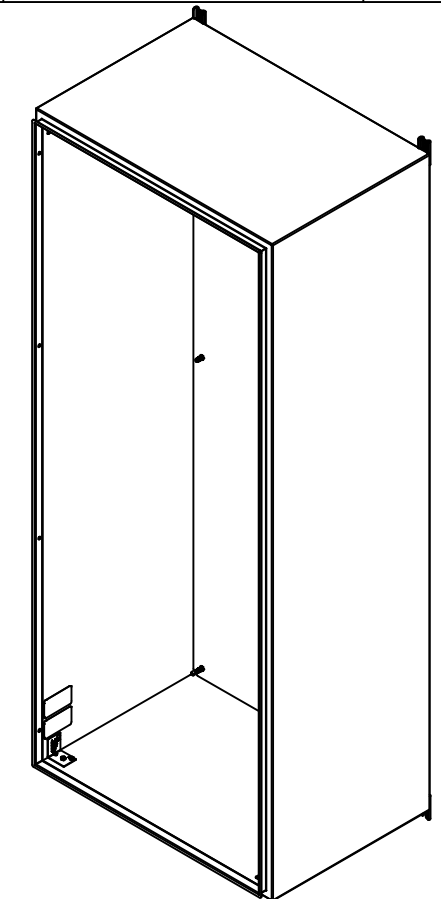

Isometric View



2	885ESMF4-FEET	0	885 ESMF4 Stainless Steel Mounting Foot
4	RIVET_NUT_SS_M10_FH_CE	0	Stainless Steel Rivet Nut M10 (Low Profile Close End)
4	STK-Q-06670	2	M10 x 16mm Stainless Steel Machine Screw
2	885ESMF4-FEET-A	0	885 ESMF4 Stainless Steel Mounting Foot (Opened Slot)
2	STK-S-00100	0	3.5" x 2" Silver Milar Flexcon Sticker
1	STK-K-70554	3	5412 ESTH Accessory Kit
1	5412ESSW7230206THNO IPI-RS	0	5412ESSW 72" x 30" Right Insulation
1	5412ESSW7230206THNO IPI-LS	0	5412ESSW 72" x 30" Left Insulation
1	5412ESSW7230206THNO IPI-BT	0	5412ESSW 72" x 30" Top and Bottom Insulation
1	5412ESSW7230206THNO IPI-TP	0	5412ESSW 72" x 30" Top and Bottom Insulation
1	5412ESSW7230206THNO IPI-B	0	5412ESSW 72" x 30" Back Insulation
4	STK-Q-16070	1	Stud M6 x 18mm Stainless steel
6	STK-Q-16020	1	Stud M8 x 35mm Stainless Steel
1	5412ESSW7230206THNO IPB-P	0	5412ESSW 72" x 30" x 20" Body Part

Qty	Part Number	Rev	Description
Parts List			



Tél: (450) 979-4373
Fax: (450) 979-4626
www.exmweb.com

Flatness
Aplatissement
Max 5.0mm

Projection

Customer Client	Date
Drawn By Dessiné Par BoxCad: BoxCad	Date 05-Jun-23
Material Matière 14 Ga Stainless Steel 316 (1.7mm)	
Color Couleur Unpainted	Finish Fini Brushed
Description 5412ESSW 72" x 30" x 20" Body	Detail Rev.
Part Number Numéro Pièce	Rev. 7

5412ESSW7230206THNOIPB 0

This drawing is confidential and must not be reproduced or used without the consent of EXM

Ce dessin est confidentiel et ne doit pas être reproduit ou utilisé sans le consentement de EXM

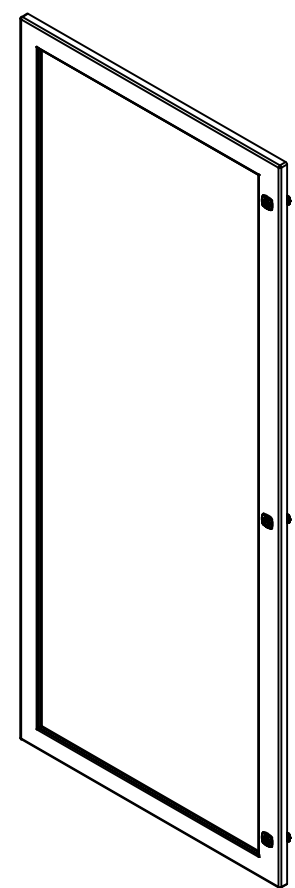
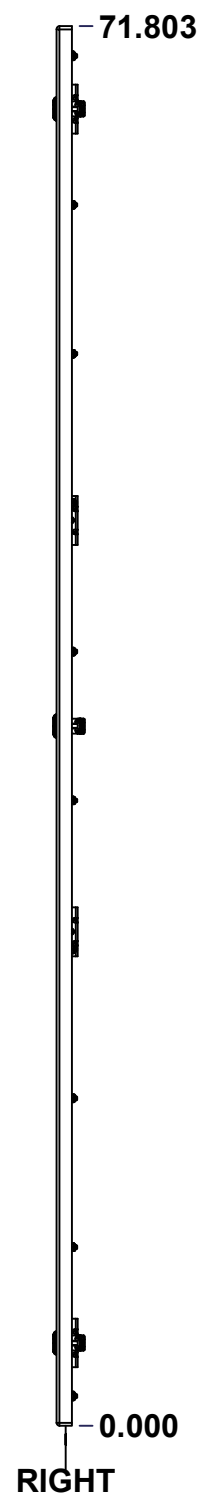
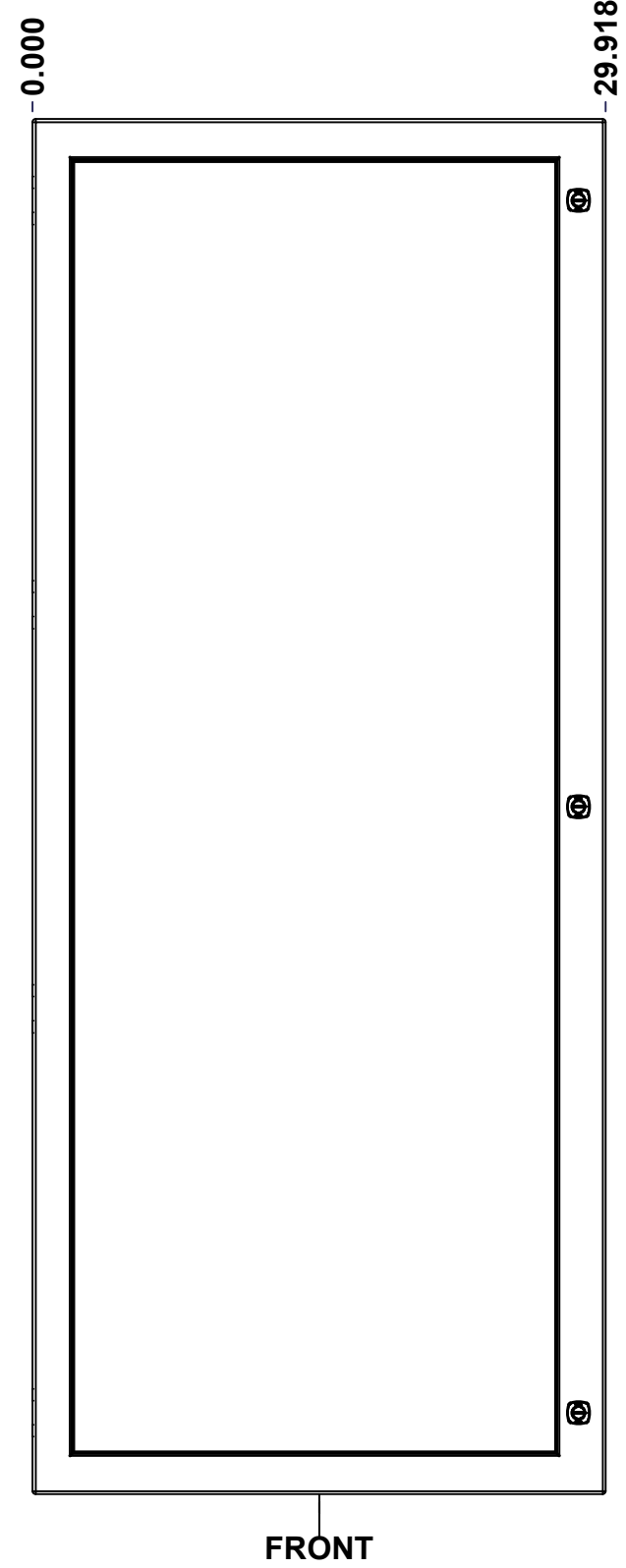
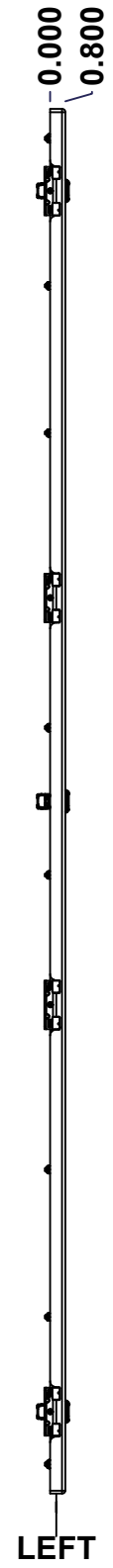
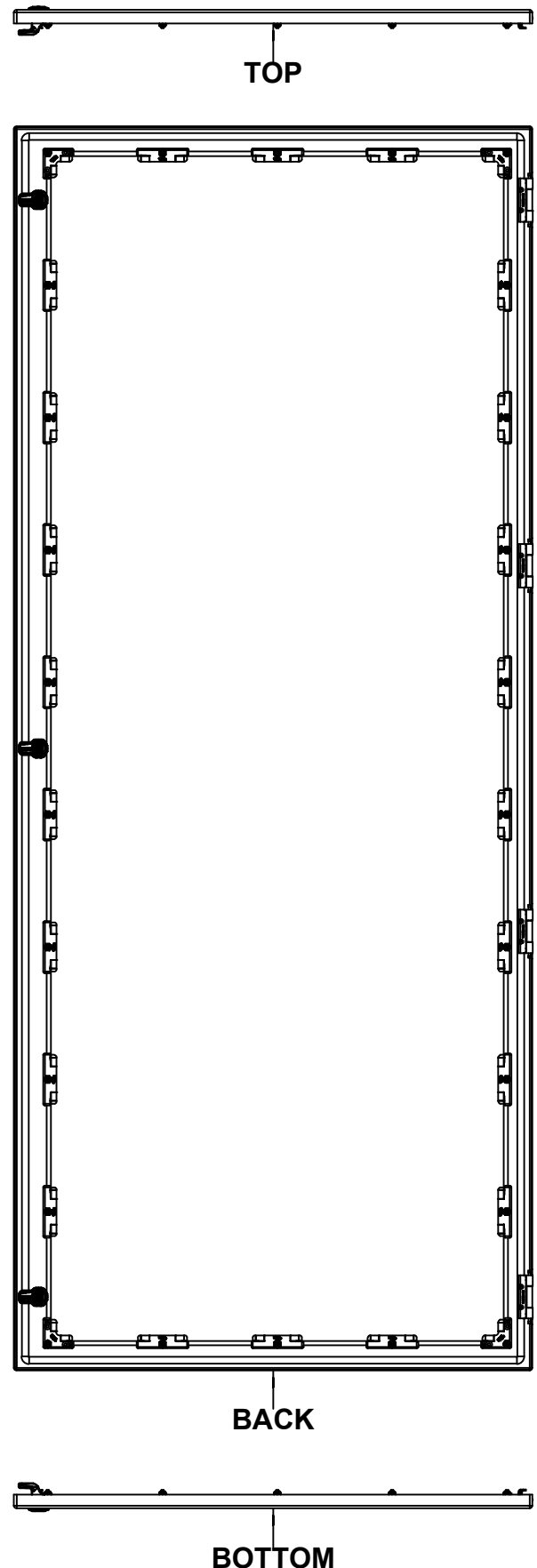

Isometric View

No.	Revisions	Date	By/Par



Tél: (450) 979-4373
 Fax: (450) 979-4626
www.exmweb.com

Flatness
 Aplatissement
 Max 5.0mm
 Projection

Customer Client	Date
Drawn By Dessiné Par BoxCad: BoxCad	Date 05-Jun-23
Material Matière 14 Ga Stainless Steel 316 (1.7mm)	
Color Couleur Unpainted	Finish Fini Brushed
Description 5412ESSW 72" x 30" Cover	Detail Rev.
Part Number Numéro Pièce	Rev. 8

SEE BILL OF MATERIAL ON LAST PAGE 5412ESSW7230206THNOIPC 0

This drawing is confidential and must not be reproduced or used without the consent of EXM

Ce dessin est confidentiel et ne doit pas être reproduit ou utilisé sans le consentement de EXM

STANDARD FEATURES ARE NOT LISTED IN THIS HOLE TABLE

HOLE TABLE - FRONT VIEW (CUSTOM FEATURE ONLY)

CUT-OUT	XDIM	YDIM	DESCRIPTION
1	1.469	9.166	STUD M6 x 18mm (Inside)
2	27.968	9.166	STUD M6 x 18mm (Inside)
3	1.469	16.805	STUD M6 x 18mm (Inside)
4	27.968	16.805	STUD M6 x 18mm (Inside)
5	1.469	24.443	STUD M6 x 18mm (Inside)
6	27.968	24.443	STUD M6 x 18mm (Inside)
7	1.469	32.082	STUD M6 x 18mm (Inside)
8	27.968	32.082	STUD M6 x 18mm (Inside)
9	1.469	39.721	STUD M6 x 18mm (Inside)
10	27.968	39.721	STUD M6 x 18mm (Inside)
11	1.469	47.360	STUD M6 x 18mm (Inside)
12	27.968	47.360	STUD M6 x 18mm (Inside)
13	1.469	54.998	STUD M6 x 18mm (Inside)
14	27.968	54.998	STUD M6 x 18mm (Inside)
15	1.469	62.637	STUD M6 x 18mm (Inside)
16	27.968	62.637	STUD M6 x 18mm (Inside)
17	1.469	70.276	STUD M6 x 18mm (Inside)
18	1.469	1.527	STUD M6 x 18mm (Inside)
19	8.094	70.276	STUD M6 x 18mm (Inside)
20	8.094	1.527	STUD M6 x 18mm (Inside)
21	14.719	70.276	STUD M6 x 18mm (Inside)
22	14.719	1.527	STUD M6 x 18mm (Inside)
23	21.343	70.276	STUD M6 x 18mm (Inside)
24	21.343	1.527	STUD M6 x 18mm (Inside)
25	27.968	70.276	STUD M6 x 18mm (Inside)
26	27.968	1.527	STUD M6 x 18mm (Inside)

27	28.494	4.250	880 SCQ4-SLSS6
28	28.494	67.553	880 SCQ4-SLSS6
29	28.494	35.902	880 SCQ4-SLSS6

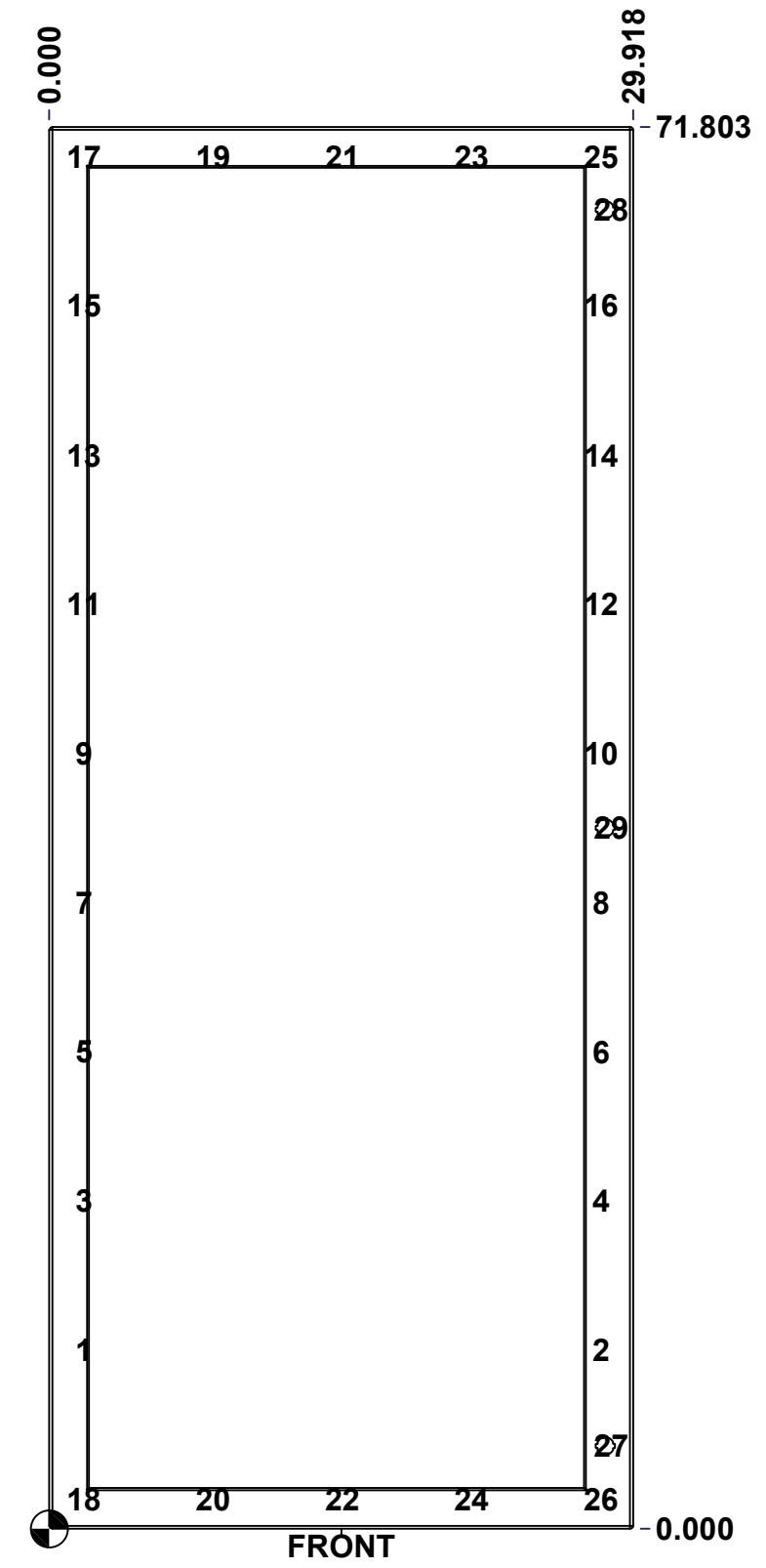

	Description	Status
	5412ESSW 72" x 30" Cover	(NULL)
	Part Number Numéro Pièce	Rev. 9
	5412ESSW7230206THNOIPC 0	15

This drawing is confidential and must not be reproduced or used without the consent of EXM

Ce dessin est confidentiel et ne doit pas être reproduit ou utilisé sans le consentement de EXM

No.	Revisions	Date	By/Par

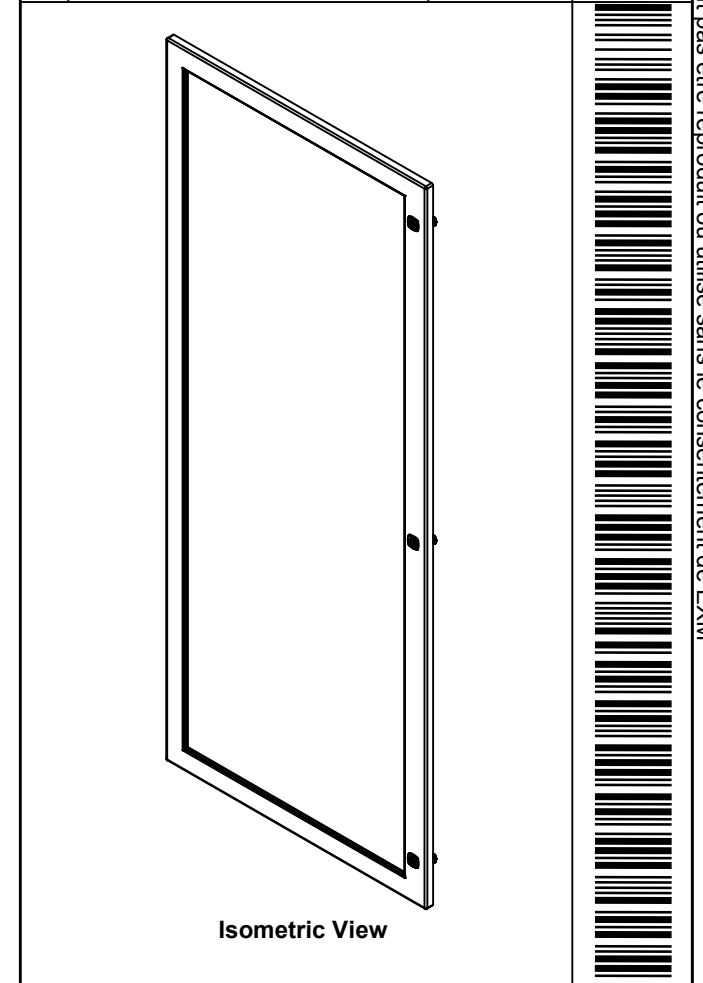

QTY	Part Number	Rev	Description
22	STK-Q-60701	2.1	880 WK - Lexan 1/4" Fixing Bracket
1	STK-A-60703	0	5412 ESW Lexan Bracket Kit
26	STK-Q-16053	1	Stud M6 x 23mm Stainless steel
1	STK-G-02710	0	880 HWKG - Windows Kit Gasket
1	5412ESSW7230206THNO IPLXG	0	5412ESSW 72" x 30" Lexan Gasket Part
1	5412ESSW7230206THNO IPLX	0	5412ESSW 68.375" x 26.125" Lexan Part
1	5412ESSW7230206THNO IPG	0	5412ESSW 72" x 30" Cover Gasket Part
1	5412ESSW7230206THNO IPC-P	0	5412ESSW 72" x 30" Cover Part
3	880 SCQ4-SLSS6	7	5412 ESS 1/4 Turn Lock
4	STK-A-33016	0	5412 ESS Bended Hinge (Body Part)
Parts List			

Tél: (450) 979-4373
Fax: (450) 979-4626
www.exmweb.com

Flatness
Aplatissement
Max 5.0mm

Projection

Customer Client	Date
Drawn By Dessiné Par BoxCad: BoxCad	Date 05-Jun-23
Material Matière 14 Ga Stainless Steel 316 (1.7mm)	
Color Couleur Unpainted	Finish Fini Brushed
Description 5412ESSW 72" x 30" Cover	
Part Number Numéro Pièce 5412ESSW7230206THNOIPC 0	Rev. 10

This drawing is confidential and must not be reproduced or used without the consent of EXM

Ce dessin est confidentiel et ne doit pas être reproduit ou utilisé sans le consentement de EXM

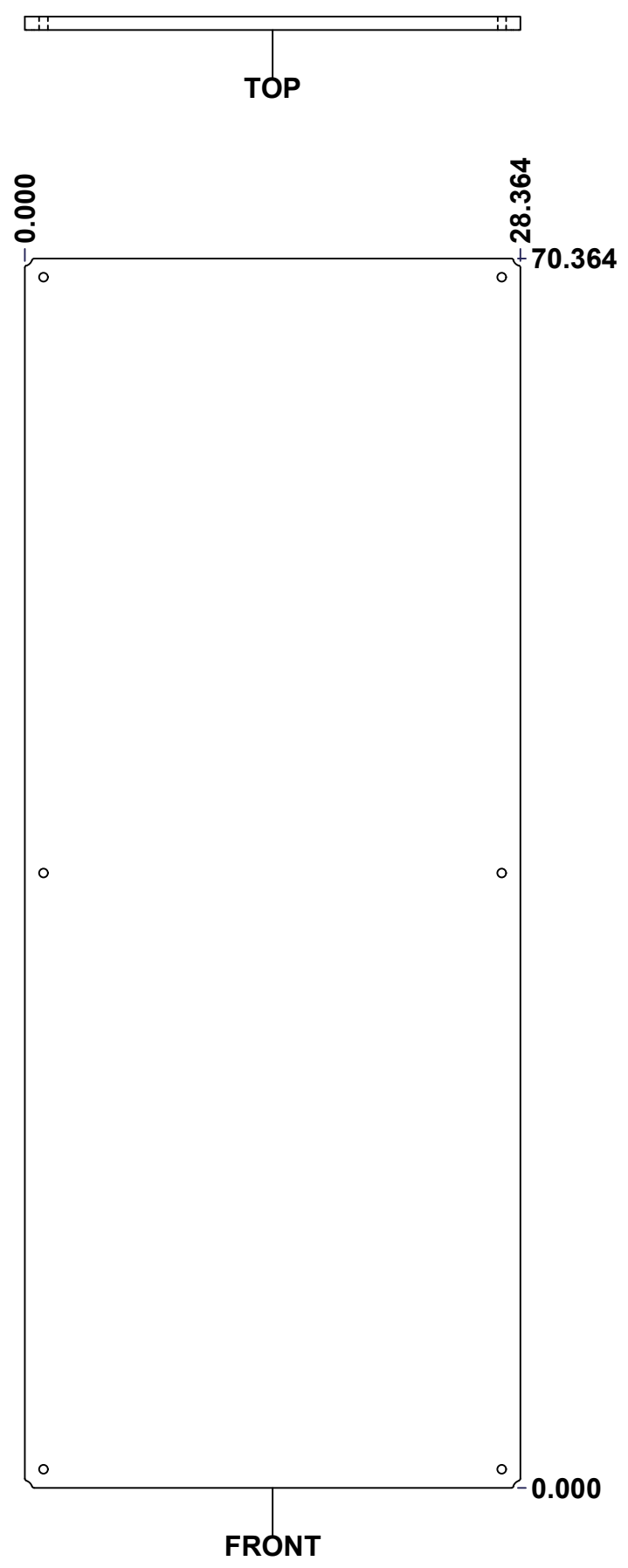

No.	Revisions	Date	By/Par

Isometric View

Tél: (450) 979-4373 Fax: (450) 979-4626 www.exmweb.com		Flatness Aplatissement	
		Max 3.0mm	
Customer Client		Date	
Drawn By Dessiné Par		Date 23-Jan-07	
Material Matière		Polyisocyanurate	
Color Couleur	Aluminum	Finish Fini	N/A
Description			Detail Rev.
5412ESSW 72" x 30" Back Insulation			
Part Number Numéro Pièce		Rev.	11
SEE BILL OF MATERIAL ON LAST PAGE 5412ESSW7230206THNOIPI-B 0			15

This drawing is confidential and must not be reproduced or used without the consent of EXM

Ce dessin est confidentiel et ne doit pas être reproduit ou utilisé sans le consentement de EXM

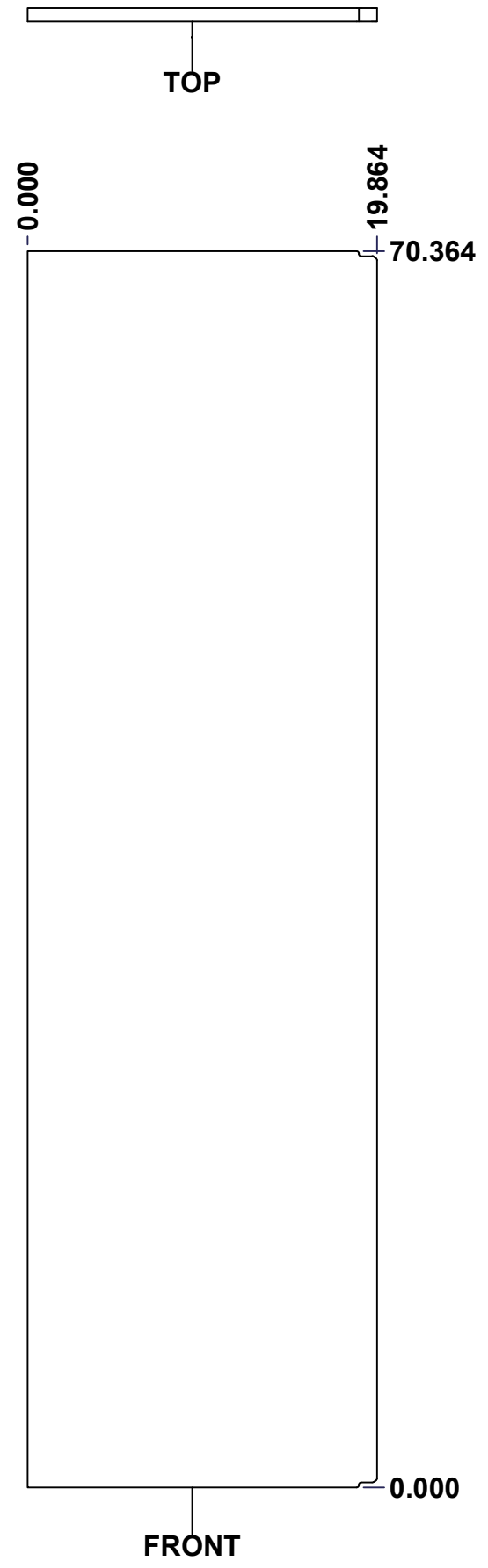

No.	Revisions	Date	By/Par

Isometric View

		Flatness Aplatissement Max 3.0mm	
Tél: (450) 979-4373 Fax: (450) 979-4626 www.exmweb.com		Projection 	
Customer Client		Date	
Drawn By Dessiné Par BoxCad: Patrick Deschenes		Date 23-Jan-07	
Material Matière Polyisocyanurate			
Color Couleur Aluminum		Finish Fini N/A	
Description 5412ESSW 72" x 30" Left Insulation			Detail Rev.
Part Number Numéro Pièce		Rev.	12
SEE BILL OF MATERIAL ON LAST PAGE			5412ESSW7230206THNOIP-LS0

This drawing is confidential and must not be reproduced or used without the consent of EXM

Ce dessin est confidentiel et ne doit pas être reproduit ou utilisé sans le consentement de EXM

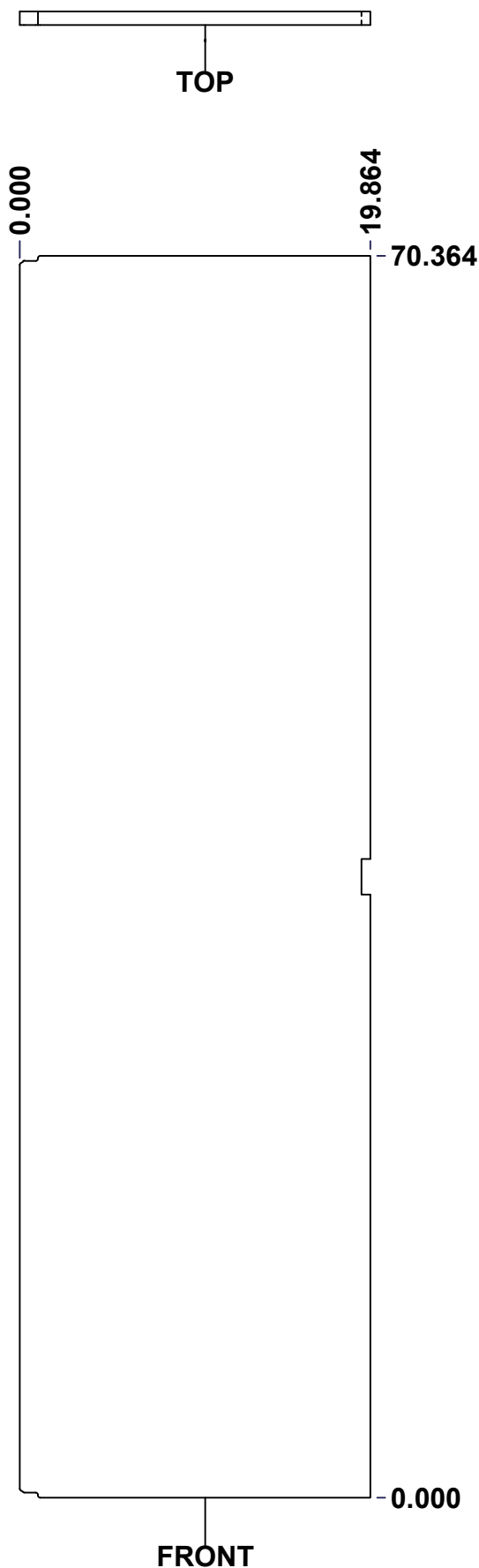

No.	Revisions	Date	By/Par

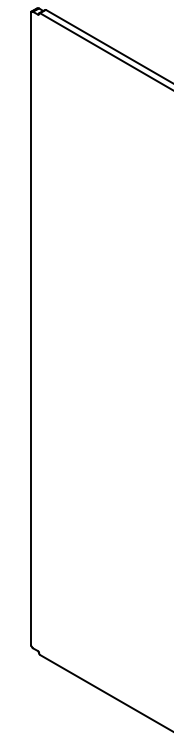

Isometric View

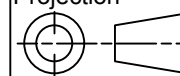

 Tél: (450) 979-4373 Fax: (450) 979-4626 www.exmweb.com		Flatness Aplatissement Max 3.0mm
Projection 		Date 23-Jan-07
Customer Client	Date	
Drawn By Dessiné Par	BoxCad: Patrick Deschenes	Date 23-Jan-07
Material Matière	Polyisocyanurate	
Color Couleur	Aluminum	Finish Fini N/A
Description	Detail Rev.	
5412ESSW 72" x 30" Right Insulation		
Part Number Numéro Pièce	Rev.	13
SEE BILL OF MATERIAL ON LAST PAGE		15

5412ESSW7230206THNOIPI-RS0

This drawing is confidential and must not be reproduced or used without the consent of EXM

Ce dessin est confidentiel et ne doit pas être reproduit ou utilisé sans le consentement de EXM



TOP



FRONT



RIGHT

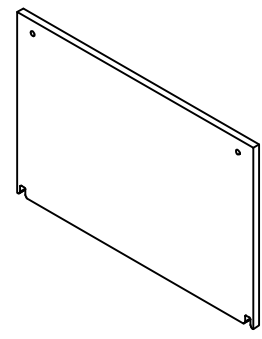

Isometric View



Tél: (450) 979-4373
 Fax: (450) 979-4626
www.exmweb.com

Flatness
 Aplatissement
 Max 3.0mm
 Projection

Customer Client	Date
Drawn By Dessiné Par BoxCad: Patrick Deschenes	Date 23-Jan-07
Material Matière Polyisocyanurate	
Color Couleur Aluminum	Finish Fini N/A

Description
 5412ESSW 72" x 30" Top and Bottom Insulation

Part Number Numéro Pièce	Rev. 14
-----------------------------	---------

SEE BILL OF MATERIAL ON LAST PAGE 5412ESSW7230206THNOIPI-TP0

This drawing is confidential and must not be reproduced or used without the consent of EXM

Ce dessin est confidentiel et ne doit pas être reproduit ou utilisé sans le consentement de EXM

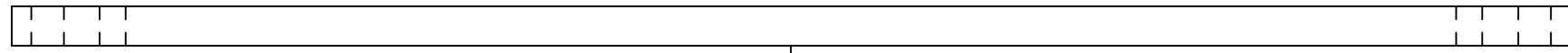

TOP



FRONT

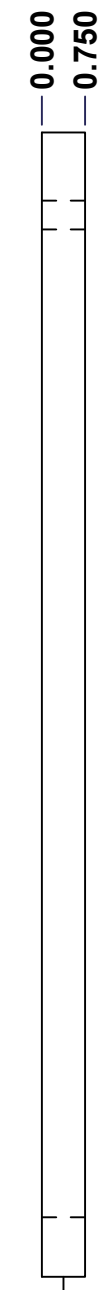

RIGHT

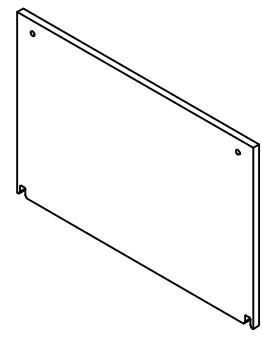

Isometric View



Tél: (450) 979-4373
 Fax: (450) 979-4626
www.exmweb.com

Flatness
 Aplatissement
 Max 3.0mm
 Projection

Customer Client	Date
Drawn By Dessiné Par BoxCad: Patrick Deschenes	Date 23-Jan-07
Material Matière Polyisocyanurate	
Color Couleur Aluminum	Finish Fini N/A

Description 5412ESSW 72" x 30" Top and Bottom Insulation	Detail Rev.
Part Number Numéro Pièce	Rev. 15

SEE BILL OF MATERIAL ON LAST PAGE 5412ESSW7230206THNOIPI-BT0